

Engineering

Land/Site
Development

Municipal
Infrastructure

Environmental/
Water Resources

Traffic/
Transportation

Recreational

Planning

Land/Site
Development

Planning Application
Management

Municipal Planning

Urban Design

Expert Witness
(LPAT)

Wireless Industry

Landscape Architecture

Streetscapes &
Public Amenities

Open Space, Parks &
Recreation

Community &
Residential

Commercial &
Institutional

Environmental
Restoration



Proposed Residential Development 1900-1920 Walkley Road, 2425 Don Reid Drive, 2510 St. Laurent Boulevard, and 2990- 3000 Conroy Road, Ottawa Transportation Impact Assessment

**Proposed Residential Development
1900-1920 Walkley Road, 2425 Don Reid Drive,
2510 St. Laurent Boulevard, and 2990-3000 Conroy Road
Transportation Impact Assessment**

Prepared By:

NOVATECH

Suite 200, 240 Michael Cowpland Drive
Ottawa, Ontario
K2M 1P6

Dated: October 2022

Revised: September 2023

Novatech File: 122040
Ref: R-2022-109

September 29, 2023

City of Ottawa
Planning and Growth Management Department
110 Laurier Ave. W., 4th Floor,
Ottawa, Ontario K1P 1J1

Attention: Mr. Mike Giampa
Senior Engineer, Infrastructure Applications

Dear Mr. Giampa:

**Reference: 1900-1920 Walkley Road, 2425 Don Reid Drive, 2510 St. Laurent Boulevard,
and 2990-3000 Conroy Road**
Revised Transportation Impact Assessment
Novatech File No. 122040

We are pleased to submit the following revised Transportation Impact Assessment (TIA), in support of Zoning By-Law Amendment, Site Plan Control, and Draft Plan of Condominium applications at 1900-1920 Walkley Road, 2425 Don Reid Drive, 2510 St. Laurent Boulevard, and 2990-3000 Conroy Road, for your review and signoff. The structure and format of this report is in accordance with the City of Ottawa's *Transportation Impact Assessment Guidelines* (June 2017).

The original TIA prepared in support of this development was submitted in October 2022. This revised TIA reflects changes in the Site Plan and addresses City comments.

If you have any questions or comments regarding this report, please feel free to contact Brad Byvelds, or the undersigned.

Yours truly,

NOVATECH



Joshua Audia, P.Eng.
Project Engineer | Transportation



TIA Plan Reports

On 14 June 2017, the Council of the City of Ottawa adopted new Transportation Impact Assessment (TIA) Guidelines. In adopting the guidelines, Council established a requirement for those preparing and delivering transportation impact assessments and reports to sign a letter of certification.

Individuals submitting TIA reports will be responsible for all aspects of development-related transportation assessment and reporting, and undertaking such work, in accordance and compliance with the City of Ottawa's Official Plan, the Transportation Master Plan and the Transportation Impact Assessment (2017) Guidelines.

By submitting the attached TIA report (and any associated documents) and signing this document, the individual acknowledges that s/he meets the four criteria listed below.

CERTIFICATION

1. I have reviewed and have a sound understanding of the objectives, needs and requirements of the City of Ottawa's Official Plan, Transportation Master Plan and the Transportation Impact Assessment (2017) Guidelines;
2. I have a sound knowledge of industry standard practice with respect to the preparation of transportation impact assessment reports, including multi modal level of service review;
3. I have substantial experience (more than 5 years) in undertaking and delivering transportation impact studies (analysis, reporting and geometric design) with strong background knowledge in transportation planning, engineering or traffic operations; and
4. I am either a licensed¹ or registered² professional in good standing, whose field of expertise [check appropriate field(s)] is either transportation engineering or transportation planning .

1,2 License of registration body that oversees the profession is required to have a code of conduct and ethics guidelines that will ensure appropriate conduct and representation for transportation planning and/or transportation engineering works.

City Of Ottawa
Infrastructure Services and Community
Sustainability
Planning and Growth Management
110 Laurier Avenue West, 4th fl.
Ottawa, ON K1P 1J1
Tel. : 613-580-2424
Fax: 613-560-6006

Ville d'Ottawa
Services d'infrastructure et Viabilité des
collectivités
Urbanisme et Gestion de la croissance
110, avenue Laurier Ouest
Ottawa (Ontario) K1P 1J1
Tél. : 613-580-2424
Télécopieur: 613-560-6006

Dated at Ottawa this 29th day of September, 2023.
(City)

Name: Brad Byvelds, P.Eng.
(Please Print)

Professional Title: Project Manager, Transportation

B. Byvelds

Signature of Individual certifier that s/he meets the above four criteria

Office Contact Information (Please Print)	
Address:	240 Michael Cowpland Drive, Suite 200
City / Postal Code:	Ottawa, ON, K2M 1P6
Telephone / Extension:	613-254-9643 x 286
E-Mail Address:	b.byvelds@novatech-eng.com

TABLE OF CONTENTS

EXECUTIVE SUMMARY 1

1.0 SCREENING 1

 1.1 INTRODUCTION 1

 1.2 PROPOSED DEVELOPMENT 2

 1.3 SCREENING FORM 2

2.0 SCOPING 3

 2.1 EXISTING CONDITIONS 3

 2.1.1 Roadways 3

 2.1.2 Intersections 4

 2.1.3 Driveways 6

 2.1.4 Pedestrian and Cycling Facilities 7

 2.1.5 Area Traffic Management 7

 2.1.6 Transit 7

 2.1.7 Existing Traffic Volumes 10

 2.1.8 Collision Records 11

 2.2 PLANNED CONDITIONS 13

 2.2.1 Planned Transportation Projects 13

 2.2.2 Other Area Developments 14

 2.3 STUDY AREA AND TIME PERIODS 15

 2.4 EXEMPTIONS REVIEW 15

3.0 FORECASTING 16

 3.1 DEVELOPMENT-GENERATED TRAVEL DEMAND 16

 3.1.1 Trip Generation 16

 3.1.2 Trip Distribution 18

 3.1.3 Trip Assignment 18

 3.2 BACKGROUND TRAFFIC 19

 3.2.1 General Background Growth Rate 19

 3.2.2 Other Area Developments 20

 3.3 FUTURE TRAFFIC CONDITIONS 20

 3.4 DEMAND RATIONALIZATION 24

 3.4.1 Existing Intersection Operations 24

 3.4.2 2024 Background Intersection Operations 26

 3.4.3 2029 Background Intersection Operations 26

4.0 ANALYSIS 27

 4.1 DEVELOPMENT DESIGN 27

 4.1.1 Design for Sustainable Modes 28

 4.1.2 Circulation and Access 29

 4.2 PARKING 29

 4.3 BOUNDARY STREETS 29

 4.4 ACCESS INTERSECTIONS 30

 4.4.1 Access Design 30

 4.4.2 Access Operations 35

 4.5 TRANSPORTATION DEMAND MANAGEMENT 35

 4.5.1 Context for TDM 35

 4.5.2 Need and Opportunity 35

 4.5.3 TDM Program 35

 4.6 NEIGHBOURHOOD TRAFFIC MANAGEMENT 36

 4.7 TRANSIT 36

4.8 INTERSECTION DESIGN..... 38

 4.8.1 Intersection MMLoS Review.....38

 4.8.2 2024 Total Intersection Operations41

 4.8.3 2029 Total Intersection Operations42

5.0 CONCLUSIONS AND RECOMMENDATIONS43

Figures

Figure 1: View of the Subject Site 1

Figure 2: Roadway Network..... 4

Figure 3: Pedestrian and Cycling Network 8

Figure 4: OC Transpo Bus Stop Locations 9

Figure 5: Existing Traffic Volumes..... 10

Figure 6: Site-Generated Traffic Volumes 21

Figure 7: 2024 Other Area Development-Generated Traffic Volumes 21

Figure 8: 2029 Other Area Development-Generated Traffic Volumes 22

Figure 9: 2024 Background Traffic Volumes 22

Figure 10: 2029 Background Traffic Volumes 23

Figure 11: 2024 Total Traffic Volumes 23

Figure 12: 2029 Total Traffic Volumes 24

Figure 13: Intersection Sight Triangles 1 32

Figure 14: Intersection Sight Triangles 2..... 33

Figure 15: Intersection Sight Triangles 3..... 34

Tables

Table 1: OC Transpo Route Information 8

Table 2: OC Transpo Transit Stops..... 9

Table 3: Reported Collisions 11

Table 4: TIA Exemptions..... 15

Table 5: Proposed Townhouses and Apartments – Peak Period Trip Generation 16

Table 6: Proposed Townhouses and Apartments – Peak Period Trips by Mode Share 17

Table 7: Proposed Townhouses and Apartments – Peak Hour Trips by Mode Share 17

Table 8: Proposed Retirement – Peak Hour Trip Generation 17

Table 9: Proposed Retirement – Peak Hour Trips by Mode Share 18

Table 10: Entire Proposed Development – Total Peak Hour Trips..... 18

Table 11: Existing Traffic Operations 25

Table 12: Existing Queues 25

Table 13: 2024 Background Traffic Operations 26

Table 14: 2024 Background Queues..... 26

Table 15: 2029 Background Traffic Operations 27

Table 16: 2029 Background Queues..... 27

Table 17: Required and Proposed Parking..... 29

Table 18: Segment MMLoS Summary..... 29

Table 19: 2024/2029 Access Intersection Operations 35

Table 20: Existing and Projected Transit Utilization..... 37

Table 21: Intersection MMLoS Summary..... 39

Table 22: 2024 Total Traffic Operations 41

Table 23: 2024 Total Queues..... 42

Table 24: 2029 Total Traffic Operations 42

Table 25: 2029 Total Queues..... 42

Appendices

Appendix A: Proposed Site Plan

Appendix B: TIA Screening Form

Appendix C: OC Transpo Route Information

Appendix D: Traffic Count Data

Appendix E: Collision Records

Appendix F: Relevant Excerpts of *TRANS Trip Generation Manual* (WSP, 2020)

Appendix G: Other Area Developments

Appendix H: Strategic Long-Range Model and Intersection Growth Rate Figures

Appendix I: Signal Timing Plans

Appendix J: Existing Synchro Analysis

Appendix K: Background Synchro Analysis

Appendix L: Transportation Demand Management

Appendix M: MMLoS Analysis

Appendix N: Total Synchro Analysis

EXECUTIVE SUMMARY

This Transportation Impact Assessment (TIA) has been prepared in support of Zoning By-Law Amendment, Site Plan Control, and Draft Plan of Condominium applications for the property located at 1900-1920 Walkley Road, 2425 Don Reid Drive, 2510 St. Laurent Boulevard, and 2990-3000 Conroy Road (referred to as 2510 St. Laurent Boulevard in this TIA). The subject site is approximately 5.89 hectares in size and is currently vacant land. The subject site is surrounded by the following:

- Walkley Road, followed by parkland to the north,
- St. Laurent Boulevard, followed by commercial uses to the south,
- Conroy Road, followed by commercial uses to the east, and
- Don Reid Drive, followed by commercial uses to the west.

The proposed development will consist of 160 townhouse dwellings. Access to the townhouses will be provided via two driveways to St. Laurent Boulevard and one driveway to Don Reid Drive. The development will be constructed in a single phase, with a buildout year of 2024.

The proponent owns additional lands north of the proposed development which includes the subject site's entire frontage to Walkley Road. These lands are anticipated to include a retirement home with approximately 150 units and an apartment building with approximately 100 units. Access to the development block is anticipated to occur through a right-in/right-out (RIRO) access to Walkley Road and an all-movement access through the adjacent signalized commercial access to Walkley Road. In total, 410 dwellings are proposed for the entire subject site. The boundaries of the subject site currently include most of the westernmost commercial driveway to 1950 Walkley Road and the southernmost commercial driveway to 2980 Conroy Road. These driveways are intended to continue serving the adjacent commercial plaza and conveying the affected lands to the proper addresses will be resolved through this application process.

The boundaries of the subject site currently include most of the westernmost commercial driveway to 1950 Walkley Road and the southernmost commercial driveway to 2980 Conroy Road. These driveways are intended to continue serving the adjacent commercial plaza and conveying the affected lands to the proper addresses will be resolved through this application process.

The subject site is located within the 'Evolving Neighbourhood' overlay, and is designated as 'Corridor – Minor' (Walkley Road) and 'Neighbourhood' on Schedule B3 of the City of Ottawa's Official Plan (2021, Council Adopted). The current zoning for the property is 'General Mixed Use' (GM[1327]), and the site is not located within any Community Design Plan or Secondary Plan areas. A Zoning By-Law Amendment is required to remove the site and use-specific zone provisions of Exception 1327. The proposed residential uses are permitted by the parent GM zone. The retirement home and apartment building located at the northwest corner of the proponent's lands will be subject to a separate Site Plan Control application in the future, but is included in the current Zoning By-Law Amendment application. As such, this TIA will consider the traffic generated by the future retirement home/apartments, and the future Site Plan Control application for the proposed retirement home/apartments will include details on the on-site design aspects (such as access locations, development design, and parking provisions).

The study area for this report includes the boundary roadways Walkley Road, Conroy Road, St. Laurent Boulevard, and Don Reid Drive, as well as the following intersections:

- Walkley Road/Don Reid Drive/Ryder Street
- Walkley Road/160m West of Conroy Road
- Walkley Road/Conroy Road
- St. Laurent Boulevard/Conroy Road
- St. Laurent Boulevard/Don Reid Drive

The selected time periods for the analysis are the weekday AM and PM peak hours, as they represent the 'worst case' combination of site generated traffic and adjacent street traffic. Analysis will be completed for the 2024 build-out year and 2029 horizon year.

The conclusions and recommendations of this TIA can be summarized as follows:

Forecasting

- The proposed development is estimated to generate 170 person trips (including 67 vehicle trips) during the AM peak hour, and 193 person trips (including 79 vehicle trips) during the PM peak hour.

Development Design and Parking

- In general, the proposed development includes a pavement width of 6.5m to 6.7m for on-site roadways with perpendicular parking spaces or no on-street parking. Parallel parking spaces are provided on the south side of Street 1 (adjacent to the public park), the east side of Street 1 (adjacent to 2500 St. Laurent Boulevard), and on the north side of Street 3 (adjacent to the commercial access serving 1950 Walkley Road and 2980 Conroy Road). These parallel parking spaces are provided as lay-bys, to maintain a narrower pavement width outside of these spaces and reduce the operating speed of vehicles on-site.
- On-site concrete sidewalks will be provided along the south side of Street 1 between Don Reid Drive and Street 3, the east side of Street 1, the south side of Street 3, and the east side of the additional lands to the north. Midblock pathways will also be provided between the proposed public park and Street 2, and between Street 2 and Street 1 at Street 3. These sidewalks will connect the proposed development to the proposed parkland fronting Don Reid Drive, and to the existing sidewalks along Conroy Road, St. Laurent Boulevard, and Don Reid Drive.
- Any required TDM-supportive design and infrastructure measures in the TDM checklist that are relevant to townhouse developments have been met.
- Garbage collection will take place curbside in front of the proposed dwellings. The on-site fire route will include all private roadways within the subject site.
- The minimum parking requirements will be met. As every proposed dwelling will include their own garage, the ZBL does not identify any minimum bicycle parking requirements.

Boundary Streets

- The results of the segment multi-modal level of service (MMLOS) analysis can be summarized as follows:
 - No boundary street meets the target pedestrian level of service (PLOS);
 - No boundary street meets the target bicycle level of service (BLOS);
 - Conroy Road meets the target transit level of service (TLOS), while Walkley Road does not;
 - All boundary streets meet the target truck level of service (TkLOS).
- Both sides of Walkley Road and Conroy Road do not meet the target PLOS C. Walkley Road can achieve the target PLOS C and Conroy Road can achieve a PLOS D by implementing sidewalks with a minimum width of 2.0m and a minimum boulevard width of 2.0m. This is identified for the City's consideration.
- The south side of St. Laurent Boulevard and west side of Don Reid Drive do not meet the target PLOS C, as sidewalks are only provided on one side of each roadway. Implementing curbside sidewalks with a minimum width of 1.8m are sufficient to achieve the target PLOS. This is identified for the City's consideration. The existing sidewalks on St. Laurent Boulevard and Don Reid Drive meet the target PLOS C, and therefore no recommendations for these sidewalks are identified. Any sidewalks that need to be reconstructed as a result of the proposed development will be reinstated to a width of 1.8m.
- Walkley Road does not meet the target BLOS B. The target BLOS B can only be achieved through the implementation of physically separated bikeways along Walkley Road. This is identified for the City's consideration.
- St. Laurent Boulevard and Don Reid Drive do not meet the target BLOS B. The target BLOS B can be achieved by providing curbside bike lanes with a minimum width of 1.5m, and reducing the operating speed to 50 km/h.
- Walkley Road does not meet the target TLOS B, which is achieved by providing bus lanes with no or limited parking/driveway friction. It is anticipated that this target will be met upon completion of the Baseline/Heron/Walkley/St. Laurent BRT project, which is anticipated to occur beyond 2031.

Access Intersections

- The proposed development includes two full-movement accesses to St. Laurent Boulevard and one full-movement access to Don Reid Drive. Depressed curbs and continuous sidewalks are proposed along the entirety of each access, in accordance with City standards. The design of each access meets the relevant provisions of the City's *Private Approach By-Law*.
- The proposed access to Don Reid Drive will have clear sightlines to Walkley Road to the north and St. Laurent Boulevard to the south. The proposed accesses to St. Laurent Boulevard are located on the inside of a slight curve, but will still achieve the sightlines recommended by the Transportation Association of Canada (TAC), provided that any vegetation within the ROW of St. Laurent Boulevard is trimmed and maintained. Therefore, no sightline concerns are anticipated.

- The proposed accesses to St. Laurent Boulevard and Don Reid Drive are anticipated to operate with an acceptable vehicular level of service for the buildout year 2024 and horizon year 2029.

Transportation Demand Management

- A review of the City's *TDM Measures Checklist* has been conducted by the proponent, who has committed to providing the following TDM measures at the sales centre:
 - Provide local area maps with walking/cycling access routes and key destinations;
 - Provide relevant transit schedules and route maps;
 - Provide a multimodal travel option information package.

Neighbourhood Traffic Management

- The peak hour and daily NTM thresholds for both St. Laurent Boulevard and Don Reid Drive are exceeded by the existing traffic volumes. Since St. Laurent Boulevard and Don Reid Drive primarily serve industrial, commercial, or office uses, no neighbourhood traffic management measures have been recommended as part of this proposed development.

Transit

- The proposed development is anticipated to generate 52 AM peak hour transit trips, (including 35 boarding and 17 alighting), and 55 PM peak hour transit trips (including 25 boarding and 30 alighting). These additional transit trips are not anticipated to require more frequent service at any stops within the study area.

Intersection MMLOS

- The results of the intersection MMLOS analysis can be summarized as follows:
 - No signalized intersections meet the target PLOS;
 - No signalized intersections meet the target BLOS;
 - Walkley Road/160m West of Conroy Road and St. Laurent Boulevard/Conroy Road meets the target TLOS, while Walkley Road/Don Reid Drive/Ryder Street and Walkley Road/Conroy Road do not;
 - Walkley Road/Conroy Road meets the target TkLOS, while Walkley Road/Don Reid Drive/Ryder Street, Walkley Road/160m West of Conroy Road, and St. Laurent Boulevard/Conroy Road do not.
- All approaches at the study area intersections do not meet the target PLOS C. There is limited opportunity in improving the PLOS at each approach without reducing the number of travel lanes or removing right turn channels where applicable. The south and east approaches at Walkley Road/Conroy Road meet the City's vehicle/pedestrian conflict threshold to consider zebra-striped crosswalks.
- For approaches with failing BLOS based on left turn characteristics, the target BLOS can be achieved by implementing two-stage, left-turn cycling facilities. Implementing bike boxes would also require restricting right turns on red (RTOR). This is identified for the City's consideration.

- The south approach of Walkley Road/160m West of Conroy Road, the south and west approaches of Walkley Road/Conroy Road, and the east and west approaches of St. Laurent Boulevard/Conroy Road do not meet the target BLOS based on right turn characteristics. The provision of separated cycling facilities on Walkley Road and the east side of Conroy Road, and bike lanes on St. Laurent Boulevard is identified for the City's consideration.
- The north and west approaches of Walkley Road/Don Reid Drive/Ryder Street and all approaches of Walkley Road/Conroy Road do not meet the target TLOS B. It is anticipated that the target TLOS will be met on Walkley Road upon completion of the Baseline/Heron/Walkley/St. Laurent BRT project, and on Conroy Road with the implementation of isolated transit priority measures. No recommendations are identified for Ryder Street (i.e. a local roadway with no transit priority designation).
- Any approaches that do not meet the target TkLOS represent right turns into private approaches or onto local/collector roadways with no truck route designation, and therefore no recommendations are identified.

Existing Traffic Operations

- The eastbound through and westbound left turn movements at Walkley Road/Conroy Road operate at an Auto LOS E during the PM peak hour.
- During the AM peak hour, the Synchro analysis identifies that the maximum (95th-percentile) queue lengths of the westbound through movements at Walkley Road/Don Reid Drive/Ryder Street and Walkley Road/160m West of Conroy Road extend into the upstream intersections on Walkley Road.
- During the PM peak hour, the Synchro analysis identified that the maximum queue length of the northbound left turn movement at Walkley Road/Don Reid Drive/Ryder Street exceeds the storage length of the auxiliary northbound left turn, but is contained within the taper. The maximum queue length of the eastbound through movement at Walkley Road/Conroy Road extends into the upstream intersection on Walkley Road.

Background Traffic Operations

- Compared to the existing conditions, improvements in some movements is due to differences in the Peak Hour Factor parameter (0.9 in existing conditions and 1.0 in future conditions, per the *2017 TIA Guidelines*).
- The eastbound through movement at Walkley Road/Conroy Road operates at an Auto LOS E during the PM peak hour. Increasing the green time for the eastbound-westbound phases has been reviewed, and the analysis indicates that this mitigation allows the eastbound through movement to operate at the target Auto LOS D.

Total Traffic Operations

- Compared to the future background traffic conditions, site-generated traffic is anticipated to have marginal impacts on traffic operations within the study area.
- Based on the foregoing, the proposed development is recommended from a transportation perspective.

1.0 SCREENING

1.1 Introduction

This Transportation Impact Assessment (TIA) has been prepared in support of Zoning By-Law Amendment, Site Plan Control, and Draft Plan of Condominium applications for the property located at 1900-1920 Walkley Road, 2425 Don Reid Drive, 2510 St. Laurent Boulevard, and 2990-3000 Conroy Road (referred to as 2510 St. Laurent Boulevard in this TIA). The subject site is approximately 5.89 hectares in size and is currently vacant land.

The subject site is surrounded by the following:

- Walkley Road, followed by parkland to the north,
- St. Laurent Boulevard, followed by commercial uses to the south,
- Conroy Road, followed by commercial uses to the east, and
- Don Reid Drive, followed by commercial uses to the west.

An aerial of the vicinity around the subject site is provided in **Figure 1**.

Figure 1: View of the Subject Site



1.2 Proposed Development

The proposed development will consist of 160 townhouse dwellings. Access to the townhouses will be provided via two driveways to St. Laurent Boulevard and one driveway to Don Reid Drive. The development will be constructed in a single phase, with a buildout year of 2024.

The proponent owns additional lands north of the proposed development which includes the subject site's entire frontage to Walkley Road. These lands are anticipated to include a retirement home with approximately 150 units and an apartment building with approximately 100 units. Access to the development block is anticipated to occur through a right-in/right-out (RIRO) access to Walkley Road and an all-movement access through the adjacent signalized commercial access to Walkley Road. In total, 410 dwellings are proposed for the entire subject site. The boundaries of the subject site currently include most of the westernmost commercial driveway to 1950 Walkley Road and the southernmost commercial driveway to 2980 Conroy Road. These driveways are intended to continue serving the adjacent commercial plaza and conveying the affected lands to the proper addresses will be resolved through this application process.

The subject site is located within the 'Evolving Neighbourhood' overlay, and is designated as 'Corridor – Minor' (Walkley Road) and 'Neighbourhood' on Schedule B3 of the City of Ottawa's Official Plan. The current zoning for the property is 'General Mixed Use' (GM[1327]), and the site is not located within any Community Design Plan or Secondary Plan areas. A Zoning By-Law Amendment is required to remove the site and use-specific zone provisions of Exception 1327. The proposed residential uses are permitted by the parent GM zone. The retirement home and apartment building located at the northwest corner of the proponent's lands will be subject to a separate Site Plan Control application in the future, but is included in the current Zoning By-Law Amendment application. As such, this TIA will consider the traffic generated by the future retirement home/apartments, and the future Site Plan Control application for the proposed retirement home/apartments will include details on the on-site design aspects (such as access locations, development design, and parking provisions).

A copy of the proposed site plan is included in **Appendix A**.

1.3 Screening Form

The City's *2017 TIA Guidelines* identify three triggers for completing a TIA report, including trip generation, location, and safety. The criteria for each trigger are outlined in the City's TIA Screening Form, which is included in **Appendix B**. The trigger results are as follows:

- Trip Generation Trigger – The development is anticipated to generate over 60 peak hour person trips; further assessment is **required** based on this trigger.
- Location Triggers – The development does not propose a new connection to a boundary street designated in the City's Transit Priority, Rapid Transit, or Spine Bicycle Networks, and the development is not located in a Design Priority Area or Transit-Oriented Development zone; further assessment is **not required** based on this trigger.
- Safety Triggers – The proposed development will include a driveway within the area of influence of a signalized intersection, and will be located within the auxiliary lane of an intersection; further assessment is **required** based on this trigger.

2.0 SCOPING

2.1 Existing Conditions

2.1.1 Roadways

All roadways within the study area fall under the jurisdiction of the City of Ottawa.

Walkley Road is an arterial roadway that generally runs on an east-west alignment between Riverside Drive and Ramsayville Road. Within the study area, Walkley Road has a four-lane divided urban cross-section, concrete sidewalks on both sides of the roadway, and a posted speed limit of 50 km/h. The roadway is classified as a truck route, allowing full loads. On-street parking is not permitted. The City's Official Plan identifies a right-of-way (ROW) protection of 44.5m for Walkley Road between Heron Road and the Greenbelt boundary. A ROW widening may be required.

Conroy Road is an arterial roadway that generally runs on a north-south alignment between Walkley Road and Bank Street. Within the study area, Conroy Road has a five-lane divided urban cross-section, a concrete sidewalk on the east side of the roadway, an asphalt multi-use pathway on the west side of the roadway, and a posted speed limit of 60 km/h. The roadway is classified as a truck route, allowing full loads. On-street parking is not permitted. The City's Official Plan identifies a ROW protection of 44.5m for Conroy Road between Walkley Road and the Greenbelt boundary. A ROW widening is not required.

St. Laurent Boulevard is a curvilinear collector roadway that runs between Don Reid Drive and Russell Road. Within the study area, St. Laurent Boulevard has a two-lane undivided urban cross-section, a concrete sidewalk on the north side of the roadway, and a posted speed limit of 50 km/h. The roadway is not classified as a truck route. On-street parking is not permitted. The City's Official Plan does not identify a ROW protection for this section of St. Laurent Boulevard, and therefore no ROW widening is required.

Don Reid Drive is a curvilinear roadway that starts at Walkley Road and terminates approximately 830m southwest of the intersection of Walkley Road/Don Reid Drive/Ryder Street. Don Reid Drive is classified as a collector roadway between Walkley Road and St. Laurent Boulevard, and as a local roadway south of St. Laurent Boulevard. Within the study area, Don Reid Drive has a two-lane undivided urban cross-section, a concrete sidewalk on the east side of the roadway, and an unposted speed limit of 50 km/h. The roadway is not classified as a truck route. On-street parking is not permitted. The City's Official Plan does not identify a ROW protection for Don Reid Drive, and therefore no ROW widening is required.

Ryder Street is a local roadway that generally runs on a north-south alignment between Walkley Road and Featherston Drive. Within the study area, Ryder Street has a two-lane undivided urban cross-section, a concrete sidewalk on the east side of the roadway, and an unposted speed limit of 50 km/h. The roadway is not classified as a truck route. On-street parking is permitted in select areas on the west side of the roadway from April 1 to November 30.

The roadways of the greater area surrounding the subject site is illustrated in **Figure 2**.

Figure 2: Roadway Network

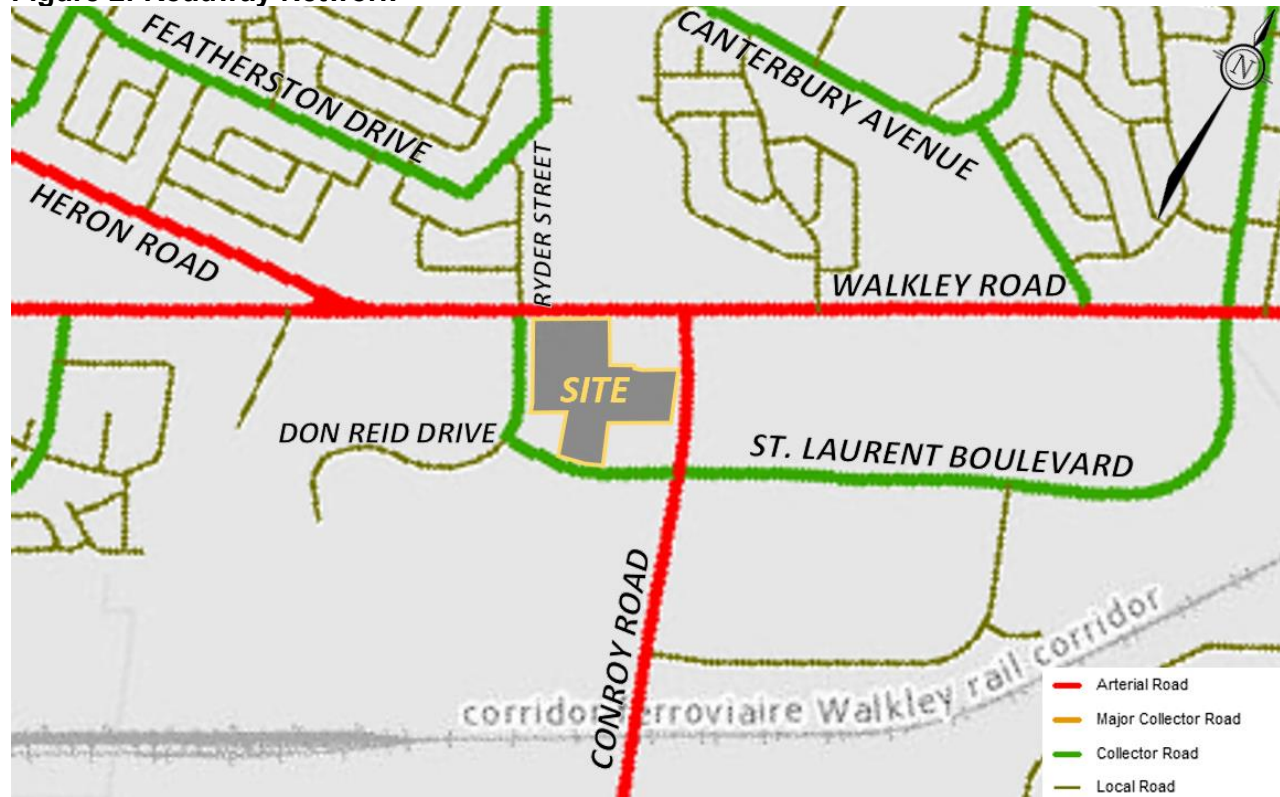

2.1.2 Intersections

Walkley Road/Don Reid Drive/Ryder Street

- Signalized four-legged intersection
- North Approach (Ryder Street): one left turn lane and one shared through/right turn lane
- South Approach (Don Reid Drive): one left turn lane and one right turn lane (northbound through movement is restricted, except for authorized vehicles and cyclists)
- East/West Approaches (Walkley Road): one left turn lane, one through lane, and one shared through/right turn lane
- Standard crosswalks are provided on all approaches



Walkley Road/160m West of Conroy Road

- Signalized three-legged intersection
- South Approach (Access to 1950 Walkley Road): one left turn lane and one right turn lane
- East Approach (Walkley Road): one left turn lane and two through lanes
- West Approach (Walkley Road): two through lanes and one right turn lane
- Standard crosswalks are provided on all approaches
- Pocket bike lane is provided on west approach



Walkley Road/Conroy Road

- Signalized three-legged intersection
- South Approach (Conroy Road): two left turn lanes and one channelized right turn lane
- East Approach (Walkley Road): two left turn lanes and two through lanes
- West Approach (Walkley Road): two through lanes and one channelized right turn lane
- Standard crosswalks are provided on all approaches
- Pocket bike lanes are provided on south and west approaches



St. Laurent Boulevard/Conroy Road

- Signalized four-legged intersection
- North Approach (Conroy Road): one slotted left turn lane, one through lane, and one shared through/right turn lane
- South Approach (Conroy Road): one left turn lane, two through lanes, and one shared through/right turn lane
- East Approach (St. Laurent Boulevard): one left turn lane, one through lane, and one right turn lane
- West Approach (St. Laurent Boulevard): one left turn lane, one through lanes, and one channelized right turn lane
- Standard crosswalks are provided on all approaches
- Bike lanes are provided on north and south approaches

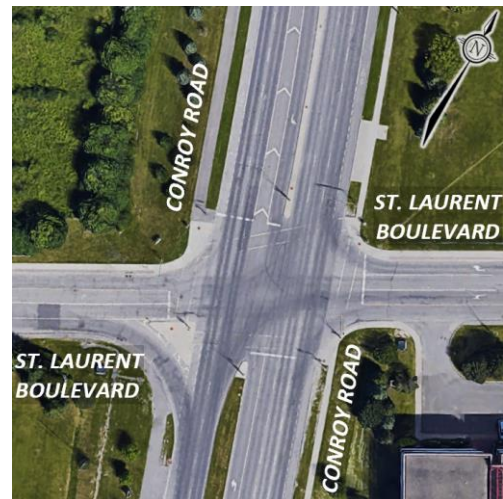

St. Laurent Boulevard/Don Reid Drive

- Unsignalized three-legged intersection
- Stop-controlled on St. Laurent Boulevard
- North Approach (Don Reid Drive): one shared left turn/through lane
- South Approach (Don Reid Drive): one through lane and one channelized right turn lane
- East Approach (St. Laurent Boulevard): one left turn lane and one channelized right turn lane
- Standard crosswalk is provided on east approach



2.1.3 Driveways

A review of the existing adjacent driveways (i.e. accesses within 200m of the subject site, per the 2017 TIA Guidelines) along the boundary roads are provided below.

Walkley Road, North Side

- 11 driveway to residences at 1845, 1847, 1849, 1853, 1855, 1857, 1859, 1863, 1865, 1867, 1869, 1871, 1873, 1875, 1877, 1883, 1885, 1897, & 1899 Walkley Road

Conroy Road, East Side

- One driveway to commercial uses at 2020 Walkley Road

St. Laurent Boulevard, North Side

- One driveway to commercial uses at 2490 and 2500 St. Laurent Boulevard
- One driveway to commercial uses at 2520 St. Laurent Boulevard

Don Reid Drive, East Side

- One driveway to commercial/industrial uses at 2455 Don Reid Drive

Walkley Road, South Side

- Three driveways to commercial uses and a gas station at 1950 and 1970 Walkley Road

Conroy Road, West Side

- Two driveways to commercial uses and a gas station at 1970 Walkley Road and 2980 Conroy Road
- One driveway to commercial uses at 2490 and 2500 St. Laurent Boulevard

St. Laurent Boulevard, South Side

- Four driveways to commercial/industrial uses or government offices at 2505, 2507, 2515, & 2525 St. Laurent Boulevard and 3030 Conroy Road

Don Reid Drive, West Side

- One driveway to an early years centre at 2330 Don Reid Drive
- Two driveways to commercial/industrial uses at 2410 and 2420 Don Reid Drive

2.1.4 Pedestrian and Cycling Facilities

Sidewalks are provided on both sides of Walkley Road, on the north side of St. Laurent Boulevard, and on the east side of Conroy Road, Don Reid Drive, and Ryder Street. A National Capital Commission (NCC) asphalt multi-use pathway (MUP) is provided on the north side of Walkley Road, which continues as a City of Ottawa MUP on the west side of Conroy Road. This pathway generally runs on a north-south alignment between Smyth Road at Roger Guindon Avenue (north of the study area) and Conroy Road at Hunt Club Road (south of the study area).

In the City's primary cycling network, Walkley Road and Conroy Road are classified as Spine Routes, while St. Laurent Boulevard, Ryder Street, and Don Reid Drive between Walkley Road and St. Laurent Boulevard are classified as Local Routes. The MUPs described above are shown in the cycling network as a Major Pathway. Bike lanes are provided along Conroy Road.

The NCC MUP connecting Smyth Road and Hunt Club, the entirety of the City's MUP along Conroy Road, and the section of Walkley Road between Heron Road and Conroy Road are all designated in the City's Crosstown Bikeway network.

The pedestrian and cycling network of the greater area surrounding the subject site is illustrated in **Figure 3**.

2.1.5 Area Traffic Management

There are no Area Traffic Management (ATM) studies within the study area that have been completed or are currently in progress.

Signage on Ryder Street indicates that the residential neighbourhood north of Walkley Road is a 'traffic calmed neighbourhood.' Flex posts and painted islands have been implemented in select curbside locations on Ryder Street. North of the study area, speed humps, bulbouts, and speed boards have been implemented on Featherston Drive north of Ryder Street.

2.1.6 Transit

A summary of the various OC Transpo routes which serve the study area is included in **Table 1**. The locations of bus stops in the vicinity of the subject site are described in **Table 2**, and are shown in **Figure 4**.

Detailed route information and an excerpt from the OC Transpo System Map are included in **Appendix C**.

Figure 3: Pedestrian and Cycling Network

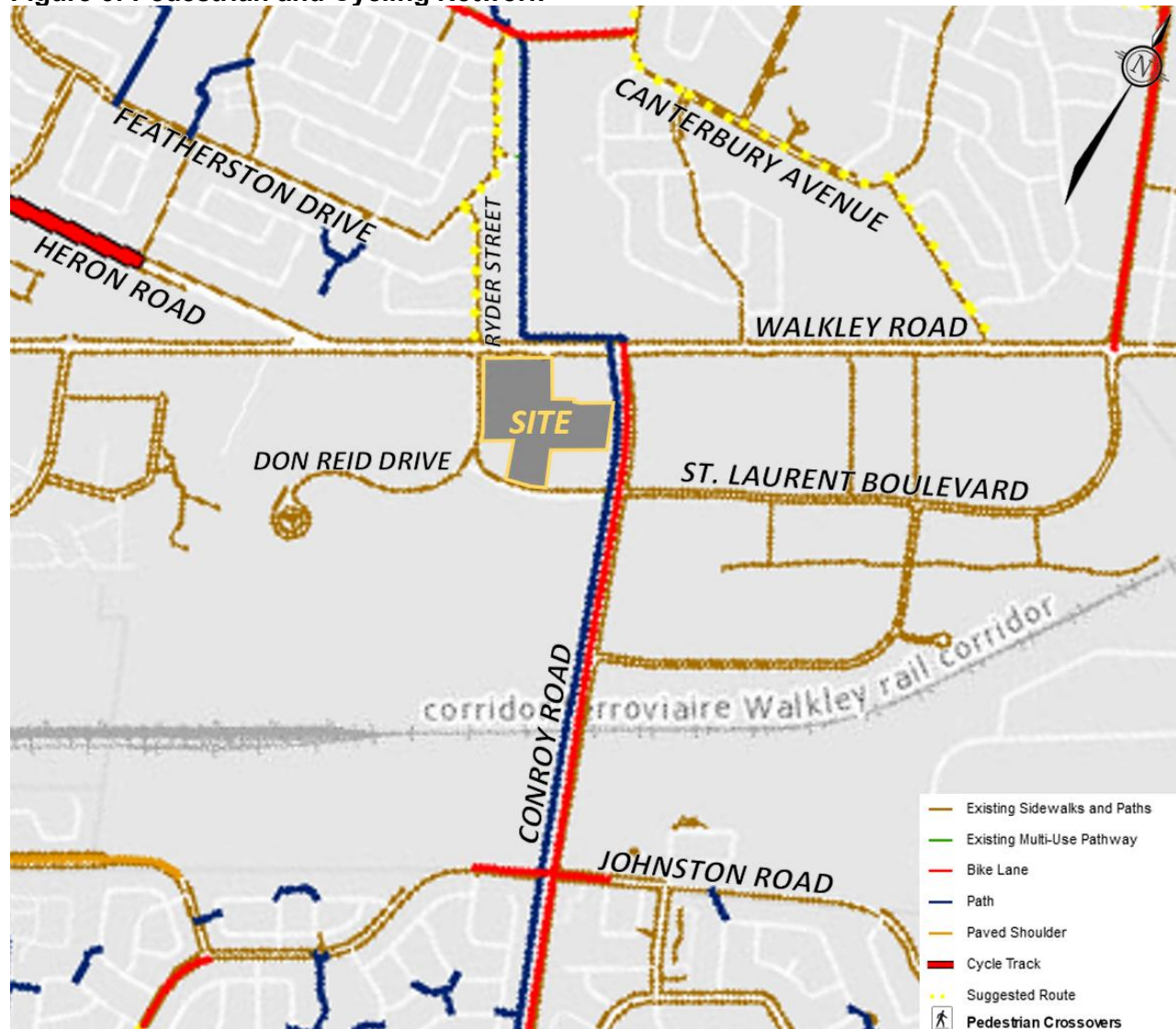

Table 1: OC Transpo Route Information

Route	From ↔ To	Frequency
40	St. Laurent ↔ Greenboro	All day service, seven days a week; 15- to 30-minute headways
46	Hurdman ↔ Billings Bridge	All day service, seven days a week; 30-minute headways
140	Heron Park ↔ Billings Bridge	Limited service during the day, Monday to Saturday; 30-minute headways
291	Hurdman ↔ Herongate	Peak period service, weekdays only; 30-minute headways in peak direction only
644	Canterbury ↔ Greenboro	Service at select times on school days only
649	Hillcrest ↔ Greenboro	Service at select times on school days only
689	Omer-Deslauriers ↔ Billings Bridge	Service at select times on school days only

Table 2: OC Transpo Transit Stops

Stop	Location	Routes Served
#1321	East side of Conroy Road, south of St. Laurent Boulevard	40, 644, 649
#1899	South side of Walkley Road, east of Harding Road	46, 644, 649
#2344	West side of Conroy Road, south of St. Laurent Boulevard	40, 644, 649
#4307	North side of St. Laurent Boulevard, east of Conroy Road	40
#4311	South side of St. Laurent Boulevard, east of Conroy Road	40
#6927	South side of Walkley Road, midblock between Don Reid Drive and 160m West of Conroy Road	46, 689
#7200	South side of Walkley Road, west of Holly Lane	46, 689
#7202	North side of Walkley Road, west of Holly Lane	46, 140, 291, 689
#7281	North side of Walkley Road, midblock between Conroy Road and 160m West of Conroy Road	46, 689
#7282	South side of Walkley Road, east of Conroy Road	46, 644, 649
#7283	North side of Walkley Road, midblock between Heron Road and Ryder Street	46, 140, 291, 689
#8324	North side of Walkley Road, west of Harding Road	46, 644, 649
#8388	South side of Walkley Road, midblock between Heron Road and Don Reid Drive	46, 291, 689
#8391	North side of Walkley Road, west of Ryder Street	46, 140, 291, 689
#8398	East side of Ryder Street, north of Walkley Road	291

Figure 4: OC Transpo Bus Stop Locations



2.1.7 Existing Traffic Volumes

Weekday traffic counts completed by the City of Ottawa or coordinated by Novatech were used to determine the existing pedestrian, cyclist, and vehicular traffic volumes at the study area intersections. These counts were completed on the dates listed below:

- Walkley Road/Don Reid Drive/Ryder Street November 29, 2016 (City)
- Walkley Road/160m West of Conroy Road January 8, 2019 (City)
- Walkley Road/Conroy Road February 22, 2018 (City)
- St. Laurent Boulevard/Conroy Road June 1, 2017 (City)
- St. Laurent Boulevard/Don Reid Drive June 8, 2022 (Nova)

It is noted that the City has traffic count data from January 2022 for Walkley Road/Don Reid Drive/Ryder Street, which was collected at a time when restrictions related to the COVID-19 pandemic were in place. Comparing the 2022 data to the 2016 data, peak hour volumes at all approaches have decreased by approximately 20% to 40%, and are not consistent with the traffic volumes observed at the other study area intersections. Therefore, the 2016 count data at Walkley Road/Don Reid Drive/Ryder Street has been considered in this TIA.

All traffic count data previously discussed are included in **Appendix D**. Traffic volumes within the study area are shown in **Figure 5**.

Figure 5: Existing Traffic Volumes

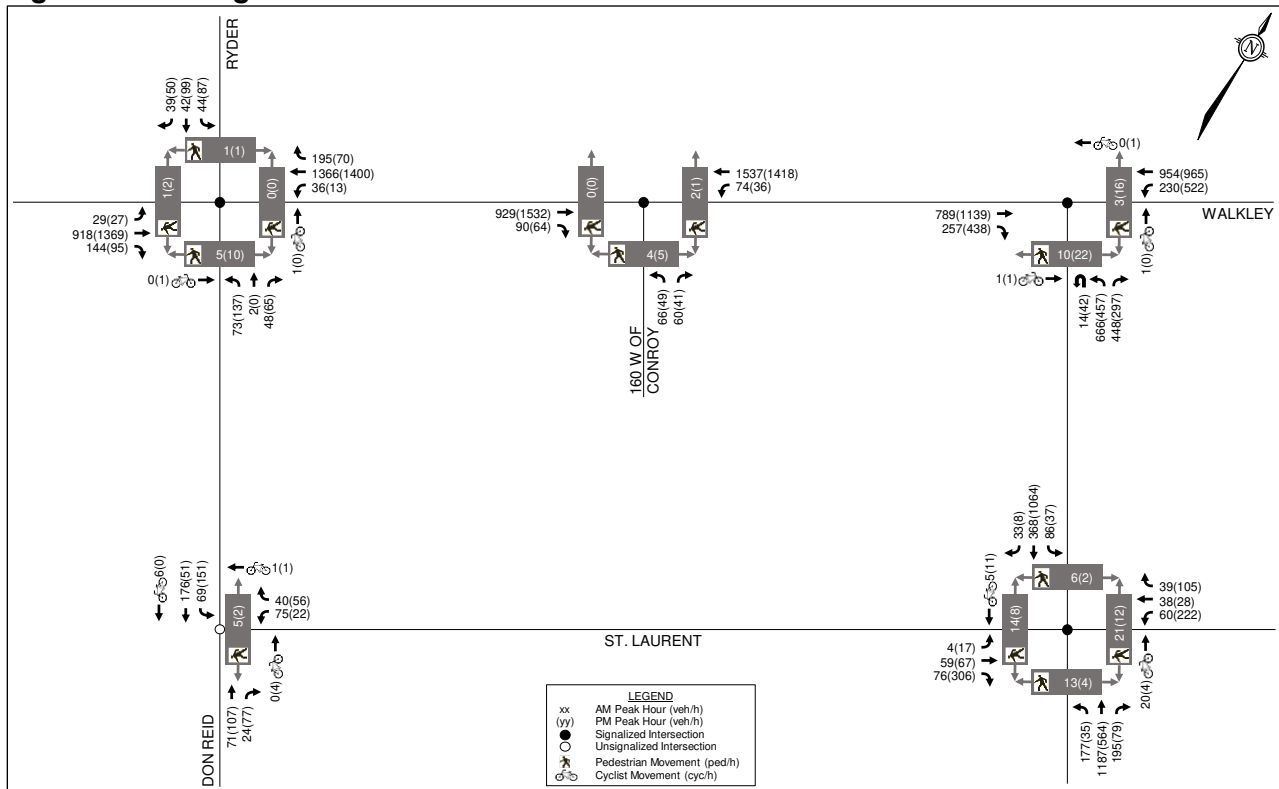

Based on the traffic count data above, the approximate average annual daily traffic (AADT) volumes for the boundary streets can be summarized as follows:

- Walkley Road (Don Reid Drive/Ryder Street to Conroy Road): 38,710 vpd;
- Conroy Road (Walkley Road to St. Laurent Boulevard): 18,580 vpd;
- St. Laurent Boulevard (Don Reid Drive to Conroy Road): 3,930 vpd;
- Don Reid Drive (Walkley Road to St. Laurent Boulevard): 4,330 vpd.

2.1.8 Collision Records

Historical collision data from the last five years was obtained from the City’s Public Works and Service Department for the study area intersections and midblock segments. Copies of the collision summary reports are included in **Appendix E**.

The collision data has been evaluated to determine if there are any identifiable collision patterns, which are defined in the *2017 TIA Guidelines* as ‘more than six collisions in five years’ for any one movement. The number of collisions at each intersection from January 1, 2016 to December 31, 2020 is summarized in **Table 3**.

Table 3: Reported Collisions

Intersection or Street Segment	Impact Types						Total
	Approach	Angle	Rear End	Sideswipe	Turning Mvmt	SMV ⁽¹⁾ /Other	
Walkley Road/ Don Reid Drive/Ryder Street	1	17	13	3	1	2	37
Walkley Road/ 160m West of Conroy Road	-	-	5	-	4	2	11
Walkley Road/ Conroy Road	-	4	51	11	4	4	74
St. Laurent Boulevard/ Conroy Road	-	7	10	3	2	-	22
St. Laurent Boulevard/ Don Reid Drive	-	1	-	-	-	-	1
Walkley Road btwn Don Reid Drive & 160m West of Conroy Road	-	-	4	1	-	-	5
Walkley Road btwn Conroy Road & 160m West of Conroy Road	-	2	4	-	1	-	7
Conroy Road btwn Walkley Road & St. Laurent Boulevard	-	-	1	1	-	1	3
St. Laurent Boulevard btwn Conroy Road & Don Reid Drive	-	1	-	-	1	-	2
Don Reid Drive btwn Walkley Road & St. Laurent Boulevard	-	-	-	-	-	-	0

1. SMV = Single Motor Vehicle

Walkley Road/Don Reid Drive/Ryder Street

A total of 37 collisions were reported at this intersection over the last five years, of which there were one approaching impact, 17 angle impacts, 13 rear-end impacts, three sideswipe impacts, one turning movement impact, and two single-vehicle/other impacts. Ten of the 37 collisions resulted in injuries, but none caused fatalities. Thirteen of the collisions occurred in poor driving conditions. Two collisions involved cyclists, and no collisions involved pedestrians.

Of the 17 angle impacts, two involved a northbound vehicle and a westbound cyclist, and 15 involved a southbound vehicle and a westbound vehicle. Four of the 17 collisions occurred in poor driving conditions. The 15 southbound-westbound angle impacts meet the threshold to be considered a collision pattern. The apparent driver action in 14 of the 15 impacts was the westbound driver disobeying the traffic control. While the intersection appears to have standard geometry and no appreciable changes in grade, it is possible that driver sightlines are obscured at the northeast corner of the intersection, where there is currently fencing and tall vegetation. It should be noted that daylight triangles are not provided at the northwest or northeast corners of the intersection.

Of the 13 rear-end impacts, one involved southbound vehicles, five involved eastbound vehicles, and seven involved westbound vehicles. Three of the 13 collisions occurred in poor driving conditions. The seven westbound rear-end impacts meet the collision pattern threshold. It is anticipated that the number of rear-end impacts at this intersection is a function of high volumes on Walkley Road.

The two collisions involving cyclists included a northbound right-turning vehicle and a westbound through cyclist, suggesting that these cyclists were riding on the south sidewalk of Walkley Road.

Walkley Road/160m West of Conroy Road

A total of 11 collisions were reported at this intersection over the last five years, of which there were five rear-end impacts, four turning movement impacts, and two single vehicle/other impacts. Seven of the 11 collisions resulted in injuries, but none caused fatalities. Three of the collisions occurred in poor driving conditions. No collisions involved cyclists or pedestrians.

Walkley Road/Conroy Road

A total of 74 collisions were reported at this intersection over the last five years, of which there were four angle impacts, 51 rear-end impacts, 11 sideswipe impacts, four turning movement impacts, and four single vehicle/other impacts. Eight of the 74 collisions resulted in injuries, but none caused fatalities. Twenty-nine of the collisions occurred in poor driving conditions. One collision involved a pedestrian, and no collisions involved cyclists.

Of the 51 rear-end impacts, 16 involved northbound vehicles, 20 involved eastbound vehicles, and 15 involved westbound vehicles. Fifteen of the 51 collisions occurred in poor driving conditions. Each approach of this intersection meets the collision pattern threshold. It is anticipated that the number of rear-end impacts at this intersection is a function of the high traffic volumes observed on both Walkley Road and Conroy Road.

Of the 11 sideswipe impacts, three involved northbound vehicles, two involved eastbound vehicles, and six involved westbound vehicles. Three of the 11 collisions occurred in poor driving conditions.

The collision involving a pedestrian occurred in dark driving conditions, and involved a westbound through vehicle. The collision records identify that the vehicle was being driven properly, suggesting that the pedestrian may not have crossed during the appropriate 'walk' phase.

St. Laurent Boulevard/Conroy Road

A total of 22 collisions were reported at this intersection over the last five years, of which there were seven angle impacts, ten rear-end impacts, three sideswipe impacts, and two single vehicle/other impacts. Five of the 22 collisions resulted in injuries, but none caused fatalities. Seven of the collisions occurred in poor driving conditions. No collisions involved cyclists or pedestrians.

Of the seven angle impacts, five involved a northbound vehicle and a westbound vehicle, and two involved a southbound vehicle and a westbound vehicle. Three of the seven collisions occurred in poor driving conditions.

Of the ten rear-end impacts, two involved northbound vehicles, three involved southbound vehicles, three involved eastbound vehicles, and two involved westbound vehicles. One of the ten collisions occurred in poor driving conditions.

St. Laurent Boulevard/Don Reid Drive

One collision has been reported at this intersection over the last five years, which was an angle impact in poor driving conditions. This collision did not result in injuries, and did not involve cyclists or pedestrians.

Walkley Road between Don Reid Drive and 160m West of Conroy Road

A total of five collisions were reported along this segment over the last five years, of which there were four rear-end impacts and one sideswipe impact. All impacts involved eastbound vehicles. Three of the five collisions occurred in poor driving conditions, and no collisions resulted in injuries. No collisions involved cyclists or pedestrians.

Walkley Road between Conroy Road and 160m West of Conroy Road

A total of seven collisions were reported along this segment over the last five years, of which there were two angle impacts, four rear-end impacts, and one turning movement impact. Four of the seven collisions occurred in poor driving conditions, and no collisions resulted in injuries. No collisions involved cyclists or pedestrians.

Conroy Road between Walkley Road and St. Laurent Boulevard

A total of three collisions were reported along this segment over the last five years, of which there was one rear-end impact, one sideswipe impact, and one single vehicle/other impact. Two of the three collisions occurred in poor driving conditions, and the single-vehicle impact resulted in injuries. No collisions involved cyclists or pedestrians.

St. Laurent Boulevard between Conroy Road and Don Reid Drive

A total of two collisions were reported along this segment over the last five years, of which there was one angle impact and one single vehicle/other impact. One of the two collisions occurred in poor driving conditions, and neither collision resulted in injuries. The collisions did not involve cyclists or pedestrians.

2.2 Planned Conditions

2.2.1 Planned Transportation Projects

The 2013 Ottawa Cycling Plan and 2013 Ottawa Pedestrian Plan do not identify any improvements within the study area.

The City's 2013 Transportation Master Plan (TMP) identifies a Rapid Transit and Transit Priority (RTTP) project within the study area. The Baseline/Heron/Walkley/St. Laurent Bus Rapid Transit (BRT) project will provide high-quality transit access to employment, commercial, and institutional land uses along the corridor. In the 2031 Affordable Network, at-grade BRT is planned to run from Baseline Station to Heron Station (i.e. west of the study area). In the 2031 Network Concept, at-grade BRT will connect from Bayshore Station to St. Laurent Station. The 2031 Network Concept will not be implemented prior to 2031.

Conroy Road is identified in the City's TMP for transit signal priority and queue jump lanes between Walkley Road and Hunt Club Road. This corridor is part of the City's 2031 RTTP Network Concept, but will not be implemented prior to 2031.

The Alta Vista Transportation Corridor is identified in the 2031 Roadway Network Concept, as a new four-lane roadway (including two peak-period bus lanes) between the Ottawa Health Services Centre and Walkley Road at Conroy Road. The roadway will also include transit signal priority and queue jump lanes, and will improve transit access to the Ottawa Hospital, CHEO, and the Canadian Forces Health Care Centre. The roadway is anticipated to address capacity deficiencies and the Environmental Assessment (EA) is complete. While this corridor is part of the City's 2031 Network Concept, it will not be implemented prior to 2031.

2.2.2 Other Area Developments

In proximity of the subject site, there are multiple other developments that are under construction, approved, or in the approval process. In the list below, only development applications significant enough to necessitate transportation studies are included.

Timbercreek Heron Gate

The proposed redevelopment is located at 2848, 2851, 2881, and 2898 Baycrest Drive, and 2820 and 2831 Cedarwood Drive. In seven blocks, the redevelopment will consist of 118 low-rise dwellings, 2,047 mid-rise dwellings, and 2,874 high-rise dwellings. A TIA was prepared in April 2021 by CGH, in support of Zoning By-Law Amendment and Official Plan Amendment applications, and notes that subsequent TIAs will be required as Site Plan Control applications for each block as the project moves forward. Per the 2021 TIA, the anticipated buildout year for this development is 2040, and therefore analysis was conducted for an interim year 2030 and ultimate buildout year 2040.

2020 Walkley Road and 2935 Conroy Road

The proposed redevelopment will consist of three single-storey warehouses with a total gross floor area (GFA) of approximately 262,715 ft². A TIA was prepared in August 2021 by Novatech, in support of Zoning By-Law Amendment and Site Plan Control applications. Per the 2021 TIA, the anticipated buildout year of the development is 2023, and analysis was conducted for the buildout year 2023 and horizon year 2028.

2500 St. Laurent Boulevard

The now-constructed development consists of two two-storey office buildings with a total GFA of approximately 68,134 ft². A Transportation Brief was prepared in October 2017 by Stantec. Per the brief, the anticipated buildout year was 2021 (i.e. after traffic count data was collected at all signalized study area intersections), and analysis was conducted for the buildout year 2021 and horizon year 2026.

2190 Halifax Drive

The proposed development will consist of 202 additional high-rise dwellings. A TIA was prepared in July 2019 by Dillon, in support of a Site Plan Control application. Per the 2019 TIA, the anticipated buildout year was 2021, and analysis was conducted for the buildout year 2021 and horizon year 2026. For the purposes of this TIA, buildout of this development is anticipated to occur by 2024 (i.e. the assumed buildout year for this application).

2.3 Study Area and Time Periods

The study area for this report includes the boundary roadways Walkley Road, Conroy Road, St. Laurent Boulevard, and Don Reid Drive, as well as the following intersections:

- Walkley Road/Don Reid Drive/Ryder Street
- Walkley Road/160m West of Conroy Road
- Walkley Road/Conroy Road
- St. Laurent Boulevard/Conroy Road
- St. Laurent Boulevard/Don Reid Drive

The selected time periods for the analysis are the weekday AM and PM peak hours, as they represent the ‘worst case’ combination of site generated traffic and adjacent street traffic. Analysis will be completed for the 2024 build-out year and 2029 horizon year.

2.4 Exemptions Review

This module reviews possible exemptions from the final Transportation Impact Assessment, as outlined in the 2017 TIA Guidelines. The applicable exemptions for this site are shown in **Table 4**.

Table 4: TIA Exemptions

Module	Element	Exemption Criteria	Status
Design Review Component			
4.1 Development Design	4.1.2 Circulation and Access	• Only required for site plans	Not Exempt
	4.1.3 New Street Networks	• Only required for plans of subdivision	Not Exempt
4.2 Parking	4.2.1 Parking Supply	• Only required for site plans	Not Exempt
	4.2.2 Spillover Parking	• Only required for site plans where parking supply is 15% below unconstrained demand	Exempt
Network Impact Component			
4.5 Transportation Demand Management	<i>All elements</i>	• Not required for non-residential site plans expected to have fewer than 60 employees and/or students on location at any given time	Not Exempt
4.6 Neighbourhood Traffic Management	4.6.1 Adjacent Neighbourhoods	• Only required when the development relies on local or collector streets for access and total volumes exceed ATM capacity thresholds	Not Exempt
4.8 Network Concept	<i>All elements</i>	• Only required when proposed development generates more than 200 person-trips during the peak hour in excess of the equivalent volume permitted by the established zoning	Exempt

Based on the foregoing, the following modules will be included in the TIA report:

Design Review Component

- Module 4.1: Development Design
- Module 4.2: Parking
- Module 4.3: Boundary Streets
- Module 4.4: Access Design

Network Impact Component

- Module 4.5: Transportation Demand Management
- Module 4.6: Neighbourhood Traffic Management
- Module 4.7: Transit
- Module 4.9: Intersection Design

3.0 FORECASTING

3.1 Development-Generated Travel Demand

3.1.1 Trip Generation

Trips generated by the proposed townhouse/apartment dwellings and proposed retirement dwellings have been estimated separately, as described below.

Proposed Townhouse/Apartment Dwellings

The number of person trips generated by the proposed townhouse and apartment dwellings have been estimated using the *TRANS Trip Generation Manual Summary Report*, which was prepared in October 2020 by WSP. The *TRANS Trip Generation Manual* presents peak period trip generation rates and mode shares for different types of housing for the AM and PM peak periods, including the Low-Rise (one to two storeys) and High-Rise (three or more storeys) Multifamily Housing land uses. The process of converting the trip generation estimates from peak period to peak hour is discussed below. Relevant excerpts of the *TRANS Trip Generation Manual* are included in **Appendix F**.

The *TRANS Trip Generation Manual* identifies the subject site as being located within the Alta Vista district, which has the following observed mode shares for low-rise and high-rise multifamily housing during the peak hours:

Mode	Low-Rise Multifamily Housing	High-Rise Multifamily Housing
• Auto Driver:	38% AM peak, 38% PM peak;	38% AM peak, 45% PM peak.
• Auto Passenger:	15% AM peak, 19% PM peak;	12% AM peak, 16% PM peak.
• Transit:	35% AM peak, 31% PM peak;	42% AM peak, 28% PM peak.
• Cyclist:	1% AM peak, 2% PM peak;	2% AM peak, 2% PM peak.
• Pedestrian:	10% AM peak, 10% PM peak;	7% AM peak, 9% PM peak.

One set of mode shares have been assumed for both peak hours and for both townhouse and apartment residents. These mode shares are generally based on the above mode shares (i.e. 40% driver, 15% passenger, 30% transit, 5% cyclist, 10% pedestrian).

For the Multifamily Housing land uses, the process of converting the trip generation estimates from peak period to peak hour is shown in the following tables. The estimated number of person trips generated by the proposed townhouse dwellings for the AM and PM peak periods are shown in **Table 5**. A breakdown of these trips by modal share is shown in **Table 6**.

Table 5: Proposed Townhouses and Apartments – Peak Period Trip Generation

Land Use	TRANS Rate	Units	AM Peak Period (ppp ⁽¹⁾)			PM Peak Period (ppp)		
			IN	OUT	TOT	IN	OUT	TOT
Low-Rise Multifamily Housing	AM: 1.35 PM: 1.58	160	65	151	216	141	111	252
High-Rise Multifamily Housing	AM: 0.80 PM: 0.90	100	25	55	80	52	38	90
Total			90	206	296	193	149	342

1. ppp: Person Trips per Peak Period

Table 6: Proposed Townhouses and Apartments – Peak Period Trips by Mode Share

Travel Mode	Mode Share	AM Peak Period			PM Peak Period		
		IN	OUT	TOT	IN	OUT	TOT
Peak Period Person Trips		90	206	296	193	149	342
Auto Driver	40%	36	82	118	77	59	136
Auto Passenger	15%	13	31	44	29	23	52
Transit	30%	27	62	89	58	44	102
Cyclist	5%	5	10	15	10	8	18
Pedestrian	10%	9	21	30	19	15	34

Table 4 of the *TRANS Trip Generation Manual* includes adjustment factors to convert the estimated number of trips generated for each mode from peak period to peak hour. A breakdown of the peak hour trips by mode is shown in **Table 7**.

Table 7: Proposed Townhouses and Apartments – Peak Hour Trips by Mode Share

Travel Mode	Adj. Factor		AM Peak Hour			PM Peak Hour		
	AM	PM	IN	OUT	TOT	IN	OUT	TOT
Auto Driver	0.48	0.44	17	40	57	34	26	60
Auto Passenger	0.48	0.44	6	15	21	13	10	23
Transit	0.55	0.47	15	34	49	27	21	48
Cyclist	0.58	0.48	3	6	9	5	4	9
Pedestrian	0.58	0.52	5	12	17	10	8	18
Peak Hour Person Trips			46	107	153	89	69	158

Proposed Retirement Dwellings

The number of person trips generated by the proposed retirement dwellings have been estimated using the trip generation rates outlined in the *ITE Trip Generation Manual, 11th Edition*, corresponding to the Congregate Care Facility land use (code 253). Trips estimated using the *ITE Trip Generation Manual* have been converted to person trips using an adjustment factor of 1.28, consistent with the City’s *2017 TIA Guidelines*.

Mode shares for the proposed retirement dwellings have been estimated using data outlined in the *2011 TRANS O-D Survey Report*, based on all trips from/within the Alta Vista district during the AM peak hour and all trips to/within Alta Vista during the PM peak hour.

The estimated number of person trips generated by the proposed retirement dwellings for the AM and PM peak hours are shown in **Table 8**. A breakdown of these trips by modal share is shown in **Table 9**.

Table 8: Proposed Retirement – Peak Hour Trip Generation

Land Use	ITE Code	Units	AM Peak Hour (pph ⁽¹⁾)			PM Peak Hour (pph)		
			IN	OUT	TOT	IN	OUT	TOT
Congregate Care	253	150	10	7	17	17	18	35

1. pph: Person Trips per Hour

Table 9: Proposed Retirement – Peak Hour Trips by Mode Share

Travel Mode	Mode Share	AM Peak Hour			PM Peak Hour		
		IN	OUT	TOT	IN	OUT	TOT
Peak Hour Person Trips		10	7	17	17	18	35
Auto Driver	55%	6	4	10	9	10	19
Auto Passenger	15%	1	1	2	3	3	6
Transit	20%	2	1	3	3	4	7
Cyclist	0%	-	-	-	-	-	-
Pedestrian	10%	1	1	2	2	1	3

The peak hour trip generation estimates by mode share for the entire proposed development (shown in **Table 7** and **Table 9**) have been added together, and are shown in **Table 10**.

Table 10: Entire Proposed Development – Total Peak Hour Trips

Travel Mode	AM Peak Hour			PM Peak Hour		
	IN	OUT	TOT	IN	OUT	TOT
Peak Hour Person Trips	56	114	170	106	87	193
Auto Driver	23	44	67	43	36	79
Auto Passenger	7	16	23	16	13	29
Transit	17	35	52	30	25	55
Cyclist	3	6	9	5	4	9
Pedestrian	6	13	19	12	9	21

As shown in the previous table, the proposed development is estimated to generate 170 person trips (including 67 vehicle trips) during the AM peak hour, and 193 person trips (including 79 vehicle trips) during the PM peak hour.

3.1.2 Trip Distribution

The assumed distribution of trips generated by the proposed development have been derived from existing traffic patterns associated with the typical commute (i.e. outbound AM trips and inbound PM trips), and can be summarized as follows:

- 15% to/from the south via Conroy Road;
- 10% to/from the east via St. Laurent Boulevard;
- 35% to/from the east via Walkley Road;
- 40% to/from the west via Walkley Road.

3.1.3 Trip Assignment

For the purposes of this TIA, all trips to/from the retirement home and apartment building have been assigned to a future RIRO access on Walkley Road or to Walkley Road/160m West of Conroy Road. Trips arriving from the west and departing to the south or east have been assigned equally between both access locations, while all other trips have been assigned to the intersection at Walkley Road/160m West of Conroy Road.

Based on the layout of the proposed development, vehicle trips generated by the proposed townhouses have been assigned to the proposed accesses as follows:

Eastern Access to St. Laurent Boulevard

- 60% of trips to/from the south via Conroy Road;
- 60% of trips to/from the east via St. Laurent Boulevard;
- 45% of trips to/from the east via Walkley Road;
- 5% of trips to/from the west via Walkley Road.

Western Access to St. Laurent Boulevard

- 30% of trips to/from the south via Conroy Road;
- 30% of trips to/from the east via St. Laurent Boulevard;
- 15% of trips to/from the east via Walkley Road;
- 5% of trips to/from the west via Walkley Road.

Access to Don Reid Drive

- 10% of trips to/from the south via Conroy Road;
- 10% of trips to/from the east via St. Laurent Boulevard;
- 40% of trips to/from the east via Walkley Road;
- 90% of trips to/from the west via Walkley Road.

3.2 Background Traffic

3.2.1 General Background Growth Rate

A review of snapshots of the City's *Strategic Long-Range Model* and *Intersection Traffic Growth Rates (2000-2016)* has been conducted. Both resources are included in **Appendix H**. Comparing snapshots of the 2011 and 2031 AM peak hour traffic volumes, the *Strategic Long-Range Model* generally suggests positive growth between 0% and 1% per annum on Walkley Road and negative growth between 0% and -1% per annum on Conroy Road. The *Intersection Traffic Growth Rates* figures, which determine growth rates based on total vehicular volumes entering the intersection, identify growth rates for the following study area intersections.

- Walkley Road/Conroy Road
 - AM Peak Hour: negative growth (between -0.2% and -2.0% per annum);
 - PM Peak Hour: negative growth (between -0.2% and -2.0% per annum).
- St. Laurent Boulevard/Conroy Road
 - AM Peak Hour: positive growth (between +0.2% and +2.0% per annum);
 - PM Peak Hour: no growth (between -0.2% and +0.2% per annum).

In the interest of maintaining a conservative analysis, an annual background growth rate assumption of 1% has been applied to the arterial roadways Walkley Road and Conroy Road in this TIA.

3.2.2 Other Area Developments

As first discussed in Section 2.2.2, traffic generated by the following developments in proximity of the subject site have been considered in the 2024 and 2029 background volumes. Relevant excerpts of the traffic studies in support of these developments are included in **Appendix G**.

Timbercreek Heron Gate

The proposed redevelopment is located at 2848, 2851, 2881, and 2898 Baycrest Drive, and 2820 and 2831 Cedarwood Drive. The redevelopment will ultimately consist of seven blocks, with 118 low-rise dwellings, 2,047 mid-rise dwellings, and 2,874 high-rise dwellings. Per the 2021 TIA, the anticipated buildout year for this development is 2040, and therefore analysis was conducted for an interim year 2030 and ultimate buildout year 2040. For the purposes of this TIA, traffic generated by the interim year 2030 has been added to the 2029 background traffic volumes.

2020 Walkley Road and 2935 Conroy Road

The proposed redevelopment will consist of three single-storey warehouses with a total gross floor area (GFA) of approximately 262,715 ft². Per the 2021 TIA, the anticipated buildout year of the development is 2023, and analysis was conducted for the buildout year 2023 and horizon year 2028. For the purposes of this TIA, traffic generated by this development has been added to the 2024 and 2029 background traffic volumes.

2500 St. Laurent Boulevard

The now-constructed development consists of two two-storey office buildings with a total GFA of approximately 68,134 ft². A Transportation Brief was prepared in October 2017 by Stantec. Since traffic count data was collected at all signalized study area intersections prior to completion of the development, site-generated traffic has been added to the 2024 and 2029 background traffic volumes within the study area.

2190 Halifax Drive

The proposed development will consist of 202 additional high-rise dwellings. Per the 2019 TIA, the anticipated buildout year was 2021, and analysis was conducted for the buildout year 2021 and horizon year 2026. For the purposes of this TIA, traffic generated by this development has been added to the 2024 and 2029 background traffic volumes.

3.3 Future Traffic Conditions

The figures below present the following future traffic conditions:

- Proposed site-generated traffic volumes are shown in **Figure 6**;
- Other area development-generated traffic volumes in 2024 are shown in **Figure 7**;
- Other area development-generated traffic volumes in 2029 are shown in **Figure 8**;
- Background traffic volumes in 2024 are shown in **Figure 9**;
- Background traffic volumes in 2029 are shown in **Figure 10**;
- Total traffic volumes in 2024 are shown in **Figure 11**;
- Total traffic volumes in 2029 are shown in **Figure 12**.

Figure 6: Site-Generated Traffic Volumes

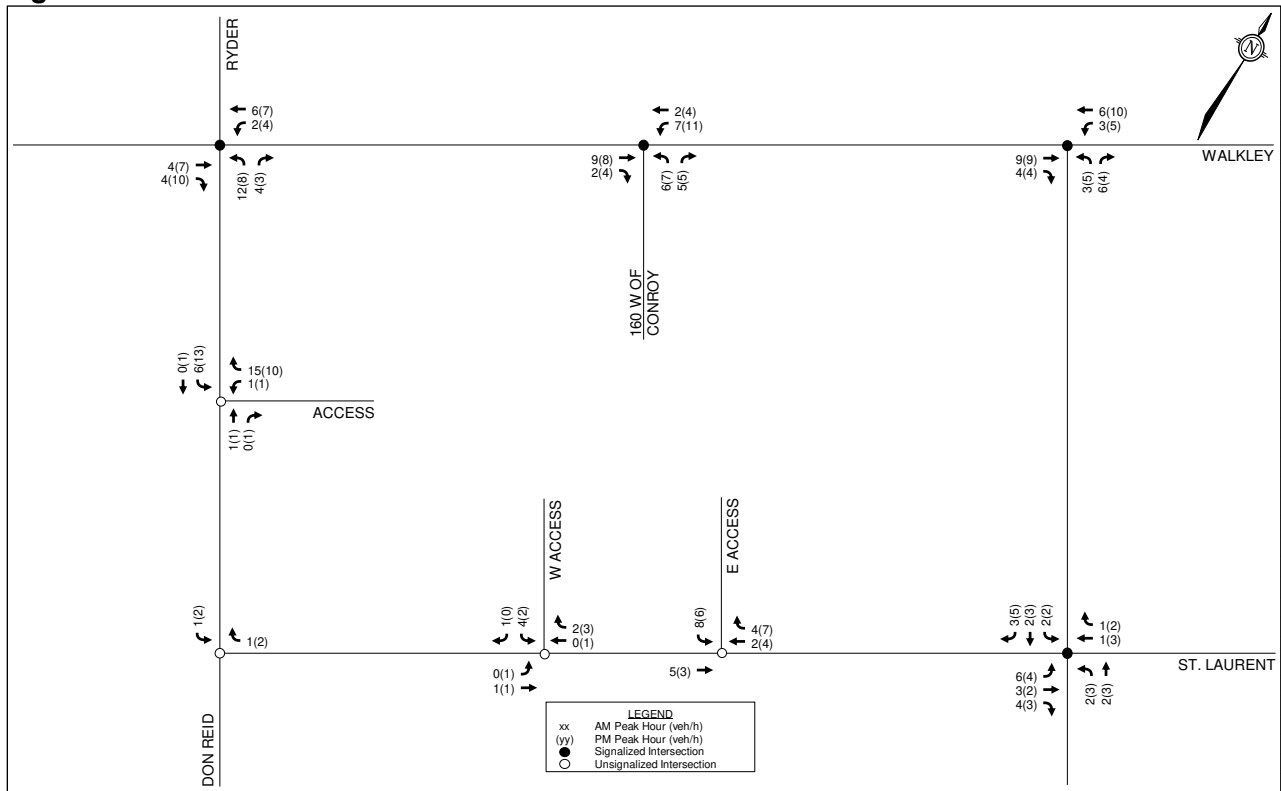

Figure 7: 2024 Other Area Development-Generated Traffic Volumes

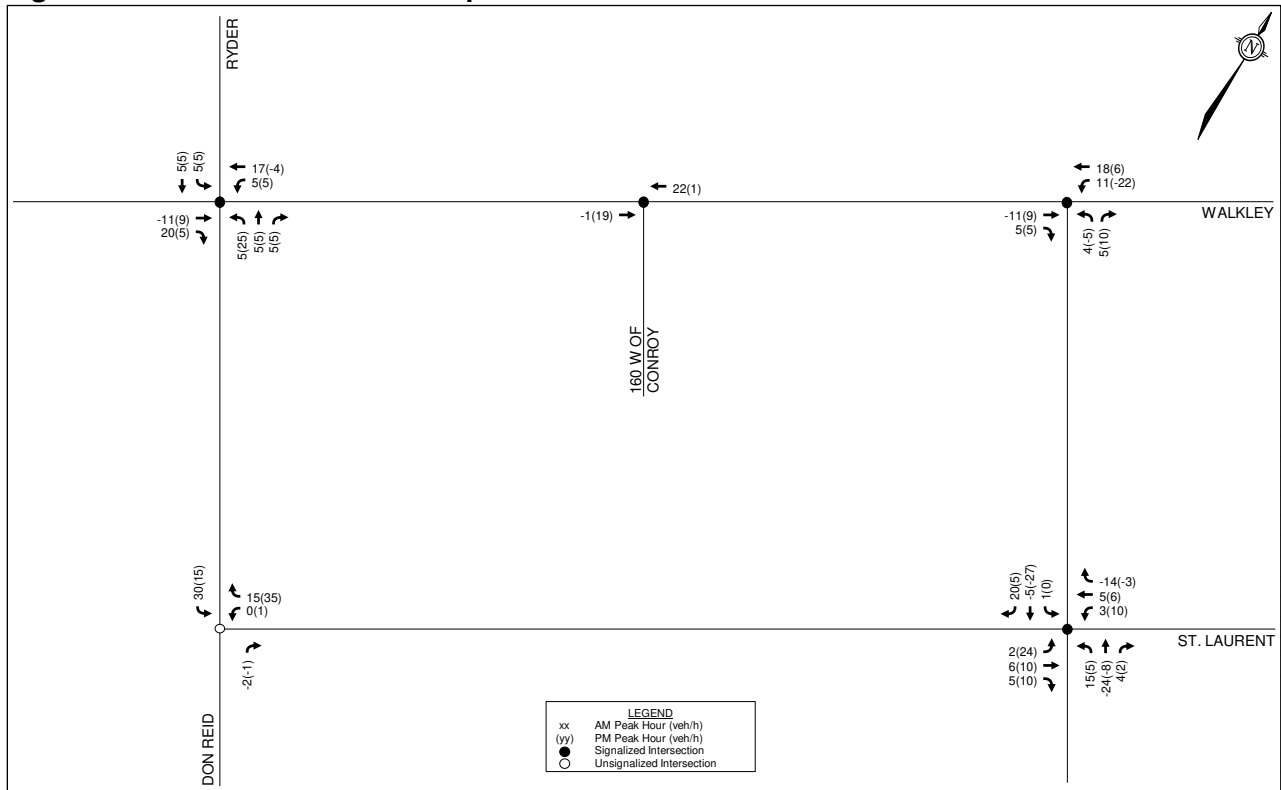

Figure 8: 2029 Other Area Development-Generated Traffic Volumes

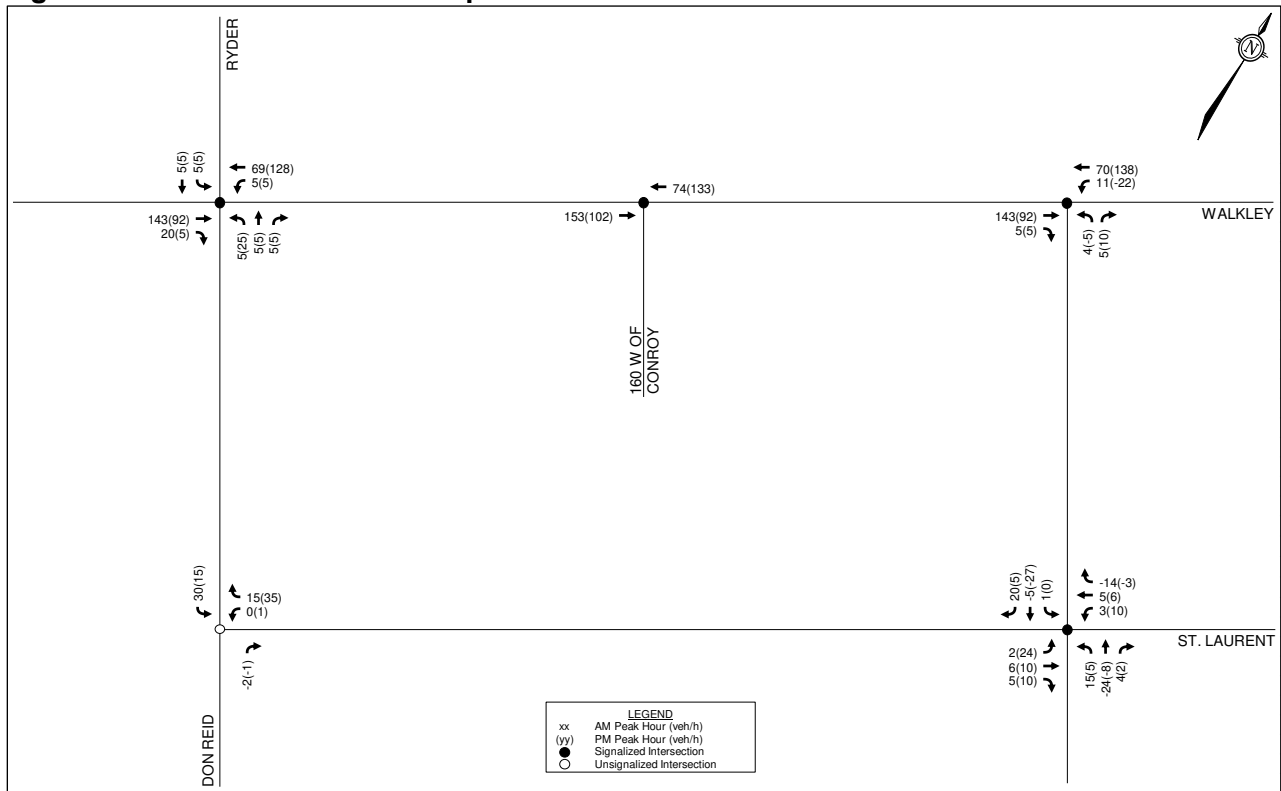

Figure 9: 2024 Background Traffic Volumes

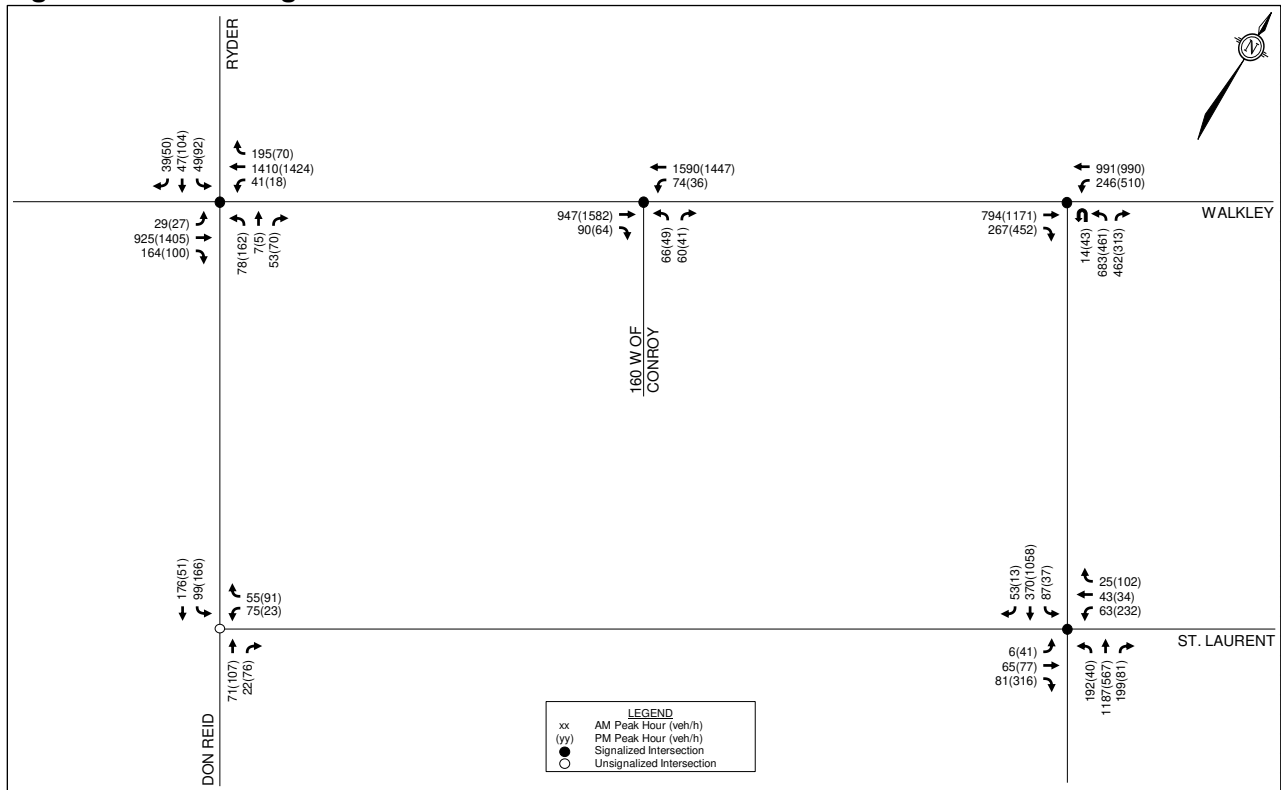

Figure 10: 2029 Background Traffic Volumes

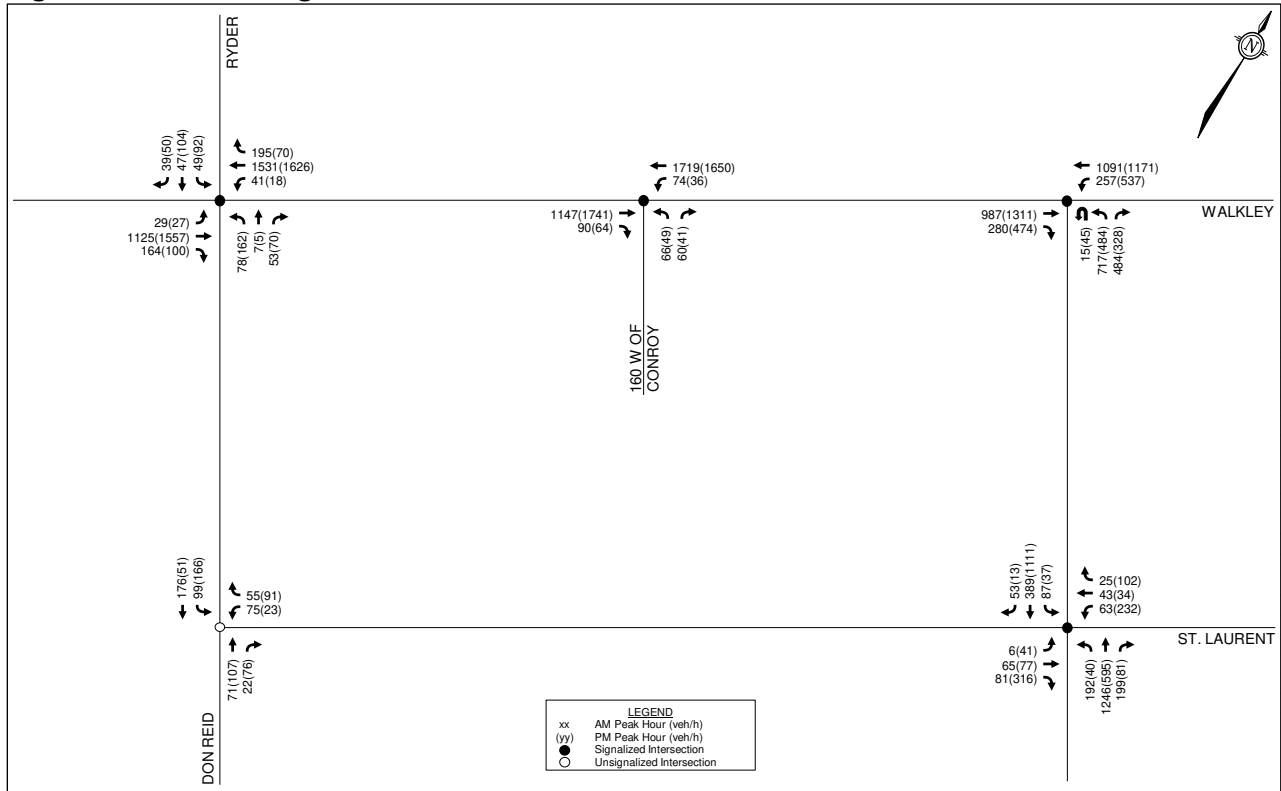

Figure 11: 2024 Total Traffic Volumes

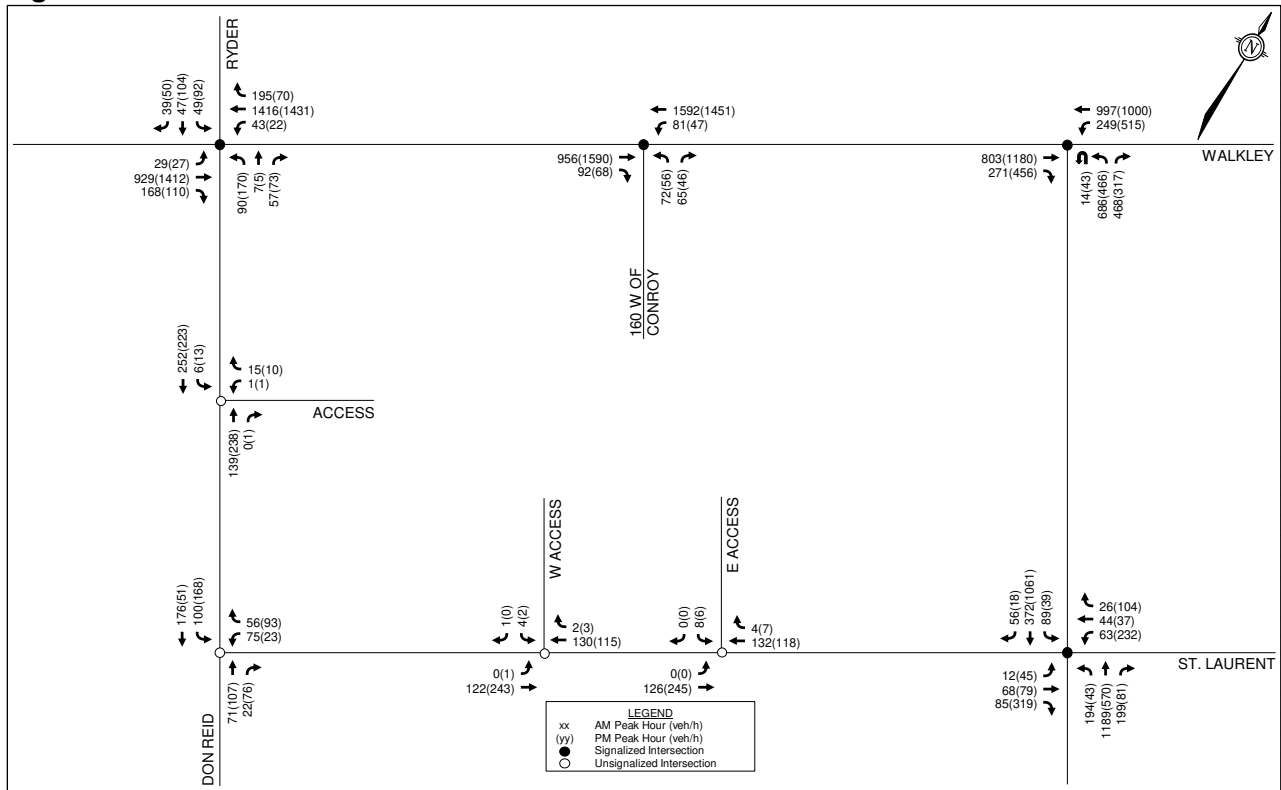
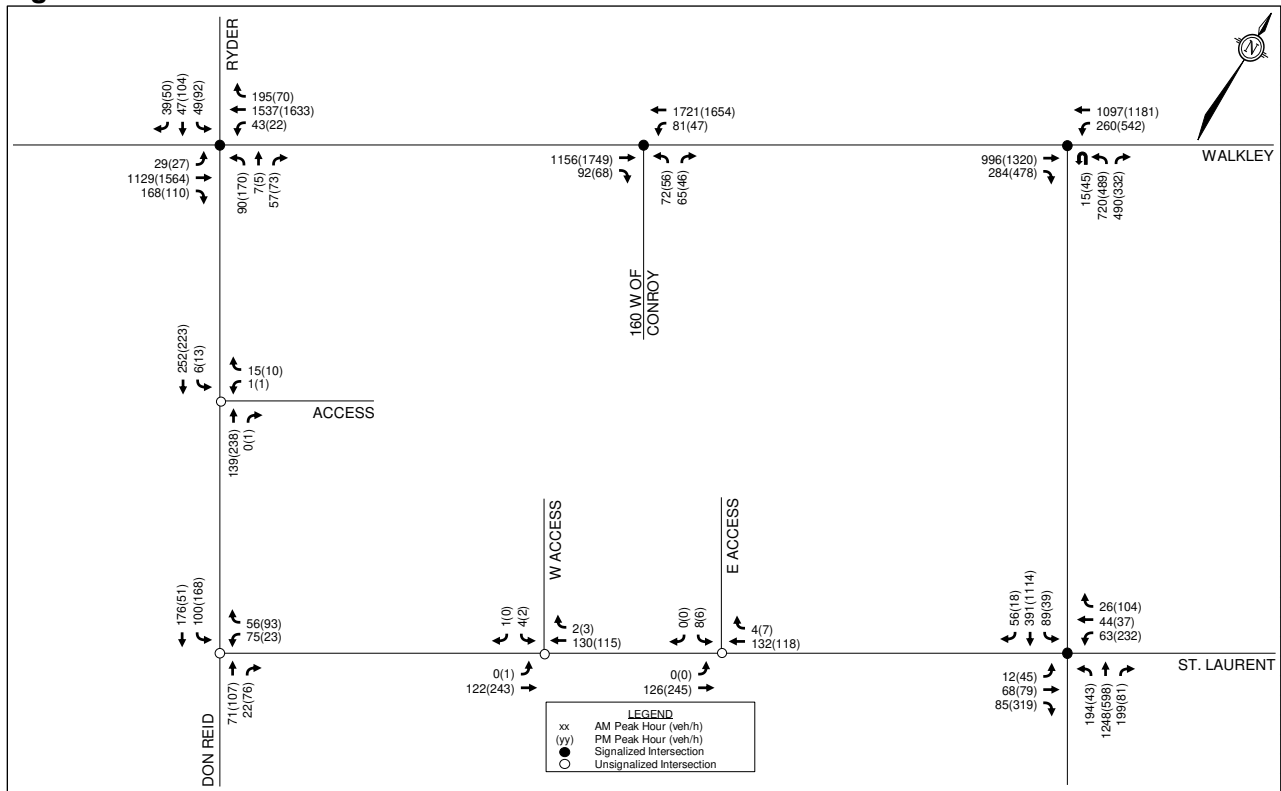

Figure 12: 2029 Total Traffic Volumes



3.4 Demand Rationalization

A review of the existing and background intersection operations has been conducted using Synchro 11, to determine if and when traffic volumes exceed capacity within the study area. The intersection parameters used in the analysis are consistent with the *2017 TIA Guidelines* (Saturated Flow Rate: 1,800 vphpl, Peak Hour Factor: 0.9 in existing conditions and 1.0 in future conditions).

Per Exhibit 22 of the *Multi-Modal Level of Service (MMLOS) Guidelines*, the target vehicular level of service (Auto LOS) at all study area intersections is an Auto LOS D, which equates to a vehicle-to-capacity (v/c) ratio of 0.90 at signalized intersections, and a maximum delay of 35 seconds at unsignalized intersections. Signal timing plans were obtained from the City, and are included in **Appendix I**.

3.4.1 Existing Intersection Operations

Intersection capacity analysis has been conducted for the existing traffic conditions. The results of the analysis are summarized in **Table 11** and **Table 12** for the weekday AM and PM peak hours. Detailed reports are included in **Appendix J**.

Table 11: Existing Traffic Operations

Intersection	Period	Critical Movements			Intersection		
		Max v/c or Delay	LOS	Mvmt	v/c	Delay	LOS
Walkley Road/ Don Reid Drive/Ryder Street ⁽¹⁾	AM	0.71	C	WBT/R	0.67	9 sec	B
	PM	0.81	D	NBL	0.70	16 sec	B
Walkley Road/ 160m West of Conroy Road ⁽¹⁾	AM	0.67	B	WBT	0.66	8 sec	B
	PM	0.64	B	EBT	0.63	6 sec	B
Walkley Road/ Conroy Road ⁽¹⁾	AM	0.88	D	NBL	0.73	29 sec	C
	PM	0.94 0.91	E E	EBT WBL	0.91	31 sec	E
St. Laurent Boulevard/ Conroy Road ⁽¹⁾	AM	0.57	A	SBL	0.46	13 sec	A
	PM	0.79	C	EBR	0.73	25 sec	C
St. Laurent Boulevard/ Don Reid Drive ⁽²⁾	AM	12 sec	B	WBL	-		
	PM	11 sec	B	WBL			

- 1. Signalized intersection
- 2. Unsignalized intersection

Table 12: Existing Queues

Intersection	Mvmt	Storage/ Spacing ⁽¹⁾	AM Peak			PM Peak		
			v/c [LOS]	50 th % Queue (m)	95 th % Queue (m)	v/c [LOS]	50 th % Queue (m)	95 th % Queue (m)
Walkley Rd/Don Reid Dr/Ryder St	NBL	35m	0.46 [A]	14	22	0.81 [D]	29	46
	WBT/R	140m	0.71 [C]	29	#193	0.71 [C]	58	51
Walkley Rd/160m West of Conroy Rd	WBT	130m	0.67 [B]	60	140	0.58 [A]	72	130
Walkley Rd/ Conroy Rd	EBT	130m	0.62 [B]	77	102	0.94 [E]	89	#169
	WBL	200m	0.66 [B]	28	39	0.91 [E]	58	#87

- 1. Indicates the storage length for auxiliary lanes or the spacing to the nearest upstream intersection for through lanes
- #: volume for the 95th percentile cycle exceeds capacity

From the previous tables, the eastbound through and westbound left turn movements at Walkley Road/Conroy Road operate at an Auto LOS E during the PM peak hour. An alternate scenario where the cycle length is increased from 110 seconds to 120 seconds (with all additional green time allocated to the eastbound-westbound phases) has been reviewed, and indicate that this mitigation allows both movements to operate at the target Auto LOS D. Detailed reports of this alternate scenario are included in **Appendix J**.

During the AM peak hour, the Synchro analysis identifies that the maximum (95th-percentile) queue lengths of the westbound through movements at Walkley Road/Don Reid Drive/Ryder Street and Walkley Road/160m West of Conroy Road extend into the upstream intersections on Walkley Road.

During the PM peak hour, the Synchro analysis identified that the maximum queue length of the northbound left turn movement at Walkley Road/Don Reid Drive/Ryder Street exceeds the storage length of the auxiliary northbound left turn, but is contained within the taper. The maximum queue length of the eastbound through movement at Walkley Road/Conroy Road extends into the upstream intersection on Walkley Road.

3.4.2 2024 Background Intersection Operations

Intersection capacity analysis has been conducted for the 2024 background traffic conditions. The results of the analysis are summarized in **Table 13** and **Table 14** for the weekday AM and PM peak hours. Detailed reports are included in **Appendix K**.

Table 13: 2024 Background Traffic Operations

Intersection	Period	Critical Movements			Intersection		
		Max v/c or Delay	LOS	Mvmt	v/c	Delay	LOS
Walkley Road/ Don Reid Drive/Ryder Street ⁽¹⁾	AM	0.66	B	WBT/R	0.63	8 sec	B
	PM	0.81	D	NBL	0.65	16 sec	B
Walkley Road/ 160m West of Conroy Road ⁽¹⁾	AM	0.63	B	WBT	0.61	7 sec	B
	PM	0.60	A	EBT	0.58	5 sec	A
Walkley Road/ Conroy Road ⁽¹⁾	AM	0.84	D	NBL	0.68	27 sec	B
	PM	0.84	D	WBL	0.82	27 sec	D
St. Laurent Boulevard/ Conroy Road ⁽¹⁾	AM	0.43	A	SBL	0.41	12 sec	A
	PM	0.76	C	EBR	0.66	22 sec	B
St. Laurent Boulevard/ Don Reid Drive ⁽²⁾	AM	12 sec	B	WBL	-		
	PM	11 sec	B	WBL			

- 1. Signalized intersection
- 2. Unsignalized intersection

Table 14: 2024 Background Queues

Intersection	Mvmt	Storage/ Spacing ⁽¹⁾	AM Peak			PM Peak		
			v/c [LOS]	50 th % Queue (m)	95 th % Queue (m)	v/c [LOS]	50 th % Queue (m)	95 th % Queue (m)
Walkley Rd/Don Reid Dr/Ryder St	NBL	35m	0.44 [A]	13	21	0.81 [D]	31	49
	WBT/R	140m	0.66 [B]	27	30	0.65 [B]	55	51
Walkley Rd/160m West of Conroy Rd	WBT	130m	0.63 [B]	52	120	0.53 [A]	60	111
Walkley Rd/Conroy Rd	EBT	130m	0.55 [A]	66	90	0.83 [D]	67	#134
	WBL	200m	0.65 [B]	27	37	0.84 [D]	49	#71

- 1. Indicates the storage length for auxiliary lanes or the spacing to the nearest upstream intersection for through lanes
- #: volume for the 95th percentile cycle exceeds capacity

From the previous tables, all intersections operate at the target Auto LOS D or better. Compared to the existing conditions, improvements in some movements is due to differences in the Peak Hour Factor parameter (0.9 in existing conditions and 1.0 in future conditions, per the *2017 TIA Guidelines*).

3.4.3 2029 Background Intersection Operations

Intersection capacity analysis has been conducted for the 2029 background traffic conditions. The results of the analysis are summarized in **Table 15** and **Table 16** for the weekday AM and PM peak hours. Detailed reports are included in **Appendix K**.

Table 15: 2029 Background Traffic Operations

Intersection	Period	Critical Movements			Intersection		
		Max v/c or Delay	LOS	Mvmt	v/c	Delay	LOS
Walkley Road/ Don Reid Drive/Ryder Street ⁽¹⁾	AM	0.70	B	WBT/R	0.66	9 sec	B
	PM	0.81	D	NBL	0.72	16 sec	C
Walkley Road/ 160m West of Conroy Road ⁽¹⁾	AM	0.68	B	WBT	0.66	7 sec	B
	PM	0.66	B	EBT	0.64	6 sec	B
Walkley Road/ Conroy Road ⁽¹⁾	AM	0.87	D	NBL	0.75	29 sec	C
	PM	0.95	E	EBT	0.90	30 sec	D
St. Laurent Boulevard/ Conroy Road ⁽¹⁾	AM	0.46	A	SBL	0.43	12 sec	A
	PM	0.76	C	EBR	0.68	23 sec	B
St. Laurent Boulevard/ Don Reid Drive ⁽²⁾	AM	12 sec	B	WBL	-		
	PM	11 sec	B	WBL			

- 1. Signalized intersection
- 2. Unsignalized intersection

Table 16: 2029 Background Queues

Intersection	Mvmt	Storage/ Spacing ⁽¹⁾	AM Peak			PM Peak		
			v/c [LOS]	50 th % Queue (m)	95 th % Queue (m)	v/c [LOS]	50 th % Queue (m)	95 th % Queue (m)
Walkley Rd/Don Reid Dr/Ryder St	NBL	35m	0.44 [A]	13	21	0.81 [D]	31	48
	WBT/R	140m	0.70 [B]	28	#191	0.74 [C]	57	50
Walkley Rd/160m West of Conroy Rd	WBT	130m	0.68 [B]	61	142	0.61 [B]	77	141
Walkley Rd/ Conroy Rd	EBT	130m	0.69 [B]	91	120	0.95 [E]	~104	#179
	WBL	200m	0.67 [B]	28	39	0.87 [D]	53	#77

- 1. Indicates the storage length for auxiliary lanes or the spacing to the nearest upstream intersection for through lanes
- #: volume for the 95th percentile cycle exceeds capacity
- ~: approach is above capacity

From the previous tables, the eastbound through movement at Walkley Road/Conroy Road operates at an Auto LOS E during the PM peak hour. The alternate timing discussed in Section 3.4.1 (increasing the green time for the eastbound-westbound phases) has been reviewed, and the analysis indicates that this mitigation allows the eastbound through movement to operate at the target Auto LOS D. Detailed reports of this alternate scenario are included in **Appendix K**.

4.0 ANALYSIS

4.1 Development Design

Further review of the proposed retirement and apartment block will be conducted in a future Site Plan Control application. The Development Design, Parking, Access Intersections, and Transportation Demand Management modules below have only been conducted for the proposed townhouses. The preliminary site plan is included in **Appendix A**.

4.1.1 Design for Sustainable Modes

In general, the proposed development includes a pavement width of 6.5m to 6.7m for on-site roadways with perpendicular parking spaces or no on-street parking. Parallel parking spaces are provided on the south side of Street 1 (adjacent to the public park), the east side of Street 1 (adjacent to 2500 St. Laurent Boulevard), and on the north side of Street 3 (adjacent to the commercial access serving 1950 Walkley Road and 2980 Conroy Road). These parallel parking spaces are provided in the form of lay-bys, to maintain a narrower pavement width outside of these spaces and reduce the operating speed of vehicles on-site.

On-site concrete sidewalks with a width of 1.8m will be provided in the following locations:

- Along the south side of Street 1 between Don Reid Drive and Street 3 (providing a direct connection to the public park),
- Along the east side of Street 1 (providing a direct and generally straight connection through the site from St. Laurent Boulevard to the additional owned lands to the north),
- Along the south side of Street 3 (providing a direct and straight connection from Street 1 to Conroy Road), and
- Along the east side of the additional lands to the north (providing a direct and straight connection from Street 1 to Walkley Road).

Midblock pathways with a width of 2.0m will also be provided between the proposed public park and Street 2, and between Street 2 and Street 1 at Street 3. These sidewalks and pathways will connect the development to Conroy Road, St. Laurent Boulevard, Don Reid Drive, and the proposed parkland fronting Don Reid Drive. It is anticipated that the sidewalk will be extended along the eastern frontage of the future development and connect to Walkley Road as part of a future Site Plan Control application.

The nearest bus stops are discussed in Section 2.1.5. OC Transpo's service design guidelines for peak period service is to provide service within a five-minute (400m) walk of home, work, or school, for 95% of urban residents. Residents or visitors of any proposed dwelling will be within 400m of at least one bus stop shown in **Figure 4**.

A review of the City's *Transportation Demand Management (TDM)-Supportive Development Design and Infrastructure Checklist* has been conducted. Any required TDM-supportive design and infrastructure measures in the TDM checklist that are relevant to townhouse developments have been met. A copy of this checklist is included in **Appendix L**. In addition to the required measures, the proposed development also meets the following 'basic' or 'better' measures as defined in the *TDM-Supportive Development Design and Infrastructure Checklist*:

- Locate buildings close to the street, and do not locate parking areas between the street and building entrances;
- Locate building entrances in order to minimize walking distances to sidewalks and transit stops/stations;
- Locate building doors and windows to ensure visibility of pedestrians from the building, for their security and comfort;
- Provide safe, direct, and attractive walking routes from building entrances to nearby transit stops;
- Design roads used for access or circulation by cyclists using a target operating speed of no more than 30 km/h;

- Provide bicycle parking spaces equivalent to the expected number of resident-owned bicycles, plus the expected peak number of visitor cyclists.

4.1.2 Circulation and Access

Garbage collection will take place curbside in front of the proposed dwellings. The on-site fire route will include all private roadways within the subject site.

4.2 Parking

The subject site is located in Area C of Schedule 1 and Schedule 1A of the City’s ZBL. Minimum vehicle parking rates for the proposed townhouses are identified in Sections 101 and 102 of the ZBL, and are summarized in **Table 17**.

Table 17: Required and Proposed Parking

Land Use	Rate	Units	Required	Provided
<i>Minimum Vehicle Parking (Townhouse Dwellings)</i>				
Dwelling, Townhouse	1.0 per dwelling unit (residents)	160 units	160	320
	0.2 per dwelling unit (visitors)		32	
Additional parking on private streets				45
Total			192	365

Based on the previous table, the minimum parking requirements will be met. As every proposed dwelling will include their own garage, the ZBL does not identify any minimum bicycle parking requirements. A review of the parking requirements for the future development block will be conducted as part of a future Site Plan Control application.

4.3 Boundary Streets

This section provides a review of the boundary streets Walkley Road, Conroy Road, St. Laurent Boulevard, and Don Reid Drive, using complete streets principles. The *Multi-Modal Level of Service (MMLOS) Guidelines*, produced by IBI Group in October 2015, were used to evaluate the levels of service for each alternative mode of transportation on the boundary streets, based on existing conditions. Since each boundary street is located within both the General Urban Area and Urban Employment Area (per Schedule B of the City’s previous Official Plan, which is referenced by the *MMLOS Guidelines*), whichever target is more stringent has been considered.

A detailed segment MMLOS review of the boundary streets is included in **Appendix M**. A summary of the segment MMLOS analysis is provided below in **Table 18**.

Table 18: Segment MMLOS Summary

Segment	PLOS		BLOS		TLOS		TkLOS	
	Actual	Target	Actual	Target	Actual	Target	Actual	Target
Walkley Road	E	C	F	B	D	B	A	B
Conroy Road	E	C	E	B	D	D	A	B
St. Laurent Boulevard	F	C	F	B	-	-	B	D
Don Reid Drive	F	C	F	B	-	-	B	D

The results of the segment MMLOS analysis can be summarized as follows:

- No boundary street meets the target pedestrian level of service (PLOS);
- No boundary street meets the target bicycle level of service (BLOS);
- Conroy Road meets the target transit level of service (TLOS), while Walkley Road does not;
- All boundary streets meet the target truck level of service (TkLOS).

Pedestrian Level of Service

Both sides of Walkley Road and Conroy Road do not meet the target PLOS C. Per Exhibit 4 of the *MMLOS Guidelines*, Walkley Road can achieve the target PLOS C and Conroy Road can achieve a PLOS D by implementing sidewalks with a minimum width of 2.0m and a minimum boulevard width of 2.0m. This is identified for the City's consideration.

The south side of St. Laurent Boulevard and west side of Don Reid Drive do not meet the target PLOS C, as sidewalks are only provided on one side of each roadway. Per Exhibit 4 of the *MMLOS Guidelines*, implementing curbside sidewalks with a minimum width of 1.8m are sufficient to achieve the target PLOS. This is identified for the City's consideration. The existing sidewalks on St. Laurent Boulevard and Don Reid Drive meet the target PLOS C, and therefore no recommendations for these sidewalks are identified. Any sidewalks that need to be reconstructed as a result of the proposed development will be reinstated to a width of 1.8m.

Bicycle Level of Service

Walkley Road does not meet the target BLOS B. Per Exhibit 9 of the *MMLOS Guidelines*, the target BLOS B can only be achieved through the implementation of physically separated bikeways along Walkley Road. This is identified for the City's consideration.

A mixed-use pathway is provided on the west side of Conroy Road, which achieves the best-possible BLOS A. For the purposes of this review, the existing curbside bike lanes on both sides of Conroy Road have also been evaluated, and these bike lanes achieve a BLOS E.

St. Laurent Boulevard and Don Reid Drive do not meet the target BLOS B. Per Exhibit 9 of the *MMLOS Guidelines*, the target BLOS B can be achieved by providing curbside bike lanes with a minimum width of 1.5m, and reducing the operating speed to 50 km/h (i.e. a posted speed limit of 40 km/h).

Transit Level of Service

Walkley Road does not meet the target TLOS B, which is achieved by providing bus lanes with no or limited parking/driveway friction. It is anticipated that this target will be met upon completion of the Baseline/Heron/Walkley/St. Laurent BRT project, which is anticipated to occur beyond 2031.

4.4 Access Intersections

4.4.1 Access Design

The proposed development includes two full-movement accesses to St. Laurent Boulevard and one full-movement access to Don Reid Drive. Depressed curbs and continuous sidewalks are proposed along the entirety of each access, in accordance with City standards. The design of each access has been evaluated using the relevant provisions of the City's *Private Approach By-Law* (PABL).

Section 25(a) of the PABL identifies that, for sites with 46m or more of frontage to a given roadway, two two-way private approaches to that roadway are permitted. Therefore, the two-way private approaches to St. Laurent Boulevard and Don Reid Drive meet this requirement.

Section 25(c) of the PABL identifies a maximum width requirement of 9.0m for any two-way private approach, as measured at the street line. Since each private approach is approximately 7.2m to 7.7m in width at the street line, this requirement is met.

Section 25(g) of the PABL identifies a minimum separation requirement of 9.0m between a two-way private approach and any other private approach to the same property, measuring nearest edge to nearest edge at the street line. Since the proposed accesses to St. Laurent Boulevard are approximately 55m apart, this requirement is met.

Section 25(m)(ii) of the PABL identifies that, for a property that abuts or is within 46m of an arterial roadway, there are minimum distance requirements between a private approach and the nearest intersecting street line, and between any two private approaches to the same property. The minimum distance is determined by the land use and number of parking spaces provided. For the purposes of this review, the proposed residences will be treated as apartment dwellings, as the section does not directly reference requirements for townhouse developments. Per Section 25(m)(ii) of the PABL, the minimum separation between accesses to the same property is 30m, when 100 to 199 parking spaces are accessed. Although the proposed development will include more than 200 parking spaces, this range of parking spaces was selected as the parking spaces are distributed throughout the entire subject site. The 30m requirement is met, as a distance of approximately 55m is proposed between the nearest edges of the accesses to St. Laurent Boulevard.

Section 25(p) of the PABL identifies a minimum separation requirement of 3.0m between the edge of any private approach and the nearest property line, as measured at the street line. This requirement is met by all proposed accesses.

Section 25(u) of the PABL identifies a requirement that any private approach serving a parking area with more than 50 parking spaces shall not have a grade exceeding 2% for the first 9m inside the property line. This requirement is met by all proposed accesses.

The Transportation Association of Canada (TAC)'s *Geometric Design Guide for Canadian Roads* identifies minimum intersection sight distance (ISD) and stopping sight distance (SSD) requirements, based on the roadway grade and design speed (taken as the speed limit plus 10 km/h). Assuming level grade and a design speed of 60 km/h for St. Laurent Boulevard and Don Reid Drive, the ISD requirements are 130m for left-turning vehicles and 110m for right-turning vehicles, and the SSD requirement is 85m.

The proposed accesses to Don Reid Drive will have clear sightlines to Walkley Road to the north and St. Laurent Boulevard to the south. The proposed accesses to St. Laurent Boulevard are located on the inside of a slight curve, but will still achieve the TAC-recommended sightlines, provided that any vegetation within the ROW of St. Laurent Boulevard is trimmed and maintained. Therefore, no sightline concerns are anticipated. Intersection sight triangles for outbound drivers at each access are shown in **Figure 13** through **Figure 15**.

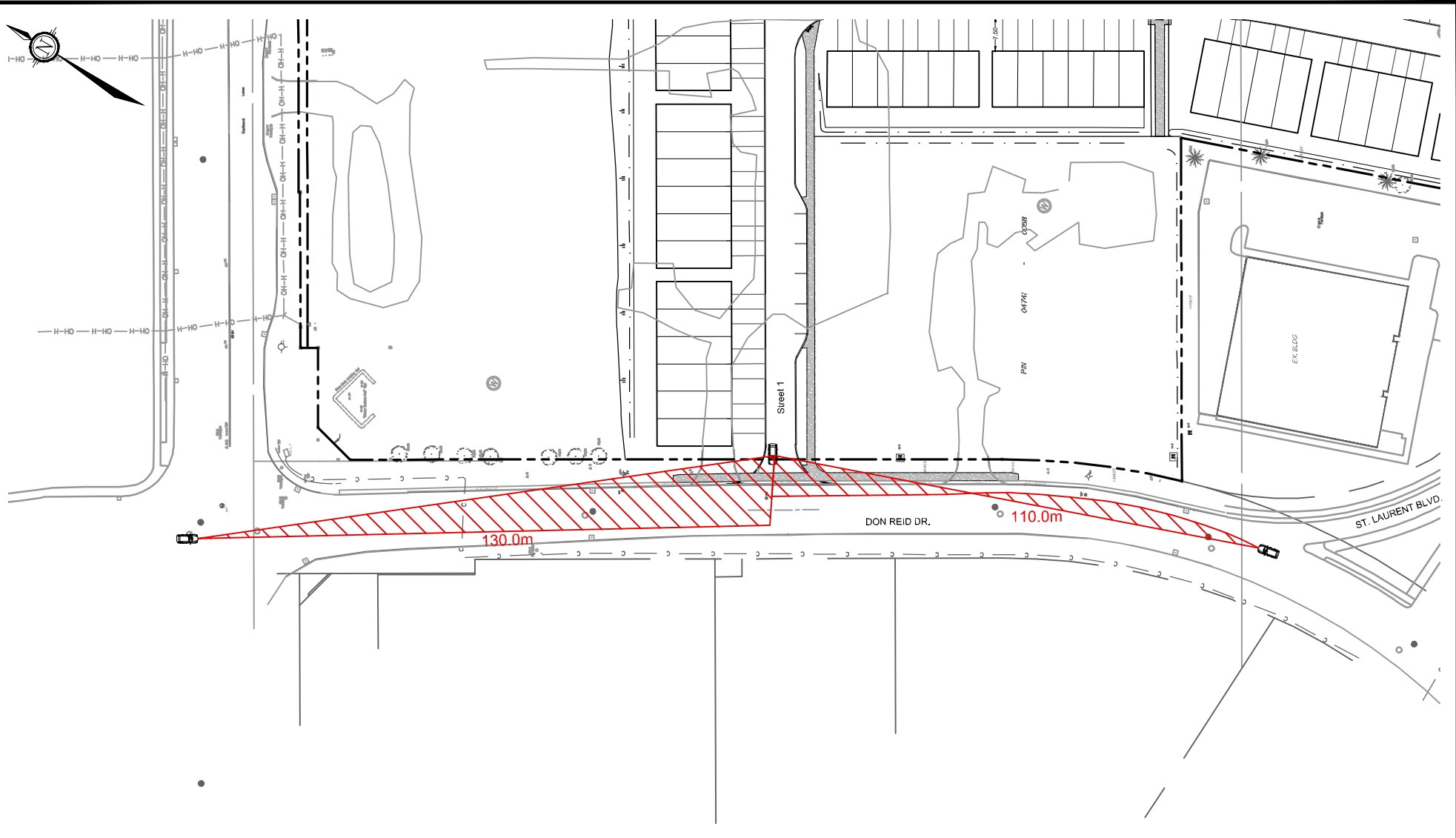

M:\2022\122040\CAD\Civil\Figures\Traffic\122040-SD.dwg, Fig13, Sep 21, 2023 - 6:10pm, rgood



Engineers, Planners & Landscape Architects
 Suite 200, 240 Michael Cowpland Drive
 Ottawa, Ontario, Canada K2M 1P6

Telephone (613) 254-9643
 Facsimile (613) 254-5867
 Website www.novatech-eng.com

2510 ST. LAURENT BLVD.

SIGHT DISTANCE
 DON REID DR & STREET 1

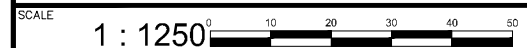

DATE SEP 2023	JOB 122040	FIGURE FIGURE 13
------------------	---------------	---------------------

M:\2022\122040\CAD\Civil\Figures\Traffic\122040-SD.dwg, Fig14, Sep 21, 2023 - 6:10pm, rgood



Engineers, Planners & Landscape Architects
 Suite 200, 240 Michael Cowpland Drive
 Ottawa, Ontario, Canada K2M 1P6

Telephone (613) 254-9643
 Facsimile (613) 254-5867
 Website www.novatech-eng.com

2510 ST. LAURENT BLVD.

SIGHT DISTANCE
 ST. LAURENT BLVD & STREET 2

SCALE 1 : 1250

DATE	JOB	FIGURE
SEP 2023	122040	FIGURE 14

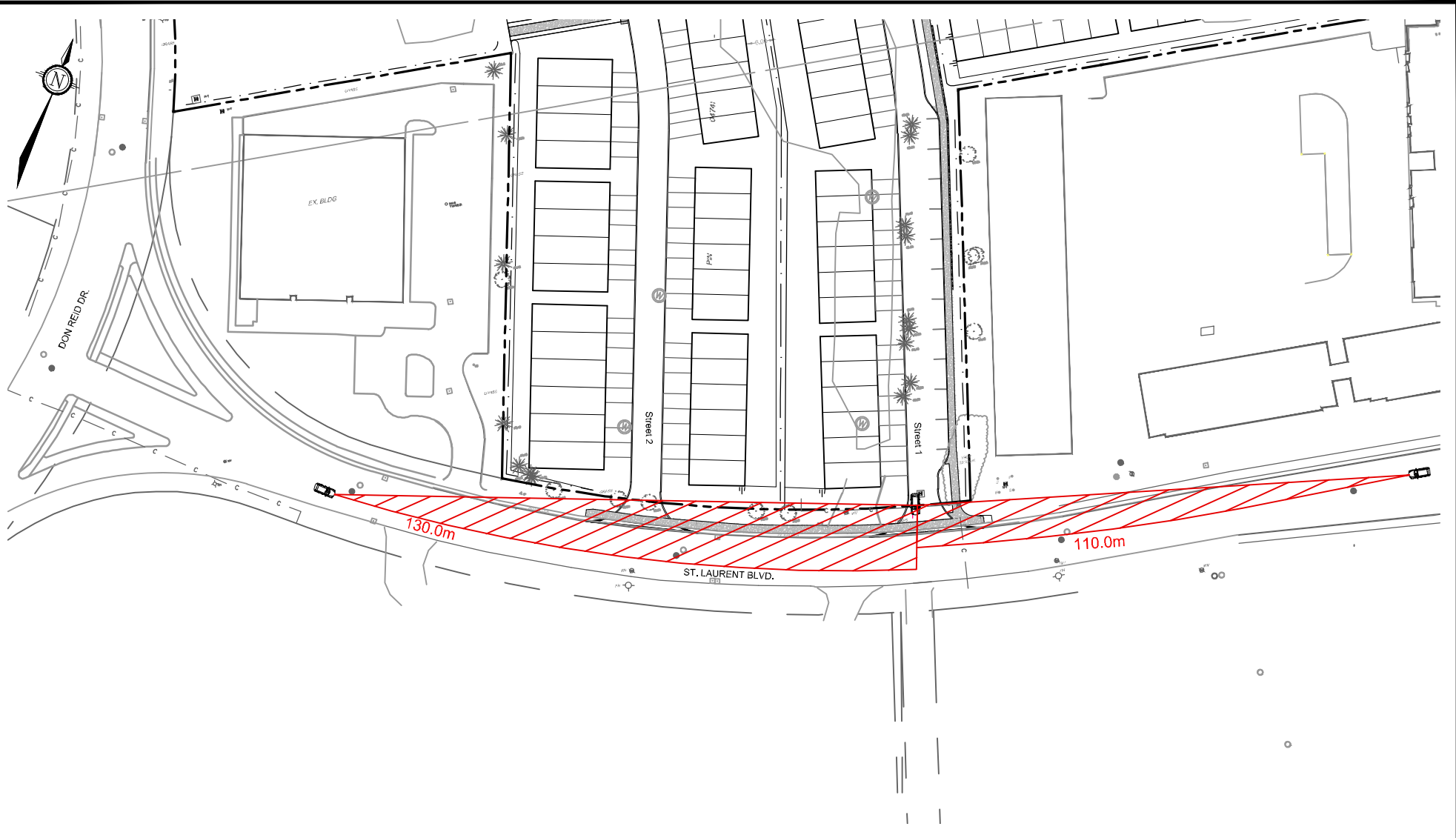

M:\2022\122040\CAD\Civil\Figures\Traffic\122040-SD.dwg, Fig15, Sep 21, 2023 - 6:10pm, rgood



Engineers, Planners & Landscape Architects
 Suite 200, 240 Michael Cowpland Drive
 Ottawa, Ontario, Canada K2M 1P6

Telephone (613) 254-9643
 Facsimile (613) 254-5867
 Website www.novatech-eng.com

2510 ST. LAURENT BLVD.

SIGHT DISTANCE
 ST. LAURENT BLVD & STREET 1

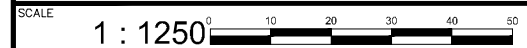

DATE SEP 2023	JOB 122040	FIGURE FIGURE 15
------------------	---------------	---------------------

4.4.2 Access Operations

Analysis of the access intersection operations has been conducted in Synchro, with the results summarized in **Table 19**. The intersection parameters used in the analysis are consistent with the *2017 TIA Guidelines* (Saturated Flow Rate: 1,800 vphpl, Peak Hour Factor: 1.0 in future conditions).

Table 19: 2024/2029 Access Intersection Operations

Access	AM Peak Hour			PM Peak Hour		
	Delay	LOS	Mvmt	Delay	LOS	Mvmt
St. Laurent Boulevard – East Access	10 sec	A	SBL/R	11 sec	B	SBL/R
St. Laurent Boulevard – West Access	10 sec	A	SBL/R	11 sec	B	SBL/R
Don Reid Drive – Access	9 sec	A	WBL/R	10 sec	A	WBL/R

Based on the foregoing, the proposed accesses to St. Laurent Boulevard and Don Reid Drive are anticipated to operate with an acceptable vehicular level of service for the buildout year 2024 and horizon year 2029.

4.5 Transportation Demand Management

4.5.1 Context for TDM

The proposed development will consist of 160 townhouses. A detailed TDM review of the retirement/apartment block, which at this time is anticipated to include 150 retirement home units and 100 apartment units, will be conducted as part of a future Site Plan Control application.

4.5.2 Need and Opportunity

Per Schedule B, the subject site is located in the General Urban Area, and surrounded completely by General Urban Area or Major Open Space north of Walkley Road, and Urban Employment Area south of Walkley Road. As first discussed in Section 3.1.1, the mode share targets for the proposed development are assumed to be generally consistent with the observed multifamily housing mode shares for the Alta Vista region, as outlined in the *TRANS Trip Generation Manual*. These target shares include a 40% driver share.

Failure to meet the already observed driver shares for the Alta Vista region are not anticipated, due to the proximity of the subject site to places of employment to the south, east, and west, as well as commercial areas immediately north of the site and west of Heron Road. Regardless, failure to meet the proposed mode share targets are anticipated to marginally increase congestion within the study area.

4.5.3 TDM Program

A review of the City’s *TDM Measures Checklist* has been conducted by the proponent, who has committed to providing the following TDM measures at the sales centre for this development. A copy of the checklist is included in **Appendix L**.

- Provide local area maps with walking/cycling access routes and key destinations;
- Provide relevant transit schedules and route maps;
- Provide a multimodal travel option information package.

4.6 Neighbourhood Traffic Management

The 2017 TIA Guidelines identify two-way peak hour traffic volume thresholds for considering when a Neighbourhood Traffic Management (NTM) plan should be developed, whenever a site relies on local or collector roadways for access. The NTM two-way volume thresholds are as follows:

- Local Roadways: 120 vehicles during the peak hour, or 1,000 vehicles per day;
- Collector Roadways: 300 vehicles during the peak hour, or 2,500 vehicles per day;
- Major Collector Roadways: 600 vehicles during the peak hour, or 5,000 vehicles per day.

The proposed development will rely on the collector roadways St. Laurent Boulevard and Don Reid Drive for direct access. As shown in Section 2.1.7 and **Figure 5**, the peak hour and daily NTM thresholds for both St. Laurent Boulevard and Don Reid Drive are exceeded by the existing traffic volumes.

Since St. Laurent Boulevard and Don Reid Drive primarily serve industrial, commercial, or office uses, no neighbourhood traffic management measures have been recommended as part of this proposed development.

4.7 Transit

Based on the trip generation estimates presented in Section 3.1.1, the proposed development is anticipated to generate the following number of transit trips:

- AM Peak Hour: 52 transit trips, including 35 boarding and 17 alighting;
- PM Peak Hour: 55 transit trips, including 25 boarding and 30 alighting.

The distribution of transit trips to/from the development has been estimated using the same trip distribution assumptions outlined in Section 3.1.2, which are summarized as follows:

- 15% to/from the south via Conroy Road;
- 10% to/from the east via St. Laurent Boulevard;
- 35% to/from the east via Walkley Road;
- 40% to/from the west via Walkley Road.

Winter 2020 (January 5 to March 7) transit utilization data within the study area was obtained from OC Transpo, and is included in **Appendix C**. This period is considered the most recent 'normal' ridership period, before ridership was impacted by the ongoing COVID-19 pandemic. Average peak period (6:00am to 9:00am and 3:00pm to 6:00pm) boarding, alighting, and bus load at departure information was provided by City staff for stops #4307, #4311, #6927, #8391, and #8398.

Existing and projected boarding and alighting information is summarized in **Table 20**. Any zero (0) values in the table indicate a measured average boarding or alighting value of zero, rather than an absence of data. Peak period boarding and alighting data have been converted to peak hour boardings and alightings, using factors of 0.55 for the AM peak hour and 0.47 for the PM peak hour (per the *TRANS Trip Generation Manual*).

Table 20: Existing and Projected Transit Utilization

Stop	Location	Route (Direction)	Boarding (tph) ⁽¹⁾			Alighting (tph) ⁽¹⁾			
			Existing	Site	Total	Existing	Site	Total	
AM Peak Hour									
#4307	St. Laurent/Conroy	40	SB	1	5	6	31	1	32
#4311	St. Laurent/Conroy	40	NB	2	4	6	7	3	10
#6927	Walkley/Don Reid	46	EB	3	12	15	9	7	16
#8391	Walkley/Ryder	46	WB	2	7	9	2	6	8
#8398	Ryder/Walkley	291	IB	5	7	12	1	-	1
PM Peak Hour									
#4307	St. Laurent/Conroy	40	SB	5	4	9	9	3	12
#4311	St. Laurent/Conroy	40	NB	23	3	26	1	5	6
#6927	Walkley/Don Reid	46	EB	4	4	8	4	3	7
#8391	Walkley/Ryder	46	WB	3	5	8	1	5	6
		140	EB	0	4	4	0	3	3
			WB	0	5	5	0	5	5
		291	OB	0	-	0	1	6	7

A discussion of the site-generated impacts to each route during the weekday peak hours is included below.

Route 40 (to St. Laurent)

At stop #4311, the proposed development is estimated to generate a net addition of four AM boarding trips, three AM alighting trips, three PM boarding trips, and five PM alighting trips. As Route 40 runs on approximately 15-minute intervals during the peak hours, this equates to an addition of one AM boarding trip, AM alighting trip, PM boarding trip, and PM alighting trip per bus during the peak hours. Therefore, these additional transit trips are not anticipated to require more frequent service at these stops.

Route 40 (to Greenboro)

At stop #4307, the proposed development is estimated to generate a net addition of five AM boarding trips, one AM alighting trip, four PM boarding trips, and three PM alighting trips. As Route 40 runs on approximately 15-minute intervals during the peak hours, this equates to an addition of two AM boarding trips, one AM alighting trip, one PM boarding trip, and one PM alighting trip per bus during the peak hours. Therefore, these additional transit trips are not anticipated to require more frequent service at these stops.

Route 46 (to Hurdman)

At stop #6927, the proposed development is estimated to generate a net addition of 12 AM boarding trips, seven AM alighting trips, four PM boarding trips, and three PM alighting trips. As Route 46 runs on approximately 30-minute intervals during the peak hours, this equates to an addition of six AM boarding trips, four AM alighting trips, two PM boarding trips, and two PM alighting trips per bus during the peak hours. Therefore, these additional transit trips are not anticipated to require more frequent service at these stops.

Route 46 (to Billings Bridge)

At stop #8391, the proposed development is estimated to generate a net addition of seven AM boarding trips, six AM alighting trips, five PM boarding trips, and five PM alighting trips. As Route 46 runs on approximately 30-minute intervals during the peak hours, this equates to an addition of four AM boarding trips, three AM alighting trips, three PM boarding trips, and three PM alighting trips per bus during the peak hours. Therefore, these additional transit trips are not anticipated to require more frequent service at these stops.

Route 140 (to Heron Park)

At stop #8391, the proposed development is estimated to generate a net addition of four PM boarding trips and three PM alighting trips. As Route 140 runs on approximately 30-minute intervals during the peak hours, this equates to an addition of two PM boarding trips and two PM alighting trips per bus during the peak hours. Therefore, these additional transit trips are not anticipated to require more frequent service at these stops.

Route 140 (to Billings Bridge)

At stop #8391, the proposed development is estimated to generate a net addition of five PM boarding trips and five PM alighting trips. As Route 140 runs on approximately 30-minute intervals during the peak hours, this equates to an addition of three PM boarding trips and three PM alightings trip per bus during the peak hours. Therefore, these additional transit trips are not anticipated to require more frequent service at these stops.

Route 291 (to Hurdman)

At stop #8398, the proposed development is estimated to generate a net addition of seven AM boarding trips. As Route 291 runs on approximately 30-minute intervals during the peak hours, this equates to an addition of four boarding trips per bus during the AM peak hour. Therefore, these additional transit trips are not anticipated to require more frequent service at these stops.

Route 291 (to Herongate)

At stop #8391, the proposed development is estimated to generate a net addition of six PM alighting trips. As Route 291 runs on approximately 30-minute intervals during the peak hours, this equates to an addition of three alighting trips per bus during the PM peak hour. Therefore, these additional transit trips are not anticipated to require more frequent service at these stops.

4.8 Intersection Design

4.8.1 Intersection MMLOS Review

This section provides a review of the signalized study area intersections (Walkley Road/Don Reid Drive/Ryder Street, Walkley Road/160m West of Conroy Road, Walkley Road/Conroy Road, and St. Laurent Boulevard/Conroy Road) using complete streets principles. The signalized intersections within the study area have been evaluated for PLOS, BLOS, TLOS, and TklOS, based on existing conditions. The MMLOS targets considered in this review are associated with those outlined in Exhibit 22 of the *MMLOS Guidelines* for the General Urban Area or Employment Area, whichever targets are stricter.

The full intersection MMLOS analysis is included in **Appendix M**. A summary of the results is shown in **Table 21**.

Table 21: Intersection MMLOS Summary

Intersection	PLOS		BLOS		TLOS		TkLOS	
	Actual	Target	Actual	Target	Actual	Target	Actual	Target
Walkley Road/ Don Reid Drive/Ryder Street	F	C	F	B	E	B	E	B
Walkley Road/ 160m West of Conroy Road	F	C	F	B	B	B	E	B
Walkley Road/ Conroy Road	F	C	F	B	F	B	A	B
St. Laurent Boulevard/ Conroy Road	F	C	F	B	D	D	E	B

The results of the intersection MMLOS analysis can be summarized as follows:

- No signalized intersections meet the target PLOS;
- No signalized intersections meet the target BLOS;
- Walkley Road/160m West of Conroy Road and St. Laurent Boulevard/Conroy Road meets the target TLOS, while Walkley Road/Don Reid Drive/Ryder Street and Walkley Road/Conroy Road do not;
- Walkley Road/Conroy Road meets the target TkLOS, while Walkley Road/Don Reid Drive/Ryder Street, Walkley Road/160m West of Conroy Road, and St. Laurent Boulevard/Conroy Road do not.

Walkley Road/Don Reid Drive/Ryder Street

The intersection does not meet the target PLOS C, BLOS B, TLOS B, or TkLOS B.

All approaches do not meet the target PLOS C, and have cross-sections equivalent to five to nine lanes crossed. Per the *MMLOS Guidelines*, every 3.5m in crossing distance is equivalent to one lane crossed. There is limited opportunity in improving the PLOS at each approach without reducing the number of travel lanes. No approaches meet the City’s vehicle/pedestrian conflict threshold for zebra-striped crosswalks (greater than 400,000 vehicle/pedestrian conflicts over an eight-hour period).

All approaches do not meet the target BLOS B based on left turn characteristics. Per Exhibit 12 of the *MMLOS Guidelines*, the target BLOS can only be achieved by implementing two-stage, left-turn bike boxes. Implementing bike boxes would also require restricting right turns on red (RTOR) for each approach. This is identified for the City’s consideration.

The north and west approaches do not meet the target TLOS B. No recommendations are identified for the north approach, which is Ryder Street (i.e. a local roadway with no transit priority designation). It is anticipated that the target TLOS B will be met at the west approach, upon completion of the Baseline/Heron/Walkley/St. Laurent BRT project.

The east and west approaches do not meet the target TkLOS B. The TkLOS at these approaches represent the level of accommodation for trucks turning right from Walkley Road onto Don Reid Drive or Ryder Street (i.e. roadways that are not designated as truck routes with limited heavy vehicle volumes), and therefore no recommendations are identified.

Walkley Road/160m West of Conroy Road

The intersection does not meet the target PLOS C, BLOS B, or TkLOS B.

All approaches do not meet the target PLOS C, and have cross-sections equivalent to six or seven lanes crossed. There is limited opportunity in improving the PLOS at each approach without reducing the number of travel lanes. No approaches meet the City's vehicle/pedestrian conflict threshold for zebra-striped crosswalks.

The east approach does not meet the target BLOS B based on left turn characteristics, and the south approach does not meet the target BLOS B based on right turn characteristics. The south approach is a private approach to 1950 Walkley Road, and therefore no recommendations are identified. Per Exhibit 12 of the *MMLOS Guidelines*, the target BLOS can only be achieved at the east approach by implementing a jug-handle, crossside, and bicycle traffic signal for cyclists to enter the private approach to 1950 Walkley Road. This is identified for the City's consideration.

The west approach does not meet the target TkLOS B. The TkLOS at this approach represents the level of accommodation for trucks turning right into 1950 Walkley Road (i.e. an existing private approach to commercial/retail uses), and therefore no recommendations are identified.

Walkley Road/Conroy Road

The intersection does not meet the target PLOS C, BLOS B, or TLOS B.

The south and east approaches do not meet the target PLOS C, and have cross-sections equivalent to nine or ten lanes crossed. There is limited opportunity in improving the PLOS at each approach without reducing the number of travel lanes or removing the westbound and northbound right turn channels. Both approaches meet the City's vehicle/pedestrian conflict threshold for zebra-striped crosswalks. This is identified for the City's consideration. While this would improve the level of comfort for pedestrians, the provision of zebra-striped crosswalks alone will not improve the PLOS for either approach.

The south and east approaches do not meet the target BLOS B based on left turn characteristics, and the south and west approaches do not meet the target BLOS based on right turn characteristics. From a left-turn perspective and per Exhibit 12 of the *MMLOS Guidelines*, the target BLOS can only be achieved by implementing left-turn bike facilities. This would include a bike box for cyclists arriving from the south approach, and a jug-handle, crossside, and bicycle traffic signal for cyclists arriving from the east approach. This is identified for the City's consideration.

From a right-turn perspective, Exhibit 12 of the *MMLOS Guidelines* identifies that the target BLOS B can be achieved with pocket bike lanes, as long as the right turn lane is less than 50m in length, and is introduced to the right of the pocket bike lane. Based on the existing queue lengths of the northbound and eastbound right turn movements, this is not recommended. Therefore, the provision of separated cycling facilities (like the existing multi-use pathway on the west side of Conroy Road) is identified for the City's consideration.

All approaches do not meet the target TLOS. It is anticipated that the target TLOS B will be met at the east and west approaches, upon completion of the Baseline/Heron/Walkley/St. Laurent BRT project. As Conroy Road is designated as a Transit Priority Corridor with Isolated Measures (with a target TLOS D), it is anticipated that the implementation of measures such as queue jump lanes or transit priority signals would improve the TLOS of the south approach to a TLOS D.

St. Laurent Boulevard/Conroy Road

The intersection does not meet the target PLOS C, BLOS B, or TkLOS B.

All approaches do not meet the target PLOS C, and have cross-sections equivalent to six lanes crossed or more. There is limited opportunity in improving the PLOS at each approach without reducing the number of travel lanes or removing the westbound right turn channel. No approaches meet the City’s vehicle/pedestrian conflict threshold for zebra-striped crosswalks.

All approaches do not meet the target BLOS B based on left turn characteristics, and the east and west approaches do not meet the target BLOS based on right turn characteristics. From a left-turn perspective and per Exhibit 12 of the *MMLOS Guidelines*, the target BLOS can only be achieved by implementing two-stage, left-turn bike boxes. Implementing bike boxes would also require RTOR restrictions for the north and south approaches. This is identified for the City’s consideration.

From a right-turn perspective, Exhibit 12 of the *MMLOS Guidelines* identifies that the target BLOS B can be achieved by implementing a curbside bike lane for the east approach and a pocket bike lane for the west approach. This is identified for the City’s consideration.

The north and south approaches do not meet the target TkLOS B. The TkLOS at these approaches represent the level of accommodation for trucks turning right from Conroy Road onto St. Laurent Boulevard (i.e. a roadway that is not designated as a truck route with limited heavy vehicle volumes), and therefore no recommendations are identified.

4.8.2 2024 Total Intersection Operations

Intersection capacity analysis has been conducted for the 2024 total traffic conditions. The analysis included below is based on an earlier concept plan with a higher number of townhouses, and is therefore conservative. The results of the analysis are summarized in **Table 22** and **Table 23** for the weekday AM and PM peak hours. Detailed reports are included in **Appendix N**.

Table 22: 2024 Total Traffic Operations

Intersection	Period	Critical Movements			Intersection		
		Max v/c or Delay	LOS	Mvmt	v/c	Delay	LOS
Walkley Road/ Don Reid Drive/Ryder Street ⁽¹⁾	AM	0.71	C	WBT/R	0.63	9 sec	B
	PM	0.83	D	NBL	0.68	17 sec	B
Walkley Road/ 160m West of Conroy Road ⁽¹⁾	AM	0.62	B	WBT	0.53	7 sec	A
	PM	0.59	A	EBT	0.57	5 sec	A
Walkley Road/ Conroy Road ⁽¹⁾	AM	0.84	D	NBL	0.68	27 sec	B
	PM	0.85	D	WBL	0.83	27 sec	D
St. Laurent Boulevard/ Conroy Road ⁽¹⁾	AM	0.43	A	NBT/R	0.41	12 sec	A
	PM	0.77	C	EBR	0.67	23 sec	B
St. Laurent Boulevard/ Don Reid Drive ⁽²⁾	AM	12 sec	B	WBL	-		
	PM	11 sec	B	WBL			

1. Signalized intersection
2. Unsignalized intersection

Table 23: 2024 Total Queues

Intersection	Mvmt	Storage/Spacing ⁽¹⁾	AM Peak			PM Peak		
			v/c [LOS]	50 th % Queue (m)	95 th % Queue (m)	v/c [LOS]	50 th % Queue (m)	95 th % Queue (m)
Walkley Rd/Don Reid Dr/Ryder St	NBL	35m	0.52 [A]	17	26	0.83 [D]	34	53
	WBT/R	140m	0.66 [B]	27	30	0.66 [B]	122	50
Walkley Rd/160m West of Conroy Rd	WBT	130m	0.63 [B]	50	121	0.53 [A]	59	112
Walkley Rd/Conroy Rd	EBT	130m	0.55 [A]	67	91	0.84 [D]	72	#149
	WBL	200m	0.66 [B]	27	38	0.85 [D]	50	#73

1. Indicates the storage length for auxiliary lanes or the spacing to the nearest upstream intersection for through lanes
 #: volume for the 95th percentile cycle exceeds capacity

Compared to the 2024 background traffic conditions, site-generated traffic is anticipated to have marginal impacts on traffic operations within the study area.

4.8.3 2029 Total Intersection Operations

Intersection capacity analysis has been conducted for the 2029 total traffic conditions. The results of the analysis are summarized in **Table 24** and **Table 25** for the weekday AM and PM peak hours. Detailed reports are included in **Appendix N**.

Table 24: 2029 Total Traffic Operations

Intersection	Period	Critical Movements			Intersection		
		Max v/c or Delay	LOS	Mvmt	v/c	Delay	LOS
Walkley Road/Don Reid Drive/Ryder Street ⁽¹⁾	AM	0.71	C	WBT/R	0.66	9 sec	B
	PM	0.83	D	NBL	0.73	18 sec	C
Walkley Road/160m West of Conroy Road ⁽¹⁾	AM	0.67	B	WBT	0.58	8 sec	A
	PM	0.65	B	EBT	0.63	6 sec	B
Walkley Road/Conroy Road ⁽¹⁾	AM	0.87	D	NBL	0.75	29 sec	C
	PM	0.96	E	EBT	0.91	31 sec	E
St. Laurent Boulevard/Conroy Road ⁽¹⁾	AM	0.46	A	SBL	0.43	12 sec	A
	PM	0.77	C	EBR	0.69	23 sec	B
St. Laurent Boulevard/Don Reid Drive ⁽²⁾	AM	12 sec	B	WBL	-		
	PM	11 sec	B	WBL			

1. Signalized intersection
 2. Unsignalized intersection

Table 25: 2029 Total Queues

Intersection	Mvmt	Storage/Spacing ⁽¹⁾	AM Peak			PM Peak		
			v/c [LOS]	50 th % Queue (m)	95 th % Queue (m)	v/c [LOS]	50 th % Queue (m)	95 th % Queue (m)
Walkley Rd/Don Reid Dr/Ryder St	NBL	35m	0.51 [A]	16	26	0.83 [D]	34	53
	WBT/R	140m	0.71 [C]	28	#191	0.75 [C]	145	51
Walkley Rd/160m West of Conroy Rd	WBT	130m	0.67 [B]	59	143	0.61 [B]	75	143
Walkley Rd/Conroy Rd	EBT	130m	0.70 [B]	92	121	0.96 [E]	~112	#181
	WBL	200m	0.67 [B]	28	40	0.88 [D]	54	#79

1. Indicates the storage length for auxiliary lanes or the spacing to the nearest upstream intersection for through lanes
 #: volume for the 95th percentile cycle exceeds capacity
 ~: approach is above capacity

Compared to the 2029 background traffic conditions, site-generated traffic is anticipated to have marginal impacts on traffic operations within the study area. The alternate timing discussed in Sections 3.4.1 and 3.4.3 (increasing the green time for the eastbound-westbound phases) has been reviewed, and the analysis indicates that this mitigation allows the eastbound through movement to operate at the target Auto LOS D. Detailed reports of this alternate scenario are included in **Appendix N**.

5.0 CONCLUSIONS AND RECOMMENDATIONS

The conclusions and recommendations of this TIA can be summarized as follows:

Forecasting

- The proposed development is estimated to generate 170 person trips (including 67 vehicle trips) during the AM peak hour, and 193 person trips (including 79 vehicle trips) during the PM peak hour.

Development Design and Parking

- In general, the proposed development includes a pavement width of 6.5m to 6.7m for on-site roadways with perpendicular parking spaces or no on-street parking. Parallel parking spaces are provided on the south side of Street 1 (adjacent to the public park), the east side of Street 1 (adjacent to 2500 St. Laurent Boulevard), and on the north side of Street 3 (adjacent to the commercial access serving 1950 Walkley Road and 2980 Conroy Road). These parallel parking spaces are provided as lay-bys, to maintain a narrower pavement width outside of these spaces and reduce the operating speed of vehicles on-site.
- On-site concrete sidewalks will be provided along the south side of Street 1 between Don Reid Drive and Street 3, the east side of Street 1, the south side of Street 3, and the east side of the additional lands to the north. Midblock pathways will also be provided between the proposed public park and Street 2, and between Street 2 and Street 1 at Street 3. These sidewalks will connect the proposed development to the proposed parkland fronting Don Reid Drive, and to the existing sidewalks along Conroy Road, St. Laurent Boulevard, and Don Reid Drive.
- Any required TDM-supportive design and infrastructure measures in the TDM checklist that are relevant to townhouse developments have been met.
- Garbage collection will take place curbside in front of the proposed dwellings. The on-site fire route will include all private roadways within the subject site.
- The minimum parking requirements will be met. As every proposed dwelling will include their own garage, the ZBL does not identify any minimum bicycle parking requirements.

Boundary Streets

- The results of the segment multi-modal level of service (MMLOS) analysis can be summarized as follows:
 - No boundary street meets the target pedestrian level of service (PLOS);
 - No boundary street meets the target bicycle level of service (BLOS);
 - Conroy Road meets the target transit level of service (TLOS), while Walkley Road does not;
 - All boundary streets meet the target truck level of service (TkLOS).

- Both sides of Walkley Road and Conroy Road do not meet the target PLOS C. Walkley Road can achieve the target PLOS C and Conroy Road can achieve a PLOS D by implementing sidewalks with a minimum width of 2.0m and a minimum boulevard width of 2.0m. This is identified for the City's consideration.
- The south side of St. Laurent Boulevard and west side of Don Reid Drive do not meet the target PLOS C, as sidewalks are only provided on one side of each roadway. Implementing curbside sidewalks with a minimum width of 1.8m are sufficient to achieve the target PLOS. This is identified for the City's consideration. The existing sidewalks on St. Laurent Boulevard and Don Reid Drive meet the target PLOS C, and therefore no recommendations for these sidewalks are identified. Any sidewalks that need to be reconstructed as a result of the proposed development will be reinstated to a width of 1.8m.
- Walkley Road does not meet the target BLOS B. The target BLOS B can only be achieved through the implementation of physically separated bikeways along Walkley Road. This is identified for the City's consideration.
- St. Laurent Boulevard and Don Reid Drive do not meet the target BLOS B. The target BLOS B can be achieved by providing curbside bike lanes with a minimum width of 1.5m, and reducing the operating speed to 50 km/h.
- Walkley Road does not meet the target TLOS B, which is achieved by providing bus lanes with no or limited parking/driveway friction. It is anticipated that this target will be met upon completion of the Baseline/Heron/Walkley/St. Laurent BRT project, which is anticipated to occur beyond 2031.

Access Intersections

- The proposed development includes two full-movement accesses to St. Laurent Boulevard and one full-movement access to Don Reid Drive. Depressed curbs and continuous sidewalks are proposed along the entirety of each access, in accordance with City standards. The design of each access meets the relevant provisions of the City's *Private Approach By-Law*.
- The proposed access to Don Reid Drive will have clear sightlines to Walkley Road to the north and St. Laurent Boulevard to the south. The proposed accesses to St. Laurent Boulevard are located on the inside of a slight curve, but will still achieve the sightlines recommended by the Transportation Association of Canada (TAC), provided that any vegetation within the ROW of St. Laurent Boulevard is trimmed and maintained. Therefore, no sightline concerns are anticipated.
- The proposed accesses to St. Laurent Boulevard and Don Reid Drive are anticipated to operate with an acceptable vehicular level of service for the buildout year 2024 and horizon year 2029.

Transportation Demand Management

- A review of the City's *TDM Measures Checklist* has been conducted by the proponent, who has committed to providing the following TDM measures at the sales centre:
 - Provide local area maps with walking/cycling access routes and key destinations;
 - Provide relevant transit schedules and route maps;
 - Provide a multimodal travel option information package.

Neighbourhood Traffic Management

- The peak hour and daily NTM thresholds for both St. Laurent Boulevard and Don Reid Drive are exceeded by the existing traffic volumes. Since St. Laurent Boulevard and Don Reid Drive primarily serve industrial, commercial, or office uses, no neighbourhood traffic management measures have been recommended as part of this proposed development.

Transit

- The proposed development is anticipated to generate 52 AM peak hour transit trips, (including 35 boarding and 17 alighting), and 55 PM peak hour transit trips (including 25 boarding and 30 alighting). These additional transit trips are not anticipated to require more frequent service at any stops within the study area.

Intersection MMLOS

- The results of the intersection MMLOS analysis can be summarized as follows:
 - No signalized intersections meet the target PLOS;
 - No signalized intersections meet the target BLOS;
 - Walkley Road/160m West of Conroy Road and St. Laurent Boulevard/Conroy Road meets the target TLOS, while Walkley Road/Don Reid Drive/Ryder Street and Walkley Road/Conroy Road do not;
 - Walkley Road/Conroy Road meets the target TkLOS, while Walkley Road/Don Reid Drive/Ryder Street, Walkley Road/160m West of Conroy Road, and St. Laurent Boulevard/Conroy Road do not.
- All approaches at the study area intersections do not meet the target PLOS C. There is limited opportunity in improving the PLOS at each approach without reducing the number of travel lanes or removing right turn channels where applicable. The south and east approaches at Walkley Road/Conroy Road meet the City's vehicle/pedestrian conflict threshold to consider zebra-striped crosswalks.
- For approaches with failing BLOS based on left turn characteristics, the target BLOS can be achieved by implementing two-stage, left-turn cycling facilities. Implementing bike boxes would also require restricting right turns on red (RTOR). This is identified for the City's consideration.
- The south approach of Walkley Road/160m West of Conroy Road, the south and west approaches of Walkley Road/Conroy Road, and the east and west approaches of St. Laurent Boulevard/Conroy Road do not meet the target BLOS based on right turn characteristics. The provision of separated cycling facilities on Walkley Road and the east side of Conroy Road, and bike lanes on St. Laurent Boulevard is identified for the City's consideration.
- The north and west approaches of Walkley Road/Don Reid Drive/Ryder Street and all approaches of Walkley Road/Conroy Road do not meet the target TLOS B. It is anticipated that the target TLOS will be met on Walkley Road upon completion of the Baseline/Heron/Walkley/St. Laurent BRT project, and on Conroy Road with the implementation of isolated transit priority measures. No recommendations are identified for Ryder Street (i.e. a local roadway with no transit priority designation).

- Any approaches that do not meet the target T_kLOS represent right turns into private approaches or onto local/collector roadways with no truck route designation, and therefore no recommendations are identified.

Existing Traffic Operations

- The eastbound through and westbound left turn movements at Walkley Road/Conroy Road operate at an Auto LOS E during the PM peak hour.
- During the AM peak hour, the Synchro analysis identifies that the maximum (95th-percentile) queue lengths of the westbound through movements at Walkley Road/Don Reid Drive/Ryder Street and Walkley Road/160m West of Conroy Road extend into the upstream intersections on Walkley Road.
- During the PM peak hour, the Synchro analysis identified that the maximum queue length of the northbound left turn movement at Walkley Road/Don Reid Drive/Ryder Street exceeds the storage length of the auxiliary northbound left turn, but is contained within the taper. The maximum queue length of the eastbound through movement at Walkley Road/Conroy Road extends into the upstream intersection on Walkley Road.

Background Traffic Operations

- Compared to the existing conditions, improvements in some movements is due to differences in the Peak Hour Factor parameter (0.9 in existing conditions and 1.0 in future conditions, per the *2017 TIA Guidelines*).
- The eastbound through movement at Walkley Road/Conroy Road operates at an Auto LOS E during the PM peak hour. Increasing the green time for the eastbound-westbound phases has been reviewed, and the analysis indicates that this mitigation allows the eastbound through movement to operate at the target Auto LOS D.

Total Traffic Operations

- Compared to the future background traffic conditions, site-generated traffic is anticipated to have marginal impacts on traffic operations within the study area.

Based on the foregoing, the proposed development is recommended from a transportation perspective.

NOVATECH

Prepared by:



Joshua Audia, P.Eng.
Project Engineer | Transportation

Reviewed by:



Brad Byvelds, P.Eng.
Project Manager | Transportation

APPENDIX A

Proposed Site Plan

LEGEND

- Site Plan Boundary
- 5.2m Garage Setback
- 1.8m Building Setback
- Proposed Sanitary Manhole
- Proposed Storm Manhole
- ▣ Proposed Box Manhole
- ▣ Proposed Catchbasin Box Manhole
- ⊙ Proposed Catchbasin Manhole
- ▣ Proposed Catchbasin
- ◇ Proposed Fire Hydrant
- Proposed Tactile Walking Surface Indicator (TWSI)
- Proposed Landscape Drain

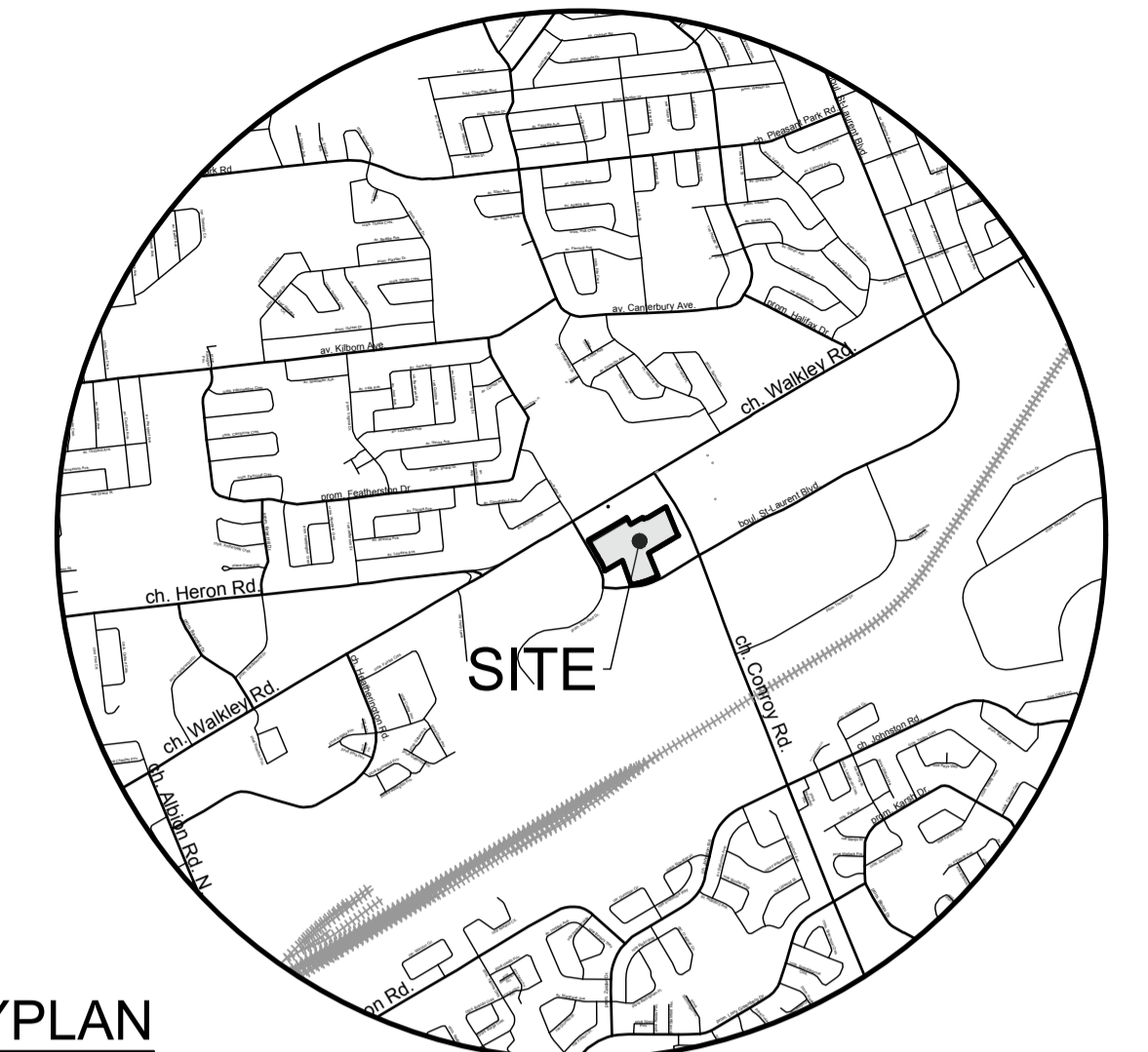
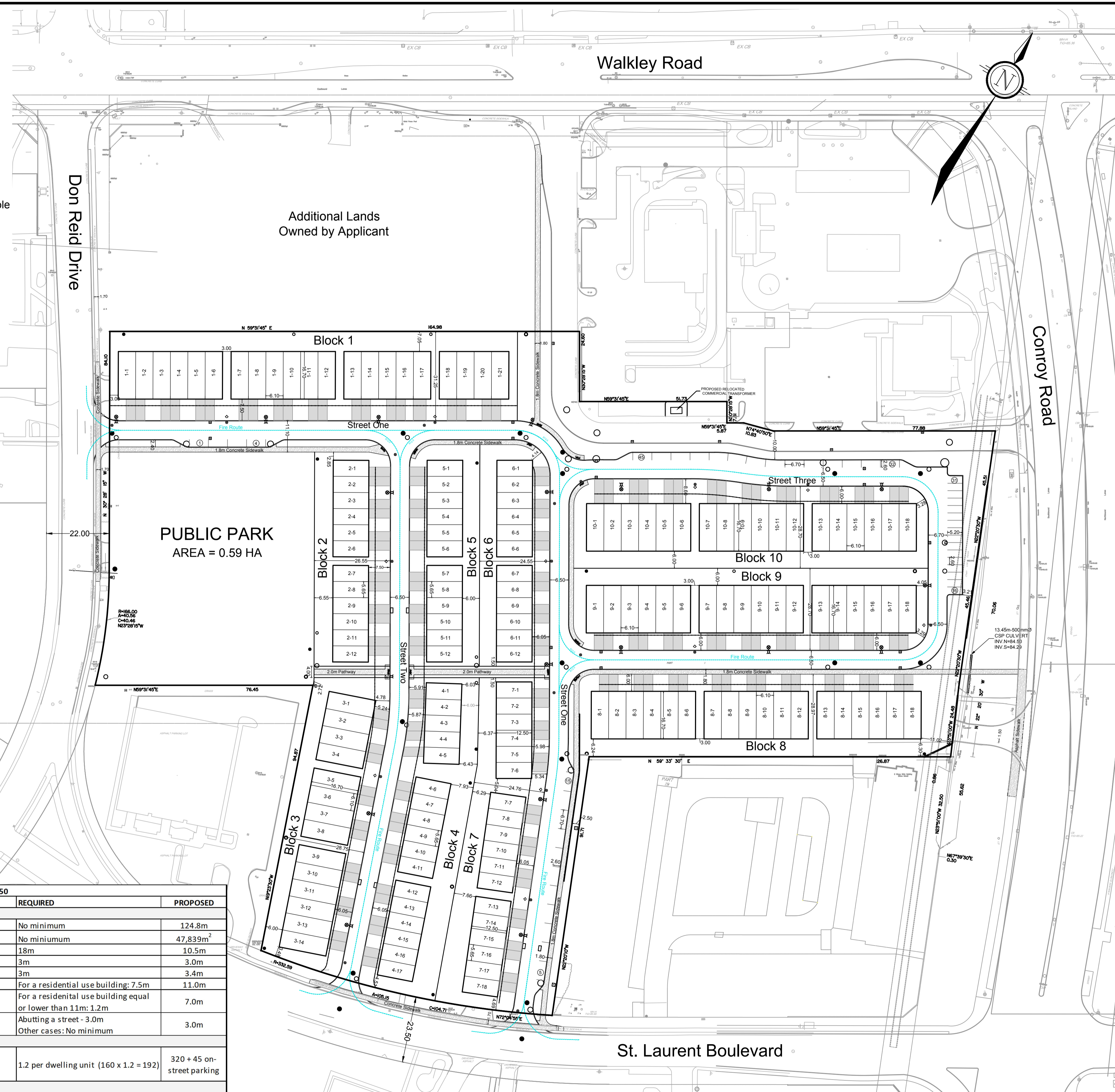

KEYPLAN
NOT TO SCALE

SITE PLAN

2510 ST. LAURENT BOULEVARD

PART OF LOTS A AND I
CONCESSION 4 (RIDEAU FRONT)
Geographic Township of Gloucester
CITY OF OTTAWA



Developer: Claridge Homes
505 Preston St
Ottawa, ON
K1S 4N7
(Telephone) 613-233-6030

Engineer: Novatech
240 Michael Cowpland Drive, Suite 200
Ottawa, ON
K2M 1P6
(Telephone) 613-254-9643

Surveyor: Annis O'Sullivan Vollebakk Ltd.
14 Concourse Gate, Suite 500
Nepean, ON
K2E 7S6
(Telephone) 613-727-0850



ZONING PROVISIONS - ZONING BY-LAW 2008-250		
PROVISION	REQUIRED	PROPOSED
GENERAL MIXED USE (GM)		
MIN LOT WIDTH	No minimum	124.8m
MIN LOT AREA	No minimum	47,839m ²
MAX BUILDING HEIGHT	18m	10.5m
MIN FRONT YARD SETBACK	3m	3.0m
MIN CORNER SIDE YARD SETBACK	3m	3.4m
MIN REAR YARD SETBACK	For a residential use building: 7.5m	11.0m
MIN INTERIOR SIDE YARD SETBACK	For a residential use building equal or lower than 11m: 1.2m	7.0m
MIN WIDTH OF LANDSCAPED AREA	Abutting a street - 3.0m Other cases: No minimum	3.0m
PARKING RATES		
RESIDENT/VISITOR COMBINED (townhouse)		
Resident (1.0/dwelling unit)	1.2 per dwelling unit (160 x 1.2 = 192)	320 + 45 on-street parking
Visitor (0.2/dwelling unit)		
LANDSCAPED AREA AROUND PARKING LOTS		
MIN WIDTH OF LANDSCAPED BUFFER	Abutting a street - 11 to 99 spaces: 3m	3.2m
PLANNED UNIT DEVELOPMENT (PUD)		
MIN WIDTH OF PRIVATE WAY	6m	6.5m
MIN SETBACK FOR ANY WALL OF A RESIDENTIAL USE BUILDING TO A PRIVATE WAY	1.8m	3.2m
MIN SETBACK FOR ANY GARAGE OR CARPORT ENTRANCE TO A PRIVATE WAY	5.2m	5.2m
MIN SEPARATION BETWEEN BUILDINGS WITHIN A PUD WHERE THE HEIGHTS OF ABUTTING BUILDINGS IS LESS THAN OR EQUAL TO 14.5m	1.2m	3.0m

St. Laurent Boulevard

SOURCE REFERENCE:
 Legal Information: *Topographical Plan of Survey Annis, O'Sullivan, Vollebakk Ltd. / August, 2022 / MTM Zone 9 / NAD 83 ORIG*
 Topographic Information: *Topographical Plan of Survey Annis, O'Sullivan, Vollebakk Ltd. / August, 2022 / MTM Zone 9 / NAD 83 ORIG*
 Topographic Information: 1:1000
 City of Ottawa / 2017 / MTM Zone 9 / NAD 83 ORIG

No.	REVISION	DATE	BY
6	REVISED PER COMMENTS	SEPT 11/23	RT
5	ISSUED FOR COORDINATION	MAY 17/23	RT
4	ISSUED FOR CITY REVIEW	APR 21/23	RT
3	ISSUED FOR CITY REVIEW	NOV 01/22	EP
2	ISSUED FOR CLIENT REVIEW	OCT 11/22	EP
1	PREPARED FOR DISCUSSION	SEPT 09/22	EP

 Engineers, Planners & Landscape Architects Suite 200, 240 Michael Cowpland Drive Ottawa, Ontario, Canada K2M 1P6 Telephone (613) 254-9643 Facsimile (613) 254-5867 Website www.novatech-eng.com	ISSUED SEPTEMBER, 2023
	PROJECT No. 122040
	DRAWING No. 122040-SP

M:\2021\122040\CAD\Planning\Site Plans\122040-SP.dwg, SP-A1, Sep 11, 2023, 1:10pm, wcds

D07-12-22-0155

#XXXXX

APPENDIX B

TIA Screening Form

City of Ottawa 2017 TIA Guidelines Screening Form

1. Description of Proposed Development

Municipal Address	1900-1902 Walkley Road, 2425 Don Reid Drive, 2510 St. Laurent Boulevard, and 3000 Conroy Road
Description of Location	Located north of St. Laurent Boulevard, south of Walkley Road, east of Don Reid Drive, and west of Conroy Road
Land Use Classification	Townhouses
Development Size (units)	160 townhouse dwellings, 150 retirement dwellings, and 100 apartment dwellings
Development Size (m ²)	-
Number of Accesses and Locations	Two accesses to St. Laurent Boulevard and one access to Don Reid Drive
Phase of Development	1
Buildout Year	2024

If available, please attach a sketch of the development or site plan to this form.

2. Trip Generation Trigger

Considering the Development's Land Use type and Size (as filled out in the previous section), please refer to the Trip Generation Trigger checks below.

Land Use Type	Minimum Development Size
Single-family homes	40 units
<i>Townhomes or apartments</i>	<i>90 units</i>
Office	3,500 m ²
Industrial	5,000 m ²
Fast-food restaurant or coffee shop	100 m ²
Destination retail	1,000 m ²
Gas station or convenience market	75 m ²

** If the development has a land use type other than what is presented in the table above, estimates of person-trip generation may be made based on average trip generation characteristics represented in the current edition of the Institute of Transportation Engineers (ITE) Trip Generation Manual.*

If the proposed development size is greater than the sizes identified above, the Trip Generation Trigger is satisfied.

3. Location Triggers

	Yes	No
Does the development propose a new driveway to a boundary street that is designated as part of the City's Transit Priority, Rapid Transit or Spine Bicycle Networks?		✓
Is the development in a Design Priority Area (DPA) or Transit-oriented Development (TOD) zone?*		✓

*DPA and TOD are identified in the City of Ottawa Official Plan (DPA in Section 2.5.1 and Schedules A and B; TOD in Annex 6). See Chapter 4 for a list of City of Ottawa Planning and Engineering documents that support the completion of TIA).

If any of the above questions were answered with 'Yes,' the Location Trigger is satisfied.

4. Safety Triggers

	Yes	No
Are posted speed limits on a boundary street are 80 km/hr or greater?		✓
Are there any horizontal/vertical curvatures on a boundary street limiting sight lines at a proposed driveway?		✓
Is the proposed driveway within the area of influence of an adjacent traffic signal or roundabout (i.e. within 300 m of intersection in rural conditions, or within 150 m of intersection in urban/suburban conditions)?	✓	
Is the proposed driveway within auxiliary lanes of an intersection?	✓	
Does the proposed driveway make use of an existing median break that serves an existing site?		✓
Is there is a documented history of traffic operations or safety concerns on the boundary streets within 500 m of the development?		✓
Does the development include a drive-thru facility?		✓

If any of the above questions were answered with 'Yes,' the Safety Trigger is satisfied.

5. Summary

	Yes	No
Does the development satisfy the Trip Generation Trigger?	✓	
Does the development satisfy the Location Trigger?		✓
Does the development satisfy the Safety Trigger?	✓	

If none of the triggers are satisfied, the TIA Study is complete. If one or more of the triggers is satisfied, the TIA Study must continue into the next stage (Screening and Scoping).

APPENDIX C

OC Transpo Route Information

40

ST-LAURENT GREENBORO

Fréquent

7 days a week / 7 jours par semaine

All day service
Service toute la journée

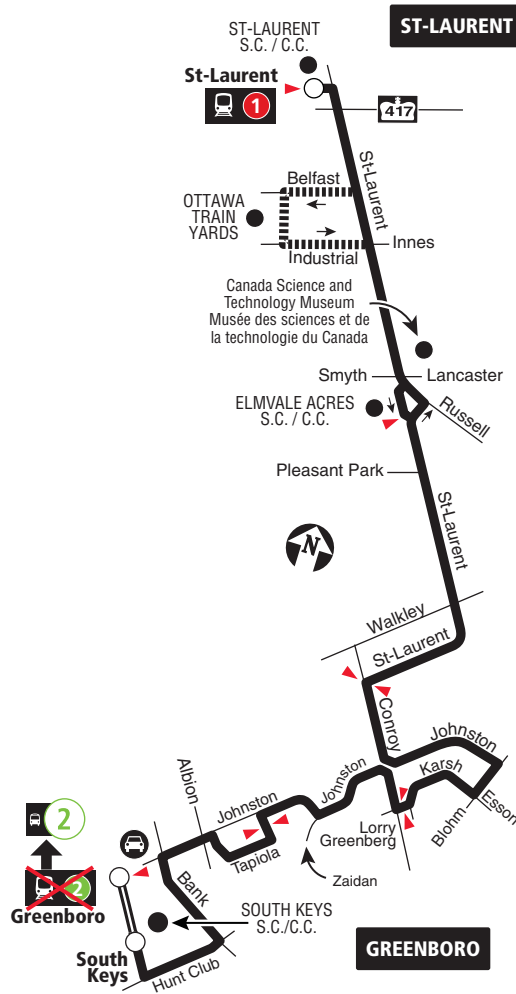

- Transitway & Station
- Some trips early morning only /
Quelques trajets tôt le matin seulement
- Park & Ride / Parc-o-bus
- Timepoint / Heures de passage

2021.06

Schedule / Horaire 613-560-1000
Text / Texto* 560560
plus your four digit bus stop number / plus votre numéro d'arrêt à quatre chiffres
*Standard message rates may apply / Les tarifs réguliers de messagerie texte peuvent s'appliquer

Customer Service
Service à la clientèle **613-741-4390**

Lost and Found / Objets perdus..... **613-563-4011**

Security / Sécurité **613-741-2478**

Effective June 20, 2021
En vigueur 20 juin 2021

INFO 613-741-4390
octranspo.com



46

BILLINGS BRIDGE HURDMAN

Local

7 days a week / 7 jours par semaine
All day service
Service toute la journée

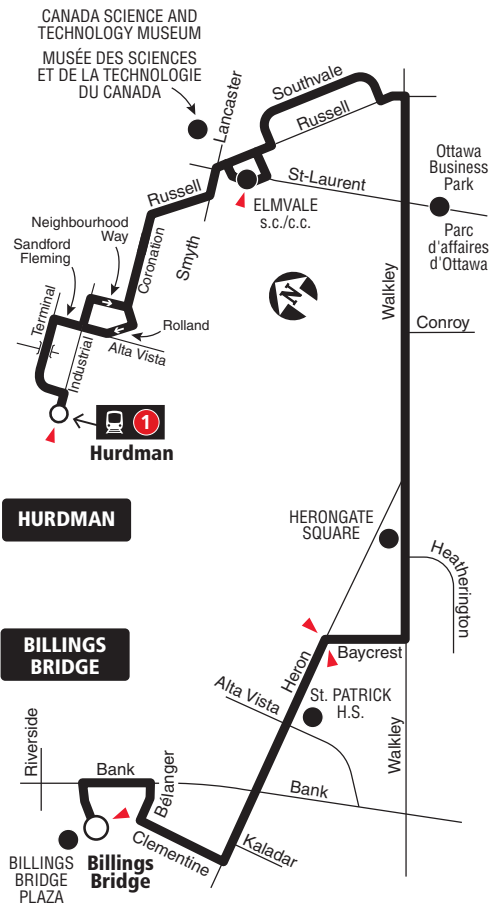

HURDMAN

BILLINGS BRIDGE

○ Station
▲ Timepoint / Heures de passage

2019.07





Future route after O-Train Line 1 is open
Trajet du circuit après l'ouverture de la Ligne 1 de l'O-Train

Lost and Found / Objets perdus..... 613-563-4011
Security / Sécurité..... 613-741-2478

OC Transpo INFO 613-741-4390
octranspo.com



140

HERON PARK BILLINGS BRIDGE

Local



Monday to Saturday / Lundi au samedi

Limited service during the day
Service limité pendant la journée

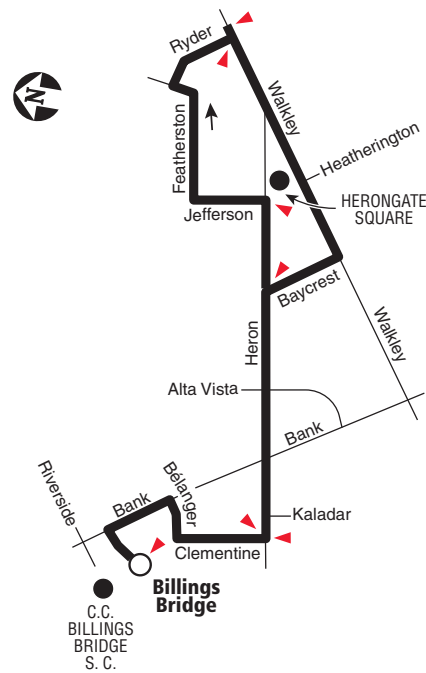
HERON PARK



BILLINGS BRIDGE

-  Station
-  Timepointe / Heures de passage

2019.07



Future route after O-Train Line 1 is open
Trajet du circuit après l'ouverture de la Ligne 1 de l'O-Train

Lost and Found / Objets perdus..... 613-563-4011
 Security / Sécurité 613-741-2478

 **INFO 613-741-4390**
 octranspo.com

FORMER / ANCIEN 41

291

HURDMAN HERONGATE

Connexion

Monday to Friday / Lundi au vendredi

Peak periods only

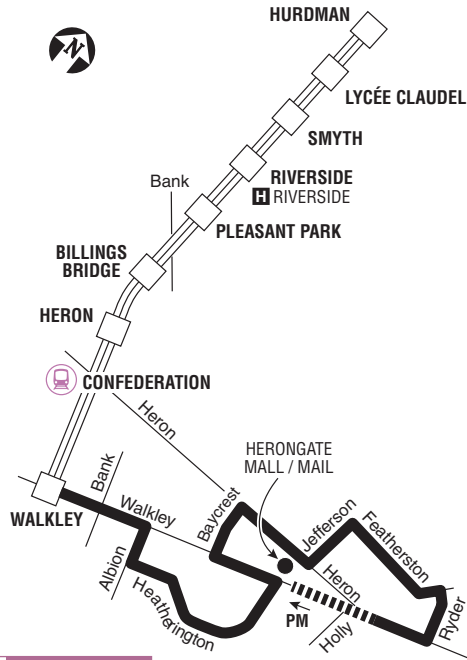

Périodes de pointe seulement

AM
↑
HURDMAN



PM
↓
HERONGATE

Legend • Légende

-  Transitway & Station
-  Line 2 – O-Train Trillium Line
Ligne 2 - O-Train Ligne Trillium
-  PM only / *PM seulement*

2017.06



Schedule / Horaire..... 613-560-1000

Text / Texto560560

plus your four digit bus stop number / plus votre numéro d'arrêt à quatre chiffres

Customer Relations

Service à la clientèle **613-842-3600**

Lost and Found / Objets perdus..... **613-563-4011**

Security / Sécurité **613-741-2478**

Effective June 26, 2017

En vigueur 26 juin 2017



INFO 613-741-4390
octranspo.com

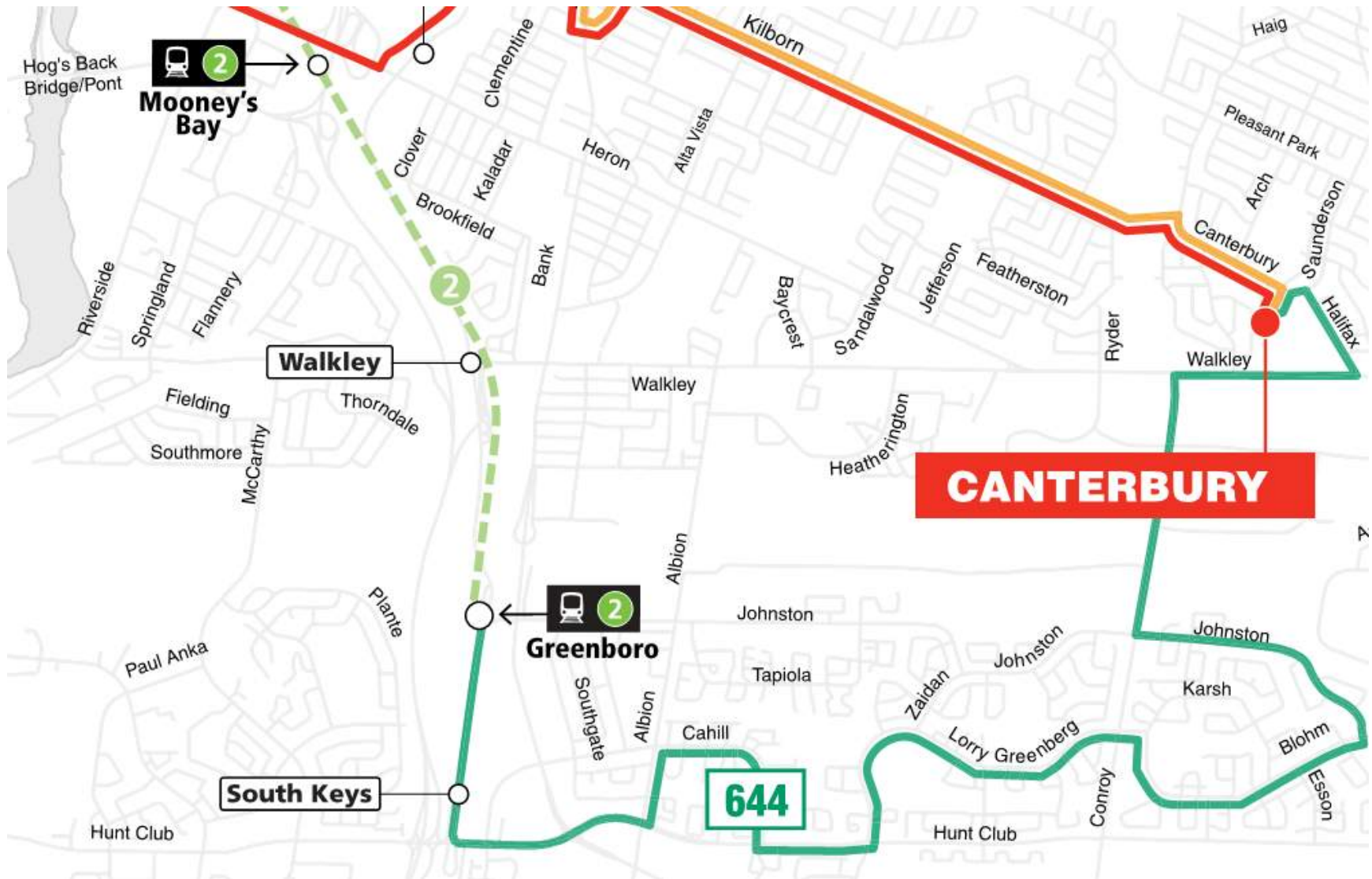

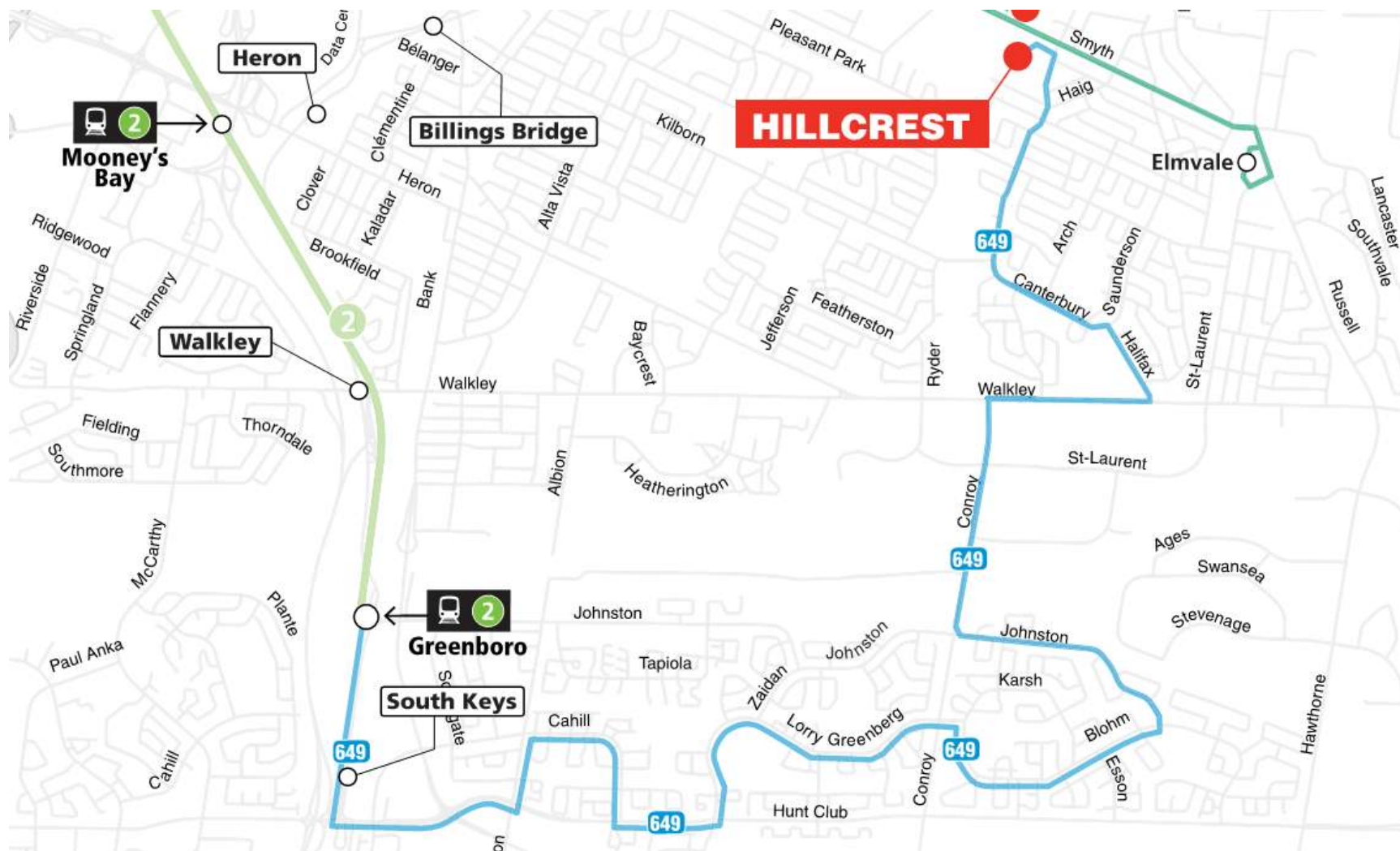

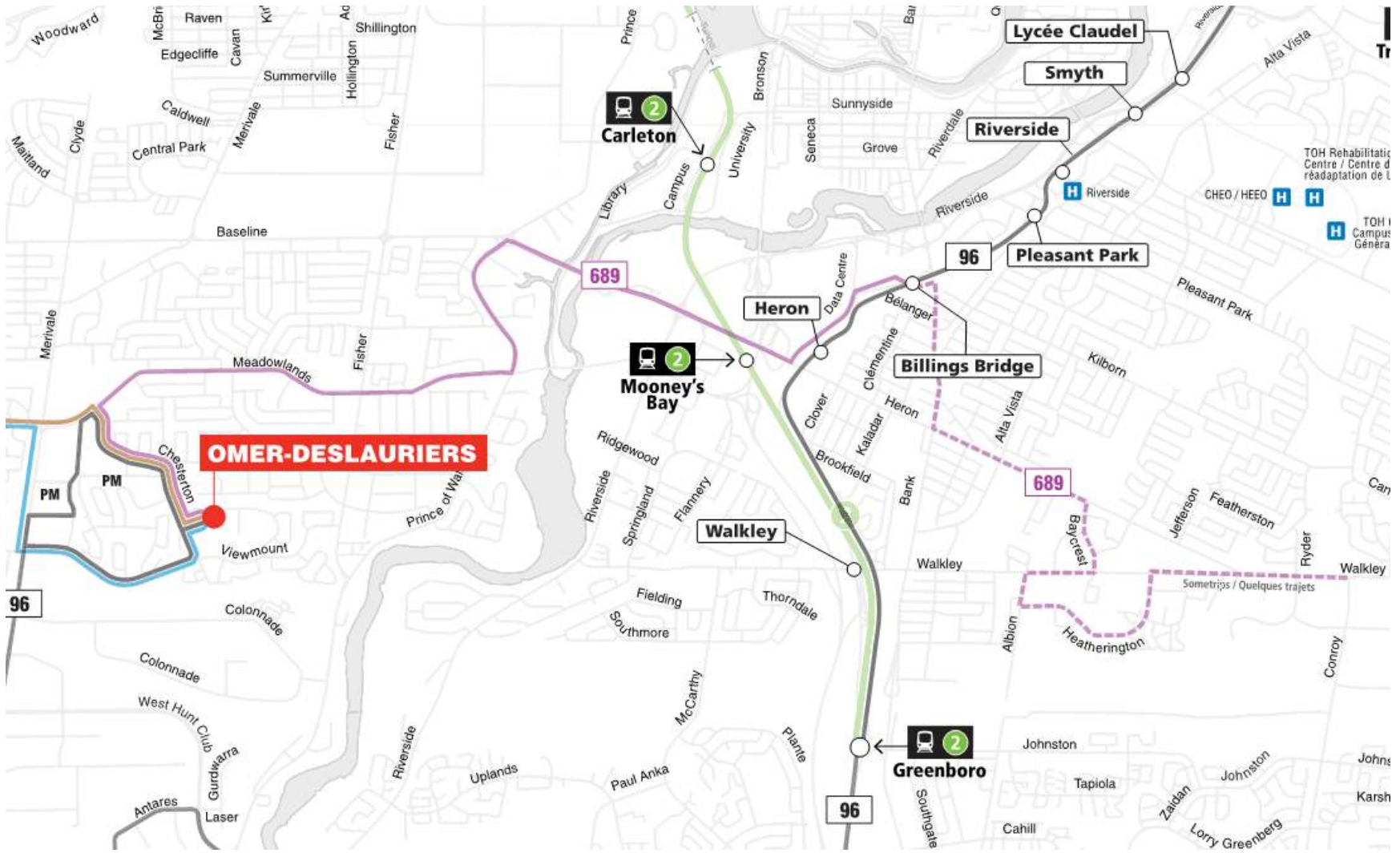

OMER-DESLAURIERS

Carleton

Mooney's Bay

Heron

Billings Bridge

Walkley

Greenboro

Lycée Claudel

Smyth

Riverside

Pleasant Park

96

689

96

689

96

TOH Rehabilitation Centre / Centre d'adaptation de l

CHEO / HÉEO H H

TOH Campus Généra H

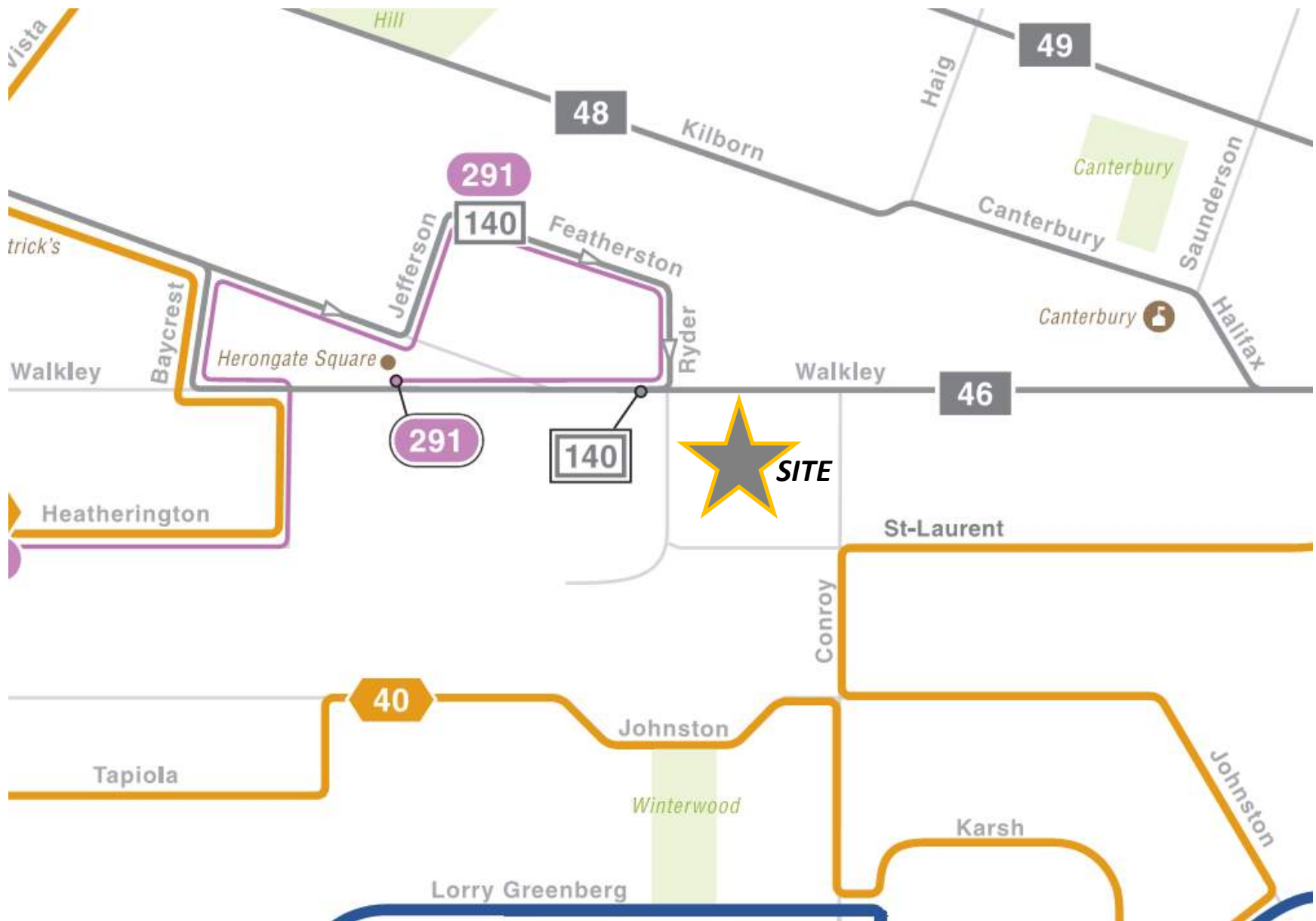

Joshua Audia

Subject: FW: Transit Data Request - Walkley/Conroy area

Hi Josh,

The requested data is below. Note that I pared down the list of stops a bit: what's shown below should provide a suitable representative sample to cover the routes in the area. Please let me know if you need any other data.

Data was sampled from the period of January 5 to March 16 2020, which is the last normal ridership period before pandemic-related impacts began. Note that cells with a zero (0) value indicate a measured average value of zero, based on available APC data, rather than an absence of data. Cells with a dash (-) indicate that that route in question does not service the stop in the given time period.

Winter 2020 (Jan 5 - Mar 16)

Stop	Location	Route (Direction)		AM (6:00 - 9:00)			PM (15:00 - 18:00)			24-hr		
				Boardings	Alightings	Avg Load at Departure	Boardings	Alightings	Avg Load at Departure	Boardings	Alightings	Avg Load at Departure
4307	St-Laurent/Conroy	40	SB	1	56	3	10	19	8	30	143	6
4311	St-Laurent/Conroy	40	NB	3	12	7	48	2	6	121	27	7
6927	Walkley/Don Reid	46	EB	5	16	13	7	9	15	15	40	12
8391	Walkley/Ryder	46	WB	4	3	16	6	2	17	20	10	12
		140	EB	-	-	-	0	0	0	0	7	0
			WB	-	-	-	0	0	0	9	0	1
			OB	-	-	-	0	3	1	0	5	1
8398	Ryder/Walkley	291	IB	8	1	1	-	-	-	8	1	1

Please let me know if there are any questions, or if any additional information is required.

Best,

Graham Rathwell

Transit Planner, Network Service Design
Service Planning Branch
Transit Services Department
OC Transpo | City of Ottawa

APPENDIX D

Traffic Count Data

Turning Movement Count - Peak Hour Diagram

WALKLEY RD @ DON REID DR/Ryder ST

Survey Date: Tuesday, November 29, 2016

Start Time: 07:00

WO No: 36554

Device: Miovision

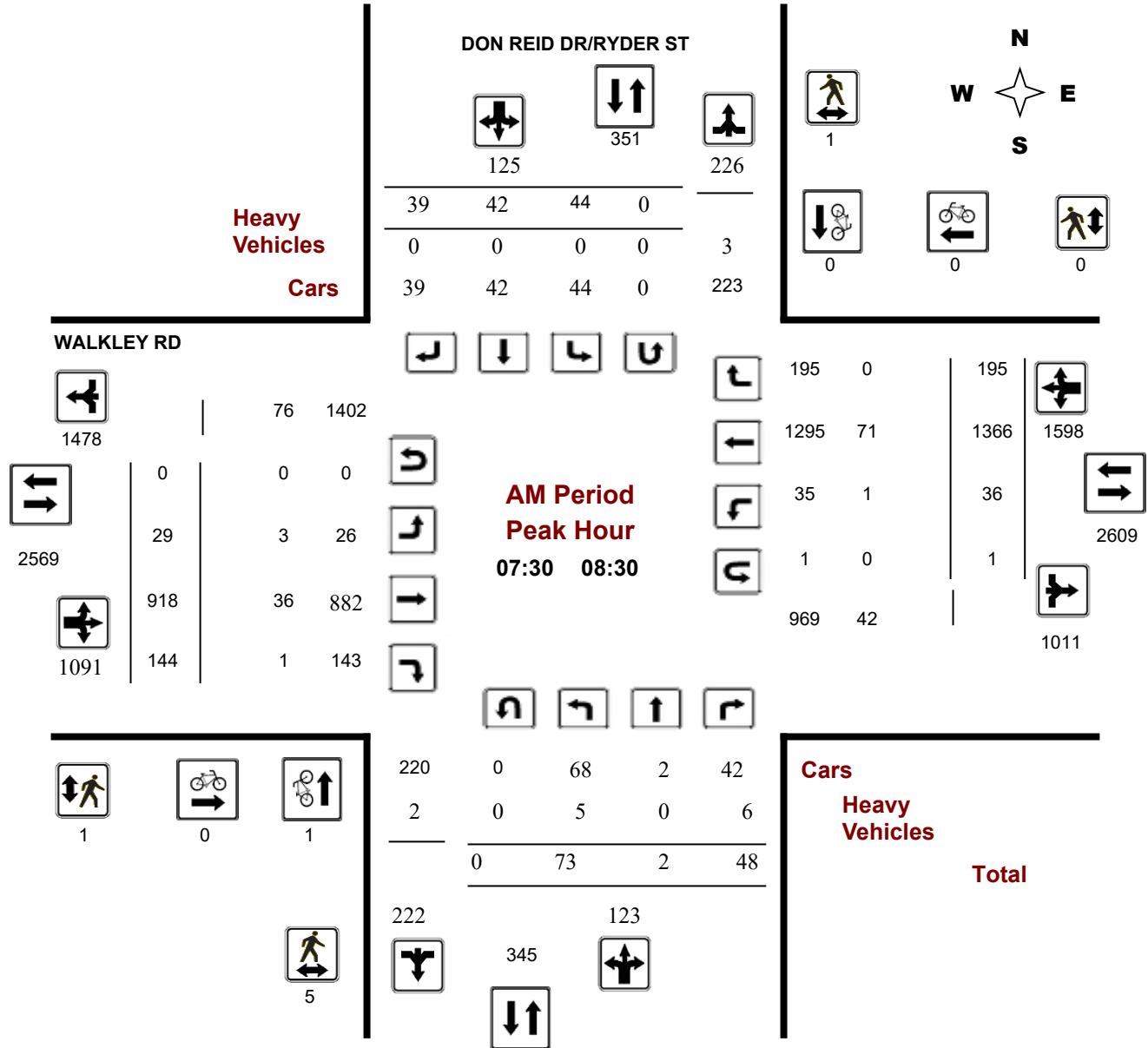

Comments

Turning Movement Count - Peak Hour Diagram

WALKLEY RD @ DON REID DR/Ryder ST

Survey Date: Tuesday, November 29, 2016

Start Time: 07:00

WO No: 36554

Device: Miovision

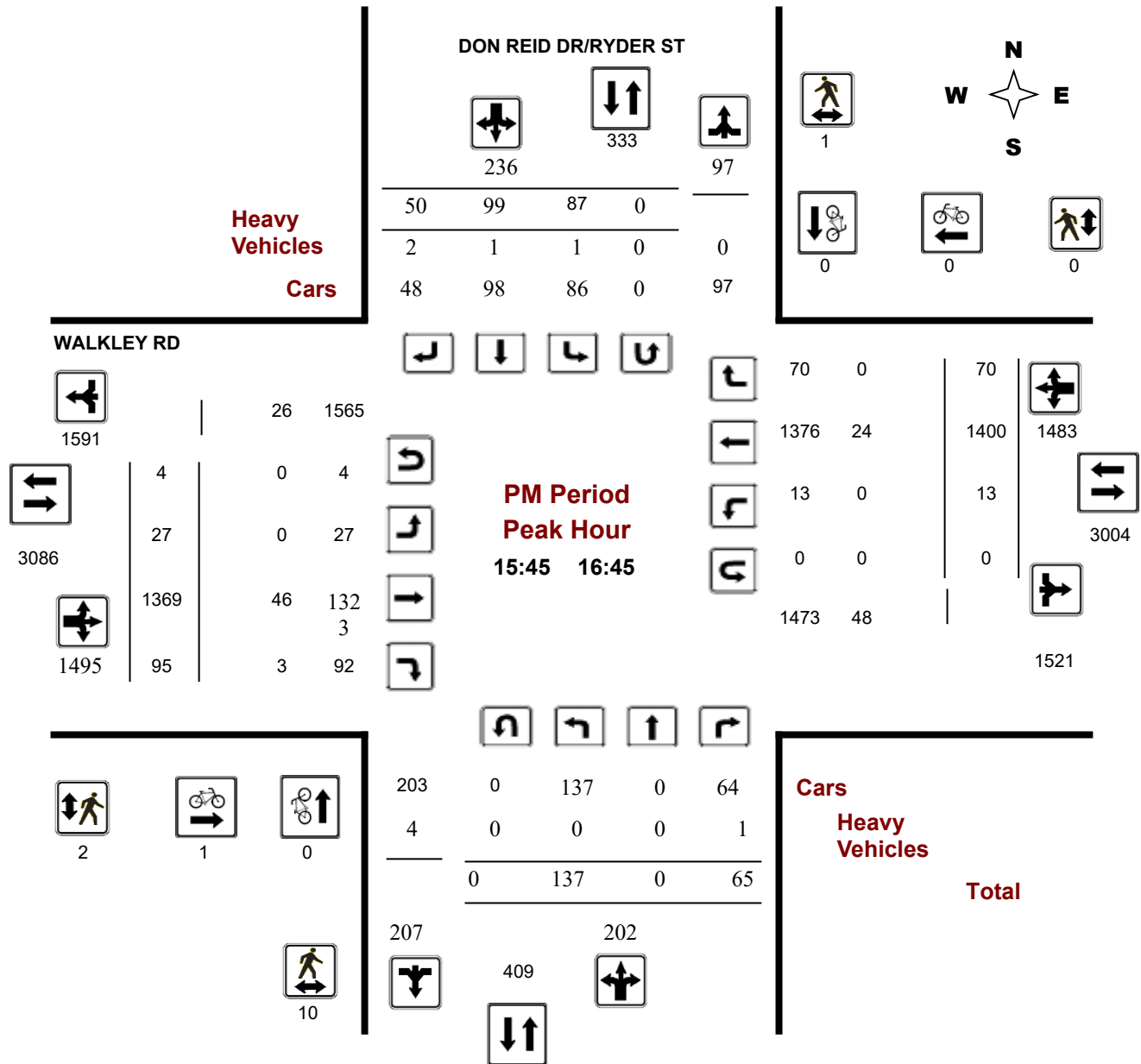



Transportation Services - Traffic Services

Turning Movement Count - Study Results WALKLEY RD @ DON REID DR/Ryder ST

Survey Date: Tuesday, November 29, 2016

WO No: 36554

Start Time: 07:00

Device: Miovision

Full Study Summary (8 HR Standard)

Survey Date: Tuesday, November 29, 2016

Total Observed U-Turns
 Northbound: 0 Southbound: 1
 Eastbound: 14 Westbound: 3

AADT Factor
1.00

DON REID DR/Ryder ST

WALKLEY RD

Period	Northbound					Southbound					Eastbound					Westbound					Grand Total
	LT	ST	RT	NB TOT	STR TOT	LT	ST	RT	SB TOT	STR TOT	LT	ST	RT	EB TOT	STR TOT	LT	ST	RT	WB TOT	STR TOT	
07:00 08:00	56	0	28	84	176	35	24	33	92	176	24	845	123	992	2344	38	1159	155	1352	2344	2520
08:00 09:00	66	5	40	111	229	38	45	35	118	229	34	909	157	1100	2670	30	1345	195	1570	2670	2899
09:00 10:00	51	1	35	87	183	41	22	33	96	183	19	710	78	807	1745	23	855	60	938	1745	1928
11:30 12:30	78	1	80	159	243	33	21	30	84	243	30	792	69	891	2088	25	873	56	954	1845	2088
12:30 13:30	58	0	59	117	213	37	22	37	96	213	18	864	91	973	2148	28	886	48	962	1935	2148
15:00 16:00	87	0	55	142	348	85	74	47	206	348	27	1291	90	1408	3238	18	1385	79	1482	2890	3238
16:00 17:00	142	1	72	215	443	76	101	51	228	443	33	1382	100	1515	3409	10	1367	74	1451	2966	3409
17:00 18:00	95	5	34	134	303	62	62	45	169	303	26	1217	67	1310	2862	6	1178	65	1249	2559	2862
Sub Total	633	13	403	1049	2138	407	371	311	1089	2138	211	8010	775	8996	21092	178	9048	732	9958	18954	21092
U Turns	0			0	0	0			0	0	0			0	0				0	0	0
Total	633	13	403	1049	2138	407	371	311	1089	2138	211	8010	775	8996	21092	178	9048	732	9958	18954	21092

EQ 12Hr 880 18 560 1458 567 516 432 1515 2973 313 11134 1077 12524 252 12577 1017 13846 26370 29343
 Note: These values are calculated by multiplying the totals by the appropriate expansion factor. **1.39**

AVG 12Hr 880 18 560 1458 567 516 432 1515 2973 313 11134 1077 12524 252 12577 1017 13846 26370 29343
 Note: These volumes are calculated by multiplying the Equivalent 12 hr. totals by the AADT factor. **1.00**

AVG 24Hr 1153 24 734 1911 743 676 566 1985 3896 410 14586 1411 16407 330 16476 1332 18138 34545 38441
 Note: These volumes are calculated by multiplying the Average Daily 12 hr. totals by 12 to 24 expansion factor. **1.31**

Note: U-Turns provided for approach totals. Refer to 'U-Turn' Report for specific breakdown.

Turning Movement Count - Peak Hour Diagram

WALKLEY RD @ DON REID DR/Ryder ST

Survey Date: Thursday, January 20, 2022

Start Time: 07:00

WO No: 40069

Device: Miovision

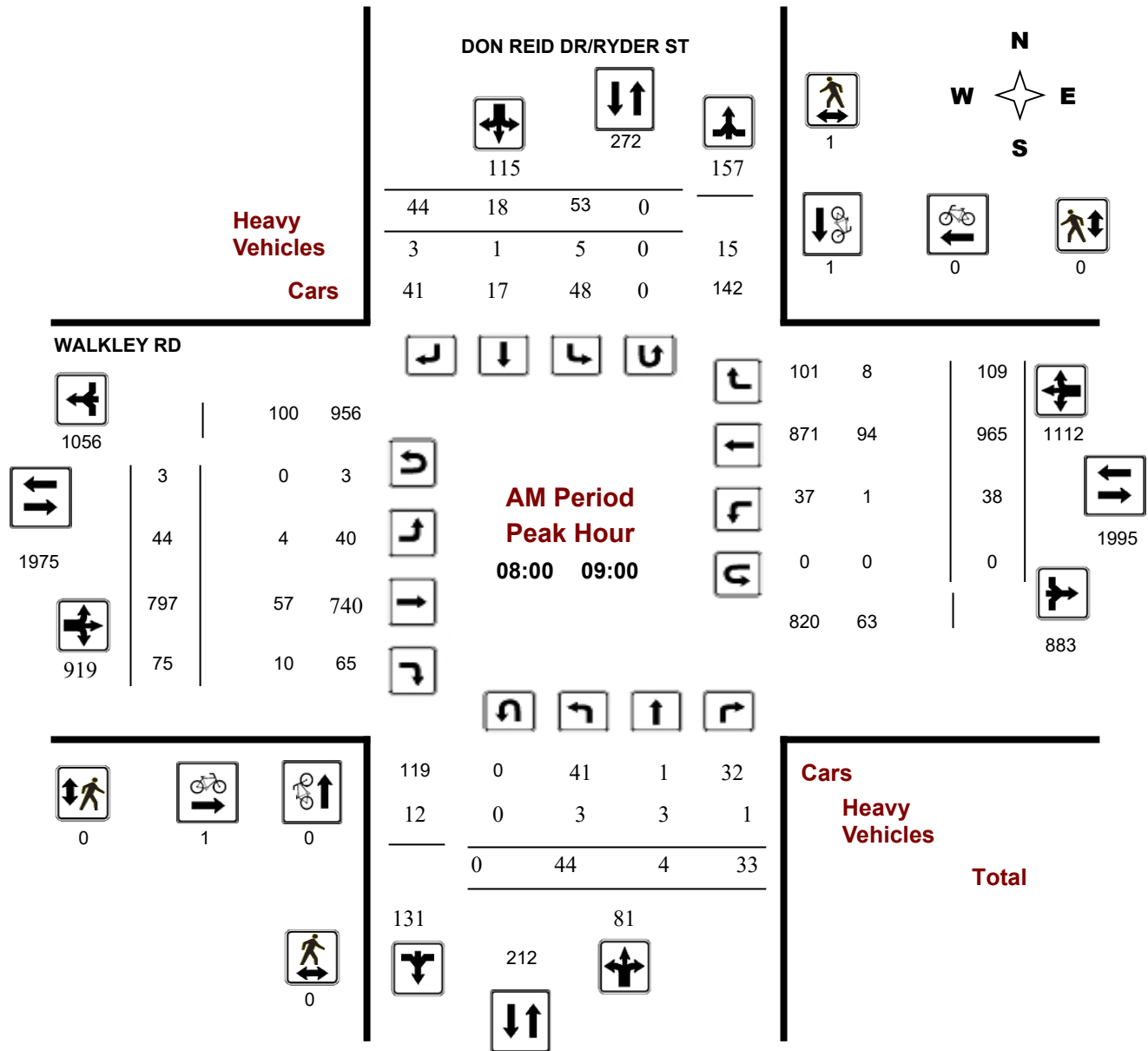

Turning Movement Count - Peak Hour Diagram

WALKLEY RD @ DON REID DR/Ryder ST

Survey Date: Thursday, January 20, 2022

Start Time: 07:00

WO No: 40069

Device: Miovision

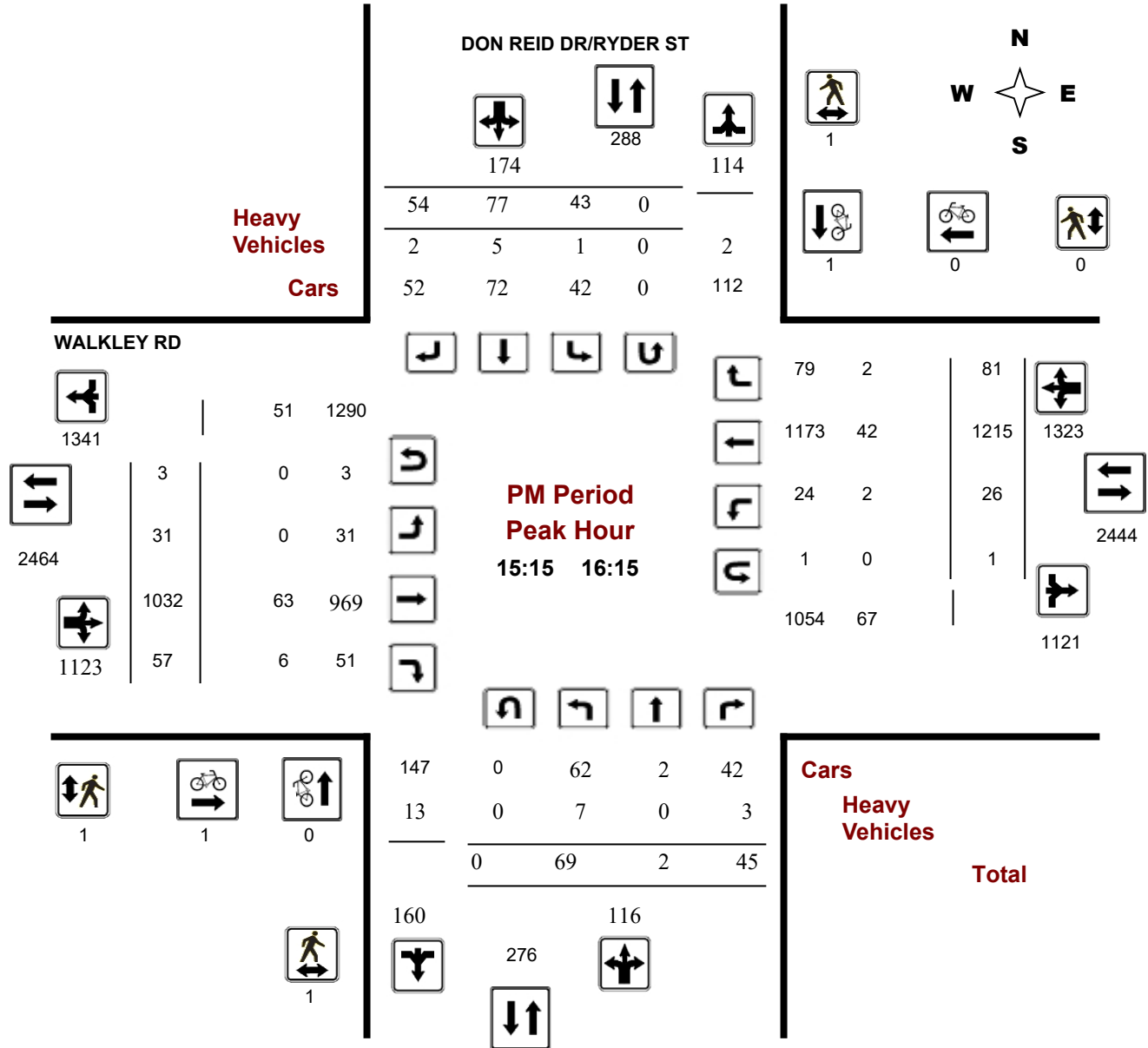

Comments



Transportation Services - Traffic Services

Turning Movement Count - Study Results WALKLEY RD @ DON REID DR/Ryder ST

Survey Date: Thursday, January 20, 2022

WO No: 40069

Start Time: 07:00

Device: Miovision

Full Study Summary (8 HR Standard)

Survey Date: Thursday, January 20, 2022

Total Observed U-Turns

AADT Factor

Northbound: 1 Southbound: 0
Eastbound: 15 Westbound: 6

1.00

DON REID DR/Ryder ST

WALKLEY RD

Period	Northbound					Southbound					Eastbound					Westbound			STR TOT	Grand Total
	LT	ST	RT	NB TOT	LT	ST	RT	SB TOT	STR TOT	LT	ST	RT	EB TOT	LT	ST	RT	WB TOT			
07:00 08:00	31	0	22	53	31	17	19	67	120	31	604	83	718	54	704	73	831	1549	1669	
08:00 09:00	44	4	33	81	53	18	44	115	196	44	797	75	916	38	965	109	1112	2028	2224	
09:00 10:00	43	2	38	83	46	22	35	103	186	27	703	54	784	36	731	57	824	1608	1794	
11:30 12:30	66	0	51	117	41	13	32	86	203	20	823	70	913	17	884	54	955	1868	2071	
12:30 13:30	37	1	37	75	46	14	31	91	166	20	799	61	880	27	819	55	901	1781	1947	
15:00 16:00	62	1	45	108	46	67	50	163	271	27	1026	55	1108	27	1135	84	1246	2354	2625	
16:00 17:00	92	3	56	151	54	52	51	157	308	26	1035	64	1125	15	1169	47	1231	2356	2664	
17:00 18:00	60	2	59	121	45	22	34	101	222	30	893	44	967	16	964	62	1042	2009	2231	
Sub Total	435	13	341	789	362	225	296	883	1672	225	6680	506	7411	230	7371	541	8142	15553	17225	
U Turns	1			1	0			0	1	15			15	6			6	21	22	
Total	436	13	341	790	362	225	296	883	1673	240	6680	506	7426	236	7371	541	8148	15574	17247	

EQ 12Hr 606 18 474 **1098** 503 313 411 **1227** **2325** 334 9285 703 **10322** 328 10246 752 **11326** **21648** **23973**

Note: These values are calculated by multiplying the totals by the appropriate expansion factor.

1.39

AVG 12Hr 606 18 474 **1098** 503 313 411 **1227** **2325** 334 9285 703 **10322** 328 10246 752 **11326** **21648** **23973**

Note: These volumes are calculated by multiplying the Equivalent 12 hr. totals by the AADT factor.

1.00

AVG 24Hr 794 24 621 **1439** 659 410 538 **1607** **3046** 438 12163 921 **13522** 430 13422 985 **14837** **28359** **31405**

Note: These volumes are calculated by multiplying the Average Daily 12 hr. totals by 12 to 24 expansion factor.

1.31

Note: U-Turns provided for approach totals. Refer to 'U-Turn' Report for specific breakdown.

Turning Movement Count - Peak Hour Diagram

WALKLEY RD @ 160 W OF CONROY RD

Survey Date: Tuesday, January 08, 2019

Start Time: 07:00

WO No: 38229

Device: Miovision

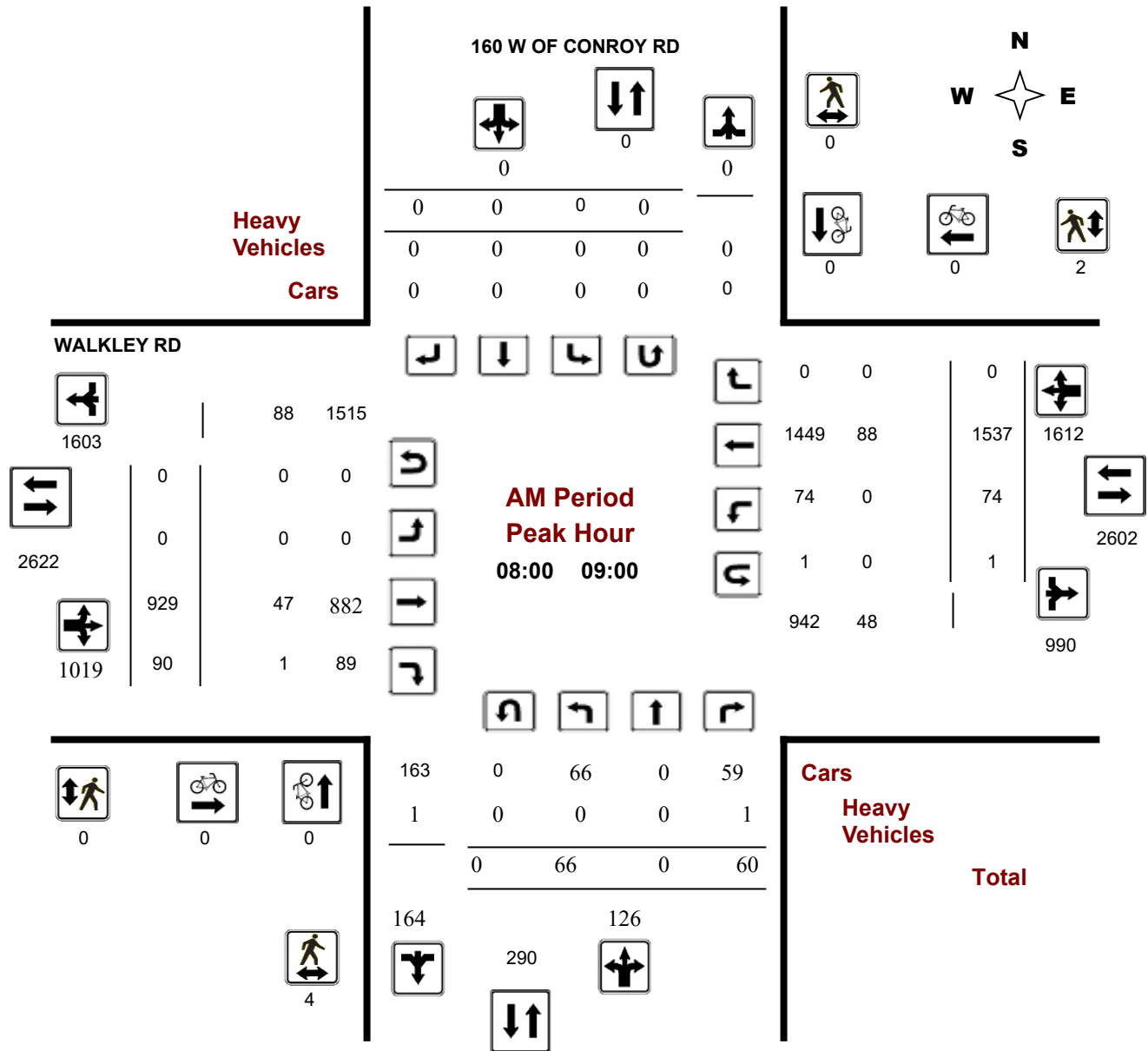

Turning Movement Count - Peak Hour Diagram

WALKLEY RD @ 160 W OF CONROY RD

Survey Date: Tuesday, January 08, 2019

Start Time: 07:00

WO No: 38229

Device: Miovision

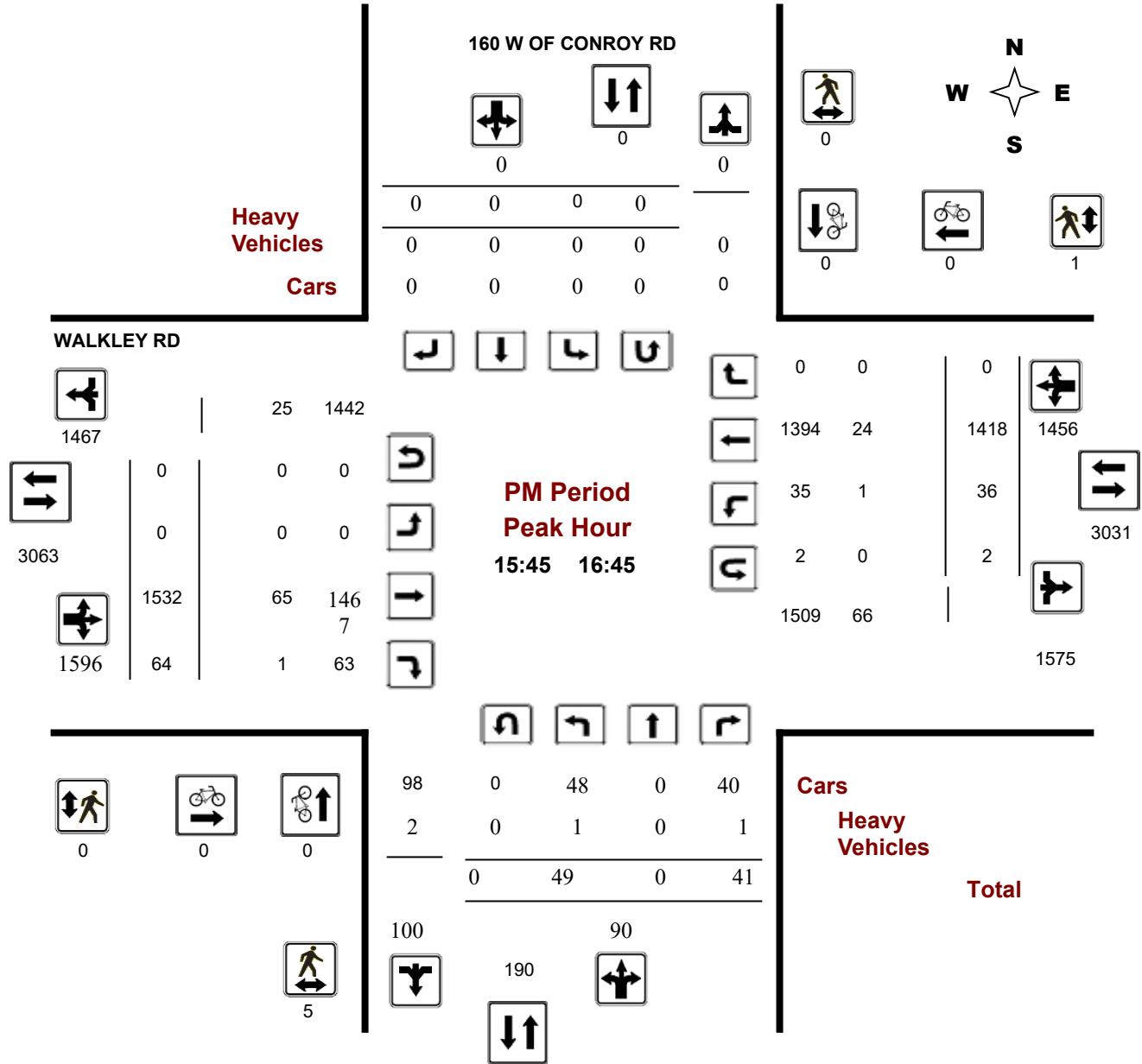



Transportation Services - Traffic Services

Turning Movement Count - Study Results

WALKLEY RD @ 160 W OF CONROY RD

Survey Date: Tuesday, January 08, 2019

WO No: 38229

Start Time: 07:00

Device: Miovision

Full Study Summary (8 HR Standard)

Survey Date: Tuesday, January 08, 2019

Total Observed U-Turns

AADT Factor

Northbound: 0 Southbound: 0
 Eastbound: 0 Westbound: 12

1.10

160 W OF CONROY RD

WALKLEY RD

Period	Northbound					Southbound					Eastbound					Westbound					Grand Total
	LT	ST	RT	NB TOT	STR TOT	LT	ST	RT	SB TOT	STR TOT	LT	ST	RT	EB TOT	STR TOT	LT	ST	RT	WB TOT	STR TOT	
07:00 08:00	59	0	53	112	112	0	0	0	0	112	0	771	82	853	853	73	1285	0	1358	2211	2323
08:00 09:00	66	0	60	126	126	0	0	0	0	126	0	929	90	1019	1019	74	1537	0	1611	2630	2756
09:00 10:00	51	0	43	94	94	0	0	0	0	94	0	800	67	867	867	71	988	0	1059	1926	2020
11:30 12:30	66	0	50	116	116	0	0	0	0	116	0	871	114	985	985	98	1033	0	1131	2116	2232
12:30 13:30	52	0	53	105	105	0	0	0	0	105	0	908	98	1006	1006	53	923	0	976	1982	2087
15:00 16:00	52	0	47	99	99	0	0	0	0	99	0	1376	71	1447	1447	56	1351	0	1407	2854	2953
16:00 17:00	49	0	47	96	96	0	0	0	0	96	0	1536	65	1601	1601	32	1371	0	1403	3004	3100
17:00 18:00	59	0	35	94	94	0	0	0	0	94	0	1219	73	1292	1292	54	1245	0	1299	2591	2685
Sub Total	454	0	388	842	842	0	0	0	0	842	0	8410	660	9070	9070	511	9733	0	10244	19314	20156
U Turns	0			0	0	0			0	0	0			0	0	12			12	12	12
Total	454	0	388	842	842	0	0	0	0	842	0	8410	660	9070	9070	523	9733	0	10256	19326	20168

EQ 12Hr 631 0 539 1170 0 0 0 0 1170 1170 0 11690 917 12607 12607 727 13529 0 14256 26863 28033

Note: These values are calculated by multiplying the totals by the appropriate expansion factor. **1.39**

AVG 12Hr 694 0 593 1287 0 0 0 0 1287 1287 0 12859 1009 13868 13868 800 14882 0 15682 29550 30837

Note: These volumes are calculated by multiplying the Equivalent 12 hr. totals by the AADT factor. **1.10**

AVG 24Hr 909 0 777 1686 0 0 0 0 1686 1686 0 16845 1322 18167 18167 1048 19495 0 20543 38710 40396

Note: These volumes are calculated by multiplying the Average Daily 12 hr. totals by 12 to 24 expansion factor. **1.31**

Note: U-Turns provided for approach totals. Refer to 'U-Turn' Report for specific breakdown.



Transportation Services - Traffic Services

Turning Movement Count - Peak Hour Diagram

CONROY RD @ WALKLEY RD

Survey Date: Thursday, February 22, 2018

Start Time: 07:00

WO No: 37565

Device: Miovision

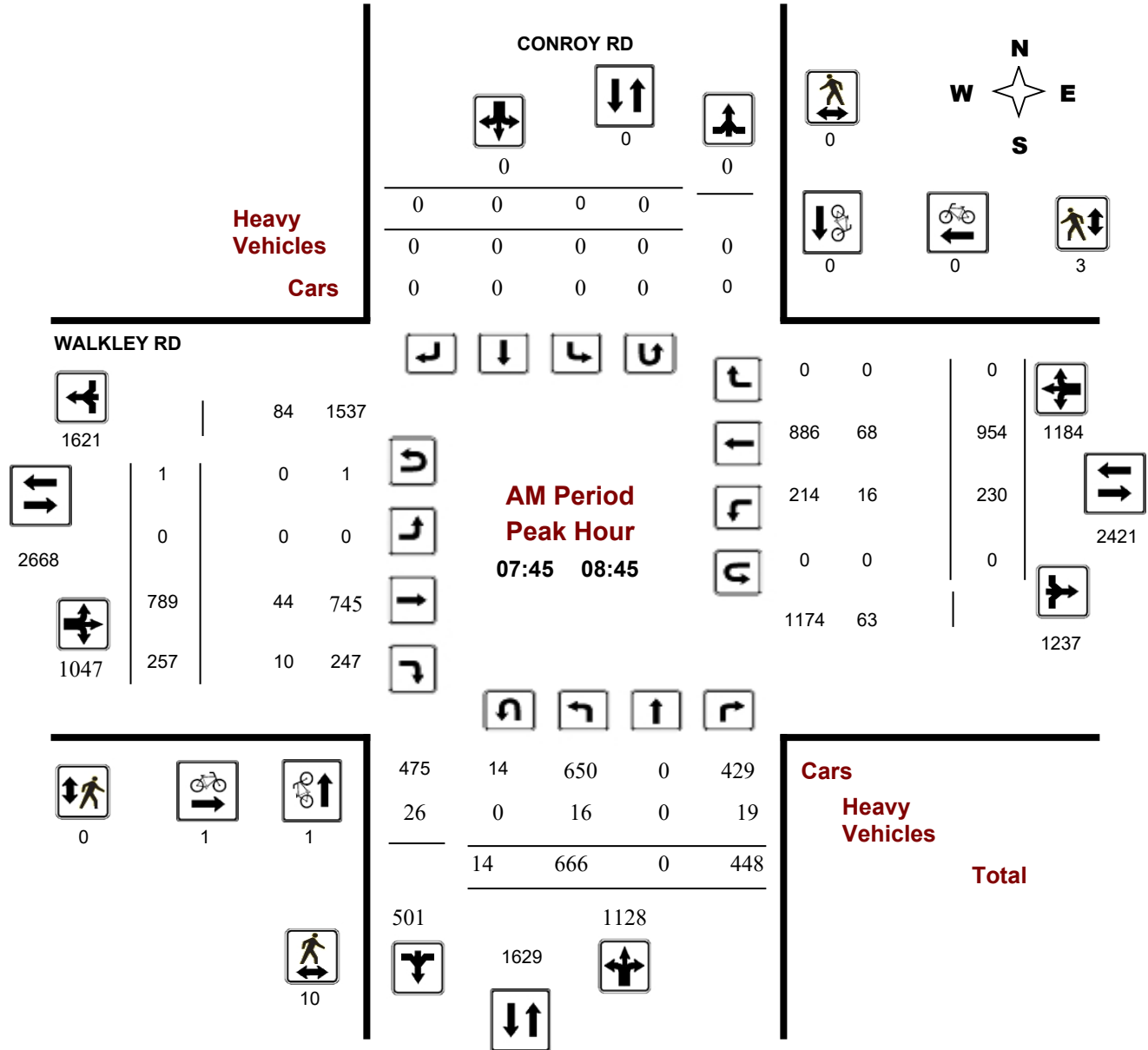

Turning Movement Count - Peak Hour Diagram

CONROY RD @ WALKLEY RD

Survey Date: Thursday, February 22, 2018

Start Time: 07:00

WO No: 37565

Device: Miovision

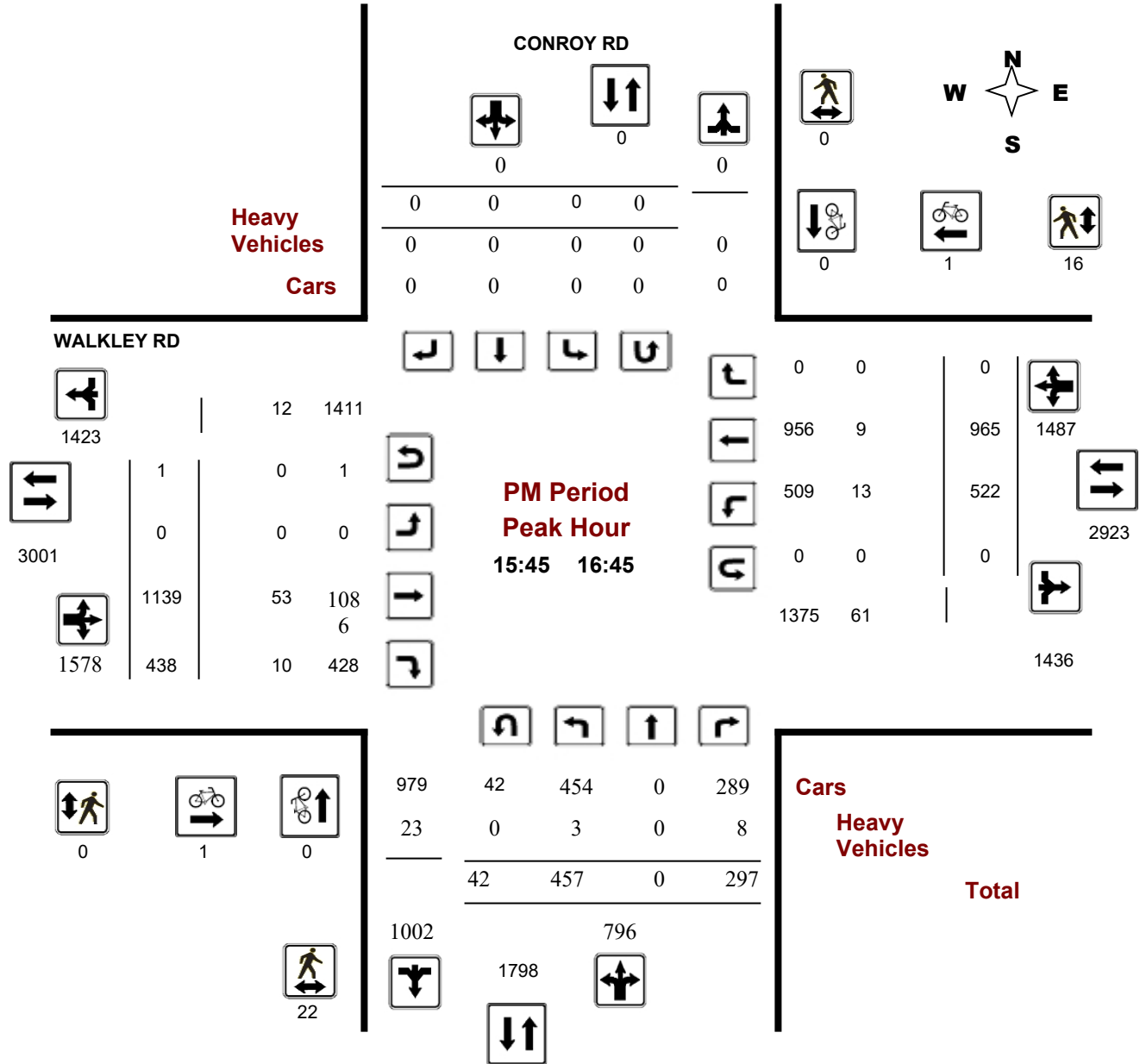



Turning Movement Count - Full Study Summary Report

CONROY RD @ WALKLEY RD

Survey Date: Thursday, February 22, 2018

Total Observed U-Turns

Northbound: 187 Southbound: 0
Eastbound: 4 Westbound: 3

AADT Factor

.90

Full Study

Period	CONROY RD									WALKLEY RD									Grand Total
	Northbound				Southbound					Eastbound			Westbound						
	LT	ST	RT	NB TOT	LT	ST	RT	SB TOT	STR TOT	LT	ST	RT	EB TOT	LT	ST	RT	WB TOT	STR TOT	
07:00 08:00	585	0	379	964	0	0	0	0	964	0	668	174	842	182	895	0	1077	1919	2883
08:00 09:00	641	0	476	1117	0	0	0	0	1117	0	791	257	1048	239	904	0	1143	2191	3308
09:00 10:00	378	0	317	695	0	0	0	0	695	0	671	209	880	227	736	0	963	1843	2538
11:30 12:30	400	0	243	643	0	0	0	0	643	0	798	252	1050	262	740	0	1002	2052	2695
12:30 13:30	342	0	259	601	0	0	0	0	601	0	793	302	1095	241	735	0	976	2071	2672
15:00 16:00	436	0	328	764	0	0	0	0	764	0	1028	360	1388	453	976	0	1429	2817	3581
16:00 17:00	443	0	292	735	0	0	0	0	735	0	1120	419	1539	504	986	0	1490	3029	3764
17:00 18:00	431	0	264	695	0	0	0	0	695	0	945	439	1384	416	824	0	1240	2624	3319
Sub Total	3656	0	2558	6214	0	0	0	0	6214	0	6814	2412	9226	2524	6796	0	9320	18546	24760
U Turns				187				0	187				4				3	7	194
Total	3656	0	2558	6401	0	0	0	0	6401	0	6814	2412	9230	2524	6796	0	9323	18553	24954
EQ 12Hr	5082	0	3556	8897	0	0	0	0	8897	0	9471	3353	12830	3508	9446	0	12959	25789	34686
Note: These values are calculated by multiplying the totals by the appropriate expansion factor.													1.39						
AVG 12Hr	4574	0	3200	8008	0	0	0	0	8008	0	8524	3017	11547	3158	8502	0	11663	23210	31218
Note: These volumes are calculated by multiplying the Equivalent 12 hr. totals by the AADT factor.													.90						
AVG 24Hr	5991	0	4192	10490	0	0	0	0	10490	0	11167	3953	15126	4136	11137	0	15279	30405	40895
Note: These volumes are calculated by multiplying the Average Daily 12 hr. totals by 12 to 24 expansion factor.													1.31						

Comments:

Note: U-Turns provided for approach totals. Refer to 'U-Turn' Report for specific breakdown.

Turning Movement Count - Peak Hour Diagram

CONROY RD @ ST. LAURENT BLVD

Survey Date: Thursday, June 01, 2017

Start Time: 07:00

WO No: 37032

Device: Miovision

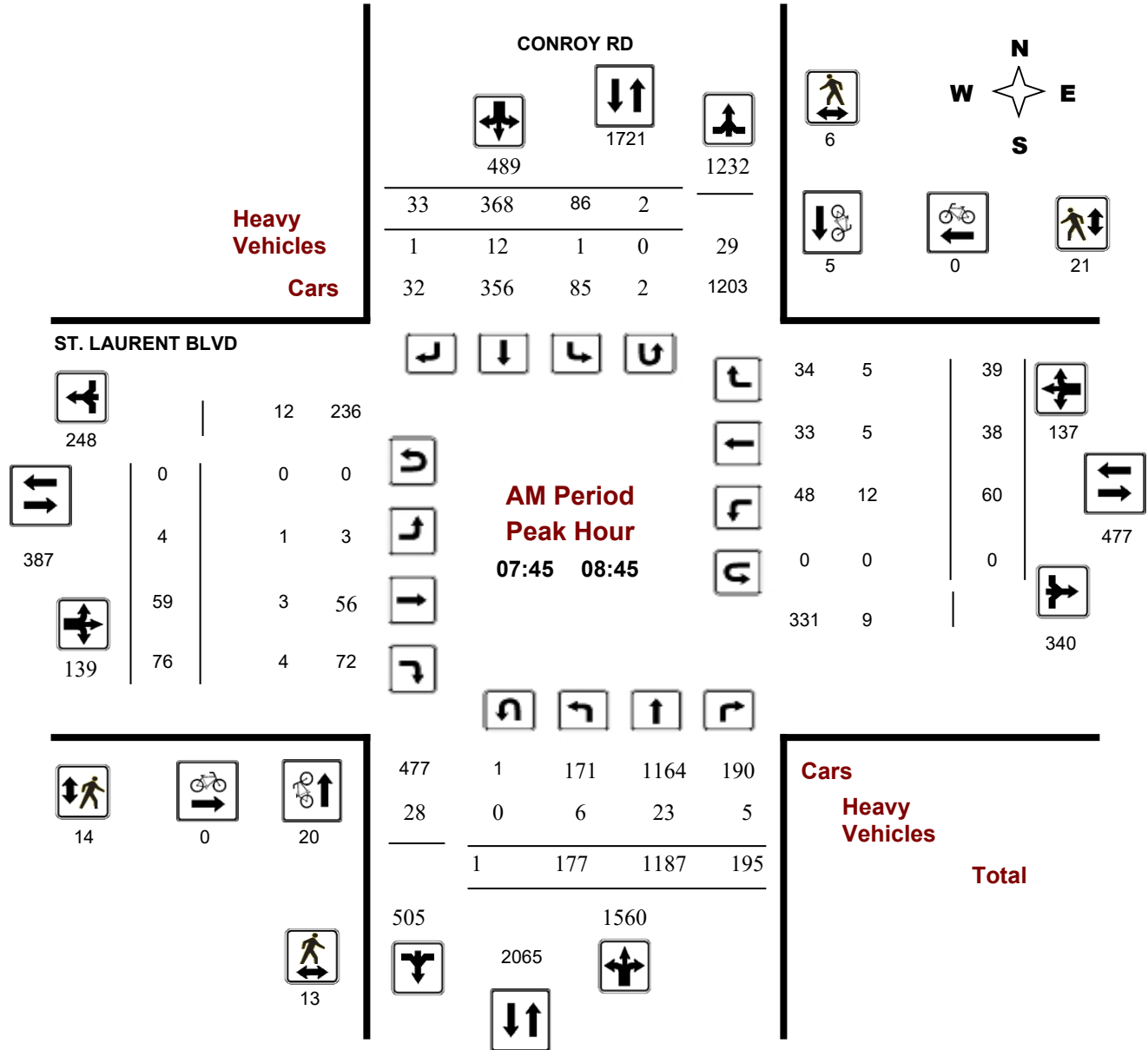

Turning Movement Count - Peak Hour Diagram

CONROY RD @ ST. LAURENT BLVD

Survey Date: Thursday, June 01, 2017

Start Time: 07:00

WO No: 37032

Device: Miovision

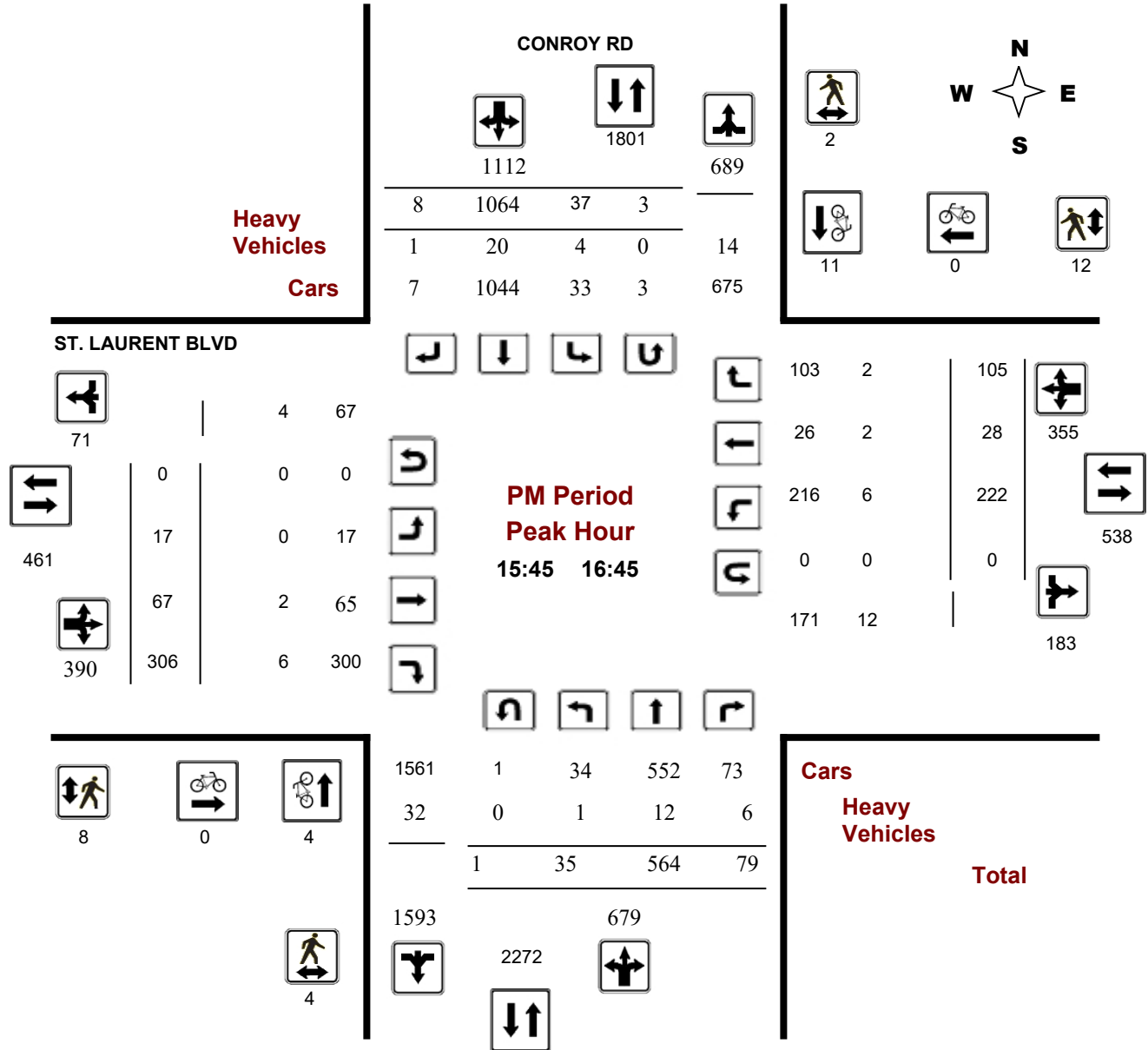

Turning Movement Count - Full Study Summary Report

CONROY RD @ ST. LAURENT BLVD

Survey Date: Thursday, June 01, 2017

Total Observed U-Turns

Northbound: 12 Southbound: 36
Eastbound: 0 Westbound: 0

AADT Factor

.90

Full Study

Period	CONROY RD									ST. LAURENT BLVD									Grand Total
	Northbound			NB TOT	Southbound			SB TOT	STR TOT	Eastbound			EB TOT	Westbound			WB TOT	STR TOT	
	LT	ST	RT		LT	ST	RT			LT	ST	RT		LT	ST	RT			
07:00 08:00	146	949	149	1244	88	327	33	448	1692	3	28	52	83	44	33	19	96	179	1871
08:00 09:00	153	1186	194	1533	81	387	29	497	2030	4	59	73	136	53	29	46	128	264	2294
09:00 10:00	71	646	114	831	66	427	21	514	1345	10	25	72	107	56	23	47	126	233	1578
11:30 12:30	47	554	70	671	72	521	23	616	1287	13	24	75	112	115	32	128	275	387	1674
12:30 13:30	59	572	113	744	121	522	31	674	1418	8	36	78	122	88	25	99	212	334	1752
15:00 16:00	44	671	68	783	43	873	13	929	1712	13	29	196	238	167	36	109	312	550	2262
16:00 17:00	32	568	76	676	39	1007	9	1055	1731	17	65	314	396	229	23	106	358	754	2485
17:00 18:00	22	598	70	690	54	929	5	988	1678	7	37	207	251	122	16	70	208	459	2137
Sub Total	574	5744	854	7172	564	4993	164	5721	12893	75	303	1067	1445	874	217	624	1715	3160	16053
U Turns				12				36	48				0				0	0	48
Total	574	5744	854	7184	564	4993	164	5757	12941	75	303	1067	1445	874	217	624	1715	3160	16101
EQ 12Hr	798	7984	1187	9986	784	6940	228	8002	17988	104	421	1483	2009	1215	302	867	2384	4393	22381
Note: These values are calculated by multiplying the totals by the appropriate expansion factor.													1.39						
AVG 12Hr	718	7186	1068	8987	706	6246	205	7202	16189	94	379	1335	1808	1093	271	781	2145	3953	20142
Note: These volumes are calculated by multiplying the Equivalent 12 hr. totals by the AADT factor.													.90						
AVG 24Hr	941	9413	1400	11773	924	8183	269	9435	21208	123	497	1749	2368	1432	356	1023	2811	5179	26387
Note: These volumes are calculated by multiplying the Average Daily 12 hr. totals by 12 to 24 expansion factor.													1.31						

Comments:

Note: U-Turns provided for approach totals. Refer to 'U-Turn' Report for specific breakdown.



Turning Movement Count Summary, AM and PM Peak Hour Flow Diagrams

All Vehicles Except Bicycles



Don Reid Drive & St. Laurent Boulevard

Ottawa, ON

All Vehicles
(Except Bicycles & Electric Scooters)

Wednesday, June 08, 2022

0700-1000, 1130-1330 & 1500-1800

8 Hour Survey

City of Ottawa Ward 10

St. Laurent Blvd.

Total vehicle volume,
all approaches.
(A + C + D)

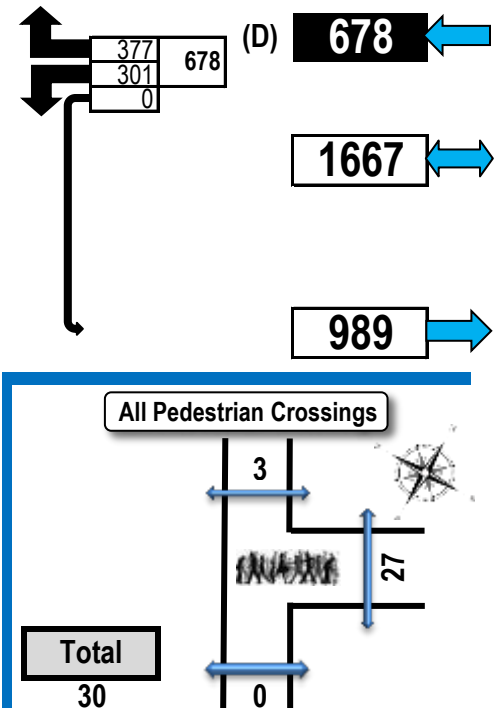
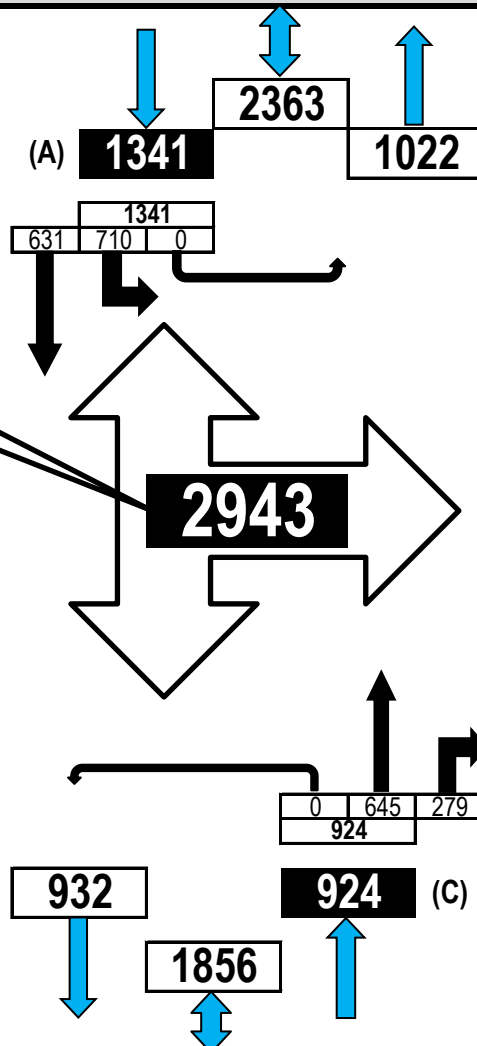

AM Peak Hour Flow Diagram

PM Peak Hour Flow Diagram

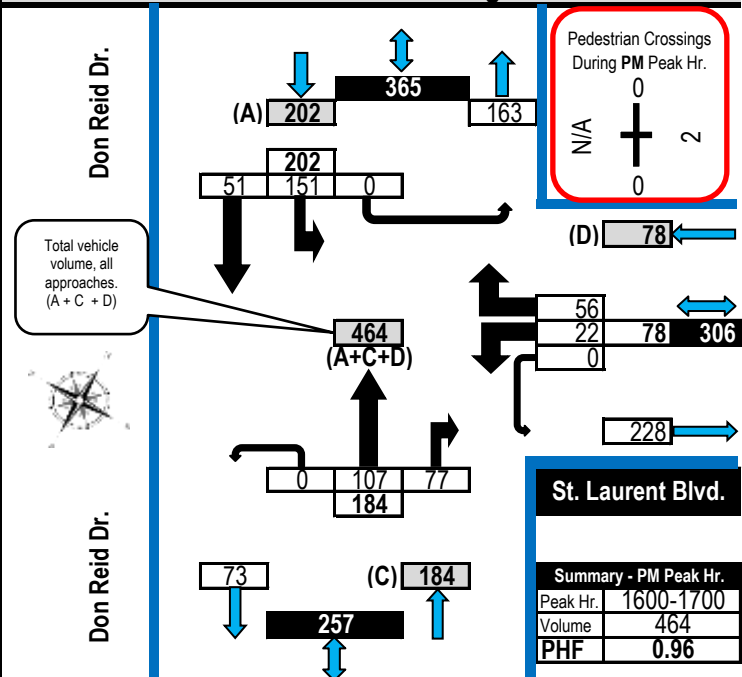
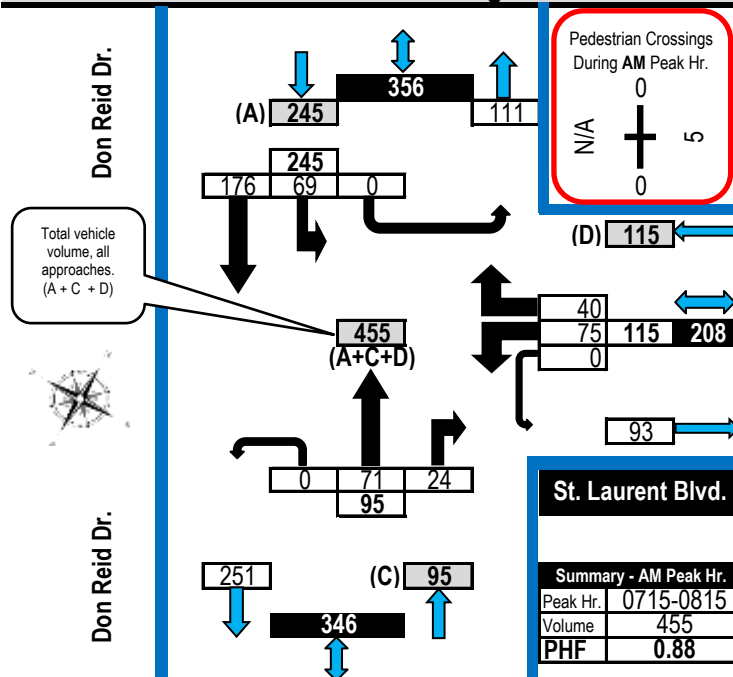



Turning Movement Count

Summary Report Including Peak Hours, AADT and Expansion Factors

All Vehicles Except Bicycles



Don Reid Drive & St. Laurent Boulevard Ottawa, ON

Survey Date: Wednesday, June 08, 2022 **Start Time:** 0700 **AADT Factor:** 0.9
Weather AM: Mostly Cloudy 16° C **Survey Duration:** 8 Hrs. **Survey Hours:** 0700-1000, 1130-1330 & 1500-1800
Weather PM: Mainly Cloudy 23° C **Surveyor(s):** J. Mousseau

Time Period	N/A					St. Laurent Blvd.					Don Reid Dr.					Don Reid Dr.					Street Total	Grand Total	
	Eastbound					Westbound					Northbound					Southbound							
	LT	ST	RT	UT	E/B Tot	LT	ST	RT	UT	W/B Tot	Street Total	LT	ST	RT	UT	N/B Tot	LT	ST	RT	UT	S/B Tot	Street Total	Grand Total
0700-0800						75		29	0	104	104		57	19	0	76	55	157		0	212	288	392
0800-0900						47		66	0	113	113		50	14	0	64	91	94		0	185	249	362
0900-1000						28		57	0	85	85		27	14	0	41	81	69		0	150	191	276
1130-1230						36		39	0	75	75		121	32	0	153	77	89		0	166	319	394
1230-1330						43		49	0	92	92		76	33	0	109	63	75		0	138	247	339
1500-1600						31		42	0	73	73		101	41	0	142	106	44		0	150	292	365
1600-1700						22		56	0	78	78		107	77	0	184	151	51		0	202	386	464
1700-1800						19		39	0	58	58		106	49	0	155	86	52		0	138	293	351
Totals						301		377	0	678	678		645	279	0	924	710	631		0	1341	2265	2943

Equivalent 12 & 24-hour Vehicle Volumes Including the Annual Average Daily Traffic (AADT) Factor
Applicable to the Day and Month of the Turning Movement Count

Expansion factors are applied exclusively to standard weekday 8-hour turning movement counts conducted during the hours of 0700h - 1000h, 1130h - 1330h and 1500h - 1800h

Equivalent 12-hour vehicle volumes. These volumes are calculated by multiplying the 8-hour totals by the 8 → 12 expansion factor of 1.39																							
Equ. 12 Hr	0	0	0	0	0	418	0	524	0	942	942	0	897	388	0	1284	987	877	0	0	1864	3148	4091

Average daily 12-hour vehicle volumes. These volumes are calculated by multiplying the equivalent 12-hour totals by the AADT factor of: 0.9																							
AADT 12-hr	0	0	0	0	0	377	0	472	0	848	848	0	807	349	0	1156	888	789	0	0	1678	2834	3682

24-Hour AADT. These volumes are calculated by multiplying the average daily 12-hour vehicle volumes by the 12 → 24 expansion factor of 1.31																							
AADT 24 Hr	0	0	0	0	0	493	0	618	0	1111	1111	0	1057	457	0	1514	1164	1034	0	0	2198	3712	4823

AADT and expansion factors provided by the City of Ottawa

AM Peak Hour Factor → 0.88											Highest Hourly Vehicle Volume Between 0700h & 1000h													
AM Peak Hr	LT	ST	RT	UT	Total	LT	ST	RT	UT	Total	Str. Tot.	LT	ST	RT	UT	Total	LT	ST	RT	UT	Total	Str. Tot.	Gr. Tot.	
0715-0815	0	0	0	0	0	75	0	40	0	115	115		0	71	24	0	95	69	176	0	0	245	340	455
OFF Peak Hour Factor → 0.84											Highest Hourly Vehicle Volume Between 1130h & 1330h													
OFF Peak Hr	LT	ST	RT	UT	Total	LT	ST	RT	UT	Total	Str. Tot.	LT	ST	RT	UT	Total	LT	ST	RT	UT	Total	Str. Tot.	Gr. Tot.	
1200-1300	0	0	0	0	0	45	0	54	0	99	99		0	120	37	0	157	71	85	0	0	156	313	412
PM Peak Hour Factor → 0.96											Highest Hourly Vehicle Volume Between 1500h & 1800h													
PM Peak Hr	LT	ST	RT	UT	Total	LT	ST	RT	UT	Total	Str. Tot.	LT	ST	RT	UT	Total	LT	ST	RT	UT	Total	Str. Tot.	Gr. Tot.	
1600-1700	0	0	0	0	0	22	0	56	0	78	78		0	107	77	0	184	151	51	0	0	202	386	464

Comments:

Buses and school buses comprise 7.94% of the heavy vehicle traffic. Ambulances comprise much of the heavy vehicle volume. The bicycle totals include 3 E-bikes.

Notes:

1. Includes all vehicle types except bicycles, electric bicycles, and electric scooters.
2. When expansion and AADT factors are applied, the results will differ slightly due to rounding.

APPENDIX E

Collision Records



Transportation Services - Traffic Services

Collision Details Report - Public Version

From: January 1, 2016 To: December 31, 2020

Location: CONROY RD @ ST. LAURENT BLVD

Traffic Control: Traffic signal

Total Collisions: 22

Date/Day/Time	Environment	Impact Type	Classification	Surface Cond'n	Veh. Dir	Vehicle Manoeuver	Vehicle type	First Event	No. Ped
2016-Jun-20, Mon,09:52	Clear	Rear end	P.D. only	Dry	South	Going ahead	Pick-up truck	Other motor vehicle	0
					South	Stopped	Automobile, station wagon	Other motor vehicle	
2016-Jul-18, Mon,18:21	Clear	Rear end	Non-fatal injury	Dry	South	Turning left	Automobile, station wagon	Other motor vehicle	0
					South	Turning left	Automobile, station wagon	Other motor vehicle	
2016-Aug-12, Fri,21:35	Rain	Rear end	P.D. only	Wet	West	Turning left	Automobile, station wagon	Other motor vehicle	0
					West	Turning left	Automobile, station wagon	Other motor vehicle	
2016-Oct-21, Fri,13:22	Rain	Angle	Non-fatal injury	Wet	West	Going ahead	Pick-up truck	Other motor vehicle	0
					South	Going ahead	Automobile, station wagon	Other motor vehicle	
2016-Nov-11, Fri,18:04	Clear	Turning movement	P.D. only	Dry	North	Turning left	Unknown	Other motor vehicle	0
					South	Going ahead	Passenger van	Other motor vehicle	
2016-Nov-11, Fri,18:45	Clear	Angle	P.D. only	Dry	West	Going ahead	Passenger van	Other motor vehicle	0
					North	Going ahead	Automobile, station wagon	Other motor vehicle	
2016-Nov-18, Fri,14:35	Clear	Angle	Non-fatal injury	Dry	North	Going ahead	Passenger van	Other motor vehicle	0
					West	Going ahead	Automobile, station wagon	Other motor vehicle	
2017-Jan-17, Tue,15:30	Clear	Rear end	P.D. only	Dry	South	Going ahead	Automobile, station wagon	Other motor vehicle	0
					South	Going ahead	Pick-up truck	Other motor vehicle	
2017-Feb-05, Sun,21:15	Snow	Sideswipe	P.D. only	Loose snow	South	Slowing or stopping	Pick-up truck	Other motor vehicle	0
					South	Stopped	Passenger van	Other motor vehicle	
2017-May-03, Wed,19:07	Clear	Angle	P.D. only	Dry	West	Turning right	Automobile, station wagon	Other motor vehicle	0
					North	Going ahead	Automobile, station wagon	Other motor vehicle	
2017-Jun-18, Sun,11:10	Clear	Sideswipe	Non-fatal injury	Dry	South	Unknown	Unknown	Other motor vehicle	0
					South	Going ahead	Automobile, station wagon	Other motor vehicle	
2017-Jul-26, Wed,13:14	Clear	Rear end	P.D. only	Dry	North	Going ahead	Automobile, station wagon	Other motor vehicle	0
					North	Stopped	Automobile, station wagon	Other motor vehicle	



Transportation Services - Traffic Services

Collision Details Report - Public Version

From: January 1, 2016 To: December 31, 2020

Location: CONROY RD @ ST. LAURENT BLVD

Traffic Control: Traffic signal

Total Collisions: 22

Date/Day/Time	Environment	Impact Type	Classification	Surface Cond'n	Veh. Dir	Vehicle Manoeuver	Vehicle type	First Event	No. Ped
2017-Jul-26, Wed,14:49	Clear	Angle	P.D. only	Dry	North	Going ahead	Automobile, station wagon	Other motor vehicle	0
					West	Going ahead	Automobile, station wagon	Other motor vehicle	
2017-Aug-11, Fri,13:18	Clear	Rear end	P.D. only	Dry	West	Going ahead	Automobile, station wagon	Other motor vehicle	0
					West	Slowing or stopping	Automobile, station wagon	Other motor vehicle	
2017-Nov-21, Tue,13:45	Clear	Sideswipe	P.D. only	Dry	North	Changing lanes	School van	Other motor vehicle	0
					North	Stopped	Automobile, station wagon	Other motor vehicle	
2018-Jan-08, Mon,10:34	Snow	Angle	P.D. only	Loose snow	South	Going ahead	Police vehicle	Skidding/sliding	0
					West	Turning left	Automobile, station wagon	Other motor vehicle	
2018-May-03, Thu,07:24	Clear	Angle	P.D. only	Dry	North	Going ahead	Automobile, station wagon	Other motor vehicle	0
					West	Going ahead	Automobile, station wagon	Other motor vehicle	
2018-Oct-09, Tue,07:06	Fog, mist, smoke, Turning movement dust	Turning movement	Non-fatal injury	Wet	South	Turning left	Automobile, station wagon	Other motor vehicle	0
					North	Going ahead	Automobile, station wagon	Other motor vehicle	
2019-Mar-29, Fri,15:30	Clear	Rear end	P.D. only	Dry	East	Turning right	Automobile, station wagon	Other motor vehicle	0
					East	Turning right	Automobile, station wagon	Other motor vehicle	
2019-Jun-11, Tue,10:44	Clear	Rear end	P.D. only	Dry	North	Going ahead	Delivery van	Other motor vehicle	0
					North	Stopped	Automobile, station wagon	Other motor vehicle	
2019-Sep-06, Fri,14:40	Clear	Rear end	P.D. only	Dry	East	Turning right	Automobile, station wagon	Other motor vehicle	0
					East	Turning right	Automobile, station wagon	Other motor vehicle	
2020-Nov-11, Wed,13:16	Clear	Rear end	P.D. only	Dry	East	Turning right	Unknown	Other motor vehicle	0
					East	Turning right	Automobile, station wagon	Other motor vehicle	

Location: CONROY RD @ WALKLEY RD

Traffic Control: Traffic signal

Total Collisions: 74

Date/Day/Time	Environment	Impact Type	Classification	Surface Cond'n	Veh. Dir	Vehicle Manoeuver	Vehicle type	First Event	No. Ped
---------------	-------------	-------------	----------------	----------------	----------	-------------------	--------------	-------------	---------



Transportation Services - Traffic Services

Collision Details Report - Public Version

From: January 1, 2016 To: December 31, 2020

Location: CONROY RD @ WALKLEY RD

Traffic Control: Traffic signal

Total Collisions: 74

Date/Day/Time	Environment	Impact Type	Classification	Surface Cond'n	Veh. Dir	Vehicle Manoeuvre	Vehicle type	First Event	No. Ped
2016-Jan-17, Sun,16:20	Snow	Rear end	P.D. only	Loose snow	North	Turning right	Pick-up truck	Other motor vehicle	0
					North	Turning right	Pick-up truck	Other motor vehicle	
2016-Feb-09, Tue,10:45	Snow	Rear end	P.D. only	Loose snow	North	Slowing or stopping	Pick-up truck	Other motor vehicle	0
					North	Slowing or stopping	Automobile, station wagon	Other motor vehicle	
2016-Feb-16, Tue,13:00	Snow	Rear end	P.D. only	Packed snow	West	Slowing or stopping	Pick-up truck	Other motor vehicle	0
					West	Stopped	Passenger van	Other motor vehicle	
2016-Feb-19, Fri,08:40	Clear	Rear end	P.D. only	Ice	West	Slowing or stopping	Automobile, station wagon	Other motor vehicle	0
					West	Stopped	Pick-up truck	Other motor vehicle	
2016-Feb-23, Tue,12:31	Clear	Rear end	P.D. only	Dry	East	Turning right	Automobile, station wagon	Other motor vehicle	0
					East	Turning right	Automobile, station wagon	Other motor vehicle	
2016-Mar-10, Thu,15:54	Clear	Rear end	Non-fatal injury	Wet	West	Going ahead	Truck - tank	Other motor vehicle	0
					West	Slowing or stopping	Automobile, station wagon	Other motor vehicle	
2016-Mar-29, Tue,18:15	Clear	Sideswipe	P.D. only	Dry	North	Turning left	Unknown	Other motor vehicle	0
					North	Turning left	Pick-up truck	Other motor vehicle	
2016-Apr-02, Sat,13:38	Clear	Rear end	P.D. only	Wet	North	Turning right	Automobile, station wagon	Other motor vehicle	0
					North	Turning right	Pick-up truck	Other motor vehicle	
2016-Apr-19, Tue,16:43	Clear	Rear end	P.D. only	Dry	West	Going ahead	Passenger van	Other motor vehicle	0
					West	Slowing or stopping	Automobile, station wagon	Other motor vehicle	
					West	Going ahead	Automobile, station wagon	Other motor vehicle	
2016-Jun-02, Thu,18:38	Clear	Turning movement	P.D. only	Dry	West	Turning left	Automobile, station wagon	Other motor vehicle	0
					East	Going ahead	Automobile, station wagon	Other motor vehicle	
2016-Jul-18, Mon,15:58	Clear	Turning movement	Non-fatal injury	Dry	West	Turning left	Police vehicle	Other motor vehicle	0
					East	Going ahead	Automobile, station wagon	Other motor vehicle	



Transportation Services - Traffic Services

Collision Details Report - Public Version

From: January 1, 2016 To: December 31, 2020

Location: CONROY RD @ WALKLEY RD

Traffic Control: Traffic signal

Total Collisions: 74

Date/Day/Time	Environment	Impact Type	Classification	Surface Cond'n	Veh. Dir	Vehicle Manoeuvre	Vehicle type	First Event	No. Ped
2016-Jul-22, Fri,08:50	Clear	Turning movement	P.D. only	Dry	West	Turning left	Automobile, station wagon	Other motor vehicle	0
					East	Going ahead	Automobile, station wagon	Other motor vehicle	
2016-Sep-26, Mon,15:48	Clear	Rear end	P.D. only	Dry	West	Turning left	Automobile, station wagon	Other motor vehicle	0
					West	Turning left	Automobile, station wagon	Other motor vehicle	
2016-Oct-11, Tue,01:58	Clear	Sideswipe	P.D. only	Dry	North	Overtaking	Automobile, station wagon	Other motor vehicle	0
					North	Turning right	Pick-up truck	Other motor vehicle	
2016-Oct-27, Thu,17:45	Snow	Rear end	P.D. only	Wet	East	Slowing or stopping	Automobile, station wagon	Other motor vehicle	0
					East	Stopped	Automobile, station wagon	Other motor vehicle	
2016-Nov-04, Fri,17:07	Clear	Rear end	Non-fatal injury	Dry	West	Going ahead	Pick-up truck	Other motor vehicle	0
					West	Stopped	Automobile, station wagon	Other motor vehicle	
2016-Dec-06, Tue,10:30	Clear	Sideswipe	P.D. only	Wet	West	Changing lanes	Pick-up truck	Other motor vehicle	0
					West	Turning left	Tow truck	Other motor vehicle	
2016-Dec-07, Wed,07:35	Snow	Rear end	P.D. only	Slush	North	Going ahead	Automobile, station wagon	Other motor vehicle	0
					North	Stopped	Automobile, station wagon	Other motor vehicle	
					North	Stopped	Automobile, station wagon	Other motor vehicle	
2016-Dec-19, Mon,06:27	Clear	Angle	P.D. only	Packed snow	East	Going ahead	Automobile, station wagon	Other motor vehicle	0
					North	Turning left	Automobile, station wagon	Other motor vehicle	
2017-Jan-26, Thu,10:41	Snow	Rear end	P.D. only	Wet	East	Slowing or stopping	Automobile, station wagon	Other motor vehicle	0
					East	Stopped	Automobile, station wagon	Other motor vehicle	
2017-Apr-25, Tue,08:16	Clear	Rear end	P.D. only	Dry	North	Turning right	Automobile, station wagon	Other motor vehicle	0
					North	Turning right	Pick-up truck	Other motor vehicle	
2017-May-11, Thu,16:15	Clear	Sideswipe	P.D. only	Dry	West	Changing lanes	Pick-up truck	Other motor vehicle	0
					West	Going ahead	Passenger van	Other motor vehicle	



Transportation Services - Traffic Services

Collision Details Report - Public Version

From: January 1, 2016 To: December 31, 2020

Location: CONROY RD @ WALKLEY RD

Traffic Control: Traffic signal

Total Collisions: 74

Date/Day/Time	Environment	Impact Type	Classification	Surface Cond'n	Veh. Dir	Vehicle Manoeuvre	Vehicle type	First Event	No. Ped
2017-Jun-04, Sun,19:14	Clear	Rear end	P.D. only	Dry	East	Going ahead	Automobile, station wagon	Other motor vehicle	0
					East	Stopped	Automobile, station wagon	Other motor vehicle	
2017-Jun-12, Mon,19:30	Clear	Rear end	P.D. only	Dry	East	Unknown	Unknown	Other motor vehicle	0
					East	Stopped	Automobile, station wagon	Other motor vehicle	
2017-Jun-15, Thu,18:43	Clear	Rear end	Non-fatal injury	Dry	East	Going ahead	Passenger van	Other motor vehicle	0
					East	Stopped	Automobile, station wagon	Other motor vehicle	
2017-Jun-22, Thu,17:14	Clear	Sideswipe	P.D. only	Dry	East	Changing lanes	Passenger van	Other motor vehicle	0
					East	Turning right	Automobile, station wagon	Other motor vehicle	
2017-Jul-06, Thu,16:25	Clear	Rear end	P.D. only	Dry	North	Turning right	Automobile, station wagon	Other motor vehicle	0
					North	Turning right	Automobile, station wagon	Other motor vehicle	
2017-Sep-05, Tue,08:21	Clear	Rear end	Non-fatal injury	Wet	North	Going ahead	Automobile, station wagon	Other motor vehicle	0
					North	Stopped	Automobile, station wagon	Other motor vehicle	
2017-Sep-26, Tue,13:25	Clear	Rear end	P.D. only	Dry	North	Turning right	Automobile, station wagon	Other motor vehicle	0
					North	Turning right	Automobile, station wagon	Other motor vehicle	
2017-Oct-11, Wed,16:09	Clear	Rear end	P.D. only	Dry	North	Going ahead	Passenger van	Other motor vehicle	0
					North	Turning right	Automobile, station wagon	Other motor vehicle	
2017-Nov-08, Wed,15:15	Clear	Rear end	P.D. only	Dry	East	Turning right	Pick-up truck	Other motor vehicle	0
					East	Turning right	Pick-up truck	Other motor vehicle	
2017-Dec-23, Sat,14:25	Snow	Rear end	P.D. only	Loose snow	East	Slowing or stopping	Automobile, station wagon	Other motor vehicle	0
					East	Stopped	Automobile, station wagon	Other motor vehicle	
2018-Jan-09, Tue,17:40	Clear	Rear end	P.D. only	Slush	East	Going ahead	Automobile, station wagon	Other motor vehicle	0
					East	Slowing or stopping	Automobile, station wagon	Other motor vehicle	
2018-Jan-26, Fri,12:20	Clear	Sideswipe	P.D. only	Dry	West	Changing lanes	Automobile, station wagon	Other motor vehicle	0
					West	Going ahead	Automobile, station wagon	Other motor vehicle	



Transportation Services - Traffic Services

Collision Details Report - Public Version

From: January 1, 2016 To: December 31, 2020

Location: CONROY RD @ WALKLEY RD

Traffic Control: Traffic signal

Total Collisions: 74

Date/Day/Time	Environment	Impact Type	Classification	Surface Cond'n	Veh. Dir	Vehicle Manoeuvre	Vehicle type	First Event	No. Ped
2018-Feb-11, Sun,14:18	Rain	Turning movement	P.D. only	Wet	East	Going ahead	Automobile, station wagon	Other motor vehicle	0
					West	Turning left	Automobile, station wagon	Other motor vehicle	
2018-Feb-14, Wed,09:31	Clear	Rear end	P.D. only	Wet	West	Going ahead	Automobile, station wagon	Skidding/sliding	0
					West	Stopped	Automobile, station wagon	Other motor vehicle	
2018-Apr-23, Mon,16:31	Clear	Rear end	P.D. only	Dry	East	Going ahead	Passenger van	Other motor vehicle	0
					East	Stopped	Automobile, station wagon	Other motor vehicle	
2018-May-15, Tue,08:56	Clear	Sideswipe	P.D. only	Dry	West	Changing lanes	Pick-up truck	Other motor vehicle	0
					West	Going ahead	Automobile, station wagon	Other motor vehicle	
2018-May-17, Thu,15:00	Clear	Rear end	P.D. only	Dry	East	Going ahead	Automobile, station wagon	Other motor vehicle	0
					East	Stopped	Automobile, station wagon	Other motor vehicle	
2018-May-29, Tue,08:48	Clear	Other	P.D. only	Dry	West	Reversing	School bus	Other motor vehicle	0
					East	Stopped	Automobile, station wagon	Other motor vehicle	
2018-Jun-25, Mon,15:50	Clear	Rear end	P.D. only	Dry	West	Turning left	Automobile, station wagon	Other motor vehicle	0
					West	Turning left	Automobile, station wagon	Other motor vehicle	
2018-Oct-03, Wed,07:44	Clear	Rear end	P.D. only	Dry	East	Going ahead	Automobile, station wagon	Other motor vehicle	0
					East	Stopped	Automobile, station wagon	Other motor vehicle	
2018-Nov-11, Sun,07:45	Clear	Angle	P.D. only	Dry	North	Making "U" turn	Automobile, station wagon	Other motor vehicle	0
					East	Going ahead	Automobile, station wagon	Other motor vehicle	
2018-Nov-22, Thu,11:15	Clear	Rear end	P.D. only	Dry	North	Turning right	Pick-up truck	Other motor vehicle	0
					North	Turning right	Automobile, station wagon	Other motor vehicle	
2019-Jan-16, Wed,14:25	Clear	Rear end	P.D. only	Dry	West	Turning left	Automobile, station wagon	Other motor vehicle	0
					West	Turning left	Automobile, station wagon	Other motor vehicle	
2019-Jan-21, Mon,09:19	Freezing Rain	Rear end	P.D. only	Ice	East	Going ahead	Unknown	Other motor vehicle	0
					East	Slowing or stopping	Pick-up truck	Other motor vehicle	



Transportation Services - Traffic Services

Collision Details Report - Public Version

From: January 1, 2016 To: December 31, 2020

Location: CONROY RD @ WALKLEY RD

Traffic Control: Traffic signal

Total Collisions: 74

Date/Day/Time	Environment	Impact Type	Classification	Surface Cond'n	Veh. Dir	Vehicle Manoeuvre	Vehicle type	First Event	No. Ped
2019-Feb-02, Sat,16:30	Snow	Rear end	P.D. only	Packed snow	North	Turning right	Automobile, station wagon	Other motor vehicle	0
					North	Turning right	Automobile, station wagon	Other motor vehicle	
2019-Feb-11, Mon,20:02	Clear	Other	P.D. only	Dry	West	Going ahead	Automobile, station wagon	Curb	0
					West	Going ahead	Automobile, station wagon	Other motor vehicle	
2019-Mar-07, Thu,16:30	Clear	Rear end	P.D. only	Ice	East	Going ahead	Automobile, station wagon	Other motor vehicle	0
					East	Stopped	Automobile, station wagon	Other motor vehicle	
					East	Unknown	Unknown	Other motor vehicle	
2019-Mar-20, Wed,16:49	Rain	Rear end	P.D. only	Wet	West	Going ahead	Automobile, station wagon	Other motor vehicle	0
					West	Stopped	Automobile, station wagon	Other motor vehicle	
2019-Apr-03, Wed,01:21	Clear	SMV other	P.D. only	Dry	East	Going ahead	Automobile, station wagon	Curb	0
2019-May-19, Sun,15:00	Rain	Angle	Non-fatal injury	Wet	East	Going ahead	Automobile, station wagon	Other motor vehicle	0
					North	Turning left	Automobile, station wagon	Other motor vehicle	
2019-May-21, Tue,14:55	Clear	Rear end	P.D. only	Dry	East	Stopped	Pick-up truck	Other motor vehicle	0
					East	Slowing or stopping	Pick-up truck	Other motor vehicle	
2019-Jun-03, Mon,14:47	Clear	Rear end	P.D. only	Dry	East	Slowing or stopping	Automobile, station wagon	Other motor vehicle	0
					East	Slowing or stopping	Automobile, station wagon	Other motor vehicle	
2019-Aug-13, Tue,16:25	Clear	Rear end	P.D. only	Dry	East	Slowing or stopping	Automobile, station wagon	Other motor vehicle	0
					East	Slowing or stopping	Automobile, station wagon	Other motor vehicle	
					East	Stopped	Automobile, station wagon	Other motor vehicle	
2019-Sep-18, Wed,16:36	Clear	Rear end	P.D. only	Dry	West	Going ahead	Automobile, station wagon	Other motor vehicle	0
					West	Stopped	Automobile, station wagon	Other motor vehicle	
2019-Oct-02, Wed,08:30	Clear	Rear end	P.D. only	Dry	North	Turning right	Automobile, station wagon	Other motor vehicle	0
					North	Turning right	Automobile, station wagon	Other motor vehicle	



Transportation Services - Traffic Services

Collision Details Report - Public Version

From: January 1, 2016 To: December 31, 2020

Location: CONROY RD @ WALKLEY RD

Traffic Control: Traffic signal

Total Collisions: 74

Date/Day/Time	Environment	Impact Type	Classification	Surface Cond'n	Veh. Dir	Vehicle Manoeuver	Vehicle type	First Event	No. Ped
2019-Oct-07, Mon,09:00	Clear	Rear end	P.D. only	Dry	North	Turning left	Automobile, station wagon	Other motor vehicle	0
					North	Turning left	Automobile, station wagon	Other motor vehicle	
2019-Nov-05, Tue,06:22	Clear	SMV other	Non-fatal injury	Dry	West	Going ahead	Automobile, station wagon	Pedestrian	1
2019-Nov-18, Mon,10:05	Clear	Rear end	P.D. only	Dry	East	Turning right	Automobile, station wagon	Other motor vehicle	0
					East	Turning right	Automobile, station wagon	Other motor vehicle	
2019-Nov-22, Fri,07:59	Clear	Rear end	P.D. only	Wet	North	Going ahead	Construction equipment	Other motor vehicle	0
					North	Stopped	Automobile, station wagon	Other motor vehicle	
2019-Dec-04, Wed,09:33	Snow	Rear end	P.D. only	Loose snow	West	Going ahead	Automobile, station wagon	Other motor vehicle	0
					West	Stopped	Automobile, station wagon	Other motor vehicle	
2019-Dec-13, Fri,15:49	Clear	Sideswipe	P.D. only	Wet	West	Turning left	Automobile, station wagon	Other motor vehicle	0
					West	Turning left	Automobile, station wagon	Other motor vehicle	
2019-Dec-16, Mon,14:29	Clear	Rear end	P.D. only	Ice	North	Slowing or stopping	Automobile, station wagon	Skidding/sliding	0
					North	Stopped	Automobile, station wagon	Other motor vehicle	
2019-Dec-16, Mon,16:23	Clear	Rear end	P.D. only	Dry	West	Slowing or stopping	Automobile, station wagon	Other motor vehicle	0
					West	Stopped	Pick-up truck	Other motor vehicle	
2019-Dec-27, Fri,11:30	Clear	Rear end	P.D. only	Ice	West	Going ahead	Automobile, station wagon	Skidding/sliding	0
					West	Stopped	Automobile, station wagon	Other motor vehicle	
2020-Feb-03, Mon,15:35	Clear	Rear end	P.D. only	Dry	West	Turning left	Automobile, station wagon	Other motor vehicle	0
					West	Turning left	Automobile, station wagon	Other motor vehicle	
2020-Mar-19, Thu,21:45	Clear	Rear end	P.D. only	Dry	East	Going ahead	Automobile, station wagon	Other motor vehicle	0
					East	Unknown	Automobile, station wagon	Other motor vehicle	
2020-May-12, Tue,11:56	Clear	Sideswipe	P.D. only	Dry	North	Turning left	Pick-up truck	Other motor vehicle	0
					North	Turning left	Passenger van	Other motor vehicle	



Transportation Services - Traffic Services

Collision Details Report - Public Version

From: January 1, 2016 To: December 31, 2020

Location: CONROY RD @ WALKLEY RD

Traffic Control: Traffic signal

Total Collisions: 74

Date/Day/Time	Environment	Impact Type	Classification	Surface Cond'n	Veh. Dir	Vehicle Manoeuvre	Vehicle type	First Event	No. Ped
2020-Jun-22, Mon,16:39	Rain	Angle	Non-fatal injury	Wet	East	Going ahead	Automobile, station wagon	Other motor vehicle	0
					North	Turning left	Automobile, station wagon	Other motor vehicle	
2020-Jul-27, Mon,13:55	Clear	Rear end	P.D. only	Dry	East	Going ahead	Automobile, station wagon	Other motor vehicle	0
					East	Stopped	Pick-up truck	Other motor vehicle	
					East	Stopped	Passenger van	Other motor vehicle	
2020-Jul-28, Tue,15:56	Clear	Sideswipe	P.D. only	Dry	West	Changing lanes	Pick-up truck	Other motor vehicle	0
					West	Going ahead	Automobile, station wagon	Other motor vehicle	
2020-Oct-20, Tue,20:55	Clear	Sideswipe	P.D. only	Dry	East	Changing lanes	Unknown	Other motor vehicle	0
					East	Turning right	Automobile, station wagon	Other motor vehicle	
2020-Oct-31, Sat,15:48	Clear	Rear end	P.D. only	Dry	North	Turning right	Pick-up truck	Other motor vehicle	0
					North	Turning right	Automobile, station wagon	Other motor vehicle	

Location: CONROY RD btwn ST. LAURENT BLVD & WALKLEY RD

Traffic Control: No control

Total Collisions: 3

Date/Day/Time	Environment	Impact Type	Classification	Surface Cond'n	Veh. Dir	Vehicle Manoeuvre	Vehicle type	First Event	No. Ped
2016-Jan-16, Sat,12:02	Snow	Sideswipe	P.D. only	Loose snow	North	Changing lanes	Unknown	Other motor vehicle	0
					North	Going ahead	Pick-up truck	Other motor vehicle	
2017-Sep-23, Sat,18:45	Clear	SMV other	Non-fatal injury	Dry	North	Turning right	Automobile, station wagon	Ran off road	0
2019-Jan-14, Mon,14:54	Clear	Rear end	P.D. only	Dry	South	Unknown	Unknown	Other motor vehicle	0
					South	Slowing or stopping	Automobile, station wagon	Other motor vehicle	

Location: DON REID DR @ ST. LAURENT BLVD

Traffic Control: Stop sign

Total Collisions: 1

Date/Day/Time	Environment	Impact Type	Classification	Surface Cond'n	Veh. Dir	Vehicle Manoeuvre	Vehicle type	First Event	No. Ped
---------------	-------------	-------------	----------------	----------------	----------	-------------------	--------------	-------------	---------



Transportation Services - Traffic Services

Collision Details Report - Public Version

From: January 1, 2016 To: December 31, 2020

Location: DON REID DR @ ST. LAURENT BLVD

Traffic Control: Stop sign

Total Collisions: 1

Date/Day/Time	Environment	Impact Type	Classification	Surface Cond'n	Veh. Dir	Vehicle Manoeuvre	Vehicle type	First Event	No. Ped
2016-Feb-28, Sun,09:00	Snow	Angle	P.D. only	Loose snow	West	Turning left	Automobile, station wagon	Other motor vehicle	0
					North	Going ahead	Automobile, station wagon	Other motor vehicle	

Location: ST. LAURENT BLVD btwn CONROY RD & DON REID DR

Traffic Control: No control

Total Collisions: 2

Date/Day/Time	Environment	Impact Type	Classification	Surface Cond'n	Veh. Dir	Vehicle Manoeuvre	Vehicle type	First Event	No. Ped
2019-Jan-15, Tue,13:02	Clear	SMV other	P.D. only	Wet	East	Going ahead	Automobile, station wagon	Skidding/sliding	0
2020-Feb-12, Wed,16:22	Snow	Angle	P.D. only	Wet	North	Turning right	Pick-up truck	Other motor vehicle	0
					East	Going ahead	Passenger van	Other motor vehicle	

Location: WALKLEY RD @ DON REID DR/Ryder ST

Traffic Control: Traffic signal

Total Collisions: 37

Date/Day/Time	Environment	Impact Type	Classification	Surface Cond'n	Veh. Dir	Vehicle Manoeuvre	Vehicle type	First Event	No. Ped
2016-Apr-10, Sun,13:12	Clear	Angle	Non-fatal injury	Dry	West	Going ahead	Automobile, station wagon	Other motor vehicle	0
					South	Turning left	Automobile, station wagon	Other motor vehicle	
2016-Jun-19, Sun,07:07	Clear	Angle	Non-fatal injury	Dry	West	Going ahead	Automobile, station wagon	Other motor vehicle	0
					South	Turning left	Automobile, station wagon	Other motor vehicle	
2016-Jul-15, Fri,11:05	Clear	Angle	Non-fatal injury	Dry	West	Going ahead	Bicycle	Other motor vehicle	0
					North	Turning right	Pick-up truck	Cyclist	
2016-Sep-19, Mon,15:35	Clear	Angle	Non-fatal injury	Dry	North	Turning right	Unknown	Cyclist	0
					West	Going ahead	Bicycle	Other motor vehicle	
2016-Dec-12, Mon,15:21	Snow	Angle	Non-fatal injury	Loose snow	West	Going ahead	Pick-up truck	Other motor vehicle	0
					South	Going ahead	Pick-up truck	Other motor vehicle	
2017-Mar-14, Tue,18:18	Snow	SMV other	P.D. only	Loose snow	East	Slowing or stopping	Pick-up truck	Ran off road	0
2017-Mar-24, Fri,11:16	Snow	SMV other	P.D. only	Wet	South	Slowing or stopping	Pick-up truck	Pole (utility, power)	0



Transportation Services - Traffic Services

Collision Details Report - Public Version

From: January 1, 2016 **To:** December 31, 2020

Location: WALKLEY RD @ DON REID DR/Ryder ST

Traffic Control: Traffic signal

Total Collisions: 37

Date/Day/Time	Environment	Impact Type	Classification	Surface Cond'n	Veh. Dir	Vehicle Manoeuvre	Vehicle type	First Event	No. Ped
2017-May-29, Mon,10:40	Rain	Angle	P.D. only	Wet	West	Going ahead	Automobile, station wagon	Other motor vehicle	0
					South	Turning left	Pick-up truck	Other motor vehicle	
2017-Jun-04, Sun,12:37	Clear	Angle	P.D. only	Dry	West	Going ahead	Pick-up truck	Other motor vehicle	0
					South	Going ahead	Automobile, station wagon	Other motor vehicle	
2017-Jun-28, Wed,15:34	Clear	Angle	Non-fatal injury	Dry	West	Going ahead	Passenger van	Other motor vehicle	0
					South	Going ahead	Automobile, station wagon	Other motor vehicle	
2017-Jun-28, Wed,15:51	Clear	Rear end	P.D. only	Dry	East	Going ahead	Automobile, station wagon	Other motor vehicle	0
					East	Slowing or stopping	Passenger van	Other motor vehicle	
					East	Slowing or stopping	Automobile, station wagon	Other motor vehicle	
2017-Aug-08, Tue,07:30	Clear	Rear end	P.D. only	Dry	West	Changing lanes	Automobile, station wagon	Other motor vehicle	0
					West	Slowing or stopping	Pick-up truck	Other motor vehicle	
2017-Sep-02, Sat,16:25	Clear	Angle	Non-fatal injury	Dry	West	Going ahead	Automobile, station wagon	Other motor vehicle	0
					South	Turning left	Automobile, station wagon	Other motor vehicle	
2017-Sep-26, Tue,23:04	Clear	Rear end	P.D. only	Dry	East	Unknown	Unknown	Other motor vehicle	0
					East	Going ahead	Automobile, station wagon	Other motor vehicle	
2017-Oct-20, Fri,17:15	Clear	Rear end	Non-fatal injury	Dry	East	Going ahead	Pick-up truck	Other motor vehicle	0
					East	Stopped	Automobile, station wagon	Other motor vehicle	
2018-Feb-15, Thu,08:51	Freezing Rain	Rear end	P.D. only	Ice	West	Slowing or stopping	Automobile, station wagon	Skidding/sliding	0
					West	Turning left	Delivery van	Other motor vehicle	
2018-Mar-11, Sun,18:03	Clear	Sideswipe	P.D. only	Dry	West	Going ahead	Unknown	Other motor vehicle	0
					West	Going ahead	Automobile, station wagon	Other motor vehicle	
2018-Mar-16, Fri,17:52	Clear	Angle	P.D. only	Dry	West	Slowing or stopping	Automobile, station wagon	Other motor vehicle	0
					South	Going ahead	Automobile, station wagon	Other motor vehicle	



Transportation Services - Traffic Services

Collision Details Report - Public Version

From: January 1, 2016 To: December 31, 2020

Location: WALKLEY RD @ DON REID DR/Ryder ST

Traffic Control: Traffic signal

Total Collisions: 37

Date/Day/Time	Environment	Impact Type	Classification	Surface Cond'n	Veh. Dir	Vehicle Manoeuvre	Vehicle type	First Event	No. Ped
2018-Sep-23, Sun,15:20	Clear	Angle	P.D. only	Dry	West	Going ahead	Automobile, station wagon	Other motor vehicle	0
					South	Going ahead	Automobile, station wagon	Other motor vehicle	
2018-Nov-13, Tue,15:20	Freezing Rain	Rear end	P.D. only	Wet	East	Slowing or stopping	Automobile, station wagon	Other motor vehicle	0
					East	Stopped	Automobile, station wagon	Other motor vehicle	
2019-Jan-20, Sun,19:26	Snow	Approaching	Non-fatal injury	Loose snow	East	Going ahead	Automobile, station wagon	Other motor vehicle	0
					West	Turning left	Ambulance	Other motor vehicle	
2019-Feb-02, Sat,17:30	Snow	Angle	P.D. only	Wet	West	Going ahead	Passenger van	Other motor vehicle	0
					South	Going ahead	Automobile, station wagon	Other motor vehicle	
2019-Feb-03, Sun,06:57	Snow	Turning movement	P.D. only	Slush	East	Turning left	Automobile, station wagon	Other motor vehicle	0
					West	Going ahead	Pick-up truck	Other motor vehicle	
2019-Feb-15, Fri,16:15	Clear	Rear end	Non-fatal injury	Wet	West	Going ahead	Automobile, station wagon	Other motor vehicle	0
					West	Stopped	Automobile, station wagon	Other motor vehicle	
2019-Jun-12, Wed,18:00	Clear	Rear end	P.D. only	Dry	East	Going ahead	Automobile, station wagon	Other motor vehicle	0
					East	Stopped	Automobile, station wagon	Other motor vehicle	
2019-Jun-17, Mon,06:45	Clear	Angle	P.D. only	Dry	West	Going ahead	Automobile, station wagon	Other motor vehicle	0
					South	Turning left	Pick-up truck	Other motor vehicle	
2019-Jun-23, Sun,15:09	Clear	Angle	P.D. only	Dry	West	Going ahead	Automobile, station wagon	Other motor vehicle	0
					South	Turning left	Automobile, station wagon	Other motor vehicle	
2019-Sep-05, Thu,09:44	Clear	Sideswipe	P.D. only	Dry	East	Changing lanes	Fire vehicle	Other motor vehicle	0
					East	Going ahead	Automobile, station wagon	Other motor vehicle	
2019-Sep-17, Tue,16:30	Clear	Rear end	P.D. only	Dry	South	Going ahead	Automobile, station wagon	Other motor vehicle	0
					South	Turning right	Automobile, station wagon	Other motor vehicle	
2019-Nov-01, Fri,13:59	Clear	Angle	P.D. only	Dry	West	Turning left	School bus	Other motor vehicle	0
					South	Going ahead	Automobile, station wagon	Other motor vehicle	



Transportation Services - Traffic Services

Collision Details Report - Public Version

From: January 1, 2016 To: December 31, 2020

Location: WALKLEY RD @ DON REID DR/Ryder ST

Traffic Control: Traffic signal

Total Collisions: 37

Date/Day/Time	Environment	Impact Type	Classification	Surface Cond'n	Veh. Dir	Vehicle Manoeuvre	Vehicle type	First Event	No. Ped
2019-Dec-19, Thu,16:18	Clear	Angle	P.D. only	Wet	West	Going ahead	Fire vehicle	Other motor vehicle	0
					South	Going ahead	Automobile, station wagon	Other motor vehicle	
2019-Dec-24, Tue,12:55	Clear	Rear end	P.D. only	Dry	West	Slowing or stopping	Automobile, station wagon	Other motor vehicle	0
					West	Stopped	Automobile, station wagon	Other motor vehicle	
2020-Feb-04, Tue,15:55	Clear	Rear end	P.D. only	Wet	West	Going ahead	Automobile, station wagon	Other motor vehicle	0
					West	Slowing or stopping	Automobile, station wagon	Other motor vehicle	
					West	Slowing or stopping	Automobile, station wagon	Other motor vehicle	
					West	Slowing or stopping	Automobile, station wagon	Other motor vehicle	
2020-Feb-06, Thu,16:40	Clear	Rear end	P.D. only	Dry	West	Going ahead	Passenger van	Other motor vehicle	0
					West	Slowing or stopping	Delivery van	Other motor vehicle	
2020-Apr-10, Fri,20:00	Clear	Sideswipe	P.D. only	Dry	East	Changing lanes	Automobile, station wagon	Other motor vehicle	0
					East	Going ahead	Pick-up truck	Other motor vehicle	
2020-May-02, Sat,16:17	Clear	Angle	P.D. only	Dry	West	Going ahead	Automobile, station wagon	Other motor vehicle	0
					South	Turning left	Pick-up truck	Other motor vehicle	
2020-May-29, Fri,09:20	Clear	Rear end	P.D. only	Dry	West	Going ahead	Construction equipment	Other motor vehicle	0
					West	Slowing or stopping	Automobile, station wagon	Other motor vehicle	

Location: WALKLEY RD btwn 160 W OF CONROY RD & CONROY RD

Traffic Control: No control

Total Collisions: 7

Date/Day/Time	Environment	Impact Type	Classification	Surface Cond'n	Veh. Dir	Vehicle Manoeuvre	Vehicle type	First Event	No. Ped
2017-Oct-26, Thu,15:41	Clear	Rear end	P.D. only	Dry	East	Going ahead	Automobile, station wagon	Other motor vehicle	0
					East	Stopped	Pick-up truck	Other motor vehicle	
2017-Nov-24, Fri,16:41	Clear	Rear end	P.D. only	Wet	East	Going ahead	Automobile, station wagon	Other motor vehicle	0
					East	Stopped	Pick-up truck	Other motor vehicle	



Transportation Services - Traffic Services

Collision Details Report - Public Version

From: January 1, 2016 To: December 31, 2020

Location: WALKLEY RD btwn 160 W OF CONROY RD & CONROY RD

Traffic Control: No control

Total Collisions: 7

Date/Day/Time	Environment	Impact Type	Classification	Surface Cond'n	Veh. Dir	Vehicle Manoeuver	Vehicle type	First Event	No. Ped
2018-Oct-10, Wed,14:20	Clear	Turning movement	P.D. only	Dry	East	Turning right	Automobile, station wagon	Other motor vehicle	0
					East	Going ahead	Automobile, station wagon	Other motor vehicle	
2019-Feb-02, Sat,15:00	Snow	Rear end	P.D. only	Loose snow	East	Slowing or stopping	Automobile, station wagon	Other motor vehicle	0
					East	Stopped	Passenger van	Other motor vehicle	
2019-May-08, Wed,05:01	Clear	Angle	P.D. only	Dry	North	Turning right	Automobile, station wagon	Other motor vehicle	0
					East	Going ahead	Automobile, station wagon	Other motor vehicle	
2019-May-24, Fri,13:04	Clear	Angle	P.D. only	Dry	North	Turning right	Unknown	Other motor vehicle	0
					East	Going ahead	Pick-up truck	Other motor vehicle	
2020-Sep-25, Fri,19:26	Clear	Rear end	P.D. only	Dry	West	Changing lanes	Motorcycle	Other motor vehicle	0
					West	Slowing or stopping	Automobile, station wagon	Other motor vehicle	

Location: WALKLEY RD btwn 160 W OF CONROY RD & DON REID DR/Ryder ST

Traffic Control: No control

Total Collisions: 5

Date/Day/Time	Environment	Impact Type	Classification	Surface Cond'n	Veh. Dir	Vehicle Manoeuver	Vehicle type	First Event	No. Ped
2017-May-13, Sat,12:47	Rain	Rear end	P.D. only	Wet	East	Slowing or stopping	Automobile, station wagon	Other motor vehicle	0
					East	Slowing or stopping	Passenger van	Other motor vehicle	
					East	Stopped	Automobile, station wagon	Other motor vehicle	
2018-Jan-30, Tue,17:29	Clear	Rear end	P.D. only	Dry	East	Slowing or stopping	Automobile, station wagon	Other motor vehicle	0
					East	Slowing or stopping	Automobile, station wagon	Other motor vehicle	
					East	Slowing or stopping	Automobile, station wagon	Other motor vehicle	
2018-Feb-15, Thu,13:43	Clear	Sideswipe	P.D. only	Wet	East	Unknown	Unknown	Other motor vehicle	0
					East	Going ahead	Truck - closed	Other motor vehicle	
2019-Apr-09, Tue,07:45	Freezing Rain	Rear end	P.D. only	Ice	East	Slowing or stopping	Passenger van	Other motor vehicle	0
					East	Stopped	Pick-up truck	Other motor vehicle	



Transportation Services - Traffic Services

Collision Details Report - Public Version

From: January 1, 2016 **To:** December 31, 2020

Location: WALKLEY RD btwn 160 W OF CONROY RD & DON REID DR/Ryder ST

Traffic Control: No control

Total Collisions: 5

Date/Day/Time	Environment	Impact Type	Classification	Surface Cond'n	Veh. Dir	Vehicle Manoeuver	Vehicle type	First Event	No. Ped
2020-Aug-05, Wed, 12:41	Clear	Rear end	P.D. only	Dry	East	Going ahead	Truck - tank	Other motor vehicle	0
					East	Stopped	Municipal transit bus	Other motor vehicle	

No.	Location	Date	Time	Environment	Road_Surface	Traffic_Control	Collision_Location	Light	Collision_Classification	Impact_Type
1	WALKLEY RD @ 160 W OF CONROY RD	5/11/2017	5:42	01 - Clear	01 - Dry	01 - Traffic signal	02 - Intersection related	03 - Dawn	02 - Non-fatal injury	07 - SMV other
2	WALKLEY RD @ 160 W OF CONROY RD (0011391)	6/11/2018	15:36	01 - Clear	01 - Dry	01 - Traffic signal	02 - Intersection related	01 - Daylight	02 - Non-fatal injury	03 - Rear end
3	WALKLEY RD @ 160 W OF CONROY RD (0011391)	6/12/2018	14:02	01 - Clear	01 - Dry	01 - Traffic signal	03 - At intersection	01 - Daylight	02 - Non-fatal injury	05 - Turning movement
4	WALKLEY RD @ 160 W OF CONROY RD (0011391)	1/25/2019	15:46	01 - Clear	01 - Dry	01 - Traffic signal	02 - Intersection related	01 - Daylight	03 - P.D. only	03 - Rear end
5	WALKLEY RD @ 160 W OF CONROY RD (0011391)	1/26/2019	16:37	01 - Clear	01 - Dry	01 - Traffic signal	02 - Intersection related	01 - Daylight	02 - Non-fatal injury	03 - Rear end
6	WALKLEY RD @ 160 W OF CONROY RD (0011391)	3/29/2019	17:13	01 - Clear	01 - Dry	01 - Traffic signal	03 - At intersection	01 - Daylight	02 - Non-fatal injury	05 - Turning movement
7	WALKLEY RD @ 160 W OF CONROY RD (0011391)	4/30/2019	9:06	01 - Clear	01 - Dry	01 - Traffic signal	02 - Intersection related	01 - Daylight	03 - P.D. only	03 - Rear end
8	WALKLEY RD @ 160 W OF CONROY RD (0011391)	12/4/2019	14:35	01 - Clear	01 - Dry	01 - Traffic signal	02 - Intersection related	01 - Daylight	03 - P.D. only	99 - Other
9	WALKLEY RD @ 160 W OF CONROY RD (0011391)	10/16/2020	10:26	01 - Clear	02 - Wet	01 - Traffic signal	02 - Intersection related	01 - Daylight	03 - P.D. only	03 - Rear end
10	WALKLEY RD @ 160 W OF CONROY RD (0011391)	10/24/2020	6:08	02 - Rain	02 - Wet	01 - Traffic signal	03 - At intersection	07 - Dark	02 - Non-fatal injury	05 - Turning movement
11	WALKLEY RD @ 160 W OF CONROY RD (0011391)	12/30/2020	11:40	05 - Drifting Snow	03 - Loose snow	01 - Traffic signal	03 - At intersection	01 - Daylight	02 - Non-fatal injury	05 - Turning movement

APPENDIX F

Relevant Excerpts of *TRANS Trip Generation Manual* (WSP, 2020)

3.2 Recommended Residential Trip Generation Rates

A blended trip rate was developed from the three data sources through application of a rank-sum weighting process, considering the strengths and weaknesses of each dataset for the dwelling type in question. The recommended blended **residential person-trip rates** are presented in **Table 3**. All rates represent person-trips per dwelling unit and are to be applied to the **AM or PM peak period**.

Table 3: Recommended Residential Person-trip Rates

ITE Land Use Code	Dwelling Unit Type	Period	Person-Trip Rate
210	Single-detached	AM	2.05
		PM	2.48
220	Multi-Unit (Low-Rise)	AM	1.35
		PM	1.58
221 & 222	Multi-Unit (High-Rise)	AM	0.80
		PM	0.90

3.3 Adjustment Factors – Peak Period to Peak Hour

The various trip generation data sources require some adjustment to standardize the data for developing robust blended trip rates. The peak period conversion factor in **Table 4** may be used where applicable to develop trip generation rate estimates in the desired format.

Table 4: Adjustment Factors for Residential Trip Generation Rates

Factor	Application	Apply To	Period	Value
Peak Period Conversion Factor	Peak period to peak hour conversion. Because the 2020 TRANS Trip Generation Study reports trip generation rates by peak period, factors must be applied if the practitioner requires peak hour rates. In practice, the conversion to peak hour trip rates should occur after the application of modal shares.	Person-trip rates per peak period	AM	0.50
			PM	0.44
		Vehicle trip rates per peak period	AM	0.48
			PM	0.44
		Transit trip rates per peak period	AM	0.55
			PM	0.47
		Cycling trip rates per peak period	AM	0.58
			PM	0.48
		Walking trip rates per peak period	AM	0.58
			PM	0.52

Table 7: Residential Mode Share for Low-Rise Multifamily Housing

District	Period	Mode				
		Auto Driver	Auto Pass.	Transit	Cycling	Walking
Ottawa Centre	AM	27%	9%	25%	9%	30%
	PM	31%	10%	20%	9%	30%
Ottawa Inner Area	AM	27%	8%	26%	9%	30%
	PM	31%	9%	20%	9%	31%
Île de Hull	AM	27%	9%	25%	9%	30%
	PM	34%	22%	16%	5%	22%
Ottawa East	AM	36%	11%	38%	7%	8%
	PM	39%	16%	29%	5%	11%
Beacon Hill	AM	45%	9%	35%	1%	10%
	PM	48%	16%	24%	1%	11%
Alta Vista	AM	38%	15%	35%	1%	10%
	PM	38%	19%	31%	2%	10%
Hunt Club	AM	44%	11%	38%	1%	6%
	PM	47%	15%	29%	1%	8%
Merivale	AM	44%	11%	32%	6%	7%
	PM	44%	12%	29%	4%	11%
Ottawa West	AM	36%	12%	24%	10%	19%
	PM	35%	12%	16%	10%	27%
Bayshore/Cedarview	AM	43%	11%	31%	1%	13%
	PM	44%	14%	25%	1%	15%
Hull Périphérie	AM	46%	22%	22%	4%	6%
	PM	46%	17%	22%	3%	11%
Orleans	AM	47%	15%	29%	1%	9%
	PM	51%	19%	24%	1%	6%
South Gloucester / Leitrim	AM	59%	20%	16%	1%	4%
	PM	62%	18%	17%	1%	3%
South Nepean	AM	49%	13%	26%	2%	9%
	PM	49%	13%	24%	2%	12%
Kanata - Stittsville	AM	52%	14%	22%	0%	11%
	PM	58%	17%	17%	0%	8%
Plateau	AM	44%	18%	28%	4%	6%
	PM	47%	17%	26%	2%	8%
Aylmer	AM	52%	18%	23%	0%	7%
	PM	52%	16%	20%	1%	12%
Pointe Gatineau	AM	46%	17%	23%	0%	14%
	PM	52%	16%	19%	1%	12%
Gatineau Est	AM	54%	17%	20%	1%	8%
	PM	56%	21%	16%	0%	7%
Masson-Angers	AM	60%	15%	21%	4%	1%
	PM	63%	15%	17%	3%	1%
Other Rural Districts	AM	66%	13%	21%	1%	0%
	PM	62%	19%	16%	3%	0%

Table 8: Residential Mode Share for High-Rise Multifamily Housing

District	Period	Mode				
		Auto Driver	Auto Pass.	Transit	Cycling	Walking
Ottawa Centre	AM	18%	2%	26%	1%	52%
	PM	17%	9%	21%	1%	52%
Ottawa Inner Area	AM	26%	6%	28%	5%	34%
	PM	25%	8%	21%	6%	39%
Île de Hull	AM	27%	3%	37%	12%	21%
	PM	26%	8%	27%	11%	28%
Ottawa East	AM	39%	7%	38%	2%	13%
	PM	40%	14%	28%	3%	15%
Beacon Hill	AM	48%	9%	30%	3%	10%
	PM	52%	16%	28%	0%	4%
Alta Vista	AM	38%	12%	42%	2%	7%
	PM	45%	16%	28%	2%	9%
Hunt Club	AM	39%	6%	44%	1%	9%
	PM	44%	11%	35%	2%	9%
Merivale	AM	41%	6%	42%	2%	8%
	PM	41%	11%	33%	2%	13%
Ottawa West	AM	28%	11%	41%	3%	16%
	PM	33%	11%	26%	7%	23%
Bayshore/Cedarview	AM	40%	12%	38%	2%	8%
	PM	40%	15%	33%	1%	11%
Hull Périphérie	AM	48%	11%	30%	1%	10%
	PM	47%	15%	23%	3%	13%
Orleans	AM	54%	7%	29%	0%	10%
	PM	61%	13%	21%	0%	6%
South Gloucester / Leitrim	AM	50%	15%	25%	1%	9%
	PM	53%	17%	21%	1%	9%
South Nepean	AM	58%	6%	30%	2%	4%
	PM	54%	15%	25%	0%	7%
Kanata - Stittsville	AM	43%	26%	28%	0%	4%
	PM	55%	19%	21%	0%	5%
Plateau	AM	53%	9%	35%	3%	1%
	PM	65%	7%	25%	2%	1%
Aylmer	AM	45%	17%	25%	0%	13%
	PM	31%	21%	23%	4%	20%
Pointe Gatineau	AM	44%	15%	24%	3%	14%
	PM	52%	15%	20%	2%	11%
Gatineau Est	AM	53%	10%	25%	0%	12%
	PM	61%	10%	25%	0%	4%
Masson-Angers	AM	63%	15%	19%	0%	3%
	PM	64%	18%	16%	0%	1%
Other Rural Districts	AM	63%	15%	19%	0%	3%
	PM	64%	18%	16%	0%	1%

5 RESIDENTIAL DIRECTIONAL SPLITS

After calculating the total person trips generated by the development and applying the appropriate modal shares, directional factors can be applied to estimate the number of inbound and outbound trips by vehicle. The vehicle trip directional splits were developed for both the AM and PM peak periods². The vehicle trip directional splits, as shown in **Table 9**, have been developed for the NCR based on a review of the local trip generator surveys as well as the latest published data in the *ITE Trip Generation Manual* (10th Edition).

Table 9: Recommended Vehicle Trip Directional Splits (Peak Period)

ITE Land Use Code	Dwelling Unit Type	Period	Inbound	Outbound
210	Single-detached	AM	30%	70%
		PM	62%	38%
220	Multi-Unit (Low-Rise)	AM	30%	70%
		PM	56%	44%
221 & 222	Multi-Unit (High-Rise)	AM	31%	69%
		PM	58%	42%

6 NON-RESIDENTIAL MODE SHARE

Mode shares were developed for three types of non-residential development: schools (elementary and high school); employment generators; and commercial (retail) generators. These mode shares were developed through data provided by the Ville de Gatineau from local school surveys as well as the TRANS Origin-Destination Survey. The non-residential mode shares presented below are limited and do not capture all development types. For data on the travel characteristics associated with colleges and universities, transportation terminals, and sports and entertainment venues in the National Capital Region, practitioners should refer to the various reports for the TRANS *Special Generators Survey* (2013), which are posted on the TRANS website. For other development types, practitioners may need to carry out their own local generator data collection where necessary.

² A directional split for active transportation was calculated based on the local generator surveys for low-rise and mid-rise land uses. The splits are mostly in-line with the vehicle directional splits, which could be used as a rough assumption for areas with lower vehicle mode share.

APPENDIX G

Other Area Developments

Timbercreek Heron Gate Official Plan Amendment Transportation Impact Assessment

Step 1 Screening Report

Step 2 Scoping Report

Step 3 Forecasting Report

Step 4 Strategy Report (revision #3)

Prepared for:

Timbercreek Asset Management
25 Price Street
Toronto, ON M4W 1Z1

Prepared by:



13 Markham Avenue
Ottawa, ON K2G 3Z1

April 2021

PN: 2018-49

Figure 1: Area Context Plan



Source: <http://maps.ottawa.ca/geoOttawa/> Accessed: October 27, 2020

Figure 11: New 2030 Site Generation Auto Volumes

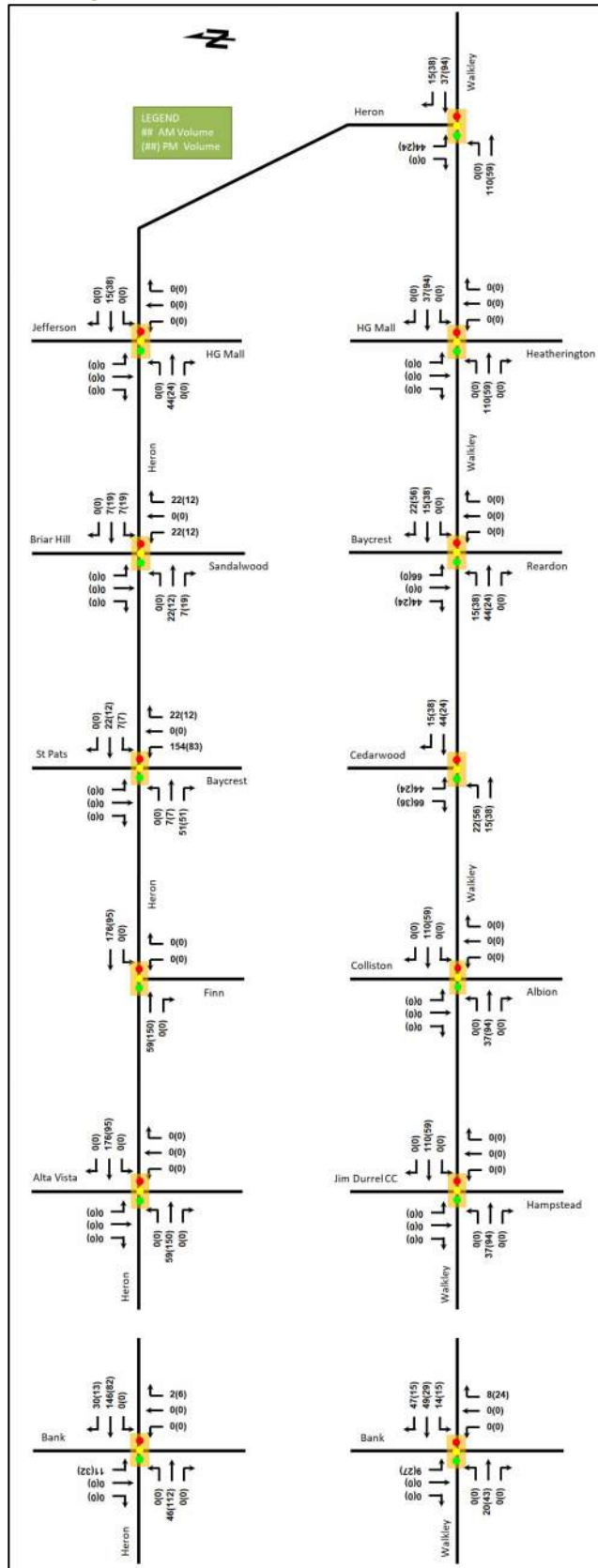

**2020 Walkley Road & 2935 Conroy Road
Transportation Impact Assessment**

Prepared By:

NOVATECH

Suite 200, 240 Michael Cowpland Drive
Ottawa, Ontario
K2M 1P6

March 2021

Rev: August 2021

Novatech File: 119067

Ref: R-2020-124

C:\temp\AcPublish_15748119067-Context.dwg, 119067-CP, Mar 10, 2021 - 1:39pm, rhillier

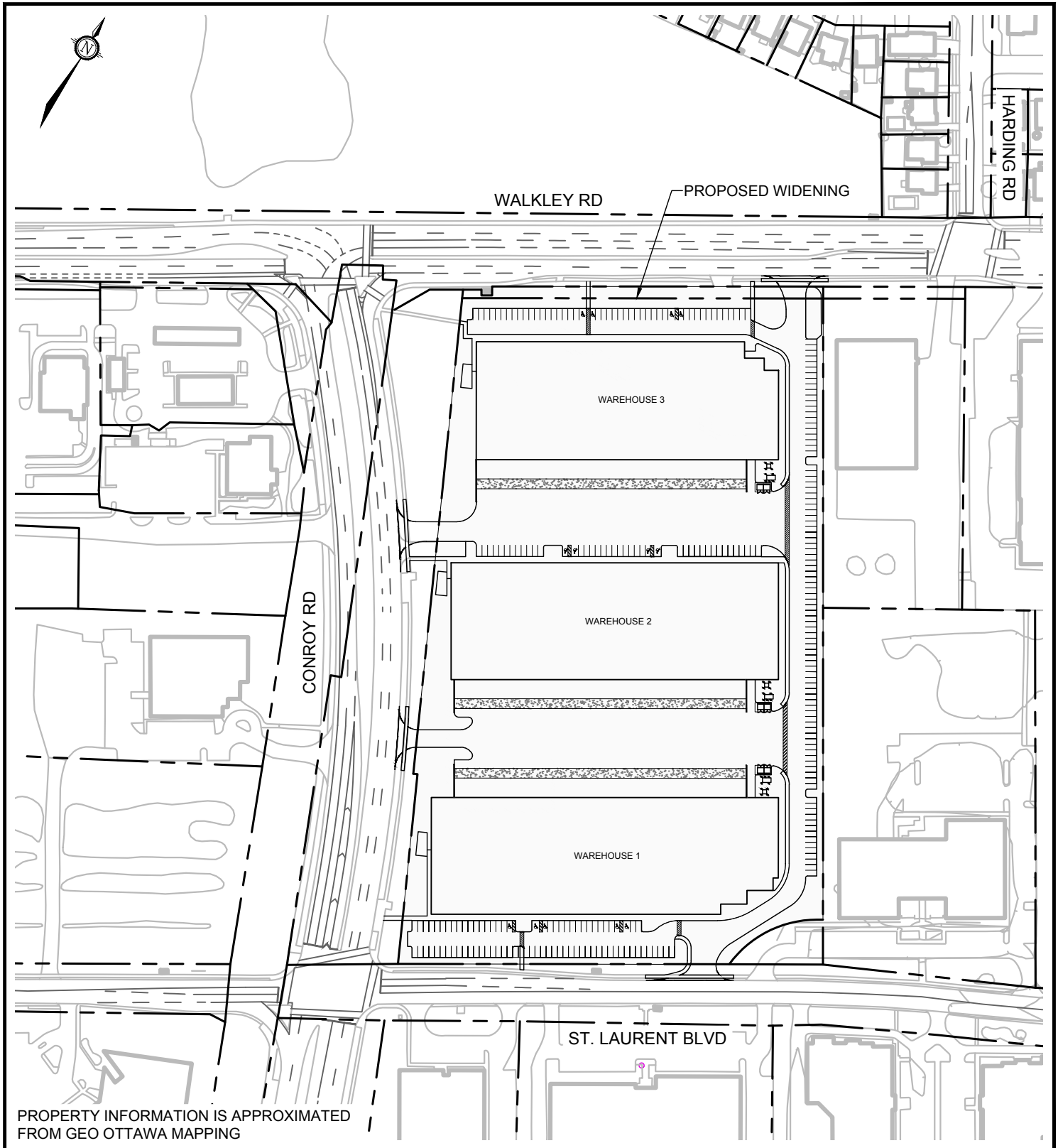

PROPERTY INFORMATION IS APPROXIMATED FROM GEO OTTAWA MAPPING



Engineers, Planners & Landscape Architects
Suite 200, 240 Michael Cowpland Drive
Ottawa, Ontario, Canada K2M 1P6

Telephone (613) 254-9643
Facsimile (613) 254-5867
Website www.novatech-eng.com

2020 WALKLEY ROAD

CONTEXT PLAN

SCALE 1 : 2500

DATE AUG 2021 JOB 119067 FIGURE FIGURE 2

The net assignment of trips with site redevelopment (Proposed Site Generated Trips, **Figure 5** less Existing Site Generated Trips, **Figure 6**) is shown in **Figure 7**.

Figure 7: Net Trip Assignment for Site Redevelopment

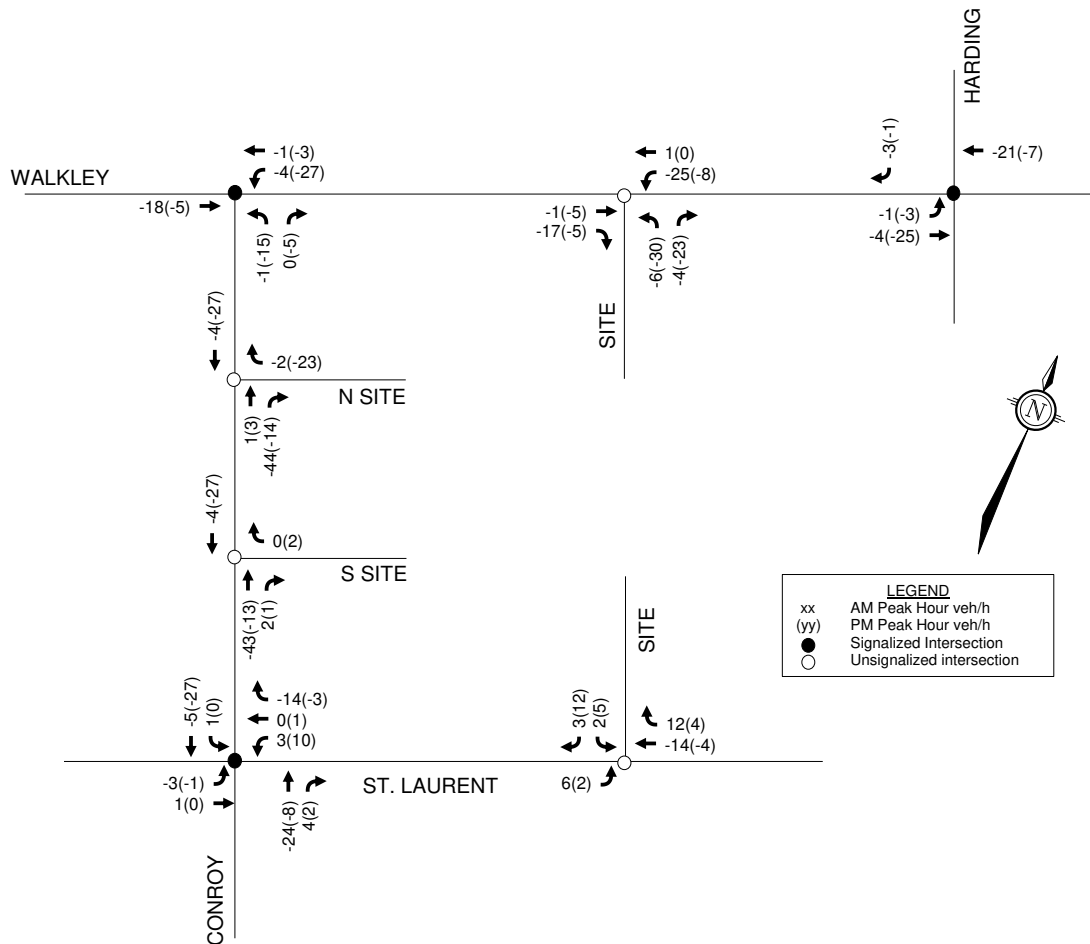

Truck access is primarily expected to be from / to the east on Walkley and Highway 417. Trucks are expected to travel via Walkley Road, Conroy Road, and St. Laurent Boulevard. Truck departures are expected to primarily be from the Conroy Road driveways due to the connections from the truck courts.

5.2 Background Traffic

5.2.1 Future Background Growth

For the 'Inner Suburbs' area of Ottawa, Exhibit 2.10 of the 2013 TMP projects population and employment growth rates of approximately 0.3% and 1.2% per annum, respectively. A 1% background growth rate has been applied to non-site traffic in this area.

This 1% background growth rate is in line with the annual historical (2000 to 2016) growth rate for this area (-2% to 2%) identified by the City of Ottawa (See **Figure 8**).



September 7, 2017
File: 163601146

Attention: Simon Nehme
Conroy Business Park Inc.
1890 Broadmoor Ave
Ottawa, Ontario
K1H 5B4

Dear Mr. Nehme,

Reference: 2500 St Laurent Blvd Transportation Brief

1.0 INTRODUCTION

Conroy Business Park Inc. is seeking site plan approval for a proposed office development located at 2500 St Laurent Boulevard in the Alta Vista area of the City of Ottawa. Stantec Consulting Ltd. was retained to undertake a Transportation Brief to determine the potential transportation implications of the proposed office development.

This Transportation Brief includes:

- A description of the proposed office development;
- A review of the site plan to confirm site access location;
- An overview of the existing surrounding transportation environment, including an operational assessment of the study area intersections under 2017 existing conditions;
- The volume of site traffic the proposed office development is anticipated to generate during the AM and PM roadway peak hours;
- An operational assessment of the study area intersections under 2021 total future conditions (site build-out); and
- An operational assessment of the study area intersections under 2026 ultimate future conditions (5-years beyond build-out).



Reference: 2500 St Laurent Blvd Transportation Brief

Figure 7 - Auto Trips Generated at the Site during AM Peak Period

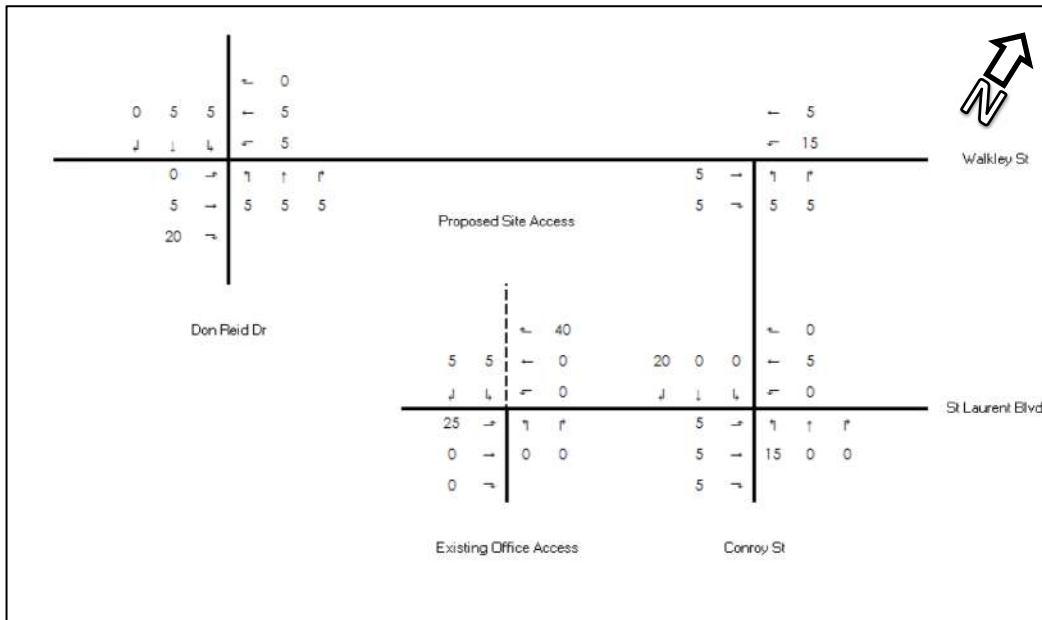
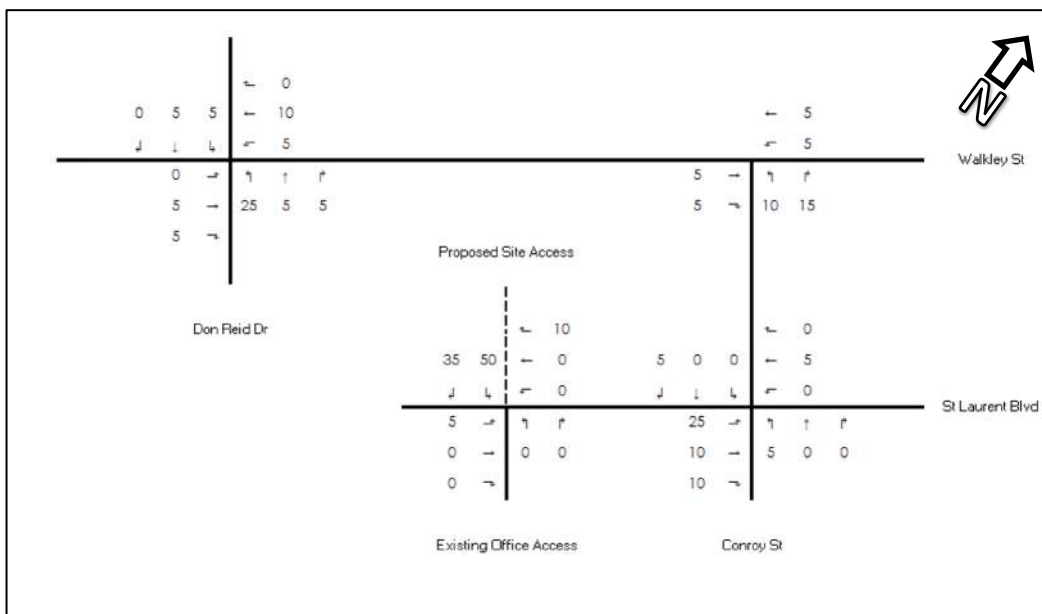
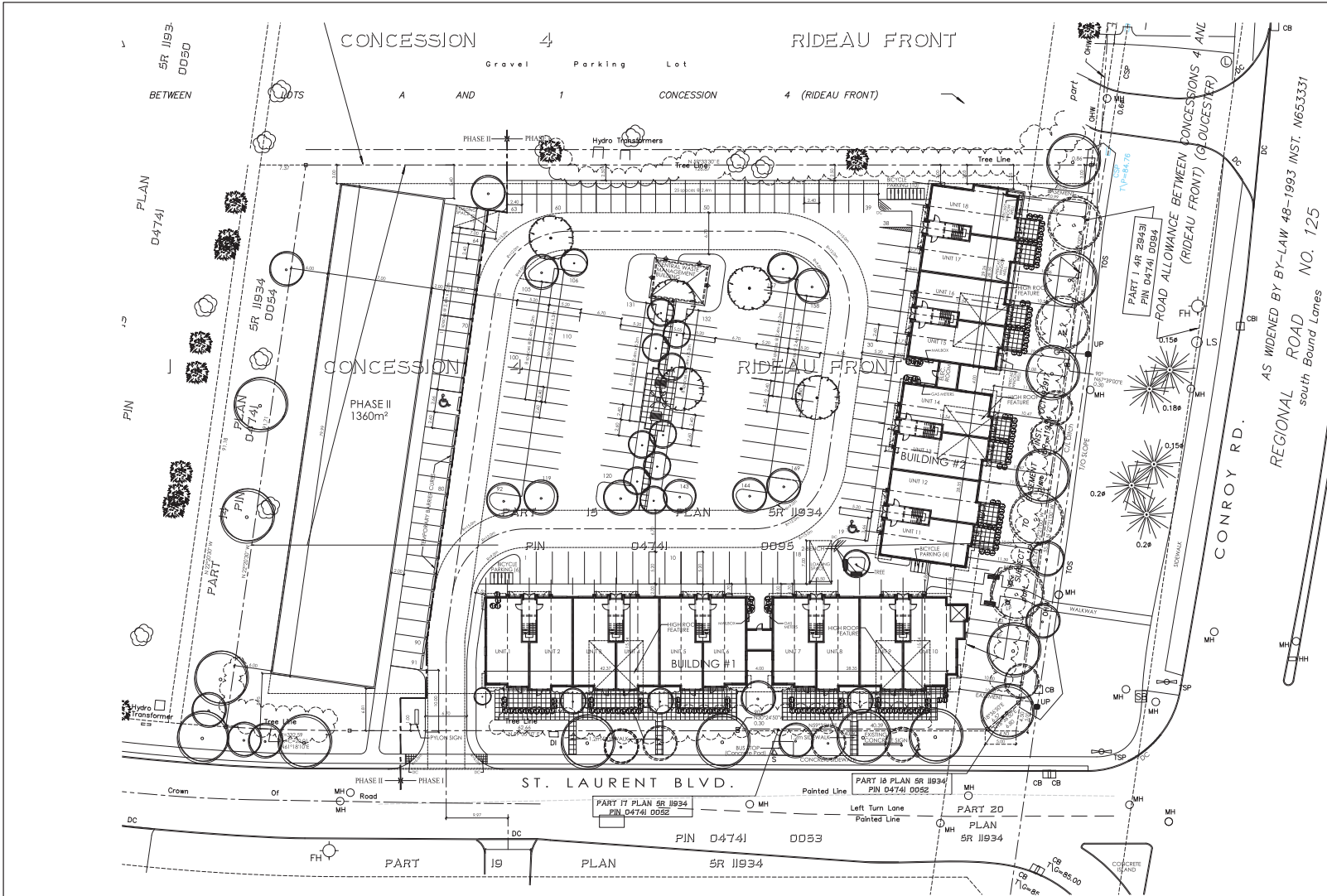

Figure 8 - Auto Trips generated at the Site during PM Peak Period





KEY PLAN: N15



ZONING INFORMATION

ZONING - IP (2103)	PROVIDED
MIN. LOT AREA - 750 m ²	11,619.99 m ²
MIN. LOT WIDTH - 0 m	92.16 m
MAX. LOT COVERAGE - 55%	27%
MIN. FRONT YARD DEPTH - 6.0 m	9.41 m
CORNER SIDE YARD DEPTH - 6.0 m	7.0 m
MIN. INTERIOR SIDE YARD	3.0 m
- ABUTTING RESIDENTIAL - 6.0m	
- ALL OTHER CASES - 3.0m	6.0m
MIN. REAR YARD DEPTH - 6.0 m	7.72 m
MAX. BUILDING HEIGHT	
- WITHIN 20m RESIDENTIAL - 11.0m	
- ALL OTHER CASES - 22.0m	
MIN. LANDSCAPE ABUTTING	
RESIDENTIAL - 3.0m	
STREET - 3.0m	
- OTHER - 0.0m	

[2103] - CONVENIENCE STORE PROHIBITED

BUILDING #1 UNITS 1 - 10 (G.F.A.)

GROUND FLOOR	999.97m ²
SECOND FLOOR	1,024.39m ²
TOTAL FLOOR AREA	2,024.36m ²

BUILDING #2 UNITS 11 - 18 (G.F.A.)

GROUND FLOOR	783.01m ²
SECOND FLOOR	892.69m ²
TOTAL FLOOR AREA	1,585.50m ²

PARKING REQUIRED PHASE I (2.4 SPACES/100m² OFFICE)
 3,609.86m² / 100m² = 36.10 x 2.4 = 86.64 SPACES

PARKING REQUIRED PHASE II (2.45 SPACES/100m² OFFICE)
 2720m² / 100m² = 27.2 x 2.4 = 65.28 SPACES

PARKING REQUIRED PHASE I & II
 6,329.86 m² / 100m² = 63.30 x 2.4 = 151.92 SPACES

PARKING PROVIDED
 SPACES @ 2.6m x 5.2m = 85 SPACES (50.3%)
 SPACES @ 2.4m x 5.2m = 84 SPACES (49.7%)
 TOTAL PARKING PROVIDED = 169 SPACES

LOADING SPACES REQUIRED = OFFICE (5,000.9,999 m² G.F.A.) = 2 SPACES
 LOADING SPACES PROVIDED = 2 SPACES

BICYCLE PARKING REQUIRED - 1/250m² G.F.A.
 PHASE I = 4,004.07m² / 250m² = 16.01 = 16 SPACES
 PHASE II BICYCLE PARKING PROVIDED = 20 SPACES

SITE INFORMATION DERIVED FROM SURVEYOR'S REAL PROPERTY REPORT
 PART 1 PLAN OF PART OF LOT 1
 CONCESSION 4 (RIDEAU FRONT)
 GEOGRAPHIC TOWNSHIP OF GLOUCESTER
 CITY OF OTTAWA
 PREPARED BY ANNIS, O'SULLIVAN, VOLLEBEK LTD.

SITE PLAN TO BE READ IN CONJUNCTION WITH LANDSCAPE PLAN PREPARED BY JAMES B. LENNOX AND ASSOCIATES INC.
 - SITE SERVICING & GRADING PLANS PREPARED BY EXP



M. David Blakely Architect Inc.
 2000 Prince of Wales Dr., Suite 101
 Ottawa, Ontario K2E 6T9
 Phone (613) 226-8811 Fax (613) 226-7942

GENERAL NOTES:

- THE CONTRACTOR IS RESPONSIBLE FOR CHECKING AND VERIFYING ALL DIMENSIONS AND OCCUPANCY LOADS BE REFERRED TO M. DAVID BLAKELY ARCHITECT INC.
- ALL WORK AND MATERIALS TO BE IN COMPLIANCE WITH ALL CODES, REGULATIONS, & BY-LAWS.
- ADDITIONAL DRAWINGS MAY BE ISSUED FOR:
 - CLARIFICATION TO ASSIST THE PROPOSER
 - EXERCISE OF WORK SUCH DRAWINGS WILL HAVE THE SAME MEANING AND INTENT AS IF THEY WERE INCLUDED WITH THE PLANS IN CONTRACT DOCUMENTS
 - DO NOT SCALE DRAWINGS.
- THIS DRAWING SHALL NOT BE USED OR COPIED WITHOUT THE AUTHORIZATION OF THE ARCHITECT
- THIS DRAWING SHALL NOT BE USED FOR PERMIT OR CONSTRUCTION UNLESS THE DRAWING BEARS THE ARCHITECT'S SEAL AND SIGNATURE
- THIS REPRODUCTION SHALL NOT BE ALTERED.



NO.	DATE	REVISIONS	BY	CHKD.
1	11/10/17	REMOVE BASEMENT LEVEL UNITS 15-18	JB	MD
2	12/06/17	LOADING SPACES ADDED	JB	MD
3	03/08/17	WINDOW WELLS ADDED UNITS 15-18	JB	MD
4	03/08/17	REVISED SIGN TRANSLATE DIMENSIONS	JB	MD
5	22/04/17	REVISED PER PRE-CONSULTATION MEETINGS	JB	MD
6	03/08/17	FOR REVIEW	JB	MD
7	29/03/17	REVISED PER SURVEY	JB	MD
8	08/09/16	FOR REVIEW	JB	MD
9	1/1/16	SECTION REVISIONS	MD	MD

PROJECT:
 CONROY BUSINESS PARK
 2500 ST. LAURENT BLVD.
 OTTAWA, ONTARIO

CLIENT:
 CONROY BUSINESS PARK Inc

DRAWING TITLE:
 SITE PLAN

DATE: MAR., 2017
SCALE: 1:300
SHEET NO.: SP-1

DRAWN BY: JB
CHECKED: MDB



DILLON
CONSULTING

LS GP INC.

Walkley Road Apartments

2190 Halifax Drive

Transportation Impact Assessment

Figure 12: Site Generated Traffic Volumes

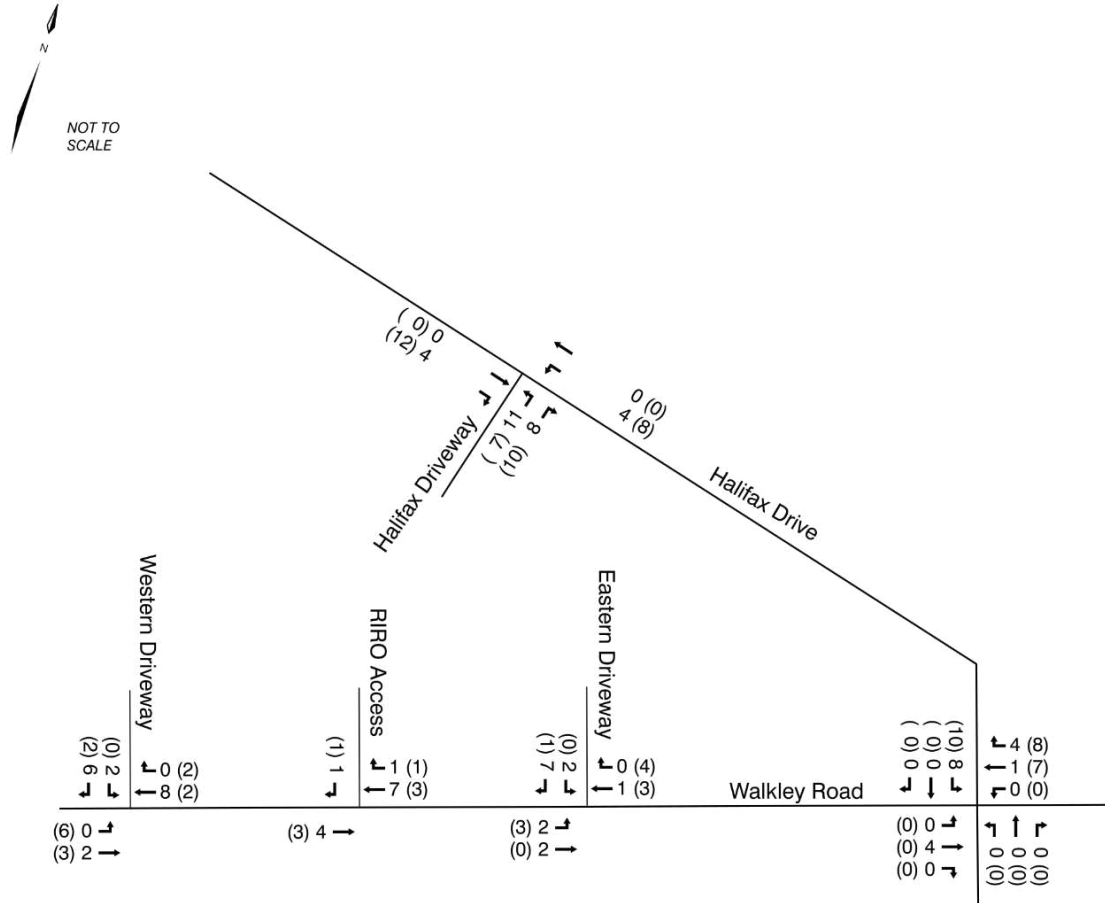

Legend:
 ↖ AM (PM)
 ← peak hour turning
 ↘ movement volumes

APPENDIX H

Strategic Long-Range Model and Intersection Growth Rate Figures

TRANS Regional Model

Version 2.15 - Assigned June 16, 2020

AM Peak Hour Total Traffic Volume

Walkley/Conroy area

2011 Model - Basecase

N/A

User Initials: TIMW

Plot Prepared: June, 2022

EMME Scenario: 21713



Legend

AM Peak Hour Total Traffic Volume

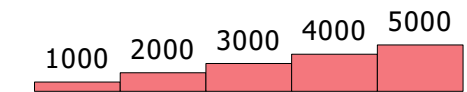

Distance (m)

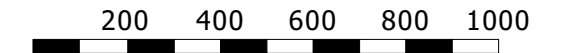

The TRANS model is continuously refined & maintained, and all information is provided in good faith. However, model outputs are provided "as is", and no warranty or guarantee is provided as to the accuracy, reliability or reasonableness of the results. In using this data, you agree to accept any and all risks arising from any incorrect, incomplete, or misleading information.

Recipients are required to use caution and professional judgement in using and interpreting model outputs. In particular, caution should be used when focusing on a geographically limited area (such as a single road or intersection), as the model is primarily designed to simulate regional-scale phenomena and has been calibrated at a regional level.

As general good practice, it is recommended that the user confirm the network coding within the area of interest, and compare base year forecasts against traffic count data to assess the extent to which the model may be over- or under-estimating the travel demand.

TRANS Regional Model

Version 2.15 - Assigned June 16, 2020

AM Peak Hour Total Traffic Volume

Walkley/Conroy Area

2031 Model - Basecase

N/A

User Initials: TIMW

Plot Prepared: June, 2022

EMME Scenario: 21715



Legend

AM Peak Hour Total Traffic Volume

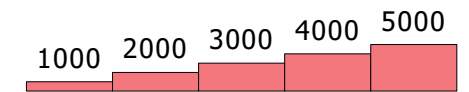

Distance (m)

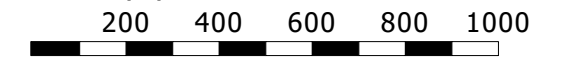

The TRANS model is continuously refined & maintained, and all information is provided in good faith. However, model outputs are provided "as is", and no warranty or guarantee is provided as to the accuracy, reliability or reasonableness of the results. In using this data, you agree to accept any and all risks arising from any incorrect, incomplete, or misleading information.

Recipients are required to use caution and professional judgement in using and interpreting model outputs. In particular, caution should be used when focusing on a geographically limited area (such as a single road or intersection), as the model is primarily designed to simulate regional-scale phenomena and has been calibrated at a regional level.

As a general good practice, it is recommended that the user confirm the network coding within the area of interest, and compare base year forecasts against traffic count data to assess the extent to which the model may be over- or under-estimating the travel demand.

INTERSECTION TRAFFIC GROWTH RATE, AM PEAK PERIOD

Total Vehicular Volume Entering the Intersection, 2000 to 2016

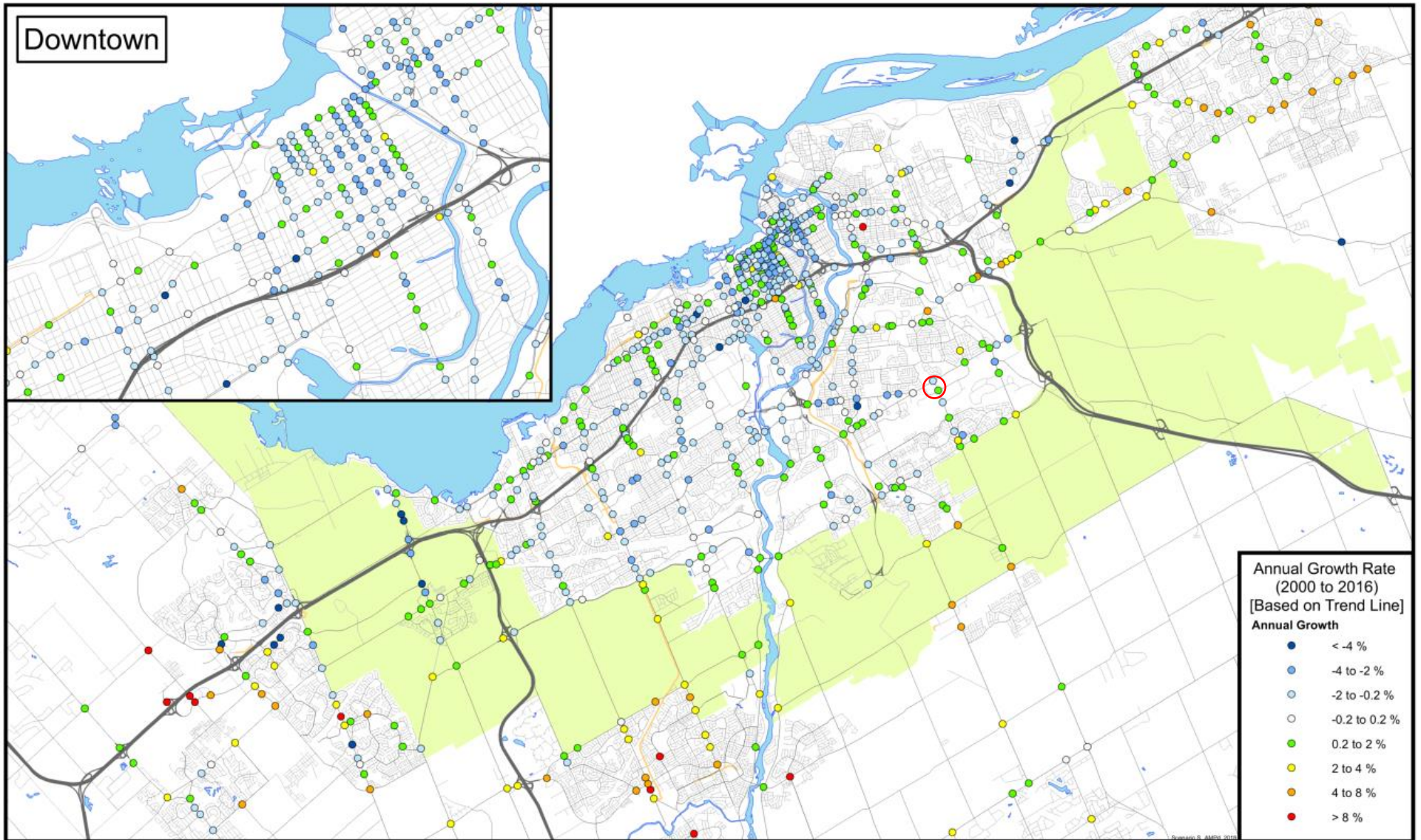

INTERSECTION TRAFFIC GROWTH RATE, PM PEAK PERIOD

Total Vehicular Volume Entering the Intersection, 2000 to 2016

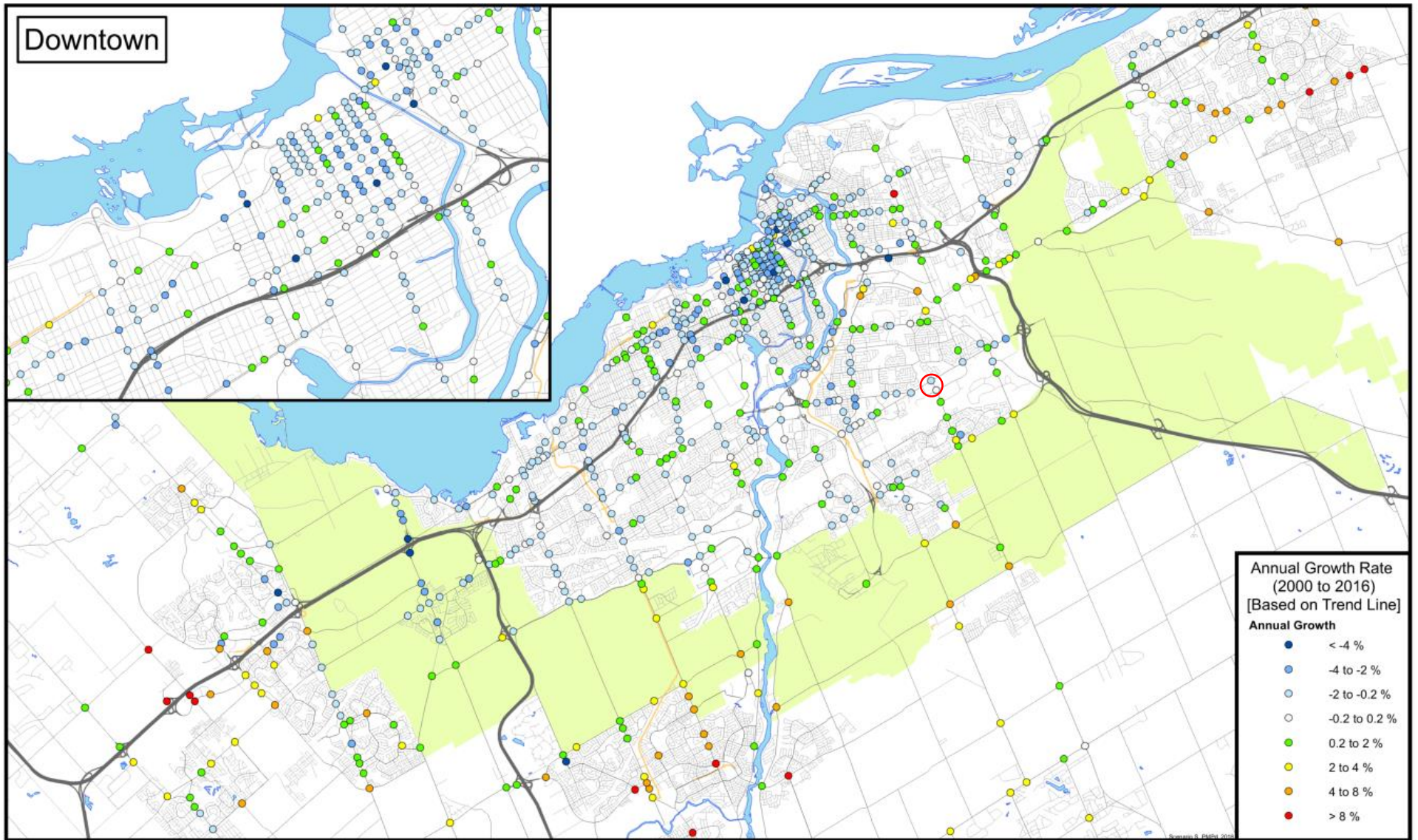

APPENDIX I

Signal Timing Plans

Traffic Signal Timing

City of Ottawa, Public Works Department

Traffic Signal Operations Unit

Intersection:	<u>Main: Walkley</u>	Side:	<u>Don Reid / Ryder</u>
Controller:	<u>MS 3200</u>	TSD:	<u>5424</u>
Author:	<u>Matthew Anderson</u>	Date:	<u>01-Jun-2022</u>

Existing Timing Plans[†]

	Plan					Ped Minimum Time		
	AM Peak 1	Off Peak 2	PM Peak 3	Night 4	Weekend 5	Walk	DW	A+R
Cycle	100	100	110	80	100			
Offset	94	20	20	30	38			
EB Thru	64	64	74	44	64	15	15	3.3+2.6
WB Thru	64	64	74	44	64	15	15	3.3+2.6
NB Thru	36	36	36	36	36	10	20	3.3+2.9
SB Thru	36	36	36	36	36	10	20	3.3+2.9

Phasing Sequence[‡]

Plan: All

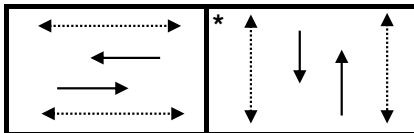

Schedule

Weekday

Time	Plan
0:15	4
6:30	1
9:30	2
15:00	3
18:30	2
21:30	4

Saturday

Time	Plan
0:15	4
6:30	2
11:00	5
19:30	2
22:00	4

Sunday

Time	Plan
0:15	4
6:30	2
21:00	4

Notes

†: Time for each direction includes amber and all red intervals

‡: Start of first phase should be used as reference point for offset

Asterisk (*) Indicates actuated phase

(fp): Fully Protected Left Turn

◄.....► Pedestrian signal

Cost is \$61.16 (\$54.12 + HST)

Traffic Signal Timing

City of Ottawa, Public Works Department

Traffic Signal Operations Unit

Intersection:	<i>Main:</i> Walkley	<i>Side:</i> 160m W of Conroy
Controller:	MS 3200	TSD: 6486
Author:	Matthew Anderson	Date: 01-Jun-2022

Existing Timing Plans†

	Plan					Ped Minimum Time		
	AM Peak 1	Off Peak 2	PM Peak 3	Night 4	Weekend 5	Walk	DW	A+R
Cycle	100	100	110	80	100			
Offset	88	20	25	X	16			
EB Thru	71	71	81	51	71	18	13	3.3+2.7
WB Thru	71	71	81	51	71	-	-	3.3+2.7
NB Thru	29	29	29	29	29	7	16	3.3+2.7

Phasing Sequence‡

Plan: All

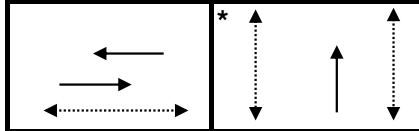

Schedule

Weekday

Time	Plan
0:15	4
6:30	1
9:30	2
15:00	3
18:30	2
21:30	4

Saturday

Time	Plan
0:15	4
6:30	2
11:00	5
19:30	2
22:00	4

Sunday

Time	Plan
0:15	4
6:30	2
21:00	4

Notes

†: Time for each direction includes amber and all red intervals

‡: Start of first phase should be used as reference point for offset

Asterisk (*) Indicates actuated phase

(fp): Fully Protected Left Turn

◀.....▶ Pedestrian signal

Cost is \$61.16 (\$54.12 + HST)

Traffic Signal Timing

City of Ottawa, Public Works Department

Traffic Signal Operations Unit

Intersection:	<i>Main:</i> Walkley	<i>Side:</i> Conroy
Controller:	MS 3200	TSD: 5612
Author:	Matthew Anderson	Date: 01-Jun-2022

Existing Timing Plans†

	Plan						Ped Minimum Time		
	Early AM	Off Peak	PM Peak	Night	Weekend	AM Peak	Walk	DW	A+R
	1	2	3	4	5	10			
Cycle	100	100	110	85	100	120			
Offset	90	47	20	X	18	43			
EB Thru	44	45	51	36	45	55	10	20	3.7+2.7
WB Thru	65	69	79	54	69	80	-	-	3.7+2.7
NB Left (fp)	35	31	31	31	31	40	7	17	3.7+2.7
WB Left (fp)	21	24	28	18	24	25	-	-	3.3+2.9

Phasing Sequence‡

Plan: All

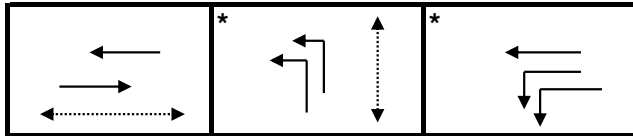

Schedule

Weekday

Time	Plan
0:15	4
6:30	1
7:00	10
9:30	2
15:00	3
18:30	2
21:30	4

Saturday

Time	Plan
0:15	4
6:30	2
11:00	5
19:30	2
22:00	4

Sunday

Time	Plan
0:15	4
6:30	2
21:00	4

Notes

†: Time for each direction includes amber and all red intervals

‡: Start of first phase should be used as reference point for offset

Asterisk (*) Indicates actuated phase

(fp): Fully Protected Left Turn

←.....→ Pedestrian signal

Cost is \$61.16 (\$54.12 + HST)

Traffic Signal Timing

City of Ottawa, Public Works Department

Traffic Signal Operations Unit

Intersection:	<i>Main:</i> Conroy	<i>Side:</i>	St. Laurent
Controller:	ATC 3	TSD:	5612
Author:	Matthew Anderson	Date:	01-Jun-2022

Existing Timing Plans†

	Plan					Ped Minimum Time		
	AM Peak 1	Off Peak 2	PM Peak 3	Night 4	Weekend 5	Walk	DW	A+R
Cycle	100	90	95	90	90			
Offset	23	50	2	X	50			
NB Thru	56	46	36	46	46	7	17	3.7+2.6
SB Thru	56	46	36	46	46	7	17	3.7+2.6
WB Left	-	-	15	-	-	-	-	3.3+2.4
EB Thru	44	44	44	44	44	7	30	3.3+3.6
WB Thru	44	44	59	44	44	7	30	3.3+3.6

Phasing Sequence‡

Plan: 1,2,4,5

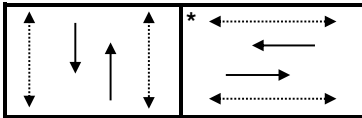

Plan: 3

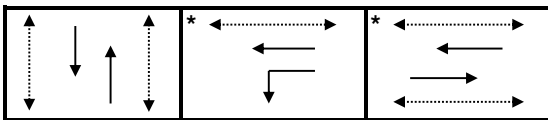

Schedule

Weekday		Saturday		Sunday	
Time	Plan	Time	Plan	Time	Plan
0:15	4	0:15	4	0:15	4
6:30	1	6:30	2	6:30	2
9:30	2	11:00	5	21:00	4
15:00	3	19:30	2		
18:30	2	22:00	4		
21:30	4				

Notes

- †: Time for each direction includes amber and all red intervals
- ‡: Start of first phase should be used as reference point for offset
- Asterisk (*) Indicates actuated phase
- (fp): Fully Protected Left Turn
- ◄.....► Pedestrian signal

Cost is \$61.16 (\$54.12 + HST)

APPENDIX J

Existing Synchro Analysis

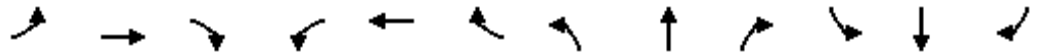

Lane Group	EBL	EBT	EBR	WBL	WBT	WBR	NBL	NBT	NBR	SBL	SBT	SBR
Lane Configurations												
Traffic Volume (vph)	29	918	144	36	1366	195	73	2	48	44	42	39
Future Volume (vph)	29	918	144	36	1366	195	73	2	48	44	42	39
Ideal Flow (vphpl)	1800	1800	1800	1800	1800	1800	1800	1800	1800	1800	1800	1800
Storage Length (m)	40.0		0.0	50.0		0.0	35.0		0.0	30.0		0.0
Storage Lanes	1		0	1		0	1		0	1		0
Taper Length (m)	25.0			30.0			25.0			30.0		
Lane Util. Factor	1.00	0.95	0.95	1.00	0.95	0.95	1.00	1.00	1.00	1.00	1.00	1.00
Ped Bike Factor		1.00		1.00	1.00		1.00	0.99			0.99	
Frt		0.980			0.981			0.855			0.928	
Flt Protected	0.950			0.950			0.950			0.950		
Satd. Flow (prot)	1537	3187	0	1642	3166	0	1580	1347	0	1674	1625	0
Flt Permitted	0.099			0.215			0.699			0.721		
Satd. Flow (perm)	160	3187	0	371	3166	0	1162	1347	0	1271	1625	0
Right Turn on Red			Yes			Yes			Yes			Yes
Satd. Flow (RTOR)		30			27			53			32	
Link Speed (k/h)		50			50			50			50	
Link Distance (m)		402.0			171.1			100.3			281.0	
Travel Time (s)		28.9			12.3			7.2			20.2	
Confl. Peds. (#/hr)	1		5	5		1	1					1
Confl. Bikes (#/hr)									1			
Peak Hour Factor	0.90	0.90	0.90	0.90	0.90	0.90	0.90	0.90	0.90	0.90	0.90	0.90
Heavy Vehicles (%)	10%	4%	1%	3%	5%	1%	7%	1%	12%	1%	1%	1%
Adj. Flow (vph)	32	1020	160	40	1518	217	81	2	53	49	47	43
Shared Lane Traffic (%)												
Lane Group Flow (vph)	32	1180	0	40	1735	0	81	55	0	49	90	0
Enter Blocked Intersection	No	No	No	No	No	No	No	No	No	No	No	No
Lane Alignment	L NA	Left	R NA	Left	Left	Right	L NA	Left	R NA	L NA	Left	R NA
Median Width(m)		5.0			5.0			3.5			3.5	
Link Offset(m)		0.0			0.0			0.0			0.0	
Crosswalk Width(m)		5.0			5.0			5.0			5.0	
Two way Left Turn Lane												
Headway Factor	1.09	1.09	1.09	1.09	1.09	1.09	1.09	1.09	1.09	1.09	1.09	1.09
Turning Speed (k/h)	24		14	24		14	24		14	24		14
Number of Detectors	1	2		1	2		1	2		1	2	
Detector Template	Left	Thru		Left	Thru		Left	Thru		Left	Thru	
Leading Detector (m)	6.1	30.5		6.1	30.5		6.1	30.5		6.1	30.5	
Trailing Detector (m)	0.0	0.0		0.0	0.0		0.0	0.0		0.0	0.0	
Detector 1 Position(m)	0.0	0.0		0.0	0.0		0.0	0.0		0.0	0.0	
Detector 1 Size(m)	6.1	1.8		6.1	1.8		6.1	1.8		6.1	1.8	
Detector 1 Type	Cl+Ex	Cl+Ex		Cl+Ex	Cl+Ex		Cl+Ex	Cl+Ex		Cl+Ex	Cl+Ex	
Detector 1 Channel												
Detector 1 Extend (s)	0.0	0.0		0.0	0.0		0.0	0.0		0.0	0.0	
Detector 1 Queue (s)	0.0	0.0		0.0	0.0		0.0	0.0		0.0	0.0	
Detector 1 Delay (s)	0.0	0.0		0.0	0.0		0.0	0.0		0.0	0.0	
Detector 2 Position(m)		28.7			28.7			28.7			28.7	
Detector 2 Size(m)		1.8			1.8			1.8			1.8	
Detector 2 Type		Cl+Ex			Cl+Ex			Cl+Ex			Cl+Ex	
Detector 2 Channel												
Detector 2 Extend (s)		0.0			0.0			0.0			0.0	
Turn Type	Perm	NA		Perm	NA		Perm	NA		Perm	NA	
Protected Phases		2			6			8			4	
Permitted Phases	2			6			8			4		
Detector Phase	2	2		6	6		8	8		4	4	

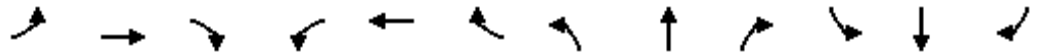

Lane Group	EBL	EBT	EBR	WBL	WBT	WBR	NBL	NBT	NBR	SBL	SBT	SBR
Switch Phase												
Minimum Initial (s)	10.0	10.0		10.0	10.0		10.0	10.0		10.0	10.0	
Minimum Split (s)	35.9	35.9		35.9	35.9		36.2	36.2		36.2	36.2	
Total Split (s)	64.0	64.0		64.0	64.0		36.0	36.0		36.0	36.0	
Total Split (%)	64.0%	64.0%		64.0%	64.0%		36.0%	36.0%		36.0%	36.0%	
Maximum Green (s)	58.1	58.1		58.1	58.1		29.8	29.8		29.8	29.8	
Yellow Time (s)	3.3	3.3		3.3	3.3		3.3	3.3		3.3	3.3	
All-Red Time (s)	2.6	2.6		2.6	2.6		2.9	2.9		2.9	2.9	
Lost Time Adjust (s)	0.0	0.0		0.0	0.0		0.0	0.0		0.0	0.0	
Total Lost Time (s)	5.9	5.9		5.9	5.9		6.2	6.2		6.2	6.2	
Lead/Lag												
Lead-Lag Optimize?												
Vehicle Extension (s)	3.0	3.0		3.0	3.0		3.0	3.0		3.0	3.0	
Recall Mode	C-Max	C-Max		C-Max	C-Max		None	None		None	None	
Walk Time (s)	15.0	15.0		15.0	15.0		10.0	10.0		10.0	10.0	
Flash Dont Walk (s)	15.0	15.0		15.0	15.0		20.0	20.0		20.0	20.0	
Pedestrian Calls (#/hr)	5	5		5	5		5	5		5	5	
Act Effct Green (s)	77.0	77.0		77.0	77.0		15.4	15.4		15.4	15.4	
Actuated g/C Ratio	0.77	0.77		0.77	0.77		0.15	0.15		0.15	0.15	
v/c Ratio	0.26	0.48		0.14	0.71		0.46	0.22		0.25	0.33	
Control Delay	14.9	7.3		5.6	6.9		44.5	11.1		37.4	26.1	
Queue Delay	0.0	0.0		0.0	0.0		0.0	0.0		0.0	0.0	
Total Delay	14.9	7.3		5.6	6.9		44.5	11.1		37.4	26.1	
LOS	B	A		A	A		D	B		D	C	
Approach Delay		7.5			6.9			31.0			30.1	
Approach LOS		A			A			C			C	
Queue Length 50th (m)	1.4	34.1		1.0	29.1		13.8	0.3		8.1	9.6	
Queue Length 95th (m)	10.9	85.7		m2.6	#193.0		22.0	8.1		14.4	18.2	
Internal Link Dist (m)		378.0			147.1			76.3			257.0	
Turn Bay Length (m)	40.0			50.0			35.0			30.0		
Base Capacity (vph)	123	2459		285	2442		346	438		378	506	
Starvation Cap Reductn	0	0		0	14		0	0		0	0	
Spillback Cap Reductn	0	0		0	0		0	0		0	0	
Storage Cap Reductn	0	0		0	0		0	0		0	0	
Reduced v/c Ratio	0.26	0.48		0.14	0.71		0.23	0.13		0.13	0.18	

Intersection Summary

Area Type: Other
 Cycle Length: 100
 Actuated Cycle Length: 100
 Offset: 94 (94%), Referenced to phase 2:EBTL and 6:WBTL, Start of Green
 Natural Cycle: 90
 Control Type: Actuated-Coordinated
 Maximum v/c Ratio: 0.71
 Intersection Signal Delay: 9.1
 Intersection LOS: A
 Intersection Capacity Utilization 67.4%
 ICU Level of Service C
 Analysis Period (min) 15
 # 95th percentile volume exceeds capacity, queue may be longer.
 Queue shown is maximum after two cycles.
 m Volume for 95th percentile queue is metered by upstream signal.

Splits and Phases: 1: Don Reid/Ryder & Walkley





Lane Group	EBT	EBR	WBL	WBT	NBL	NBR
Lane Configurations	↑↑	↑	↑	↑↑	↑	↑
Traffic Volume (vph)	929	90	74	1537	66	60
Future Volume (vph)	929	90	74	1537	66	60
Ideal Flow (vphpl)	1800	1800	1800	1800	1800	1800
Storage Length (m)		20.0	65.0		30.0	0.0
Storage Lanes		1	1		1	1
Taper Length (m)			25.0		30.0	
Lane Util. Factor	0.95	1.00	1.00	0.95	1.00	1.00
Ped Bike Factor		0.97	1.00			0.99
Fr _t		0.850				0.850
Fl _t Protected			0.950		0.950	
Satd. Flow (prot)	3221	1498	1674	3191	1674	1483
Fl _t Permitted			0.264		0.950	
Satd. Flow (perm)	3221	1459	465	3191	1674	1462
Right Turn on Red		Yes				Yes
Satd. Flow (RTOR)		73				67
Link Speed (k/h)	50			50	50	
Link Distance (m)	171.1			169.1	128.6	
Travel Time (s)	12.3			12.2	9.3	
Confl. Peds. (#/hr)		4	4			2
Peak Hour Factor	0.90	0.90	0.90	0.90	0.90	0.90
Heavy Vehicles (%)	5%	1%	1%	6%	1%	2%
Adj. Flow (vph)	1032	100	82	1708	73	67
Shared Lane Traffic (%)						
Lane Group Flow (vph)	1032	100	82	1708	73	67
Enter Blocked Intersection	No	No	No	No	No	No
Lane Alignment	Left	Right	L NA	Left	L NA	R NA
Median Width(m)	3.5			5.0	3.5	
Link Offset(m)	0.0			0.0	0.0	
Crosswalk Width(m)	5.0			5.0	5.0	
Two way Left Turn Lane						
Headway Factor	1.09	1.09	1.09	1.09	1.09	1.09
Turning Speed (k/h)		14	24		24	14
Number of Detectors	2	1	1	2	1	1
Detector Template	Thru	Right	Left	Thru	Left	Right
Leading Detector (m)	30.5	6.1	6.1	30.5	6.1	6.1
Trailing Detector (m)	0.0	0.0	0.0	0.0	0.0	0.0
Detector 1 Position(m)	0.0	0.0	0.0	0.0	0.0	0.0
Detector 1 Size(m)	1.8	6.1	6.1	1.8	6.1	6.1
Detector 1 Type	CI+Ex	CI+Ex	CI+Ex	CI+Ex	CI+Ex	CI+Ex
Detector 1 Channel						
Detector 1 Extend (s)	0.0	0.0	0.0	0.0	0.0	0.0
Detector 1 Queue (s)	0.0	0.0	0.0	0.0	0.0	0.0
Detector 1 Delay (s)	0.0	0.0	0.0	0.0	0.0	0.0
Detector 2 Position(m)	28.7			28.7		
Detector 2 Size(m)	1.8			1.8		
Detector 2 Type	CI+Ex			CI+Ex		
Detector 2 Channel						
Detector 2 Extend (s)	0.0			0.0		
Turn Type	NA	Perm	Perm	NA	Prot	Perm
Protected Phases	2			6	8	
Permitted Phases		2	6			8
Detector Phase	2	2	6	6	8	8
Switch Phase						

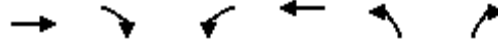

Lane Group	EBT	EBR	WBL	WBT	NBL	NBR
Minimum Initial (s)	10.0	10.0	10.0	10.0	5.0	5.0
Minimum Split (s)	37.0	37.0	37.0	37.0	29.0	29.0
Total Split (s)	71.0	71.0	71.0	71.0	29.0	29.0
Total Split (%)	71.0%	71.0%	71.0%	71.0%	29.0%	29.0%
Maximum Green (s)	65.0	65.0	65.0	65.0	23.0	23.0
Yellow Time (s)	3.3	3.3	3.3	3.3	3.3	3.3
All-Red Time (s)	2.7	2.7	2.7	2.7	2.7	2.7
Lost Time Adjust (s)	0.0	0.0	0.0	0.0	0.0	0.0
Total Lost Time (s)	6.0	6.0	6.0	6.0	6.0	6.0
Lead/Lag						
Lead-Lag Optimize?						
Vehicle Extension (s)	3.0	3.0	3.0	3.0	3.0	3.0
Recall Mode	C-Max	C-Max	C-Max	C-Max	None	None
Walk Time (s)	18.0	18.0			7.0	7.0
Flash Dont Walk (s)	13.0	13.0			16.0	16.0
Pedestrian Calls (#/hr)	5	5			5	5
Act Effct Green (s)	80.0	80.0	80.0	80.0	11.6	11.6
Actuated g/C Ratio	0.80	0.80	0.80	0.80	0.12	0.12
v/c Ratio	0.40	0.08	0.22	0.67	0.38	0.29
Control Delay	3.0	0.9	6.6	8.5	44.1	12.2
Queue Delay	0.0	0.0	0.0	0.5	0.0	0.0
Total Delay	3.0	0.9	6.6	9.1	44.1	12.2
LOS	A	A	A	A	D	B
Approach Delay	2.8			8.9	28.8	
Approach LOS	A			A	C	
Queue Length 50th (m)	16.6	0.3	3.0	59.1	12.5	0.0
Queue Length 95th (m)	22.2	1.1	13.0	140.2	21.3	9.6
Internal Link Dist (m)	147.1			145.1	104.6	
Turn Bay Length (m)		20.0	65.0		30.0	
Base Capacity (vph)	2576	1181	372	2552	385	387
Starvation Cap Reductn	0	0	0	405	0	0
Spillback Cap Reductn	0	0	0	73	0	0
Storage Cap Reductn	0	0	0	0	0	0
Reduced v/c Ratio	0.40	0.08	0.22	0.80	0.19	0.17

Intersection Summary

Area Type: Other
 Cycle Length: 100
 Actuated Cycle Length: 100
 Offset: 88 (88%), Referenced to phase 2:EBT and 6:WBTL, Start of Green
 Natural Cycle: 80
 Control Type: Actuated-Coordinated
 Maximum v/c Ratio: 0.67
 Intersection Signal Delay: 7.6
 Intersection Capacity Utilization 60.0%
 Analysis Period (min) 15
 Intersection LOS: A
 ICU Level of Service B

Splits and Phases: 2: 160m W of Conroy & Walkley





Lane Group	EBT	EBR	WBL	WBT	NBU	NBL	NBR
Lane Configurations	↑↑	↑	↑↑	↑↑		↑↑	↑
Traffic Volume (vph)	789	257	230	954	14	666	448
Future Volume (vph)	789	257	230	954	14	666	448
Ideal Flow (vphpl)	1800	1800	1800	1800	1800	1800	1800
Storage Length (m)		75.0	200.0			0.0	0.0
Storage Lanes		1	2			2	1
Taper Length (m)			50.0			10.0	
Lane Util. Factor	0.95	1.00	0.97	0.95	0.95	0.97	1.00
Ped Bike Factor		0.98	0.99				0.98
Fr _t		0.850					0.850
Fl _t Protected			0.950			0.950	
Satd. Flow (prot)	3161	1455	3066	3161	0	3186	1455
Fl _t Permitted			0.950			0.950	
Satd. Flow (perm)	3161	1419	3048	3161	0	3186	1430
Right Turn on Red		Yes					Yes
Satd. Flow (RTOR)		286					345
Link Speed (k/h)	50			50		60	
Link Distance (m)	169.1			271.7		348.5	
Travel Time (s)	12.2			19.6		20.9	
Confl. Peds. (#/hr)		10	10				3
Confl. Bikes (#/hr)		1					1
Peak Hour Factor	0.90	0.90	0.90	0.90	0.90	0.90	0.90
Heavy Vehicles (%)	7%	4%	7%	7%	2%	3%	4%
Adj. Flow (vph)	877	286	256	1060	16	740	498
Shared Lane Traffic (%)							
Lane Group Flow (vph)	877	286	256	1060	0	756	498
Enter Blocked Intersection	No	No	No	No	No	No	No
Lane Alignment	Left	R NA	Left	Left	R NA	L NA	R NA
Median Width(m)	7.0			9.0		10.5	
Link Offset(m)	0.0			0.0		0.0	
Crosswalk Width(m)	5.0			5.0		5.0	
Two way Left Turn Lane							
Headway Factor	1.09	1.09	1.09	1.09	1.09	1.09	1.09
Turning Speed (k/h)		14	24		14	24	14
Number of Detectors	2	1	1	2	1	1	1
Detector Template	Thru	Right	Left	Thru	Left	Left	Right
Leading Detector (m)	30.5	6.1	6.1	30.5	6.1	6.1	6.1
Trailing Detector (m)	0.0	0.0	0.0	0.0	0.0	0.0	0.0
Detector 1 Position(m)	0.0	0.0	0.0	0.0	0.0	0.0	0.0
Detector 1 Size(m)	1.8	6.1	6.1	1.8	6.1	6.1	6.1
Detector 1 Type	Cl+Ex	Cl+Ex	Cl+Ex	Cl+Ex	Cl+Ex	Cl+Ex	Cl+Ex
Detector 1 Channel							
Detector 1 Extend (s)	0.0	0.0	0.0	0.0	0.0	0.0	0.0
Detector 1 Queue (s)	0.0	0.0	0.0	0.0	0.0	0.0	0.0
Detector 1 Delay (s)	0.0	0.0	0.0	0.0	0.0	0.0	0.0
Detector 2 Position(m)	28.7			28.7			
Detector 2 Size(m)	1.8			1.8			
Detector 2 Type	Cl+Ex			Cl+Ex			
Detector 2 Channel							
Detector 2 Extend (s)	0.0			0.0			
Turn Type	NA	Perm	Prot	NA	Perm	Prot	Perm
Protected Phases	2		1	6		8	
Permitted Phases		2			8		8
Detector Phase	2	2	1	6	8	8	8



Lane Group	EBT	EBR	WBL	WBT	NBU	NBL	NBR
Switch Phase							
Minimum Initial (s)	10.0	10.0	5.0	10.0	5.0	5.0	5.0
Minimum Split (s)	36.4	36.4	16.0	24.7	30.4	30.4	30.4
Total Split (s)	55.0	55.0	25.0	80.0	40.0	40.0	40.0
Total Split (%)	45.8%	45.8%	20.8%	66.7%	33.3%	33.3%	33.3%
Maximum Green (s)	48.6	48.6	18.8	73.6	33.6	33.6	33.6
Yellow Time (s)	3.7	3.7	3.3	3.7	3.7	3.7	3.7
All-Red Time (s)	2.7	2.7	2.9	2.7	2.7	2.7	2.7
Lost Time Adjust (s)	0.0	0.0	0.0	0.0		0.0	0.0
Total Lost Time (s)	6.4	6.4	6.2	6.4		6.4	6.4
Lead/Lag	Lag	Lag	Lead				
Lead-Lag Optimize?	Yes	Yes	Yes				
Vehicle Extension (s)	3.0	3.0	3.0	3.0	3.0	3.0	3.0
Recall Mode	C-Max	C-Max	None	C-Max	None	None	None
Walk Time (s)	10.0	10.0			7.0	7.0	7.0
Flash Dont Walk (s)	20.0	20.0			17.0	17.0	17.0
Pedestrian Calls (#/hr)	10	10			5	5	5
Act Effct Green (s)	53.7	53.7	15.1	75.0		32.2	32.2
Actuated g/C Ratio	0.45	0.45	0.13	0.62		0.27	0.27
v/c Ratio	0.62	0.36	0.66	0.54		0.88	0.78
Control Delay	28.7	4.0	58.3	14.2		55.1	21.6
Queue Delay	0.0	0.0	0.0	0.0		0.0	0.0
Total Delay	28.7	4.0	58.3	14.2		55.1	21.6
LOS	C	A	E	B		E	C
Approach Delay	22.6			22.8		41.8	
Approach LOS	C			C		D	
Queue Length 50th (m)	76.8	0.0	27.6	66.0		79.8	30.5
Queue Length 95th (m)	102.3	14.9	38.9	81.9		#103.7	72.2
Internal Link Dist (m)	145.1			247.7		324.5	
Turn Bay Length (m)		75.0	200.0				
Base Capacity (vph)	1413	792	480	1974		892	648
Starvation Cap Reductn	0	0	0	0		0	0
Spillback Cap Reductn	0	0	0	0		0	0
Storage Cap Reductn	0	0	0	0		0	0
Reduced v/c Ratio	0.62	0.36	0.53	0.54		0.85	0.77

Intersection Summary

Area Type: Other
 Cycle Length: 120
 Actuated Cycle Length: 120
 Offset: 43 (36%), Referenced to phase 2:EBT and 6:WBT, Start of Green
 Natural Cycle: 85
 Control Type: Actuated-Coordinated
 Maximum v/c Ratio: 0.88
 Intersection Signal Delay: 29.1 Intersection LOS: C
 Intersection Capacity Utilization 68.2% ICU Level of Service C
 Analysis Period (min) 15
 # 95th percentile volume exceeds capacity, queue may be longer.
 Queue shown is maximum after two cycles.

Splits and Phases: 3: Conroy & Walkley



4: Conroy & St. Laurent
AM Peak Hour

2510 St. Laurent Boulevard
2022 Existing Traffic

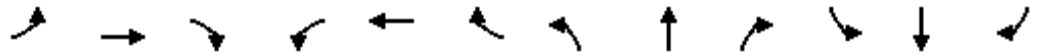

Lane Group	EBL	EBT	EBR	WBL	WBT	WBR	NBL	NBT	NBR	SBL	SBT	SBR
Lane Configurations												
Traffic Volume (vph)	4	59	76	60	38	39	177	1187	195	86	368	33
Future Volume (vph)	4	59	76	60	38	39	177	1187	195	86	368	33
Ideal Flow (vphpl)	1800	1800	1800	1800	1800	1800	1800	1800	1800	1800	1800	1800
Storage Length (m)	45.0		50.0	55.0		55.0	0.0		0.0	110.0		0.0
Storage Lanes	1		1	1		1	1		0	1		0
Taper Length (m)	40.0			40.0			10.0			25.0		
Lane Util. Factor	1.00	1.00	1.00	1.00	1.00	1.00	1.00	0.91	0.91	1.00	0.95	0.95
Ped Bike Factor	1.00		0.98	0.99		0.98	0.98	0.99		1.00	0.99	
Fr _t			0.850			0.850		0.979			0.988	
Fl _t Protected	0.950			0.950			0.950			0.950		
Satd. Flow (prot)	1353	1695	1427	1409	1589	1351	1642	4623	0	1674	3198	0
Fl _t Permitted	0.730			0.714			0.494			0.137		
Satd. Flow (perm)	1035	1695	1395	1049	1589	1328	841	4623	0	241	3198	0
Right Turn on Red			Yes			Yes			Yes			Yes
Satd. Flow (RTOR)			84			36						
Link Speed (k/h)		50			50			60			60	
Link Distance (m)		197.7			271.8			372.7			348.5	
Travel Time (s)		14.2			19.6			22.4			20.9	
Confl. Peds. (#/hr)	6		13	13		6	14		21	21		14
Confl. Bikes (#/hr)												25
Peak Hour Factor	0.90	0.90	0.90	0.90	0.90	0.90	0.90	0.90	0.90	0.90	0.90	0.90
Heavy Vehicles (%)	25%	5%	6%	20%	12%	12%	3%	2%	2%	1%	4%	3%
Adj. Flow (vph)	4	66	84	67	42	43	197	1319	217	96	409	37
Shared Lane Traffic (%)												
Lane Group Flow (vph)	4	66	84	67	42	43	197	1536	0	96	446	0
Enter Blocked Intersection	No	No	No	No	No	No	No	No	No	No	No	No
Lane Alignment	L NA	Left	R NA	L NA	Left	R NA	Left	Left	Right	L NA	Left	R NA
Median Width(m)		3.5			3.5			7.0			6.0	
Link Offset(m)		0.0			0.0			0.0			0.0	
Crosswalk Width(m)		5.0			5.0			5.0			5.0	
Two way Left Turn Lane												
Headway Factor	1.09	1.09	1.09	1.09	1.09	1.09	1.09	1.09	1.09	1.09	1.09	1.09
Turning Speed (k/h)	24		14	24		14	24		14	24		14
Number of Detectors	1	2	1	1	2	1	1	2		1	2	
Detector Template	Left	Thru	Right	Left	Thru	Right	Left	Thru		Left	Thru	
Leading Detector (m)	6.1	30.5	6.1	6.1	30.5	6.1	6.1	30.5		6.1	30.5	
Trailing Detector (m)	0.0	0.0	0.0	0.0	0.0	0.0	0.0	0.0		0.0	0.0	
Detector 1 Position(m)	0.0	0.0	0.0	0.0	0.0	0.0	0.0	0.0		0.0	0.0	
Detector 1 Size(m)	6.1	1.8	6.1	6.1	1.8	6.1	6.1	1.8		6.1	1.8	
Detector 1 Type	Cl+Ex	Cl+Ex	Cl+Ex	Cl+Ex	Cl+Ex	Cl+Ex	Cl+Ex	Cl+Ex		Cl+Ex	Cl+Ex	
Detector 1 Channel												
Detector 1 Extend (s)	0.0	0.0	0.0	0.0	0.0	0.0	0.0	0.0		0.0	0.0	
Detector 1 Queue (s)	0.0	0.0	0.0	0.0	0.0	0.0	0.0	0.0		0.0	0.0	
Detector 1 Delay (s)	0.0	0.0	0.0	0.0	0.0	0.0	0.0	0.0		0.0	0.0	
Detector 2 Position(m)		28.7			28.7			28.7			28.7	
Detector 2 Size(m)		1.8			1.8			1.8			1.8	
Detector 2 Type		Cl+Ex			Cl+Ex			Cl+Ex			Cl+Ex	
Detector 2 Channel												
Detector 2 Extend (s)		0.0			0.0			0.0			0.0	
Turn Type	Perm	NA	Perm	Perm	NA	Perm	Perm	NA		Perm	NA	
Protected Phases		4			8			2			6	
Permitted Phases	4		4	8		8	2			6		
Detector Phase	4	4	4	8	8	8	2	2		6	6	

4: Conroy & St. Laurent
AM Peak Hour

2510 St. Laurent Boulevard
2022 Existing Traffic

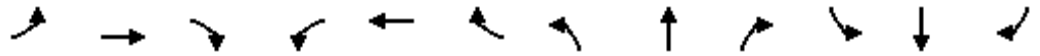









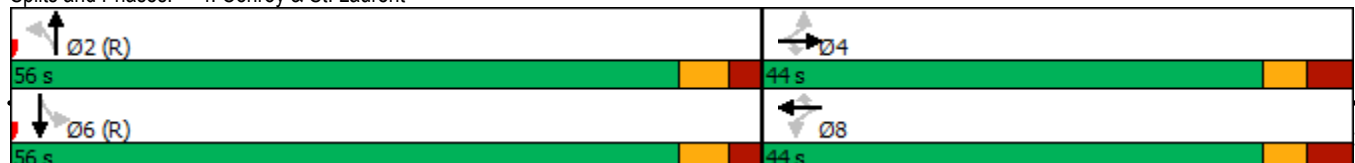

Lane Group	EBL	EBT	EBR	WBL	WBT	WBR	NBL	NBT	NBR	SBL	SBT	SBR
Switch Phase												
Minimum Initial (s)	10.0	10.0	10.0	10.0	10.0	10.0	10.0	10.0		10.0	10.0	
Minimum Split (s)	43.9	43.9	43.9	43.9	43.9	43.9	30.3	30.3		30.3	30.3	
Total Split (s)	44.0	44.0	44.0	44.0	44.0	44.0	56.0	56.0		56.0	56.0	
Total Split (%)	44.0%	44.0%	44.0%	44.0%	44.0%	44.0%	56.0%	56.0%		56.0%	56.0%	
Maximum Green (s)	37.1	37.1	37.1	37.1	37.1	37.1	49.7	49.7		49.7	49.7	
Yellow Time (s)	3.3	3.3	3.3	3.3	3.3	3.3	3.7	3.7		3.7	3.7	
All-Red Time (s)	3.6	3.6	3.6	3.6	3.6	3.6	2.6	2.6		2.6	2.6	
Lost Time Adjust (s)	0.0	0.0	0.0	0.0	0.0	0.0	0.0	0.0		0.0	0.0	
Total Lost Time (s)	6.9	6.9	6.9	6.9	6.9	6.9	6.3	6.3		6.3	6.3	
Lead/Lag												
Lead-Lag Optimize?												
Vehicle Extension (s)	3.0	3.0	3.0	3.0	3.0	3.0	3.0	3.0		3.0	3.0	
Recall Mode	None	None	None	None	None	None	C-Max	C-Max		C-Max	C-Max	
Walk Time (s)	7.0	7.0	7.0	7.0	7.0	7.0	7.0	7.0		7.0	7.0	
Flash Dont Walk (s)	30.0	30.0	30.0	30.0	30.0	30.0	17.0	17.0		17.0	17.0	
Pedestrian Calls (#/hr)	15	15	15	10	10	10	20	20		15	15	
Act Effct Green (s)	21.2	21.2	21.2	21.2	21.2	21.2	70.3	70.3		70.3	70.3	
Actuated g/C Ratio	0.21	0.21	0.21	0.21	0.21	0.21	0.70	0.70		0.70	0.70	
v/c Ratio	0.02	0.18	0.23	0.30	0.13	0.14	0.33	0.47		0.57	0.20	
Control Delay	22.2	28.6	6.9	32.3	27.3	10.1	13.3	11.0		34.4	8.9	
Queue Delay	0.0	0.0	0.0	0.0	0.0	0.0	0.0	0.0		0.0	0.0	
Total Delay	22.2	28.6	6.9	32.3	27.3	10.1	13.3	11.0		34.4	8.9	
LOS	C	C	A	C	C	B	B	B		C	A	
Approach Delay		16.6			24.6			11.2			13.4	
Approach LOS		B			C			B			B	
Queue Length 50th (m)	0.6	11.0	1.2	11.5	6.9	1.1	9.5	30.0		5.9	9.7	
Queue Length 95th (m)	m2.2	16.4	9.5	16.9	11.2	7.1	40.6	84.6		#42.6	31.8	
Internal Link Dist (m)		173.7			247.8			348.7			324.5	
Turn Bay Length (m)	45.0		50.0	55.0		55.0				110.0		
Base Capacity (vph)	383	628	570	389	589	515	590	3262		169	2251	
Starvation Cap Reductn	0	0	0	0	0	0	0	0		0	0	
Spillback Cap Reductn	0	0	0	0	0	0	0	0		0	0	
Storage Cap Reductn	0	0	0	0	0	0	0	0		0	0	
Reduced v/c Ratio	0.01	0.11	0.15	0.17	0.07	0.08	0.33	0.47		0.57	0.20	

Intersection Summary

Area Type: Other
 Cycle Length: 100
 Actuated Cycle Length: 100
 Offset: 23 (23%), Referenced to phase 2:NBT and 6:SBTL, Start of Green
 Natural Cycle: 100
 Control Type: Actuated-Coordinated
 Maximum v/c Ratio: 0.57
 Intersection Signal Delay: 12.8
 Intersection LOS: B
 Intersection Capacity Utilization 69.9%
 ICU Level of Service C
 Analysis Period (min) 15
 # 95th percentile volume exceeds capacity, queue may be longer.
 Queue shown is maximum after two cycles.
 m Volume for 95th percentile queue is metered by upstream signal.

Splits and Phases: 4: Conroy & St. Laurent



						
Lane Group	WBL	WBR	NBT	NBR	SBL	SBT
Lane Configurations						
Traffic Volume (vph)	75	40	71	24	69	176
Future Volume (vph)	75	40	71	24	69	176
Ideal Flow (vphpl)	1800	1800	1800	1800	1800	1800
Lane Util. Factor	1.00	1.00	1.00	1.00	1.00	1.00
Ped Bike Factor						
Frt	0.953		0.966			
Flt Protected	0.968					0.986
Satd. Flow (prot)	1563	0	1495	0	0	1678
Flt Permitted	0.968					0.986
Satd. Flow (perm)	1563	0	1495	0	0	1678
Link Speed (k/h)	50		50			50
Link Distance (m)	137.6		234.0			146.3
Travel Time (s)	9.9		16.8			10.5
Confl. Peds. (#/hr)				5	5	
Confl. Bikes (#/hr)		1				
Peak Hour Factor	0.90	0.90	0.90	0.90	0.90	0.90
Heavy Vehicles (%)	4%	7%	15%	15%	6%	4%
Adj. Flow (vph)	83	44	79	27	77	196
Shared Lane Traffic (%)						
Lane Group Flow (vph)	127	0	106	0	0	273
Enter Blocked Intersection	No	No	No	No	No	No
Lane Alignment	Left	Right	Left	Right	Left	Left
Median Width(m)	3.5		0.0			0.0
Link Offset(m)	0.0		0.0			0.0
Crosswalk Width(m)	2.0		10.0			10.0
Two way Left Turn Lane						
Headway Factor	1.09	1.09	1.09	1.09	1.09	1.09
Turning Speed (k/h)	24	14		14	24	
Sign Control	Stop		Free			Free
Intersection Summary						
Area Type:	Other					
Control Type:	Unsignalized					
Intersection Capacity Utilization	34.1%			ICU Level of Service A		
Analysis Period (min)	15					

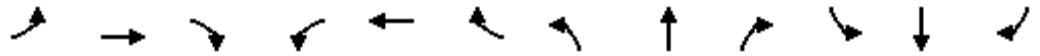

Lane Group	EBL	EBT	EBR	WBL	WBT	WBR	NBL	NBT	NBR	SBL	SBT	SBR
Lane Configurations												
Traffic Volume (vph)	27	1369	95	13	1400	70	137	0	65	87	99	50
Future Volume (vph)	27	1369	95	13	1400	70	137	0	65	87	99	50
Ideal Flow (vphpl)	1800	1800	1800	1800	1800	1800	1800	1800	1800	1800	1800	1800
Storage Length (m)	40.0		0.0	50.0		0.0	35.0		0.0	30.0		0.0
Storage Lanes	1		0	1		0	1		0	1		0
Taper Length (m)	25.0			30.0			25.0			30.0		
Lane Util. Factor	1.00	0.95	0.95	1.00	0.95	0.95	1.00	1.00	1.00	1.00	1.00	1.00
Ped Bike Factor		1.00			1.00		1.00				1.00	
Frt		0.990			0.993			0.850			0.949	
Flt Protected	0.950			0.950			0.950			0.950		
Satd. Flow (prot)	1674	3242	0	1674	3291	0	1674	1483	0	1674	1648	0
Flt Permitted	0.104			0.105			0.562			0.710		
Satd. Flow (perm)	183	3242	0	185	3291	0	989	1483	0	1251	1648	0
Right Turn on Red			Yes			Yes			Yes			Yes
Satd. Flow (RTOR)		12			9			38			23	
Link Speed (k/h)		50			50			50			50	
Link Distance (m)		402.0			171.1			100.3			281.0	
Travel Time (s)		28.9			12.3			7.2			20.2	
Confl. Peds. (#/hr)	1		10	10		1	2					2
Confl. Bikes (#/hr)			1									
Peak Hour Factor	0.90	0.90	0.90	0.90	0.90	0.90	0.90	0.90	0.90	0.90	0.90	0.90
Heavy Vehicles (%)	1%	3%	3%	1%	2%	1%	1%	1%	2%	1%	1%	4%
Adj. Flow (vph)	30	1521	106	14	1556	78	152	0	72	97	110	56
Shared Lane Traffic (%)												
Lane Group Flow (vph)	30	1627	0	14	1634	0	152	72	0	97	166	0
Enter Blocked Intersection	No	No	No	No	No	No	No	No	No	No	No	No
Lane Alignment	L NA	Left	R NA	Left	Left	Right	L NA	Left	R NA	L NA	Left	R NA
Median Width(m)		5.0			5.0			3.5			3.5	
Link Offset(m)		0.0			0.0			0.0			0.0	
Crosswalk Width(m)		5.0			5.0			5.0			5.0	
Two way Left Turn Lane												
Headway Factor	1.09	1.09	1.09	1.09	1.09	1.09	1.09	1.09	1.09	1.09	1.09	1.09
Turning Speed (k/h)	24		14	24		14	24		14	24		14
Number of Detectors	1	2		1	2		1	2		1	2	
Detector Template	Left	Thru		Left	Thru		Left	Thru		Left	Thru	
Leading Detector (m)	6.1	30.5		6.1	30.5		6.1	30.5		6.1	30.5	
Trailing Detector (m)	0.0	0.0		0.0	0.0		0.0	0.0		0.0	0.0	
Detector 1 Position(m)	0.0	0.0		0.0	0.0		0.0	0.0		0.0	0.0	
Detector 1 Size(m)	6.1	1.8		6.1	1.8		6.1	1.8		6.1	1.8	
Detector 1 Type	Cl+Ex	Cl+Ex		Cl+Ex	Cl+Ex		Cl+Ex	Cl+Ex		Cl+Ex	Cl+Ex	
Detector 1 Channel												
Detector 1 Extend (s)	0.0	0.0		0.0	0.0		0.0	0.0		0.0	0.0	
Detector 1 Queue (s)	0.0	0.0		0.0	0.0		0.0	0.0		0.0	0.0	
Detector 1 Delay (s)	0.0	0.0		0.0	0.0		0.0	0.0		0.0	0.0	
Detector 2 Position(m)		28.7			28.7			28.7			28.7	
Detector 2 Size(m)		1.8			1.8			1.8			1.8	
Detector 2 Type		Cl+Ex			Cl+Ex			Cl+Ex			Cl+Ex	
Detector 2 Channel												
Detector 2 Extend (s)		0.0			0.0			0.0			0.0	
Turn Type	Perm	NA		Perm	NA		Perm	NA		Perm	NA	
Protected Phases		2			6			8			4	
Permitted Phases	2			6			8			4		
Detector Phase	2	2		6	6		8	8		4	4	

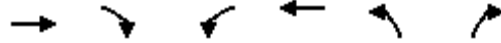

Lane Group	EBT	EBR	WBL	WBT	NBL	NBR
Lane Configurations	↑↑	↑	↑	↑↑	↑	↑
Traffic Volume (vph)	1532	64	36	1418	49	41
Future Volume (vph)	1532	64	36	1418	49	41
Ideal Flow (vphpl)	1800	1800	1800	1800	1800	1800
Storage Length (m)		20.0	65.0		30.0	0.0
Storage Lanes		1	1		1	1
Taper Length (m)			25.0		30.0	
Lane Util. Factor	0.95	1.00	1.00	0.95	1.00	1.00
Ped Bike Factor		0.97	1.00			0.99
Fr _t		0.850				0.850
Fl _t Protected			0.950		0.950	
Satd. Flow (prot)	3252	1483	1642	3316	1658	1483
Fl _t Permitted			0.116		0.950	
Satd. Flow (perm)	3252	1441	200	3316	1658	1463
Right Turn on Red		Yes				Yes
Satd. Flow (RTOR)		31				37
Link Speed (k/h)	50			50	50	
Link Distance (m)	171.1			169.1	128.6	
Travel Time (s)	12.3			12.2	9.3	
Confl. Peds. (#/hr)		5	5			1
Peak Hour Factor	0.90	0.90	0.90	0.90	0.90	0.90
Heavy Vehicles (%)	4%	2%	3%	2%	2%	2%
Adj. Flow (vph)	1702	71	40	1576	54	46
Shared Lane Traffic (%)						
Lane Group Flow (vph)	1702	71	40	1576	54	46
Enter Blocked Intersection	No	No	No	No	No	No
Lane Alignment	Left	Right	L NA	Left	L NA	R NA
Median Width(m)	3.5			5.0	3.5	
Link Offset(m)	0.0			0.0	0.0	
Crosswalk Width(m)	5.0			5.0	5.0	
Two way Left Turn Lane						
Headway Factor	1.09	1.09	1.09	1.09	1.09	1.09
Turning Speed (k/h)		14	24		24	14
Number of Detectors	2	1	1	2	1	1
Detector Template	Thru	Right	Left	Thru	Left	Right
Leading Detector (m)	30.5	6.1	6.1	30.5	6.1	6.1
Trailing Detector (m)	0.0	0.0	0.0	0.0	0.0	0.0
Detector 1 Position(m)	0.0	0.0	0.0	0.0	0.0	0.0
Detector 1 Size(m)	1.8	6.1	6.1	1.8	6.1	6.1
Detector 1 Type	CI+Ex	CI+Ex	CI+Ex	CI+Ex	CI+Ex	CI+Ex
Detector 1 Channel						
Detector 1 Extend (s)	0.0	0.0	0.0	0.0	0.0	0.0
Detector 1 Queue (s)	0.0	0.0	0.0	0.0	0.0	0.0
Detector 1 Delay (s)	0.0	0.0	0.0	0.0	0.0	0.0
Detector 2 Position(m)	28.7			28.7		
Detector 2 Size(m)	1.8			1.8		
Detector 2 Type	CI+Ex			CI+Ex		
Detector 2 Channel						
Detector 2 Extend (s)	0.0			0.0		
Turn Type	NA	Perm	Perm	NA	Prot	Perm
Protected Phases	2			6	8	
Permitted Phases		2	6			8
Detector Phase	2	2	6	6	8	8
Switch Phase						



Lane Group	EBT	EBR	WBL	WBT	NBL	NBR
Minimum Initial (s)	10.0	10.0	10.0	10.0	5.0	5.0
Minimum Split (s)	37.0	37.0	37.0	37.0	29.0	29.0
Total Split (s)	81.0	81.0	81.0	81.0	29.0	29.0
Total Split (%)	73.6%	73.6%	73.6%	73.6%	26.4%	26.4%
Maximum Green (s)	75.0	75.0	75.0	75.0	23.0	23.0
Yellow Time (s)	3.3	3.3	3.3	3.3	3.3	3.3
All-Red Time (s)	2.7	2.7	2.7	2.7	2.7	2.7
Lost Time Adjust (s)	0.0	0.0	0.0	0.0	0.0	0.0
Total Lost Time (s)	6.0	6.0	6.0	6.0	6.0	6.0
Lead/Lag						
Lead-Lag Optimize?						
Vehicle Extension (s)	3.0	3.0	3.0	3.0	3.0	3.0
Recall Mode	C-Max	C-Max	C-Max	C-Max	None	None
Walk Time (s)	18.0	18.0			7.0	7.0
Flash Dont Walk (s)	13.0	13.0			16.0	16.0
Pedestrian Calls (#/hr)	5	5			5	5
Act Effct Green (s)	90.4	90.4	90.4	90.4	11.1	11.1
Actuated g/C Ratio	0.82	0.82	0.82	0.82	0.10	0.10
v/c Ratio	0.64	0.06	0.24	0.58	0.33	0.26
Control Delay	2.2	0.8	10.1	7.5	48.5	19.9
Queue Delay	0.1	0.0	0.0	0.1	0.0	0.0
Total Delay	2.3	0.8	10.1	7.7	48.5	19.9
LOS	A	A	B	A	D	B
Approach Delay	2.3			7.7	35.3	
Approach LOS	A			A	D	
Queue Length 50th (m)	16.4	0.3	0.8	70.3	10.3	1.7
Queue Length 95th (m)	22.8	m0.8	m9.0	130.1	18.8	10.2
Internal Link Dist (m)	147.1			145.1	104.6	
Turn Bay Length (m)		20.0	65.0		30.0	
Base Capacity (vph)	2673	1190	164	2725	346	335
Starvation Cap Reductn	85	0	0	283	0	0
Spillback Cap Reductn	125	0	0	0	0	1
Storage Cap Reductn	0	0	0	0	0	0
Reduced v/c Ratio	0.67	0.06	0.24	0.65	0.16	0.14

Intersection Summary

Area Type: Other
 Cycle Length: 110
 Actuated Cycle Length: 110
 Offset: 25 (23%), Referenced to phase 2:EBT and 6:WBTL, Start of Green
 Natural Cycle: 80
 Control Type: Actuated-Coordinated
 Maximum v/c Ratio: 0.64
 Intersection Signal Delay: 5.7
 Intersection Capacity Utilization 59.4%
 Analysis Period (min) 15
 m Volume for 95th percentile queue is metered by upstream signal.

Splits and Phases: 2: 160m W of Conroy & Walkley



	→	↘	↙	←	↖	↗	↘
Lane Group	EBT	EBR	WBL	WBT	NBU	NBL	NBR
Lane Configurations	↑↑	↗	↘↘	↑↑		↘↘	↗
Traffic Volume (vph)	1139	438	522	965	42	457	297
Future Volume (vph)	1139	438	522	965	42	457	297
Ideal Flow (vphpl)	1800	1800	1800	1800	1800	1800	1800
Storage Length (m)		75.0	200.0			0.0	0.0
Storage Lanes		1	2			2	1
Taper Length (m)			50.0			10.0	
Lane Util. Factor	0.95	1.00	0.97	0.95	0.95	0.97	1.00
Ped Bike Factor		0.96	0.99				0.97
Fr _t		0.850					0.850
Fl _t Protected			0.950			0.950	
Satd. Flow (prot)	3221	1483	3185	3349	0	3248	1469
Fl _t Permitted			0.950			0.950	
Satd. Flow (perm)	3221	1430	3163	3349	0	3248	1418
Right Turn on Red		Yes					Yes
Satd. Flow (RTOR)		452					330
Link Speed (k/h)	50			50		60	
Link Distance (m)	169.1			271.7		348.5	
Travel Time (s)	12.2			19.6		20.9	
Confl. Peds. (#/hr)		22	22				16
Confl. Bikes (#/hr)		1					1
Peak Hour Factor	0.90	0.90	0.90	0.90	0.90	0.90	0.90
Heavy Vehicles (%)	5%	2%	3%	1%	1%	1%	3%
Adj. Flow (vph)	1266	487	580	1072	47	508	330
Shared Lane Traffic (%)							
Lane Group Flow (vph)	1266	487	580	1072	0	555	330
Enter Blocked Intersection	No	No	No	No	No	No	No
Lane Alignment	Left	R NA	Left	Left	R NA	L NA	R NA
Median Width(m)	7.0			9.0		10.5	
Link Offset(m)	0.0			0.0		0.0	
Crosswalk Width(m)	5.0			5.0		5.0	
Two way Left Turn Lane							
Headway Factor	1.09	1.09	1.09	1.09	1.09	1.09	1.09
Turning Speed (k/h)		14	24		14	24	14
Number of Detectors	2	1	1	2	1	1	1
Detector Template	Thru	Right	Left	Thru	Left	Left	Right
Leading Detector (m)	30.5	6.1	6.1	30.5	6.1	6.1	6.1
Trailing Detector (m)	0.0	0.0	0.0	0.0	0.0	0.0	0.0
Detector 1 Position(m)	0.0	0.0	0.0	0.0	0.0	0.0	0.0
Detector 1 Size(m)	1.8	6.1	6.1	1.8	6.1	6.1	6.1
Detector 1 Type	Cl+Ex	Cl+Ex	Cl+Ex	Cl+Ex	Cl+Ex	Cl+Ex	Cl+Ex
Detector 1 Channel							
Detector 1 Extend (s)	0.0	0.0	0.0	0.0	0.0	0.0	0.0
Detector 1 Queue (s)	0.0	0.0	0.0	0.0	0.0	0.0	0.0
Detector 1 Delay (s)	0.0	0.0	0.0	0.0	0.0	0.0	0.0
Detector 2 Position(m)	28.7			28.7			
Detector 2 Size(m)	1.8			1.8			
Detector 2 Type	Cl+Ex			Cl+Ex			
Detector 2 Channel							
Detector 2 Extend (s)	0.0			0.0			
Turn Type	NA	Perm	Prot	NA	Perm	Prot	Perm
Protected Phases	2		1	6		8	
Permitted Phases		2			8		8
Detector Phase	2	2	1	6	8	8	8



Lane Group	EBT	EBR	WBL	WBT	NBU	NBL	NBR
Switch Phase							
Minimum Initial (s)	10.0	10.0	5.0	10.0	5.0	5.0	5.0
Minimum Split (s)	36.4	36.4	16.0	24.7	30.4	30.4	30.4
Total Split (s)	51.0	51.0	28.0	79.0	31.0	31.0	31.0
Total Split (%)	46.4%	46.4%	25.5%	71.8%	28.2%	28.2%	28.2%
Maximum Green (s)	44.6	44.6	21.8	72.6	24.6	24.6	24.6
Yellow Time (s)	3.7	3.7	3.3	3.7	3.7	3.7	3.7
All-Red Time (s)	2.7	2.7	2.9	2.7	2.7	2.7	2.7
Lost Time Adjust (s)	0.0	0.0	0.0	0.0		0.0	0.0
Total Lost Time (s)	6.4	6.4	6.2	6.4		6.4	6.4
Lead/Lag	Lag	Lag	Lead				
Lead-Lag Optimize?	Yes	Yes	Yes				
Vehicle Extension (s)	3.0	3.0	3.0	3.0	3.0	3.0	3.0
Recall Mode	C-Max	C-Max	None	C-Max	None	None	None
Walk Time (s)	10.0	10.0			7.0	7.0	7.0
Flash Dont Walk (s)	20.0	20.0			17.0	17.0	17.0
Pedestrian Calls (#/hr)	20	20			15	15	15
Act Effct Green (s)	46.1	46.1	22.0	74.3		22.9	22.9
Actuated g/C Ratio	0.42	0.42	0.20	0.68		0.21	0.21
v/c Ratio	0.94	0.57	0.91	0.47		0.82	0.59
Control Delay	40.6	7.6	62.9	9.6		52.5	8.8
Queue Delay	0.0	0.2	0.0	0.0		0.0	0.0
Total Delay	40.6	7.8	62.9	9.6		52.5	8.8
LOS	D	A	E	A		D	A
Approach Delay	31.5			28.3		36.2	
Approach LOS	C			C		D	
Queue Length 50th (m)	89.4	0.0	58.4	50.7		53.3	0.0
Queue Length 95th (m)	#169.0	39.9	#87.2	63.4		70.9	21.8
Internal Link Dist (m)	145.1			247.7		324.5	
Turn Bay Length (m)		75.0	200.0				
Base Capacity (vph)	1349	861	644	2263		726	573
Starvation Cap Reductn	0	57	0	0		0	0
Spillback Cap Reductn	0	0	0	42		0	0
Storage Cap Reductn	0	0	0	0		0	0
Reduced v/c Ratio	0.94	0.61	0.90	0.48		0.76	0.58

Intersection Summary

Area Type: Other
 Cycle Length: 110
 Actuated Cycle Length: 110
 Offset: 20 (18%), Referenced to phase 2:EBT and 6:WBT, Start of Green
 Natural Cycle: 95
 Control Type: Actuated-Coordinated
 Maximum v/c Ratio: 0.94
 Intersection Signal Delay: 31.2 Intersection LOS: C
 Intersection Capacity Utilization 81.9% ICU Level of Service D
 Analysis Period (min) 15
 # 95th percentile volume exceeds capacity, queue may be longer.
 Queue shown is maximum after two cycles.

Splits and Phases: 3: Conroy & Walkley



4: Conroy & St. Laurent
PM Peak Hour

2510 St. Laurent Boulevard
2022 Existing Traffic

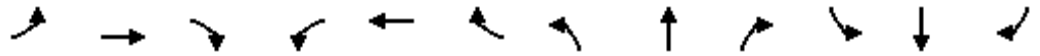

Lane Group	EBL	EBT	EBR	WBL	WBT	WBR	NBL	NBT	NBR	SBL	SBT	SBR
Lane Configurations												
Traffic Volume (vph)	17	67	306	222	28	105	35	564	79	37	1064	8
Future Volume (vph)	17	67	306	222	28	105	35	564	79	37	1064	8
Ideal Flow (vphpl)	1800	1800	1800	1800	1800	1800	1800	1800	1800	1800	1800	1800
Storage Length (m)	45.0		50.0	55.0		55.0	0.0		0.0	110.0		0.0
Storage Lanes	1		1	1		1	1		0	1		0
Taper Length (m)	40.0			40.0			10.0			25.0		
Lane Util. Factor	1.00	1.00	1.00	1.00	1.00	1.00	1.00	0.91	0.91	1.00	0.95	0.95
Ped Bike Factor	1.00		0.98	1.00		0.99		0.99		0.99	1.00	
Frt			0.850			0.850		0.982			0.999	
Flt Protected	0.950			0.950			0.950			0.950		
Satd. Flow (prot)	1674	1728	1483	1642	1618	1483	1642	4617	0	1537	3309	0
Flt Permitted	0.737			0.565			0.127			0.349		
Satd. Flow (perm)	1297	1728	1461	974	1618	1463	219	4617	0	560	3309	0
Right Turn on Red			Yes			Yes			Yes			Yes
Satd. Flow (RTOR)			115			68		28			1	
Link Speed (k/h)		50			50			60			60	
Link Distance (m)		197.7			271.8			372.7			348.5	
Travel Time (s)		14.2			19.6			22.4			20.9	
Confl. Peds. (#/hr)	2		4	4		2	8		12	12		8
Confl. Bikes (#/hr)									4			11
Peak Hour Factor	0.90	0.90	0.90	0.90	0.90	0.90	0.90	0.90	0.90	0.90	0.90	0.90
Heavy Vehicles (%)	1%	3%	2%	3%	10%	2%	3%	2%	8%	10%	2%	12%
Adj. Flow (vph)	19	74	340	247	31	117	39	627	88	41	1182	9
Shared Lane Traffic (%)												
Lane Group Flow (vph)	19	74	340	247	31	117	39	715	0	41	1191	0
Enter Blocked Intersection	No	No	No	No	No	No	No	No	No	No	No	No
Lane Alignment	L NA	Left	R NA	L NA	Left	R NA	Left	Left	Right	L NA	Left	R NA
Median Width(m)		3.5			3.5			7.0			6.0	
Link Offset(m)		0.0			0.0			0.0			0.0	
Crosswalk Width(m)		5.0			5.0			5.0			5.0	
Two way Left Turn Lane												
Headway Factor	1.09	1.09	1.09	1.09	1.09	1.09	1.09	1.09	1.09	1.09	1.09	1.09
Turning Speed (k/h)	24		14	24		14	24		14	24		14
Number of Detectors	1	2	1	1	2	1	1	2		1	2	
Detector Template	Left	Thru	Right	Left	Thru	Right	Left	Thru		Left	Thru	
Leading Detector (m)	6.1	30.5	6.1	6.1	30.5	6.1	6.1	30.5		6.1	30.5	
Trailing Detector (m)	0.0	0.0	0.0	0.0	0.0	0.0	0.0	0.0		0.0	0.0	
Detector 1 Position(m)	0.0	0.0	0.0	0.0	0.0	0.0	0.0	0.0		0.0	0.0	
Detector 1 Size(m)	6.1	1.8	6.1	6.1	1.8	6.1	6.1	1.8		6.1	1.8	
Detector 1 Type	Cl+Ex	Cl+Ex	Cl+Ex	Cl+Ex	Cl+Ex	Cl+Ex	Cl+Ex	Cl+Ex		Cl+Ex	Cl+Ex	
Detector 1 Channel												
Detector 1 Extend (s)	0.0	0.0	0.0	0.0	0.0	0.0	0.0	0.0		0.0	0.0	
Detector 1 Queue (s)	0.0	0.0	0.0	0.0	0.0	0.0	0.0	0.0		0.0	0.0	
Detector 1 Delay (s)	0.0	0.0	0.0	0.0	0.0	0.0	0.0	0.0		0.0	0.0	
Detector 2 Position(m)		28.7			28.7			28.7			28.7	
Detector 2 Size(m)		1.8			1.8			1.8			1.8	
Detector 2 Type		Cl+Ex			Cl+Ex			Cl+Ex			Cl+Ex	
Detector 2 Channel												
Detector 2 Extend (s)		0.0			0.0			0.0			0.0	
Turn Type	Perm	NA	Perm	pm+pt	NA	Perm	Perm	NA		Perm	NA	
Protected Phases		4		3	8			2			6	
Permitted Phases	4		4	8		8	2			6		
Detector Phase	4	4	4	3	8	8	2	2		6	6	

4: Conroy & St. Laurent
PM Peak Hour

2510 St. Laurent Boulevard
2022 Existing Traffic

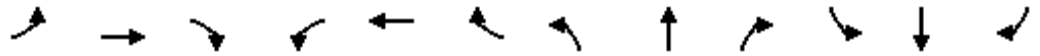

Lane Group	EBL	EBT	EBR	WBL	WBT	WBR	NBL	NBT	NBR	SBL	SBT	SBR
Switch Phase												
Minimum Initial (s)	10.0	10.0	10.0	5.0	10.0	10.0	10.0	10.0		10.0	10.0	
Minimum Split (s)	43.9	43.9	43.9	11.3	43.9	43.9	30.3	30.3		30.3	30.3	
Total Split (s)	44.0	44.0	44.0	15.0	59.0	59.0	36.0	36.0		36.0	36.0	
Total Split (%)	46.3%	46.3%	46.3%	15.8%	62.1%	62.1%	37.9%	37.9%		37.9%	37.9%	
Maximum Green (s)	37.1	37.1	37.1	9.3	52.1	52.1	29.7	29.7		29.7	29.7	
Yellow Time (s)	3.3	3.3	3.3	3.3	3.3	3.3	3.7	3.7		3.7	3.7	
All-Red Time (s)	3.6	3.6	3.6	2.4	3.6	3.6	2.6	2.6		2.6	2.6	
Lost Time Adjust (s)	0.0	0.0	0.0	0.0	0.0	0.0	0.0	0.0		0.0	0.0	
Total Lost Time (s)	6.9	6.9	6.9	5.7	6.9	6.9	6.3	6.3		6.3	6.3	
Lead/Lag	Lag	Lag	Lag	Lead								
Lead-Lag Optimize?	Yes	Yes	Yes	Yes								
Vehicle Extension (s)	3.0	3.0	3.0	3.0	3.0	3.0	3.0	3.0		3.0	3.0	
Recall Mode	None	None	None	None	None	None	C-Max	C-Max		C-Max	C-Max	
Walk Time (s)	7.0	7.0	7.0		7.0	7.0	7.0	7.0		7.0	7.0	
Flash Dont Walk (s)	30.0	30.0	30.0		30.0	30.0	17.0	17.0		17.0	17.0	
Pedestrian Calls (#/hr)	5	5	5		5	5	10	10		10	10	
Act Effct Green (s)	22.3	22.3	22.3	38.5	37.3	37.3	44.5	44.5		44.5	44.5	
Actuated g/C Ratio	0.23	0.23	0.23	0.41	0.39	0.39	0.47	0.47		0.47	0.47	
v/c Ratio	0.06	0.18	0.79	0.54	0.05	0.19	0.38	0.33		0.16	0.77	
Control Delay	23.4	26.4	34.3	22.8	14.4	7.6	37.3	17.5		21.4	27.8	
Queue Delay	0.0	0.0	0.0	0.0	0.0	0.0	0.0	0.0		0.0	0.0	
Total Delay	23.4	26.4	34.3	22.8	14.4	7.6	37.3	17.5		21.4	27.8	
LOS	C	C	C	C	B	A	D	B		C	C	
Approach Delay		32.5			17.6			18.6			27.6	
Approach LOS		C			B			B			C	
Queue Length 50th (m)	2.6	10.2	37.0	29.3	3.3	5.2	4.0	24.9		3.7	82.4	
Queue Length 95th (m)	6.0	16.0	51.8	32.7	5.9	10.8	#20.4	44.7		13.2	#162.8	
Internal Link Dist (m)		173.7			247.8			348.7			324.5	
Turn Bay Length (m)	45.0		50.0	55.0		55.0				110.0		
Base Capacity (vph)	506	674	640	460	887	833	102	2177		262	1550	
Starvation Cap Reductn	0	0	0	0	0	0	0	0		0	0	
Spillback Cap Reductn	0	0	0	0	0	0	0	0		0	0	
Storage Cap Reductn	0	0	0	0	0	0	0	0		0	0	
Reduced v/c Ratio	0.04	0.11	0.53	0.54	0.03	0.14	0.38	0.33		0.16	0.77	

Intersection Summary

Area Type: Other
 Cycle Length: 95
 Actuated Cycle Length: 95
 Offset: 2 (2%), Referenced to phase 2:NBT and 6:SBTL, Start of Green
 Natural Cycle: 90
 Control Type: Actuated-Coordinated
 Maximum v/c Ratio: 0.79
 Intersection Signal Delay: 24.5
 Intersection LOS: C
 Intersection Capacity Utilization 81.8%
 ICU Level of Service D
 Analysis Period (min) 15
 # 95th percentile volume exceeds capacity, queue may be longer.
 Queue shown is maximum after two cycles.

Splits and Phases: 4: Conroy & St. Laurent

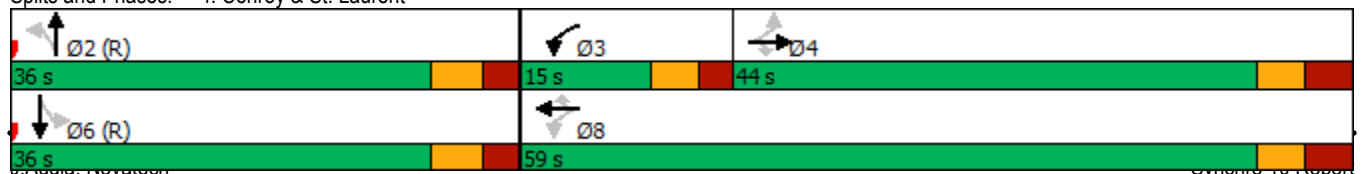



Lane Group	WBL	WBR	NBT	NBR	SBL	SBT
Lane Configurations						
Traffic Volume (vph)	22	56	107	77	151	51
Future Volume (vph)	22	56	107	77	151	51
Ideal Flow (vphpl)	1800	1800	1800	1800	1800	1800
Lane Util. Factor	1.00	1.00	1.00	1.00	1.00	1.00
Ped Bike Factor						
Frt	0.903		0.943			
Flt Protected	0.986					0.964
Satd. Flow (prot)	1479	0	1639	0	0	1588
Flt Permitted	0.986					0.964
Satd. Flow (perm)	1479	0	1639	0	0	1588
Link Speed (k/h)	50		50			50
Link Distance (m)	137.6		234.0			146.3
Travel Time (s)	9.9		16.8			10.5
Confl. Peds. (#/hr)				2	2	
Confl. Bikes (#/hr)		1		4		
Peak Hour Factor	0.90	0.90	0.90	0.90	0.90	0.90
Heavy Vehicles (%)	5%	8%	2%	3%	4%	20%
Adj. Flow (vph)	24	62	119	86	168	57
Shared Lane Traffic (%)						
Lane Group Flow (vph)	86	0	205	0	0	225
Enter Blocked Intersection	No	No	No	No	No	No
Lane Alignment	Left	Right	Left	Right	Left	Left
Median Width(m)	3.5		0.0			0.0
Link Offset(m)	0.0		0.0			0.0
Crosswalk Width(m)	2.0		10.0			10.0
Two way Left Turn Lane						
Headway Factor	1.09	1.09	1.09	1.09	1.09	1.09
Turning Speed (k/h)	24	14		14	24	
Sign Control	Stop		Free			Free

Intersection Summary

Area Type: Other

Control Type: Unsignalized

Intersection Capacity Utilization 37.7%

ICU Level of Service A

Analysis Period (min) 15

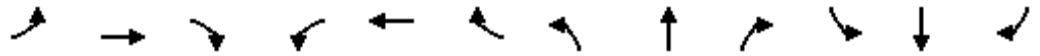

Lane Group	EBL	EBT	EBR	WBL	WBT	WBR	NBL	NBT	NBR	SBL	SBT	SBR
Lane Configurations												
Traffic Volume (vph)	27	1369	95	13	1400	70	137	0	65	87	99	50
Future Volume (vph)	27	1369	95	13	1400	70	137	0	65	87	99	50
Ideal Flow (vphpl)	1800	1800	1800	1800	1800	1800	1800	1800	1800	1800	1800	1800
Storage Length (m)	40.0		0.0	50.0		0.0	35.0		0.0	30.0		0.0
Storage Lanes	1		0	1		0	1		0	1		0
Taper Length (m)	25.0			30.0			25.0			30.0		
Lane Util. Factor	1.00	0.95	0.95	1.00	0.95	0.95	1.00	1.00	1.00	1.00	1.00	1.00
Ped Bike Factor		1.00			1.00		1.00				1.00	
Frt		0.990			0.993			0.850			0.949	
Flt Protected	0.950			0.950			0.950			0.950		
Satd. Flow (prot)	1674	3242	0	1674	3291	0	1674	1483	0	1674	1648	0
Flt Permitted	0.104			0.105			0.562			0.710		
Satd. Flow (perm)	183	3242	0	185	3291	0	989	1483	0	1251	1648	0
Right Turn on Red			Yes			Yes			Yes			Yes
Satd. Flow (RTOR)		12			9			38			23	
Link Speed (k/h)		50			50			50			50	
Link Distance (m)		402.0			171.1			100.3			281.0	
Travel Time (s)		28.9			12.3			7.2			20.2	
Confl. Peds. (#/hr)	1		10	10		1	2					2
Confl. Bikes (#/hr)			1									
Peak Hour Factor	0.90	0.90	0.90	0.90	0.90	0.90	0.90	0.90	0.90	0.90	0.90	0.90
Heavy Vehicles (%)	1%	3%	3%	1%	2%	1%	1%	1%	2%	1%	1%	4%
Adj. Flow (vph)	30	1521	106	14	1556	78	152	0	72	97	110	56
Shared Lane Traffic (%)												
Lane Group Flow (vph)	30	1627	0	14	1634	0	152	72	0	97	166	0
Enter Blocked Intersection	No	No	No	No	No	No	No	No	No	No	No	No
Lane Alignment	L NA	Left	R NA	Left	Left	Right	L NA	Left	R NA	L NA	Left	R NA
Median Width(m)		5.0			5.0			3.5			3.5	
Link Offset(m)		0.0			0.0			0.0			0.0	
Crosswalk Width(m)		5.0			5.0			5.0			5.0	
Two way Left Turn Lane												
Headway Factor	1.09	1.09	1.09	1.09	1.09	1.09	1.09	1.09	1.09	1.09	1.09	1.09
Turning Speed (k/h)	24		14	24		14	24		14	24		14
Number of Detectors	1	2		1	2		1	2		1	2	
Detector Template	Left	Thru		Left	Thru		Left	Thru		Left	Thru	
Leading Detector (m)	6.1	30.5		6.1	30.5		6.1	30.5		6.1	30.5	
Trailing Detector (m)	0.0	0.0		0.0	0.0		0.0	0.0		0.0	0.0	
Detector 1 Position(m)	0.0	0.0		0.0	0.0		0.0	0.0		0.0	0.0	
Detector 1 Size(m)	6.1	1.8		6.1	1.8		6.1	1.8		6.1	1.8	
Detector 1 Type	Cl+Ex	Cl+Ex		Cl+Ex	Cl+Ex		Cl+Ex	Cl+Ex		Cl+Ex	Cl+Ex	
Detector 1 Channel												
Detector 1 Extend (s)	0.0	0.0		0.0	0.0		0.0	0.0		0.0	0.0	
Detector 1 Queue (s)	0.0	0.0		0.0	0.0		0.0	0.0		0.0	0.0	
Detector 1 Delay (s)	0.0	0.0		0.0	0.0		0.0	0.0		0.0	0.0	
Detector 2 Position(m)		28.7			28.7			28.7			28.7	
Detector 2 Size(m)		1.8			1.8			1.8			1.8	
Detector 2 Type		Cl+Ex			Cl+Ex			Cl+Ex			Cl+Ex	
Detector 2 Channel												
Detector 2 Extend (s)		0.0			0.0			0.0			0.0	
Turn Type	Perm	NA		Perm	NA		Perm	NA		Perm	NA	
Protected Phases		2			6			8			4	
Permitted Phases	2			6			8			4		
Detector Phase	2	2		6	6		8	8		4	4	



Lane Group	EBL	EBT	EBR	WBL	WBT	WBR	NBL	NBT	NBR	SBL	SBT	SBR
Switch Phase												
Minimum Initial (s)	10.0	10.0		10.0	10.0		10.0	10.0		10.0	10.0	
Minimum Split (s)	35.9	35.9		35.9	35.9		36.2	36.2		36.2	36.2	
Total Split (s)	74.0	74.0		74.0	74.0		36.0	36.0		36.0	36.0	
Total Split (%)	67.3%	67.3%		67.3%	67.3%		32.7%	32.7%		32.7%	32.7%	
Maximum Green (s)	68.1	68.1		68.1	68.1		29.8	29.8		29.8	29.8	
Yellow Time (s)	3.3	3.3		3.3	3.3		3.3	3.3		3.3	3.3	
All-Red Time (s)	2.6	2.6		2.6	2.6		2.9	2.9		2.9	2.9	
Lost Time Adjust (s)	0.0	0.0		0.0	0.0		0.0	0.0		0.0	0.0	
Total Lost Time (s)	5.9	5.9		5.9	5.9		6.2	6.2		6.2	6.2	
Lead/Lag												
Lead-Lag Optimize?												
Vehicle Extension (s)	3.0	3.0		3.0	3.0		3.0	3.0		3.0	3.0	
Recall Mode	C-Max	C-Max		C-Max	C-Max		None	None		None	None	
Walk Time (s)	15.0	15.0		15.0	15.0		10.0	10.0		10.0	10.0	
Flash Dont Walk (s)	15.0	15.0		15.0	15.0		20.0	20.0		20.0	20.0	
Pedestrian Calls (#/hr)	10	10		5	5		5	5		5	5	
Act Effct Green (s)	77.1	77.1		77.1	77.1		20.8	20.8		20.8	20.8	
Actuated g/C Ratio	0.70	0.70		0.70	0.70		0.19	0.19		0.19	0.19	
v/c Ratio	0.23	0.72		0.11	0.71		0.81	0.23		0.41	0.50	
Control Delay	13.7	13.4		7.8	8.5		72.5	20.2		42.5	38.1	
Queue Delay	0.0	0.0		0.0	0.0		0.0	0.0		0.0	0.0	
Total Delay	13.7	13.4		7.8	8.5		72.5	20.2		42.5	38.1	
LOS	B	B		A	A		E	C		D	D	
Approach Delay		13.4			8.5			55.7			39.7	
Approach LOS		B			A			E			D	
Queue Length 50th (m)	1.9	89.5		0.6	45.3		29.0	5.6		17.0	25.4	
Queue Length 95th (m)	8.7	148.7		m1.2	50.2		46.0	15.3		28.6	39.9	
Internal Link Dist (m)		378.0			147.1			76.3			257.0	
Turn Bay Length (m)	40.0			50.0			35.0			30.0		
Base Capacity (vph)	128	2275		129	2308		267	429		338	463	
Starvation Cap Reductn	0	0		0	0		0	0		0	0	
Spillback Cap Reductn	0	0		0	0		0	0		0	0	
Storage Cap Reductn	0	0		0	0		0	0		0	0	
Reduced v/c Ratio	0.23	0.72		0.11	0.71		0.57	0.17		0.29	0.36	

Intersection Summary

Area Type: Other
 Cycle Length: 110
 Actuated Cycle Length: 110
 Offset: 20 (18%), Referenced to phase 2:EBTL and 6:WBTL, Start of Green
 Natural Cycle: 90
 Control Type: Actuated-Coordinated
 Maximum v/c Ratio: 0.81
 Intersection Signal Delay: 15.6
 Intersection LOS: B
 Intersection Capacity Utilization 76.6%
 ICU Level of Service D
 Analysis Period (min) 15
 m Volume for 95th percentile queue is metered by upstream signal.

Splits and Phases: 1: Don Reid/Ryder & Walkley

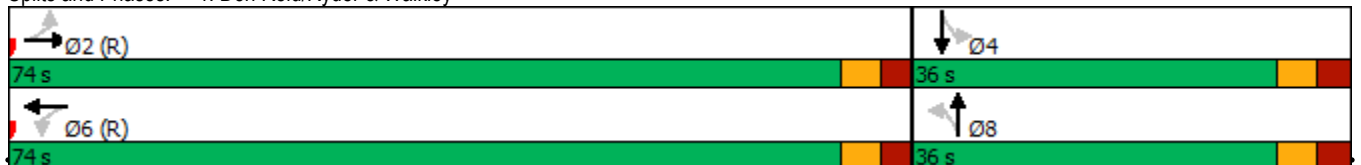

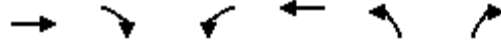

Lane Group	EBT	EBR	WBL	WBT	NBL	NBR
Lane Configurations	↑↑	↑	↓	↑↑	↓	↑
Traffic Volume (vph)	1532	64	36	1418	49	41
Future Volume (vph)	1532	64	36	1418	49	41
Ideal Flow (vphpl)	1800	1800	1800	1800	1800	1800
Storage Length (m)		20.0	65.0		30.0	0.0
Storage Lanes		1	1		1	1
Taper Length (m)			25.0		30.0	
Lane Util. Factor	0.95	1.00	1.00	0.95	1.00	1.00
Ped Bike Factor		0.97	1.00			0.99
Fr _t		0.850				0.850
Fl _t Protected			0.950		0.950	
Satd. Flow (prot)	3252	1483	1642	3316	1658	1483
Fl _t Permitted			0.116		0.950	
Satd. Flow (perm)	3252	1441	200	3316	1658	1463
Right Turn on Red		Yes				Yes
Satd. Flow (RTOR)		31				37
Link Speed (k/h)	50			50	50	
Link Distance (m)	171.1			169.1	128.6	
Travel Time (s)	12.3			12.2	9.3	
Confl. Peds. (#/hr)		5	5			1
Peak Hour Factor	0.90	0.90	0.90	0.90	0.90	0.90
Heavy Vehicles (%)	4%	2%	3%	2%	2%	2%
Adj. Flow (vph)	1702	71	40	1576	54	46
Shared Lane Traffic (%)						
Lane Group Flow (vph)	1702	71	40	1576	54	46
Enter Blocked Intersection	No	No	No	No	No	No
Lane Alignment	Left	Right	L NA	Left	L NA	R NA
Median Width(m)	3.5			5.0	3.5	
Link Offset(m)	0.0			0.0	0.0	
Crosswalk Width(m)	5.0			5.0	5.0	
Two way Left Turn Lane						
Headway Factor	1.09	1.09	1.09	1.09	1.09	1.09
Turning Speed (k/h)		14	24		24	14
Number of Detectors	2	1	1	2	1	1
Detector Template	Thru	Right	Left	Thru	Left	Right
Leading Detector (m)	30.5	6.1	6.1	30.5	6.1	6.1
Trailing Detector (m)	0.0	0.0	0.0	0.0	0.0	0.0
Detector 1 Position(m)	0.0	0.0	0.0	0.0	0.0	0.0
Detector 1 Size(m)	1.8	6.1	6.1	1.8	6.1	6.1
Detector 1 Type	CI+Ex	CI+Ex	CI+Ex	CI+Ex	CI+Ex	CI+Ex
Detector 1 Channel						
Detector 1 Extend (s)	0.0	0.0	0.0	0.0	0.0	0.0
Detector 1 Queue (s)	0.0	0.0	0.0	0.0	0.0	0.0
Detector 1 Delay (s)	0.0	0.0	0.0	0.0	0.0	0.0
Detector 2 Position(m)	28.7			28.7		
Detector 2 Size(m)	1.8			1.8		
Detector 2 Type	CI+Ex			CI+Ex		
Detector 2 Channel						
Detector 2 Extend (s)	0.0			0.0		
Turn Type	NA	Perm	Perm	NA	Prot	Perm
Protected Phases	2			6	8	
Permitted Phases		2	6			8
Detector Phase	2	2	6	6	8	8
Switch Phase						

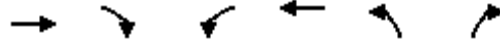

Lane Group	EBT	EBR	WBL	WBT	NBL	NBR
Minimum Initial (s)	10.0	10.0	10.0	10.0	5.0	5.0
Minimum Split (s)	37.0	37.0	37.0	37.0	29.0	29.0
Total Split (s)	81.0	81.0	81.0	81.0	29.0	29.0
Total Split (%)	73.6%	73.6%	73.6%	73.6%	26.4%	26.4%
Maximum Green (s)	75.0	75.0	75.0	75.0	23.0	23.0
Yellow Time (s)	3.3	3.3	3.3	3.3	3.3	3.3
All-Red Time (s)	2.7	2.7	2.7	2.7	2.7	2.7
Lost Time Adjust (s)	0.0	0.0	0.0	0.0	0.0	0.0
Total Lost Time (s)	6.0	6.0	6.0	6.0	6.0	6.0
Lead/Lag						
Lead-Lag Optimize?						
Vehicle Extension (s)	3.0	3.0	3.0	3.0	3.0	3.0
Recall Mode	C-Max	C-Max	C-Max	C-Max	None	None
Walk Time (s)	18.0	18.0			7.0	7.0
Flash Dont Walk (s)	13.0	13.0			16.0	16.0
Pedestrian Calls (#/hr)	5	5			5	5
Act Effct Green (s)	90.4	90.4	90.4	90.4	11.1	11.1
Actuated g/C Ratio	0.82	0.82	0.82	0.82	0.10	0.10
v/c Ratio	0.64	0.06	0.24	0.58	0.33	0.26
Control Delay	2.2	0.8	9.2	6.3	48.5	19.9
Queue Delay	0.0	0.0	0.0	0.5	0.0	0.0
Total Delay	2.3	0.8	9.2	6.7	48.5	19.9
LOS	A	A	A	A	D	B
Approach Delay	2.2			6.8	35.3	
Approach LOS	A			A	D	
Queue Length 50th (m)	16.4	0.3	1.5	46.2	10.3	1.7
Queue Length 95th (m)	22.8	m0.8	9.3	110.7	18.8	10.2
Internal Link Dist (m)	147.1			145.1	104.6	
Turn Bay Length (m)		20.0	65.0		30.0	
Base Capacity (vph)	2673	1190	164	2725	346	335
Starvation Cap Reductn	85	0	0	619	0	0
Spillback Cap Reductn	0	0	0	0	0	0
Storage Cap Reductn	0	0	0	0	0	0
Reduced v/c Ratio	0.66	0.06	0.24	0.75	0.16	0.14

Intersection Summary







Area Type: Other
 Cycle Length: 110
 Actuated Cycle Length: 110
 Offset: 25 (23%), Referenced to phase 2:EBT and 6:WBTL, Start of Green
 Natural Cycle: 80
 Control Type: Actuated-Coordinated
 Maximum v/c Ratio: 0.64
 Intersection Signal Delay: 5.3
 Intersection LOS: A
 Intersection Capacity Utilization 59.4%
 ICU Level of Service B
 Analysis Period (min) 15
 m Volume for 95th percentile queue is metered by upstream signal.

Splits and Phases: 2: 160m W of Conroy & Walkley



























3: Conroy & Walkley
PM Peak Hour

2510 St. Laurent Boulevard
2022 Existing Traffic (mitigated timing)

							
Lane Group	EBT	EBR	WBL	WBT	NBU	NBL	NBR
Lane Configurations	↑↑	↑	↑↑	↑↑		↑↑	↑
Traffic Volume (vph)	1139	438	522	965	42	457	297
Future Volume (vph)	1139	438	522	965	42	457	297
Ideal Flow (vphpl)	1800	1800	1800	1800	1800	1800	1800
Storage Length (m)		75.0	200.0			0.0	0.0
Storage Lanes		1	2			2	1
Taper Length (m)			50.0			10.0	
Lane Util. Factor	0.95	1.00	0.97	0.95	0.95	0.97	1.00
Ped Bike Factor		0.96	0.99				0.96
Fr _t		0.850					0.850
Fl _t Protected			0.950			0.950	
Satd. Flow (prot)	3221	1483	3185	3349	0	3248	1469
Fl _t Permitted			0.950			0.950	
Satd. Flow (perm)	3221	1426	3161	3349	0	3248	1415
Right Turn on Red		Yes					Yes
Satd. Flow (RTOR)		418					330
Link Speed (k/h)	50			50		60	
Link Distance (m)	169.1			271.7		348.5	
Travel Time (s)	12.2			19.6		20.9	
Confl. Peds. (#/hr)		22	22				16
Confl. Bikes (#/hr)		1					1
Peak Hour Factor	0.90	0.90	0.90	0.90	0.90	0.90	0.90
Heavy Vehicles (%)	5%	2%	3%	1%	1%	1%	3%
Adj. Flow (vph)	1266	487	580	1072	47	508	330
Shared Lane Traffic (%)							
Lane Group Flow (vph)	1266	487	580	1072	0	555	330
Enter Blocked Intersection	No	No	No	No	No	No	No
Lane Alignment	Left	R NA	Left	Left	R NA	L NA	R NA
Median Width(m)	7.0			9.0		10.5	
Link Offset(m)	0.0			0.0		0.0	
Crosswalk Width(m)	5.0			5.0		5.0	
Two way Left Turn Lane							
Headway Factor	1.09	1.09	1.09	1.09	1.09	1.09	1.09
Turning Speed (k/h)		14	24		14	24	14
Number of Detectors	2	1	1	2	1	1	1
Detector Template	Thru	Right	Left	Thru	Left	Left	Right
Leading Detector (m)	30.5	6.1	6.1	30.5	6.1	6.1	6.1
Trailing Detector (m)	0.0	0.0	0.0	0.0	0.0	0.0	0.0
Detector 1 Position(m)	0.0	0.0	0.0	0.0	0.0	0.0	0.0
Detector 1 Size(m)	1.8	6.1	6.1	1.8	6.1	6.1	6.1
Detector 1 Type	Cl+Ex	Cl+Ex	Cl+Ex	Cl+Ex	Cl+Ex	Cl+Ex	Cl+Ex
Detector 1 Channel							
Detector 1 Extend (s)	0.0	0.0	0.0	0.0	0.0	0.0	0.0
Detector 1 Queue (s)	0.0	0.0	0.0	0.0	0.0	0.0	0.0
Detector 1 Delay (s)	0.0	0.0	0.0	0.0	0.0	0.0	0.0
Detector 2 Position(m)	28.7			28.7			
Detector 2 Size(m)	1.8			1.8			
Detector 2 Type	Cl+Ex			Cl+Ex			
Detector 2 Channel							
Detector 2 Extend (s)	0.0			0.0			
Turn Type	NA	Perm	Prot	NA	Perm	Prot	Perm
Protected Phases	2		1	6		8	
Permitted Phases		2			8		8
Detector Phase	2	2	1	6	8	8	8

4: Conroy & St. Laurent
PM Peak Hour

2510 St. Laurent Boulevard
2022 Existing Traffic (mitigated timing)

												
Lane Group	EBL	EBT	EBR	WBL	WBT	WBR	NBL	NBT	NBR	SBL	SBT	SBR
Lane Configurations												
Traffic Volume (vph)	17	67	306	222	28	105	35	564	79	37	1064	8
Future Volume (vph)	17	67	306	222	28	105	35	564	79	37	1064	8
Ideal Flow (vphpl)	1800	1800	1800	1800	1800	1800	1800	1800	1800	1800	1800	1800
Storage Length (m)	45.0		50.0	55.0		55.0	0.0		0.0	110.0		0.0
Storage Lanes	1		1	1		1	1		0	1		0
Taper Length (m)	40.0			40.0			10.0			25.0		
Lane Util. Factor	1.00	1.00	1.00	1.00	1.00	1.00	1.00	0.91	0.91	1.00	0.95	0.95
Ped Bike Factor	1.00		0.98	1.00		0.99		0.99		0.99	1.00	
Fr _t			0.850			0.850		0.982			0.999	
Fl _t Protected	0.950			0.950			0.950			0.950		
Satd. Flow (prot)	1674	1728	1483	1642	1618	1483	1642	4617	0	1537	3309	0
Fl _t Permitted	0.737			0.565			0.127			0.349		
Satd. Flow (perm)	1297	1728	1461	974	1618	1463	219	4617	0	560	3309	0
Right Turn on Red			Yes			Yes			Yes			Yes
Satd. Flow (RTOR)			115			68		28			1	
Link Speed (k/h)		50			50			60			60	
Link Distance (m)		197.7			271.8			372.7			348.5	
Travel Time (s)		14.2			19.6			22.4			20.9	
Confl. Peds. (#/hr)	2		4	4		2	8		12	12		8
Confl. Bikes (#/hr)									4			11
Peak Hour Factor	0.90	0.90	0.90	0.90	0.90	0.90	0.90	0.90	0.90	0.90	0.90	0.90
Heavy Vehicles (%)	1%	3%	2%	3%	10%	2%	3%	2%	8%	10%	2%	12%
Adj. Flow (vph)	19	74	340	247	31	117	39	627	88	41	1182	9
Shared Lane Traffic (%)												
Lane Group Flow (vph)	19	74	340	247	31	117	39	715	0	41	1191	0
Enter Blocked Intersection	No	No	No	No	No	No	No	No	No	No	No	No
Lane Alignment	L NA	Left	R NA	L NA	Left	R NA	Left	Left	Right	L NA	Left	R NA
Median Width(m)		3.5			3.5			7.0			6.0	
Link Offset(m)		0.0			0.0			0.0			0.0	
Crosswalk Width(m)		5.0			5.0			5.0			5.0	
Two way Left Turn Lane												
Headway Factor	1.09	1.09	1.09	1.09	1.09	1.09	1.09	1.09	1.09	1.09	1.09	1.09
Turning Speed (k/h)	24		14	24		14	24		14	24		14
Number of Detectors	1	2	1	1	2	1	1	2		1	2	
Detector Template	Left	Thru	Right	Left	Thru	Right	Left	Thru		Left	Thru	
Leading Detector (m)	6.1	30.5	6.1	6.1	30.5	6.1	6.1	30.5		6.1	30.5	
Trailing Detector (m)	0.0	0.0	0.0	0.0	0.0	0.0	0.0	0.0		0.0	0.0	
Detector 1 Position(m)	0.0	0.0	0.0	0.0	0.0	0.0	0.0	0.0		0.0	0.0	
Detector 1 Size(m)	6.1	1.8	6.1	6.1	1.8	6.1	6.1	1.8		6.1	1.8	
Detector 1 Type	Cl+Ex	Cl+Ex	Cl+Ex	Cl+Ex	Cl+Ex	Cl+Ex	Cl+Ex	Cl+Ex		Cl+Ex	Cl+Ex	
Detector 1 Channel												
Detector 1 Extend (s)	0.0	0.0	0.0	0.0	0.0	0.0	0.0	0.0		0.0	0.0	
Detector 1 Queue (s)	0.0	0.0	0.0	0.0	0.0	0.0	0.0	0.0		0.0	0.0	
Detector 1 Delay (s)	0.0	0.0	0.0	0.0	0.0	0.0	0.0	0.0		0.0	0.0	
Detector 2 Position(m)		28.7			28.7			28.7			28.7	
Detector 2 Size(m)		1.8			1.8			1.8			1.8	
Detector 2 Type		Cl+Ex			Cl+Ex			Cl+Ex			Cl+Ex	
Detector 2 Channel												
Detector 2 Extend (s)		0.0			0.0			0.0			0.0	
Turn Type	Perm	NA	Perm	pm+pt	NA	Perm	Perm	NA		Perm	NA	
Protected Phases		4		3	8			2			6	
Permitted Phases	4		4	8		8	2			6		
Detector Phase	4	4	4	3	8	8	2	2		6	6	

4: Conroy & St. Laurent
PM Peak Hour

2510 St. Laurent Boulevard
2022 Existing Traffic (mitigated timing)

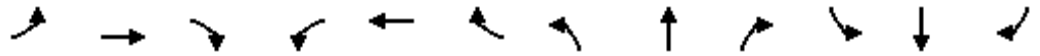

Lane Group	EBL	EBT	EBR	WBL	WBT	WBR	NBL	NBT	NBR	SBL	SBT	SBR
Switch Phase												
Minimum Initial (s)	10.0	10.0	10.0	5.0	10.0	10.0	10.0	10.0		10.0	10.0	
Minimum Split (s)	43.9	43.9	43.9	11.3	43.9	43.9	30.3	30.3		30.3	30.3	
Total Split (s)	44.0	44.0	44.0	15.0	59.0	59.0	36.0	36.0		36.0	36.0	
Total Split (%)	46.3%	46.3%	46.3%	15.8%	62.1%	62.1%	37.9%	37.9%		37.9%	37.9%	
Maximum Green (s)	37.1	37.1	37.1	9.3	52.1	52.1	29.7	29.7		29.7	29.7	
Yellow Time (s)	3.3	3.3	3.3	3.3	3.3	3.3	3.7	3.7		3.7	3.7	
All-Red Time (s)	3.6	3.6	3.6	2.4	3.6	3.6	2.6	2.6		2.6	2.6	
Lost Time Adjust (s)	0.0	0.0	0.0	0.0	0.0	0.0	0.0	0.0		0.0	0.0	
Total Lost Time (s)	6.9	6.9	6.9	5.7	6.9	6.9	6.3	6.3		6.3	6.3	
Lead/Lag	Lag	Lag	Lag	Lead								
Lead-Lag Optimize?	Yes	Yes	Yes	Yes								
Vehicle Extension (s)	3.0	3.0	3.0	3.0	3.0	3.0	3.0	3.0		3.0	3.0	
Recall Mode	None	None	None	None	None	None	C-Max	C-Max		C-Max	C-Max	
Walk Time (s)	7.0	7.0	7.0		7.0	7.0	7.0	7.0		7.0	7.0	
Flash Dont Walk (s)	30.0	30.0	30.0		30.0	30.0	17.0	17.0		17.0	17.0	
Pedestrian Calls (#/hr)	5	5	5		5	5	10	10		10	10	
Act Effct Green (s)	22.3	22.3	22.3	38.5	37.3	37.3	44.5	44.5		44.5	44.5	
Actuated g/C Ratio	0.23	0.23	0.23	0.41	0.39	0.39	0.47	0.47		0.47	0.47	
v/c Ratio	0.06	0.18	0.79	0.54	0.05	0.19	0.38	0.33		0.16	0.77	
Control Delay	23.4	26.4	34.3	22.8	14.4	7.6	37.3	17.5		21.4	27.8	
Queue Delay	0.0	0.0	0.0	0.0	0.0	0.0	0.0	0.0		0.0	0.0	
Total Delay	23.4	26.4	34.3	22.8	14.4	7.6	37.3	17.5		21.4	27.8	
LOS	C	C	C	C	B	A	D	B		C	C	
Approach Delay		32.5			17.6			18.6			27.6	
Approach LOS		C			B			B			C	
Queue Length 50th (m)	2.6	10.2	37.0	29.3	3.3	5.2	4.0	24.9		3.7	82.4	
Queue Length 95th (m)	6.0	16.0	51.8	32.7	5.9	10.8	#20.4	44.7		13.2	#162.8	
Internal Link Dist (m)		173.7			247.8			348.7			324.5	
Turn Bay Length (m)	45.0		50.0	55.0		55.0				110.0		
Base Capacity (vph)	506	674	640	460	887	833	102	2177		262	1550	
Starvation Cap Reductn	0	0	0	0	0	0	0	0		0	0	
Spillback Cap Reductn	0	0	0	0	0	0	0	0		0	0	
Storage Cap Reductn	0	0	0	0	0	0	0	0		0	0	
Reduced v/c Ratio	0.04	0.11	0.53	0.54	0.03	0.14	0.38	0.33		0.16	0.77	

Intersection Summary

Area Type: Other
 Cycle Length: 95
 Actuated Cycle Length: 95
 Offset: 2 (2%), Referenced to phase 2:NBT and 6:SBTL, Start of Green
 Natural Cycle: 90
 Control Type: Actuated-Coordinated
 Maximum v/c Ratio: 0.79
 Intersection Signal Delay: 24.5
 Intersection LOS: C
 Intersection Capacity Utilization 81.8%
 ICU Level of Service D
 Analysis Period (min) 15
 # 95th percentile volume exceeds capacity, queue may be longer.
 Queue shown is maximum after two cycles.

Splits and Phases: 4: Conroy & St. Laurent

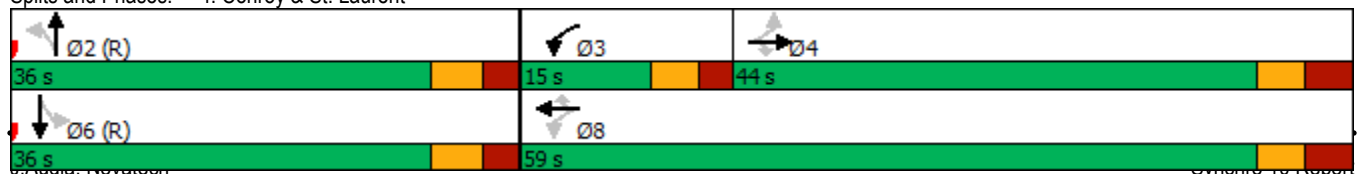



Lane Group	WBL	WBR	NBT	NBR	SBL	SBT
Lane Configurations						
Traffic Volume (vph)	22	56	107	77	151	51
Future Volume (vph)	22	56	107	77	151	51
Ideal Flow (vphpl)	1800	1800	1800	1800	1800	1800
Lane Util. Factor	1.00	1.00	1.00	1.00	1.00	1.00
Ped Bike Factor						
Frt	0.903		0.943			
Flt Protected	0.986					0.964
Satd. Flow (prot)	1479	0	1639	0	0	1588
Flt Permitted	0.986					0.964
Satd. Flow (perm)	1479	0	1639	0	0	1588
Link Speed (k/h)	50		50			50
Link Distance (m)	137.6		234.0			146.3
Travel Time (s)	9.9		16.8			10.5
Confl. Peds. (#/hr)				2	2	
Confl. Bikes (#/hr)		1		4		
Peak Hour Factor	0.90	0.90	0.90	0.90	0.90	0.90
Heavy Vehicles (%)	5%	8%	2%	3%	4%	20%
Adj. Flow (vph)	24	62	119	86	168	57
Shared Lane Traffic (%)						
Lane Group Flow (vph)	86	0	205	0	0	225
Enter Blocked Intersection	No	No	No	No	No	No
Lane Alignment	Left	Right	Left	Right	Left	Left
Median Width(m)	3.5		0.0			0.0
Link Offset(m)	0.0		0.0			0.0
Crosswalk Width(m)	2.0		10.0			10.0
Two way Left Turn Lane						
Headway Factor	1.09	1.09	1.09	1.09	1.09	1.09
Turning Speed (k/h)	24	14		14	24	
Sign Control	Stop		Free			Free

Intersection Summary

Area Type: Other

Control Type: Unsignalized

Intersection Capacity Utilization 37.7%

ICU Level of Service A

Analysis Period (min) 15

APPENDIX K

Background Synchro Analysis

Lane Group	EBL	EBT	EBR	WBL	WBT	WBR	NBL	NBT	NBR	SBL	SBT	SBR
Lane Configurations												
Traffic Volume (vph)	29	925	164	41	1410	195	78	7	53	49	47	39
Future Volume (vph)	29	925	164	41	1410	195	78	7	53	49	47	39
Ideal Flow (vphpl)	1800	1800	1800	1800	1800	1800	1800	1800	1800	1800	1800	1800
Storage Length (m)	40.0		0.0	50.0		0.0	35.0		0.0	30.0		0.0
Storage Lanes	1		0	1		0	1		0	1		0
Taper Length (m)	25.0			30.0			25.0			30.0		
Lane Util. Factor	1.00	0.95	0.95	1.00	0.95	0.95	1.00	1.00	1.00	1.00	1.00	1.00
Ped Bike Factor		1.00		1.00	1.00		1.00	0.99			0.99	
Frt		0.977			0.982			0.867			0.932	
Flt Protected	0.950			0.950			0.950			0.950		
Satd. Flow (prot)	1537	3177	0	1642	3169	0	1580	1378	0	1674	1633	0
Flt Permitted	0.121			0.241			0.701			0.718		
Satd. Flow (perm)	196	3177	0	416	3169	0	1165	1378	0	1265	1633	0
Right Turn on Red			Yes			Yes			Yes			Yes
Satd. Flow (RTOR)		34			26			53			39	
Link Speed (k/h)		50			50			50			50	
Link Distance (m)		402.0			171.1			100.3			281.0	
Travel Time (s)		28.9			12.3			7.2			20.2	
Confl. Peds. (#/hr)	1		5	5		1	1					1
Confl. Bikes (#/hr)									1			
Peak Hour Factor	1.00	1.00	1.00	1.00	1.00	1.00	1.00	1.00	1.00	1.00	1.00	1.00
Heavy Vehicles (%)	10%	4%	1%	3%	5%	1%	7%	1%	12%	1%	1%	1%
Adj. Flow (vph)	29	925	164	41	1410	195	78	7	53	49	47	39
Shared Lane Traffic (%)												
Lane Group Flow (vph)	29	1089	0	41	1605	0	78	60	0	49	86	0
Enter Blocked Intersection	No	No	No	No	No	No	No	No	No	No	No	No
Lane Alignment	L NA	Left	R NA	Left	Left	Right	L NA	Left	R NA	L NA	Left	R NA
Median Width(m)		5.0			5.0			3.5			3.5	
Link Offset(m)		0.0			0.0			0.0			0.0	
Crosswalk Width(m)		5.0			5.0			5.0			5.0	
Two way Left Turn Lane												
Headway Factor	1.09	1.09	1.09	1.09	1.09	1.09	1.09	1.09	1.09	1.09	1.09	1.09
Turning Speed (k/h)	24		14	24		14	24		14	24		14
Number of Detectors	1	2		1	2		1	2		1	2	
Detector Template	Left	Thru		Left	Thru		Left	Thru		Left	Thru	
Leading Detector (m)	6.1	30.5		6.1	30.5		6.1	30.5		6.1	30.5	
Trailing Detector (m)	0.0	0.0		0.0	0.0		0.0	0.0		0.0	0.0	
Detector 1 Position(m)	0.0	0.0		0.0	0.0		0.0	0.0		0.0	0.0	
Detector 1 Size(m)	6.1	1.8		6.1	1.8		6.1	1.8		6.1	1.8	
Detector 1 Type	Cl+Ex	Cl+Ex		Cl+Ex	Cl+Ex		Cl+Ex	Cl+Ex		Cl+Ex	Cl+Ex	
Detector 1 Channel												
Detector 1 Extend (s)	0.0	0.0		0.0	0.0		0.0	0.0		0.0	0.0	
Detector 1 Queue (s)	0.0	0.0		0.0	0.0		0.0	0.0		0.0	0.0	
Detector 1 Delay (s)	0.0	0.0		0.0	0.0		0.0	0.0		0.0	0.0	
Detector 2 Position(m)		28.7			28.7			28.7			28.7	
Detector 2 Size(m)		1.8			1.8			1.8			1.8	
Detector 2 Type		Cl+Ex			Cl+Ex			Cl+Ex			Cl+Ex	
Detector 2 Channel												
Detector 2 Extend (s)		0.0			0.0			0.0			0.0	
Turn Type	Perm	NA		Perm	NA		Perm	NA		Perm	NA	
Protected Phases		2			6			8			4	
Permitted Phases	2			6			8			4		
Detector Phase	2	2		6	6		8	8		4	4	

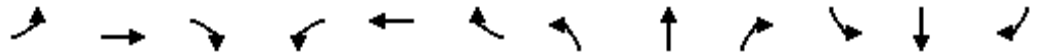

Lane Group	EBL	EBT	EBR	WBL	WBT	WBR	NBL	NBT	NBR	SBL	SBT	SBR
Switch Phase												
Minimum Initial (s)	10.0	10.0		10.0	10.0		10.0	10.0		10.0	10.0	
Minimum Split (s)	35.9	35.9		35.9	35.9		36.2	36.2		36.2	36.2	
Total Split (s)	64.0	64.0		64.0	64.0		36.0	36.0		36.0	36.0	
Total Split (%)	64.0%	64.0%		64.0%	64.0%		36.0%	36.0%		36.0%	36.0%	
Maximum Green (s)	58.1	58.1		58.1	58.1		29.8	29.8		29.8	29.8	
Yellow Time (s)	3.3	3.3		3.3	3.3		3.3	3.3		3.3	3.3	
All-Red Time (s)	2.6	2.6		2.6	2.6		2.9	2.9		2.9	2.9	
Lost Time Adjust (s)	0.0	0.0		0.0	0.0		0.0	0.0		0.0	0.0	
Total Lost Time (s)	5.9	5.9		5.9	5.9		6.2	6.2		6.2	6.2	
Lead/Lag												
Lead-Lag Optimize?												
Vehicle Extension (s)	3.0	3.0		3.0	3.0		3.0	3.0		3.0	3.0	
Recall Mode	C-Max	C-Max		C-Max	C-Max		None	None		None	None	
Walk Time (s)	15.0	15.0		15.0	15.0		10.0	10.0		10.0	10.0	
Flash Dont Walk (s)	15.0	15.0		15.0	15.0		20.0	20.0		20.0	20.0	
Pedestrian Calls (#/hr)	5	5		5	5		5	5		5	5	
Act Effct Green (s)	77.1	77.1		77.1	77.1		15.2	15.2		15.2	15.2	
Actuated g/C Ratio	0.77	0.77		0.77	0.77		0.15	0.15		0.15	0.15	
v/c Ratio	0.19	0.44		0.13	0.66		0.44	0.24		0.26	0.30	
Control Delay	11.1	6.8		4.5	5.0		44.0	12.8		37.6	23.0	
Queue Delay	0.0	0.0		0.0	0.0		0.0	0.0		0.0	0.0	
Total Delay	11.1	6.8		4.5	5.1		44.0	12.8		37.6	23.0	
LOS	B	A		A	A		D	B		D	C	
Approach Delay		6.9			5.0			30.4			28.3	
Approach LOS		A			A			C			C	
Queue Length 50th (m)	1.2	29.4		1.0	26.6		13.3	1.1		8.1	7.7	
Queue Length 95th (m)	8.3	75.7		22.2	29.6		21.3	9.1		14.5	16.3	
Internal Link Dist (m)		378.0			147.1			76.3			257.0	
Turn Bay Length (m)	40.0			50.0			35.0			30.0		
Base Capacity (vph)	151	2456		320	2448		347	447		376	514	
Starvation Cap Reductn	0	0		0	18		0	0		0	0	
Spillback Cap Reductn	0	0		0	0		0	0		0	0	
Storage Cap Reductn	0	0		0	0		0	0		0	0	
Reduced v/c Ratio	0.19	0.44		0.13	0.66		0.22	0.13		0.13	0.17	

Intersection Summary

Area Type: Other
 Cycle Length: 100
 Actuated Cycle Length: 100
 Offset: 94 (94%), Referenced to phase 2:EBTL and 6:WBTL, Start of Green
 Natural Cycle: 90
 Control Type: Actuated-Coordinated
 Maximum v/c Ratio: 0.66
 Intersection Signal Delay: 7.9
 Intersection LOS: A
 Intersection Capacity Utilization 69.0%
 ICU Level of Service C
 Analysis Period (min) 15
 m Volume for 95th percentile queue is metered by upstream signal.

Splits and Phases: 1: Don Reid/Ryder & Walkley

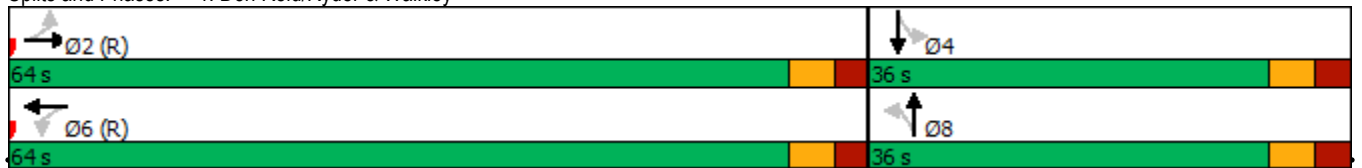

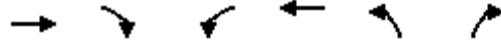

Lane Group	EBT	EBR	WBL	WBT	NBL	NBR
Lane Configurations	↑↑	↑	↑	↑↑	↑	↑
Traffic Volume (vph)	947	90	74	1590	66	60
Future Volume (vph)	947	90	74	1590	66	60
Ideal Flow (vphpl)	1800	1800	1800	1800	1800	1800
Storage Length (m)		20.0	65.0		30.0	0.0
Storage Lanes		1	1		1	1
Taper Length (m)			25.0		30.0	
Lane Util. Factor	0.95	1.00	1.00	0.95	1.00	1.00
Ped Bike Factor		0.97	1.00			0.99
Frt		0.850				0.850
Flt Protected			0.950		0.950	
Satd. Flow (prot)	3221	1498	1674	3191	1674	1483
Flt Permitted			0.292		0.950	
Satd. Flow (perm)	3221	1459	514	3191	1674	1462
Right Turn on Red		Yes				Yes
Satd. Flow (RTOR)		72				60
Link Speed (k/h)	50			50	50	
Link Distance (m)	171.1			169.1	128.6	
Travel Time (s)	12.3			12.2	9.3	
Confl. Peds. (#/hr)		4	4			2
Peak Hour Factor	1.00	1.00	1.00	1.00	1.00	1.00
Heavy Vehicles (%)	5%	1%	1%	6%	1%	2%
Adj. Flow (vph)	947	90	74	1590	66	60
Shared Lane Traffic (%)						
Lane Group Flow (vph)	947	90	74	1590	66	60
Enter Blocked Intersection	No	No	No	No	No	No
Lane Alignment	Left	Right	L NA	Left	L NA	R NA
Median Width(m)	3.5			5.0	3.5	
Link Offset(m)	0.0			0.0	0.0	
Crosswalk Width(m)	5.0			5.0	5.0	
Two way Left Turn Lane						
Headway Factor	1.09	1.09	1.09	1.09	1.09	1.09
Turning Speed (k/h)		14	24		24	14
Number of Detectors	2	1	1	2	1	1
Detector Template	Thru	Right	Left	Thru	Left	Right
Leading Detector (m)	30.5	6.1	6.1	30.5	6.1	6.1
Trailing Detector (m)	0.0	0.0	0.0	0.0	0.0	0.0
Detector 1 Position(m)	0.0	0.0	0.0	0.0	0.0	0.0
Detector 1 Size(m)	1.8	6.1	6.1	1.8	6.1	6.1
Detector 1 Type	CI+Ex	CI+Ex	CI+Ex	CI+Ex	CI+Ex	CI+Ex
Detector 1 Channel						
Detector 1 Extend (s)	0.0	0.0	0.0	0.0	0.0	0.0
Detector 1 Queue (s)	0.0	0.0	0.0	0.0	0.0	0.0
Detector 1 Delay (s)	0.0	0.0	0.0	0.0	0.0	0.0
Detector 2 Position(m)	28.7			28.7		
Detector 2 Size(m)	1.8			1.8		
Detector 2 Type	CI+Ex			CI+Ex		
Detector 2 Channel						
Detector 2 Extend (s)	0.0			0.0		
Turn Type	NA	Perm	Perm	NA	Prot	Perm
Protected Phases	2			6	8	
Permitted Phases		2	6			8
Detector Phase	2	2	6	6	8	8
Switch Phase						



Lane Group	EBT	EBR	WBL	WBT	NBL	NBR
Minimum Initial (s)	10.0	10.0	10.0	10.0	5.0	5.0
Minimum Split (s)	37.0	37.0	37.0	37.0	29.0	29.0
Total Split (s)	71.0	71.0	71.0	71.0	29.0	29.0
Total Split (%)	71.0%	71.0%	71.0%	71.0%	29.0%	29.0%
Maximum Green (s)	65.0	65.0	65.0	65.0	23.0	23.0
Yellow Time (s)	3.3	3.3	3.3	3.3	3.3	3.3
All-Red Time (s)	2.7	2.7	2.7	2.7	2.7	2.7
Lost Time Adjust (s)	0.0	0.0	0.0	0.0	0.0	0.0
Total Lost Time (s)	6.0	6.0	6.0	6.0	6.0	6.0
Lead/Lag						
Lead-Lag Optimize?						
Vehicle Extension (s)	3.0	3.0	3.0	3.0	3.0	3.0
Recall Mode	C-Max	C-Max	C-Max	C-Max	None	None
Walk Time (s)	18.0	18.0			7.0	7.0
Flash Dont Walk (s)	13.0	13.0			16.0	16.0
Pedestrian Calls (#/hr)	5	5			5	5
Act Effct Green (s)	80.2	80.2	80.2	80.2	11.3	11.3
Actuated g/C Ratio	0.80	0.80	0.80	0.80	0.11	0.11
v/c Ratio	0.37	0.08	0.18	0.62	0.35	0.28
Control Delay	3.0	0.8	5.8	7.5	43.6	12.5
Queue Delay	0.0	0.0	0.0	0.4	0.0	0.0
Total Delay	3.0	0.8	5.8	8.0	43.6	12.5
LOS	A	A	A	A	D	B
Approach Delay	2.8			7.9	28.8	
Approach LOS	A			A	C	
Queue Length 50th (m)	14.5	0.2	2.6	49.7	11.3	0.0
Queue Length 95th (m)	21.4	0.9	11.2	120.3	19.6	8.9
Internal Link Dist (m)	147.1			145.1	104.6	
Turn Bay Length (m)		20.0	65.0		30.0	
Base Capacity (vph)	2583	1184	412	2560	385	382
Starvation Cap Reductn	0	0	0	444	0	0
Spillback Cap Reductn	0	0	0	26	0	0
Storage Cap Reductn	0	0	0	0	0	0
Reduced v/c Ratio	0.37	0.08	0.18	0.75	0.17	0.16

Intersection Summary

Area Type: Other
 Cycle Length: 100
 Actuated Cycle Length: 100
 Offset: 88 (88%), Referenced to phase 2:EBT and 6:WBTL, Start of Green
 Natural Cycle: 75
 Control Type: Actuated-Coordinated
 Maximum v/c Ratio: 0.62
 Intersection Signal Delay: 6.9
 Intersection Capacity Utilization 61.5%
 Analysis Period (min) 15
 Intersection LOS: A
 ICU Level of Service B

Splits and Phases: 2: 160m W of Conroy & Walkley



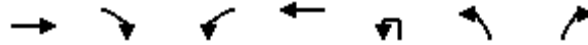

Lane Group	EBT	EBR	WBL	WBT	NBU	NBL	NBR
Lane Configurations	↑↑	↑	↑↑	↑↑		↑↑	↑
Traffic Volume (vph)	794	267	246	991	14	683	462
Future Volume (vph)	794	267	246	991	14	683	462
Ideal Flow (vphpl)	1800	1800	1800	1800	1800	1800	1800
Storage Length (m)		75.0	200.0			0.0	0.0
Storage Lanes		1	2			2	1
Taper Length (m)			50.0			10.0	
Lane Util. Factor	0.95	1.00	0.97	0.95	0.95	0.97	1.00
Ped Bike Factor		0.98	0.99				0.98
Fr _t		0.850					0.850
Fl _t Protected			0.950			0.950	
Satd. Flow (prot)	3161	1455	3066	3161	0	3186	1455
Fl _t Permitted			0.950			0.950	
Satd. Flow (perm)	3161	1419	3046	3161	0	3186	1430
Right Turn on Red		Yes					Yes
Satd. Flow (RTOR)		267					358
Link Speed (k/h)	50			50		60	
Link Distance (m)	169.1			271.7		348.5	
Travel Time (s)	12.2			19.6		20.9	
Confl. Peds. (#/hr)		10	10				3
Confl. Bikes (#/hr)		1					1
Peak Hour Factor	1.00	1.00	1.00	1.00	1.00	1.00	1.00
Heavy Vehicles (%)	7%	4%	7%	7%	2%	3%	4%
Adj. Flow (vph)	794	267	246	991	14	683	462
Shared Lane Traffic (%)							
Lane Group Flow (vph)	794	267	246	991	0	697	462
Enter Blocked Intersection	No	No	No	No	No	No	No
Lane Alignment	Left	R NA	Left	Left	R NA	L NA	R NA
Median Width(m)	7.0			9.0		10.5	
Link Offset(m)	0.0			0.0		0.0	
Crosswalk Width(m)	5.0			5.0		5.0	
Two way Left Turn Lane							
Headway Factor	1.09	1.09	1.09	1.09	1.09	1.09	1.09
Turning Speed (k/h)		14	24		14	24	14
Number of Detectors	2	1	1	2	1	1	1
Detector Template	Thru	Right	Left	Thru	Left	Left	Right
Leading Detector (m)	30.5	6.1	6.1	30.5	6.1	6.1	6.1
Trailing Detector (m)	0.0	0.0	0.0	0.0	0.0	0.0	0.0
Detector 1 Position(m)	0.0	0.0	0.0	0.0	0.0	0.0	0.0
Detector 1 Size(m)	1.8	6.1	6.1	1.8	6.1	6.1	6.1
Detector 1 Type	Cl+Ex	Cl+Ex	Cl+Ex	Cl+Ex	Cl+Ex	Cl+Ex	Cl+Ex
Detector 1 Channel							
Detector 1 Extend (s)	0.0	0.0	0.0	0.0	0.0	0.0	0.0
Detector 1 Queue (s)	0.0	0.0	0.0	0.0	0.0	0.0	0.0
Detector 1 Delay (s)	0.0	0.0	0.0	0.0	0.0	0.0	0.0
Detector 2 Position(m)	28.7			28.7			
Detector 2 Size(m)	1.8			1.8			
Detector 2 Type	Cl+Ex			Cl+Ex			
Detector 2 Channel							
Detector 2 Extend (s)	0.0			0.0			
Turn Type	NA	Perm	Prot	NA	Perm	Prot	Perm
Protected Phases	2		1	6		8	
Permitted Phases		2			8		8
Detector Phase	2	2	1	6	8	8	8



Lane Group	EBT	EBR	WBL	WBT	NBU	NBL	NBR
Switch Phase							
Minimum Initial (s)	10.0	10.0	5.0	10.0	5.0	5.0	5.0
Minimum Split (s)	36.4	36.4	16.0	24.7	30.4	30.4	30.4
Total Split (s)	55.0	55.0	25.0	80.0	40.0	40.0	40.0
Total Split (%)	45.8%	45.8%	20.8%	66.7%	33.3%	33.3%	33.3%
Maximum Green (s)	48.6	48.6	18.8	73.6	33.6	33.6	33.6
Yellow Time (s)	3.7	3.7	3.3	3.7	3.7	3.7	3.7
All-Red Time (s)	2.7	2.7	2.9	2.7	2.7	2.7	2.7
Lost Time Adjust (s)	0.0	0.0	0.0	0.0		0.0	0.0
Total Lost Time (s)	6.4	6.4	6.2	6.4		6.4	6.4
Lead/Lag	Lag	Lag	Lead				
Lead-Lag Optimize?	Yes	Yes	Yes				
Vehicle Extension (s)	3.0	3.0	3.0	3.0	3.0	3.0	3.0
Recall Mode	C-Max	C-Max	None	C-Max	None	None	None
Walk Time (s)	10.0	10.0			7.0	7.0	7.0
Flash Dont Walk (s)	20.0	20.0			17.0	17.0	17.0
Pedestrian Calls (#/hr)	10	10			5	5	5
Act Effct Green (s)	55.1	55.1	14.8	76.1		31.1	31.1
Actuated g/C Ratio	0.46	0.46	0.12	0.63		0.26	0.26
v/c Ratio	0.55	0.34	0.65	0.49		0.84	0.73
Control Delay	26.3	3.9	58.0	13.1		52.4	16.5
Queue Delay	0.0	0.0	0.0	0.0		0.0	0.0
Total Delay	26.3	3.9	58.0	13.1		52.4	16.5
LOS	C	A	E	B		D	B
Approach Delay	20.7			22.0		38.1	
Approach LOS	C			C		D	
Queue Length 50th (m)	65.7	0.0	26.5	58.3		72.6	18.2
Queue Length 95th (m)	90.0	14.6	37.4	74.5		92.2	54.7
Internal Link Dist (m)	145.1			247.7		324.5	
Turn Bay Length (m)		75.0	200.0				
Base Capacity (vph)	1450	795	480	2004		892	658
Starvation Cap Reductn	0	0	0	0		0	0
Spillback Cap Reductn	0	0	0	0		0	0
Storage Cap Reductn	0	0	0	0		0	0
Reduced v/c Ratio	0.55	0.34	0.51	0.49		0.78	0.70

Intersection Summary

Area Type: Other
 Cycle Length: 120
 Actuated Cycle Length: 120
 Offset: 43 (36%), Referenced to phase 2:EBT and 6:WBT, Start of Green
 Natural Cycle: 85
 Control Type: Actuated-Coordinated
 Maximum v/c Ratio: 0.84
 Intersection Signal Delay: 27.0 Intersection LOS: C
 Intersection Capacity Utilization 69.2% ICU Level of Service C
 Analysis Period (min) 15

Splits and Phases: 3: Conroy & Walkley



4: Conroy & St. Laurent
AM Peak Hour

2510 St. Laurent Boulevard
2024 Background Traffic

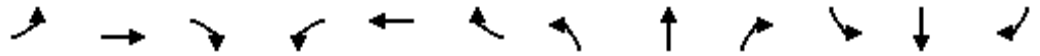

Lane Group	EBL	EBT	EBR	WBL	WBT	WBR	NBL	NBT	NBR	SBL	SBT	SBR
Lane Configurations												
Traffic Volume (vph)	6	65	81	63	43	25	192	1187	199	87	370	53
Future Volume (vph)	6	65	81	63	43	25	192	1187	199	87	370	53
Ideal Flow (vphpl)	1800	1800	1800	1800	1800	1800	1800	1800	1800	1800	1800	1800
Storage Length (m)	45.0		50.0	55.0		55.0	0.0		0.0	110.0		0.0
Storage Lanes	1		1	1		1	1		0	1		0
Taper Length (m)	40.0			40.0			10.0			25.0		
Lane Util. Factor	1.00	1.00	1.00	1.00	1.00	1.00	1.00	0.91	0.91	1.00	0.95	0.95
Ped Bike Factor	1.00		0.98	0.99		0.98	0.98	0.99		1.00	0.99	
Fr _t			0.850			0.850		0.978			0.981	
Fl _t Protected	0.950			0.950			0.950			0.950		
Satd. Flow (prot)	1353	1695	1427	1409	1589	1351	1642	4617	0	1674	3167	0
Fl _t Permitted	0.729			0.715			0.505			0.166		
Satd. Flow (perm)	1033	1695	1395	1050	1589	1328	859	4617	0	291	3167	0
Right Turn on Red			Yes			Yes			Yes			Yes
Satd. Flow (RTOR)			81			36						
Link Speed (k/h)		50			50			60			60	
Link Distance (m)		197.7			271.8			372.7			348.5	
Travel Time (s)		14.2			19.6			22.4			20.9	
Confl. Peds. (#/hr)	6		13	13		6	14		21	21		14
Confl. Bikes (#/hr)												25
Peak Hour Factor	1.00	1.00	1.00	1.00	1.00	1.00	1.00	1.00	1.00	1.00	1.00	1.00
Heavy Vehicles (%)	25%	5%	6%	20%	12%	12%	3%	2%	2%	1%	4%	3%
Adj. Flow (vph)	6	65	81	63	43	25	192	1187	199	87	370	53
Shared Lane Traffic (%)												
Lane Group Flow (vph)	6	65	81	63	43	25	192	1386	0	87	423	0
Enter Blocked Intersection	No	No	No	No	No	No	No	No	No	No	No	No
Lane Alignment	L NA	Left	R NA	L NA	Left	R NA	Left	Left	Right	L NA	Left	R NA
Median Width(m)		3.5			3.5			7.0			6.0	
Link Offset(m)		0.0			0.0			0.0			0.0	
Crosswalk Width(m)		5.0			5.0			5.0			5.0	
Two way Left Turn Lane												
Headway Factor	1.09	1.09	1.09	1.09	1.09	1.09	1.09	1.09	1.09	1.09	1.09	1.09
Turning Speed (k/h)	24		14	24		14	24		14	24		14
Number of Detectors	1	2	1	1	2	1	1	2		1	2	
Detector Template	Left	Thru	Right	Left	Thru	Right	Left	Thru		Left	Thru	
Leading Detector (m)	6.1	30.5	6.1	6.1	30.5	6.1	6.1	30.5		6.1	30.5	
Trailing Detector (m)	0.0	0.0	0.0	0.0	0.0	0.0	0.0	0.0		0.0	0.0	
Detector 1 Position(m)	0.0	0.0	0.0	0.0	0.0	0.0	0.0	0.0		0.0	0.0	
Detector 1 Size(m)	6.1	1.8	6.1	6.1	1.8	6.1	6.1	1.8		6.1	1.8	
Detector 1 Type	Cl+Ex	Cl+Ex	Cl+Ex	Cl+Ex	Cl+Ex	Cl+Ex	Cl+Ex	Cl+Ex		Cl+Ex	Cl+Ex	
Detector 1 Channel												
Detector 1 Extend (s)	0.0	0.0	0.0	0.0	0.0	0.0	0.0	0.0		0.0	0.0	
Detector 1 Queue (s)	0.0	0.0	0.0	0.0	0.0	0.0	0.0	0.0		0.0	0.0	
Detector 1 Delay (s)	0.0	0.0	0.0	0.0	0.0	0.0	0.0	0.0		0.0	0.0	
Detector 2 Position(m)		28.7			28.7			28.7			28.7	
Detector 2 Size(m)		1.8			1.8			1.8			1.8	
Detector 2 Type		Cl+Ex			Cl+Ex			Cl+Ex			Cl+Ex	
Detector 2 Channel												
Detector 2 Extend (s)		0.0			0.0			0.0			0.0	
Turn Type	Perm	NA	Perm	Perm	NA	Perm	Perm	NA		Perm	NA	
Protected Phases		4			8			2			6	
Permitted Phases	4		4	8		8	2			6		
Detector Phase	4	4	4	8	8	8	2	2		6	6	

4: Conroy & St. Laurent
AM Peak Hour

2510 St. Laurent Boulevard
2024 Background Traffic

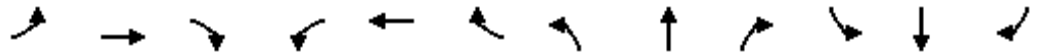

Lane Group	EBL	EBT	EBR	WBL	WBT	WBR	NBL	NBT	NBR	SBL	SBT	SBR
Switch Phase												
Minimum Initial (s)	10.0	10.0	10.0	10.0	10.0	10.0	10.0	10.0		10.0	10.0	
Minimum Split (s)	43.9	43.9	43.9	43.9	43.9	43.9	30.3	30.3		30.3	30.3	
Total Split (s)	44.0	44.0	44.0	44.0	44.0	44.0	56.0	56.0		56.0	56.0	
Total Split (%)	44.0%	44.0%	44.0%	44.0%	44.0%	44.0%	56.0%	56.0%		56.0%	56.0%	
Maximum Green (s)	37.1	37.1	37.1	37.1	37.1	37.1	49.7	49.7		49.7	49.7	
Yellow Time (s)	3.3	3.3	3.3	3.3	3.3	3.3	3.7	3.7		3.7	3.7	
All-Red Time (s)	3.6	3.6	3.6	3.6	3.6	3.6	2.6	2.6		2.6	2.6	
Lost Time Adjust (s)	0.0	0.0	0.0	0.0	0.0	0.0	0.0	0.0		0.0	0.0	
Total Lost Time (s)	6.9	6.9	6.9	6.9	6.9	6.9	6.3	6.3		6.3	6.3	
Lead/Lag												
Lead-Lag Optimize?												
Vehicle Extension (s)	3.0	3.0	3.0	3.0	3.0	3.0	3.0	3.0		3.0	3.0	
Recall Mode	None	None	None	None	None	None	C-Max	C-Max		C-Max	C-Max	
Walk Time (s)	7.0	7.0	7.0	7.0	7.0	7.0	7.0	7.0		7.0	7.0	
Flash Dont Walk (s)	30.0	30.0	30.0	30.0	30.0	30.0	17.0	17.0		17.0	17.0	
Pedestrian Calls (#/hr)	15	15	15	10	10	10	20	20		15	15	
Act Effct Green (s)	21.1	21.1	21.1	21.1	21.1	21.1	70.4	70.4		70.4	70.4	
Actuated g/C Ratio	0.21	0.21	0.21	0.21	0.21	0.21	0.70	0.70		0.70	0.70	
v/c Ratio	0.03	0.18	0.23	0.29	0.13	0.08	0.32	0.42		0.43	0.19	
Control Delay	23.2	28.5	7.1	31.8	27.4	5.2	13.0	10.4		23.6	8.6	
Queue Delay	0.0	0.0	0.0	0.0	0.0	0.0	0.0	0.0		0.0	0.0	
Total Delay	23.2	28.5	7.1	31.8	27.4	5.2	13.0	10.4		23.6	8.6	
LOS	C	C	A	C	C	A	B	B		C	A	
Approach Delay		16.9			25.3			10.7			11.2	
Approach LOS		B			C			B			B	
Queue Length 50th (m)	0.9	10.9	1.1	10.8	7.1	0.0	9.0	25.0		4.5	8.7	
Queue Length 95th (m)	m2.8	16.6	9.2	16.0	11.5	3.5	38.8	73.0		#33.1	29.6	
Internal Link Dist (m)		173.7			247.8			348.7			324.5	
Turn Bay Length (m)	45.0		50.0	55.0		55.0				110.0		
Base Capacity (vph)	383	628	568	389	589	515	604	3262		204	2235	
Starvation Cap Reductn	0	0	0	0	0	0	0	0		0	0	
Spillback Cap Reductn	0	0	0	0	0	0	0	0		0	0	
Storage Cap Reductn	0	0	0	0	0	0	0	0		0	0	
Reduced v/c Ratio	0.02	0.10	0.14	0.16	0.07	0.05	0.32	0.42		0.43	0.19	

Intersection Summary

Area Type: Other
 Cycle Length: 100
 Actuated Cycle Length: 100
 Offset: 23 (23%), Referenced to phase 2:NBT and 6:SBTL, Start of Green
 Natural Cycle: 90
 Control Type: Actuated-Coordinated
 Maximum v/c Ratio: 0.43
 Intersection Signal Delay: 12.0 Intersection LOS: B
 Intersection Capacity Utilization 70.0% ICU Level of Service C
 Analysis Period (min) 15
 # 95th percentile volume exceeds capacity, queue may be longer.
 Queue shown is maximum after two cycles.
 m Volume for 95th percentile queue is metered by upstream signal.

Splits and Phases: 4: Conroy & St. Laurent

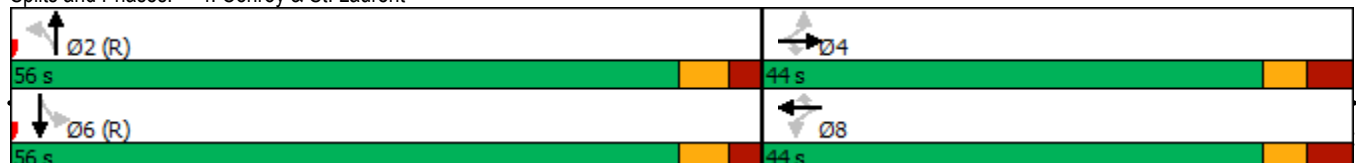



Lane Group	WBL	WBR	NBT	NBR	SBL	SBT
Lane Configurations						
Traffic Volume (vph)	75	40	71	22	69	176
Future Volume (vph)	75	40	71	22	69	176
Ideal Flow (vphpl)	1800	1800	1800	1800	1800	1800
Lane Util. Factor	1.00	1.00	1.00	1.00	1.00	1.00
Ped Bike Factor						
Frt	0.953		0.968			
Flt Protected	0.968					0.986
Satd. Flow (prot)	1563	0	1498	0	0	1678
Flt Permitted	0.968					0.986
Satd. Flow (perm)	1563	0	1498	0	0	1678
Link Speed (k/h)	50		50			50
Link Distance (m)	137.6		234.0			146.3
Travel Time (s)	9.9		16.8			10.5
Confl. Peds. (#/hr)				5	5	
Confl. Bikes (#/hr)		1				
Peak Hour Factor	1.00	1.00	1.00	1.00	1.00	1.00
Heavy Vehicles (%)	4%	7%	15%	15%	6%	4%
Adj. Flow (vph)	75	40	71	22	69	176
Shared Lane Traffic (%)						
Lane Group Flow (vph)	115	0	93	0	0	245
Enter Blocked Intersection	No	No	No	No	No	No
Lane Alignment	Left	Right	Left	Right	Left	Left
Median Width(m)	3.5		0.0			0.0
Link Offset(m)	0.0		0.0			0.0
Crosswalk Width(m)	2.0		10.0			10.0
Two way Left Turn Lane						
Headway Factor	1.09	1.09	1.09	1.09	1.09	1.09
Turning Speed (k/h)	24	14		14	24	
Sign Control	Stop		Free			Free

Intersection Summary

Area Type: Other

Control Type: Unsignalized

Intersection Capacity Utilization 34.1% ICU Level of Service A

Analysis Period (min) 15

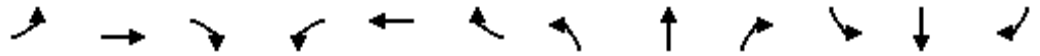

Lane Group	EBL	EBT	EBR	WBL	WBT	WBR	NBL	NBT	NBR	SBL	SBT	SBR
Lane Configurations												
Traffic Volume (vph)	27	1405	100	18	1424	70	162	5	70	92	104	50
Future Volume (vph)	27	1405	100	18	1424	70	162	5	70	92	104	50
Ideal Flow (vphpl)	1800	1800	1800	1800	1800	1800	1800	1800	1800	1800	1800	1800
Storage Length (m)	40.0		0.0	50.0		0.0	35.0		0.0	30.0		0.0
Storage Lanes	1		0	1		0	1		0	1		0
Taper Length (m)	25.0			30.0			25.0			30.0		
Lane Util. Factor	1.00	0.95	0.95	1.00	0.95	0.95	1.00	1.00	1.00	1.00	1.00	1.00
Ped Bike Factor	1.00	1.00		1.00	1.00		1.00				1.00	
Frt		0.990			0.993			0.860			0.951	
Flt Protected	0.950			0.950			0.950			0.950		
Satd. Flow (prot)	1674	3242	0	1674	3291	0	1674	1502	0	1674	1652	0
Flt Permitted	0.129			0.127			0.594			0.708		
Satd. Flow (perm)	227	3242	0	224	3291	0	1045	1502	0	1248	1652	0
Right Turn on Red			Yes			Yes			Yes			Yes
Satd. Flow (RTOR)		12			8			50			22	
Link Speed (k/h)		50			50			50			50	
Link Distance (m)		402.0			171.1			100.3			281.0	
Travel Time (s)		28.9			12.3			7.2			20.2	
Confl. Peds. (#/hr)	1		10	10		1	2					2
Confl. Bikes (#/hr)			1									
Peak Hour Factor	1.00	1.00	1.00	1.00	1.00	1.00	1.00	1.00	1.00	1.00	1.00	1.00
Heavy Vehicles (%)	1%	3%	3%	1%	2%	1%	1%	1%	2%	1%	1%	4%
Adj. Flow (vph)	27	1405	100	18	1424	70	162	5	70	92	104	50
Shared Lane Traffic (%)												
Lane Group Flow (vph)	27	1505	0	18	1494	0	162	75	0	92	154	0
Enter Blocked Intersection	No	No	No	No	No	No	No	No	No	No	No	No
Lane Alignment	L NA	Left	R NA	Left	Left	Right	L NA	Left	R NA	L NA	Left	R NA
Median Width(m)		5.0			5.0			3.5			3.5	
Link Offset(m)		0.0			0.0			0.0			0.0	
Crosswalk Width(m)		5.0			5.0			5.0			5.0	
Two way Left Turn Lane												
Headway Factor	1.09	1.09	1.09	1.09	1.09	1.09	1.09	1.09	1.09	1.09	1.09	1.09
Turning Speed (k/h)	24		14	24		14	24		14	24		14
Number of Detectors	1	2		1	2		1	2		1	2	
Detector Template	Left	Thru		Left	Thru		Left	Thru		Left	Thru	
Leading Detector (m)	6.1	30.5		6.1	30.5		6.1	30.5		6.1	30.5	
Trailing Detector (m)	0.0	0.0		0.0	0.0		0.0	0.0		0.0	0.0	
Detector 1 Position(m)	0.0	0.0		0.0	0.0		0.0	0.0		0.0	0.0	
Detector 1 Size(m)	6.1	1.8		6.1	1.8		6.1	1.8		6.1	1.8	
Detector 1 Type	Cl+Ex	Cl+Ex		Cl+Ex	Cl+Ex		Cl+Ex	Cl+Ex		Cl+Ex	Cl+Ex	
Detector 1 Channel												
Detector 1 Extend (s)	0.0	0.0		0.0	0.0		0.0	0.0		0.0	0.0	
Detector 1 Queue (s)	0.0	0.0		0.0	0.0		0.0	0.0		0.0	0.0	
Detector 1 Delay (s)	0.0	0.0		0.0	0.0		0.0	0.0		0.0	0.0	
Detector 2 Position(m)		28.7			28.7			28.7			28.7	
Detector 2 Size(m)		1.8			1.8			1.8			1.8	
Detector 2 Type		Cl+Ex			Cl+Ex			Cl+Ex			Cl+Ex	
Detector 2 Channel												
Detector 2 Extend (s)		0.0			0.0			0.0			0.0	
Turn Type	Perm	NA		Perm	NA		Perm	NA		Perm	NA	
Protected Phases		2			6			8			4	
Permitted Phases	2			6			8			4		
Detector Phase	2	2		6	6		8	8		4	4	



Lane Group	EBL	EBT	EBR	WBL	WBT	WBR	NBL	NBT	NBR	SBL	SBT	SBR
Switch Phase												
Minimum Initial (s)	10.0	10.0		10.0	10.0		10.0	10.0		10.0	10.0	
Minimum Split (s)	35.9	35.9		35.9	35.9		36.2	36.2		36.2	36.2	
Total Split (s)	74.0	74.0		74.0	74.0		36.0	36.0		36.0	36.0	
Total Split (%)	67.3%	67.3%		67.3%	67.3%		32.7%	32.7%		32.7%	32.7%	
Maximum Green (s)	68.1	68.1		68.1	68.1		29.8	29.8		29.8	29.8	
Yellow Time (s)	3.3	3.3		3.3	3.3		3.3	3.3		3.3	3.3	
All-Red Time (s)	2.6	2.6		2.6	2.6		2.9	2.9		2.9	2.9	
Lost Time Adjust (s)	0.0	0.0		0.0	0.0		0.0	0.0		0.0	0.0	
Total Lost Time (s)	5.9	5.9		5.9	5.9		6.2	6.2		6.2	6.2	
Lead/Lag												
Lead-Lag Optimize?												
Vehicle Extension (s)	3.0	3.0		3.0	3.0		3.0	3.0		3.0	3.0	
Recall Mode	C-Max	C-Max		C-Max	C-Max		None	None		None	None	
Walk Time (s)	15.0	15.0		15.0	15.0		10.0	10.0		10.0	10.0	
Flash Dont Walk (s)	15.0	15.0		15.0	15.0		20.0	20.0		20.0	20.0	
Pedestrian Calls (#/hr)	10	10		5	5		5	5		5	5	
Act Effct Green (s)	76.7	76.7		76.7	76.7		21.2	21.2		21.2	21.2	
Actuated g/C Ratio	0.70	0.70		0.70	0.70		0.19	0.19		0.19	0.19	
v/c Ratio	0.17	0.66		0.12	0.65		0.81	0.23		0.38	0.46	
Control Delay	11.0	12.3		8.3	10.6		69.5	16.0		41.4	36.4	
Queue Delay	0.0	0.0		0.0	0.0		0.0	0.0		0.0	0.0	
Total Delay	11.0	12.3		8.3	10.6		69.5	16.0		41.4	36.4	
LOS	B	B		A	B		E	B		D	D	
Approach Delay		12.2			10.5			52.6			38.3	
Approach LOS		B			B			D			D	
Queue Length 50th (m)	1.6	78.3		1.1	55.1		30.8	4.1		16.0	23.1	
Queue Length 95th (m)	6.8	127.7		m2.0	50.3		48.4	13.8		27.3	37.3	
Internal Link Dist (m)		378.0			147.1			76.3			257.0	
Turn Bay Length (m)	40.0			50.0			35.0			30.0		
Base Capacity (vph)	158	2264		156	2297		283	443		338	463	
Starvation Cap Reductn	0	0		0	0		0	0		0	0	
Spillback Cap Reductn	0	0		0	0		0	0		0	0	
Storage Cap Reductn	0	0		0	0		0	0		0	0	
Reduced v/c Ratio	0.17	0.66		0.12	0.65		0.57	0.17		0.27	0.33	

Intersection Summary

Area Type: Other
 Cycle Length: 110
 Actuated Cycle Length: 110
 Offset: 20 (18%), Referenced to phase 2:EBTL and 6:WBTL, Start of Green
 Natural Cycle: 80
 Control Type: Actuated-Coordinated
 Maximum v/c Ratio: 0.81
 Intersection Signal Delay: 16.0 Intersection LOS: B
 Intersection Capacity Utilization 79.2% ICU Level of Service D
 Analysis Period (min) 15
 m Volume for 95th percentile queue is metered by upstream signal.

Splits and Phases: 1: Don Reid/Ryder & Walkley

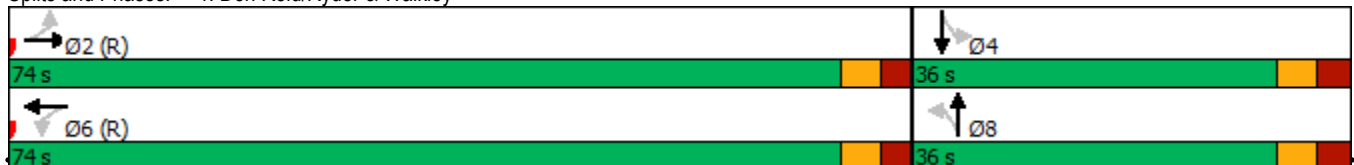



Lane Group	EBT	EBR	WBL	WBT	NBL	NBR
Lane Configurations	↑↑	↑	↓	↑↑	↓	↑
Traffic Volume (vph)	1582	64	36	1447	49	41
Future Volume (vph)	1582	64	36	1447	49	41
Ideal Flow (vphpl)	1800	1800	1800	1800	1800	1800
Storage Length (m)		20.0	65.0		30.0	0.0
Storage Lanes		1	1		1	1
Taper Length (m)			25.0		30.0	
Lane Util. Factor	0.95	1.00	1.00	0.95	1.00	1.00
Ped Bike Factor		0.97	1.00			0.99
Frt		0.850				0.850
Flt Protected			0.950		0.950	
Satd. Flow (prot)	3252	1483	1642	3316	1658	1483
Flt Permitted			0.136		0.950	
Satd. Flow (perm)	3252	1441	235	3316	1658	1463
Right Turn on Red		Yes				Yes
Satd. Flow (RTOR)		30				41
Link Speed (k/h)	50			50	50	
Link Distance (m)	171.1			169.1	128.6	
Travel Time (s)	12.3			12.2	9.3	
Confl. Peds. (#/hr)		5	5			1
Peak Hour Factor	1.00	1.00	1.00	1.00	1.00	1.00
Heavy Vehicles (%)	4%	2%	3%	2%	2%	2%
Adj. Flow (vph)	1582	64	36	1447	49	41
Shared Lane Traffic (%)						
Lane Group Flow (vph)	1582	64	36	1447	49	41
Enter Blocked Intersection	No	No	No	No	No	No
Lane Alignment	Left	Right	L NA	Left	L NA	R NA
Median Width(m)	3.5			5.0	3.5	
Link Offset(m)	0.0			0.0	0.0	
Crosswalk Width(m)	5.0			5.0	5.0	
Two way Left Turn Lane						
Headway Factor	1.09	1.09	1.09	1.09	1.09	1.09
Turning Speed (k/h)		14	24		24	14
Number of Detectors	2	1	1	2	1	1
Detector Template	Thru	Right	Left	Thru	Left	Right
Leading Detector (m)	30.5	6.1	6.1	30.5	6.1	6.1
Trailing Detector (m)	0.0	0.0	0.0	0.0	0.0	0.0
Detector 1 Position(m)	0.0	0.0	0.0	0.0	0.0	0.0
Detector 1 Size(m)	1.8	6.1	6.1	1.8	6.1	6.1
Detector 1 Type	CI+Ex	CI+Ex	CI+Ex	CI+Ex	CI+Ex	CI+Ex
Detector 1 Channel						
Detector 1 Extend (s)	0.0	0.0	0.0	0.0	0.0	0.0
Detector 1 Queue (s)	0.0	0.0	0.0	0.0	0.0	0.0
Detector 1 Delay (s)	0.0	0.0	0.0	0.0	0.0	0.0
Detector 2 Position(m)	28.7			28.7		
Detector 2 Size(m)	1.8			1.8		
Detector 2 Type	CI+Ex			CI+Ex		
Detector 2 Channel						
Detector 2 Extend (s)	0.0			0.0		
Turn Type	NA	Perm	Perm	NA	Prot	Perm
Protected Phases	2			6	8	
Permitted Phases		2	6			8
Detector Phase	2	2	6	6	8	8
Switch Phase						









Lane Group	EBT	EBR	WBL	WBT	NBL	NBR
Minimum Initial (s)	10.0	10.0	10.0	10.0	5.0	5.0
Minimum Split (s)	37.0	37.0	37.0	37.0	29.0	29.0
Total Split (s)	81.0	81.0	81.0	81.0	29.0	29.0
Total Split (%)	73.6%	73.6%	73.6%	73.6%	26.4%	26.4%
Maximum Green (s)	75.0	75.0	75.0	75.0	23.0	23.0
Yellow Time (s)	3.3	3.3	3.3	3.3	3.3	3.3
All-Red Time (s)	2.7	2.7	2.7	2.7	2.7	2.7
Lost Time Adjust (s)	0.0	0.0	0.0	0.0	0.0	0.0
Total Lost Time (s)	6.0	6.0	6.0	6.0	6.0	6.0
Lead/Lag						
Lead-Lag Optimize?						
Vehicle Extension (s)	3.0	3.0	3.0	3.0	3.0	3.0
Recall Mode	C-Max	C-Max	C-Max	C-Max	None	None
Walk Time (s)	18.0	18.0			7.0	7.0
Flash Dont Walk (s)	13.0	13.0			16.0	16.0
Pedestrian Calls (#/hr)	5	5			5	5
Act Effct Green (s)	90.6	90.6	90.6	90.6	10.9	10.9
Actuated g/C Ratio	0.82	0.82	0.82	0.82	0.10	0.10
v/c Ratio	0.59	0.05	0.19	0.53	0.30	0.23
Control Delay	2.1	0.7	7.7	6.6	48.0	15.0
Queue Delay	0.0	0.0	0.0	0.1	0.0	0.0
Total Delay	2.1	0.7	7.7	6.7	48.0	15.0
LOS	A	A	A	A	D	B
Approach Delay	2.1			6.7	32.9	
Approach LOS	A			A	C	
Queue Length 50th (m)	14.5	0.2	0.8	58.0	9.4	0.0
Queue Length 95th (m)	21.3	m0.7	m8.1	111.0	17.5	8.2
Internal Link Dist (m)	147.1			145.1	104.6	
Turn Bay Length (m)		20.0	65.0		30.0	
Base Capacity (vph)	2679	1192	193	2731	346	338
Starvation Cap Reductn	86	0	0	333	0	0
Spillback Cap Reductn	73	0	0	0	0	0
Storage Cap Reductn	0	0	0	0	0	0
Reduced v/c Ratio	0.61	0.05	0.19	0.60	0.14	0.12

Intersection Summary

Area Type: Other
 Cycle Length: 110
 Actuated Cycle Length: 110
 Offset: 25 (23%), Referenced to phase 2:EBT and 6:WBTL, Start of Green
 Natural Cycle: 70
 Control Type: Actuated-Coordinated
 Maximum v/c Ratio: 0.59
 Intersection Signal Delay: 5.1
 Intersection LOS: A
 Intersection Capacity Utilization 60.8%
 ICU Level of Service B
 Analysis Period (min) 15
 m Volume for 95th percentile queue is metered by upstream signal.

Splits and Phases: 2: 160m W of Conroy & Walkley



							
Lane Group	EBT	EBR	WBL	WBT	NBU	NBL	NBR
Lane Configurations	↑↑	↑	↑↑	↑↑		↑↑	↑
Traffic Volume (vph)	1171	452	510	990	42	461	313
Future Volume (vph)	1171	452	510	990	42	461	313
Ideal Flow (vphpl)	1800	1800	1800	1800	1800	1800	1800
Storage Length (m)		75.0	200.0			0.0	0.0
Storage Lanes		1	2			2	1
Taper Length (m)			50.0			10.0	
Lane Util. Factor	0.95	1.00	0.97	0.95	0.95	0.97	1.00
Ped Bike Factor		0.96	0.99				0.97
Fr _t		0.850					0.850
Fl _t Protected			0.950			0.950	
Satd. Flow (prot)	3221	1483	3185	3349	0	3248	1469
Fl _t Permitted			0.950			0.950	
Satd. Flow (perm)	3221	1430	3160	3349	0	3248	1418
Right Turn on Red		Yes					Yes
Satd. Flow (RTOR)		452					313
Link Speed (k/h)	50			50		60	
Link Distance (m)	169.1			271.7		348.5	
Travel Time (s)	12.2			19.6		20.9	
Confl. Peds. (#/hr)		22	22				16
Confl. Bikes (#/hr)		1					1
Peak Hour Factor	1.00	1.00	1.00	1.00	1.00	1.00	1.00
Heavy Vehicles (%)	5%	2%	3%	1%	1%	1%	3%
Adj. Flow (vph)	1171	452	510	990	42	461	313
Shared Lane Traffic (%)							
Lane Group Flow (vph)	1171	452	510	990	0	503	313
Enter Blocked Intersection	No	No	No	No	No	No	No
Lane Alignment	Left	R NA	Left	Left	R NA	L NA	R NA
Median Width(m)	7.0			9.0		10.5	
Link Offset(m)	0.0			0.0		0.0	
Crosswalk Width(m)	5.0			5.0		5.0	
Two way Left Turn Lane							
Headway Factor	1.09	1.09	1.09	1.09	1.09	1.09	1.09
Turning Speed (k/h)		14	24		14	24	14
Number of Detectors	2	1	1	2	1	1	1
Detector Template	Thru	Right	Left	Thru	Left	Left	Right
Leading Detector (m)	30.5	6.1	6.1	30.5	6.1	6.1	6.1
Trailing Detector (m)	0.0	0.0	0.0	0.0	0.0	0.0	0.0
Detector 1 Position(m)	0.0	0.0	0.0	0.0	0.0	0.0	0.0
Detector 1 Size(m)	1.8	6.1	6.1	1.8	6.1	6.1	6.1
Detector 1 Type	Cl+Ex	Cl+Ex	Cl+Ex	Cl+Ex	Cl+Ex	Cl+Ex	Cl+Ex
Detector 1 Channel							
Detector 1 Extend (s)	0.0	0.0	0.0	0.0	0.0	0.0	0.0
Detector 1 Queue (s)	0.0	0.0	0.0	0.0	0.0	0.0	0.0
Detector 1 Delay (s)	0.0	0.0	0.0	0.0	0.0	0.0	0.0
Detector 2 Position(m)	28.7			28.7			
Detector 2 Size(m)	1.8			1.8			
Detector 2 Type	Cl+Ex			Cl+Ex			
Detector 2 Channel							
Detector 2 Extend (s)	0.0			0.0			
Turn Type	NA	Perm	Prot	NA	Perm	Prot	Perm
Protected Phases	2		1	6		8	
Permitted Phases		2			8		8
Detector Phase	2	2	1	6	8	8	8



Lane Group	EBT	EBR	WBL	WBT	NBU	NBL	NBR
Switch Phase							
Minimum Initial (s)	10.0	10.0	5.0	10.0	5.0	5.0	5.0
Minimum Split (s)	36.4	36.4	16.0	24.7	30.4	30.4	30.4
Total Split (s)	51.0	51.0	28.0	79.0	31.0	31.0	31.0
Total Split (%)	46.4%	46.4%	25.5%	71.8%	28.2%	28.2%	28.2%
Maximum Green (s)	44.6	44.6	21.8	72.6	24.6	24.6	24.6
Yellow Time (s)	3.7	3.7	3.3	3.7	3.7	3.7	3.7
All-Red Time (s)	2.7	2.7	2.9	2.7	2.7	2.7	2.7
Lost Time Adjust (s)	0.0	0.0	0.0	0.0		0.0	0.0
Total Lost Time (s)	6.4	6.4	6.2	6.4		6.4	6.4
Lead/Lag	Lag	Lag	Lead				
Lead-Lag Optimize?	Yes	Yes	Yes				
Vehicle Extension (s)	3.0	3.0	3.0	3.0	3.0	3.0	3.0
Recall Mode	C-Max	C-Max	None	C-Max	None	None	None
Walk Time (s)	10.0	10.0			7.0	7.0	7.0
Flash Dont Walk (s)	20.0	20.0			17.0	17.0	17.0
Pedestrian Calls (#/hr)	20	20			15	15	15
Act Effct Green (s)	48.3	48.3	20.9	75.5		21.7	21.7
Actuated g/C Ratio	0.44	0.44	0.19	0.69		0.20	0.20
v/c Ratio	0.83	0.51	0.84	0.43		0.78	0.59
Control Delay	30.7	6.2	56.4	8.7		50.9	9.0
Queue Delay	0.0	0.0	0.0	0.0		0.0	0.0
Total Delay	30.7	6.2	56.4	8.7		50.9	9.0
LOS	C	A	E	A		D	A
Approach Delay	23.9			25.0		34.9	
Approach LOS	C			C		C	
Queue Length 50th (m)	66.8	0.2	49.4	42.6		48.4	0.0
Queue Length 95th (m)	#134.1	31.5	#71.2	56.8		63.7	21.0
Internal Link Dist (m)	145.1			247.7		324.5	
Turn Bay Length (m)		75.0	200.0				
Base Capacity (vph)	1414	881	637	2297		726	560
Starvation Cap Reductn	2	0	0	0		0	0
Spillback Cap Reductn	0	0	0	0		0	0
Storage Cap Reductn	0	0	0	0		0	0
Reduced v/c Ratio	0.83	0.51	0.80	0.43		0.69	0.56

Intersection Summary

Area Type: Other
 Cycle Length: 110
 Actuated Cycle Length: 110
 Offset: 20 (18%), Referenced to phase 2:EBT and 6:WBT, Start of Green
 Natural Cycle: 85
 Control Type: Actuated-Coordinated
 Maximum v/c Ratio: 0.84
 Intersection Signal Delay: 26.6
 Intersection LOS: C
 Intersection Capacity Utilization 82.5%
 ICU Level of Service E
 Analysis Period (min) 15
 # 95th percentile volume exceeds capacity, queue may be longer.
 Queue shown is maximum after two cycles.

Splits and Phases: 3: Conroy & Walkley



4: Conroy & St. Laurent
PM Peak Hour

2510 St. Laurent Boulevard
2024 Background Traffic

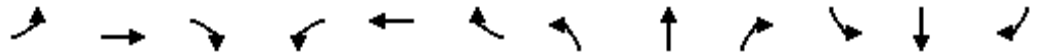

Lane Group	EBL	EBT	EBR	WBL	WBT	WBR	NBL	NBT	NBR	SBL	SBT	SBR
Lane Configurations												
Traffic Volume (vph)	41	77	316	232	34	102	40	567	81	37	1058	13
Future Volume (vph)	41	77	316	232	34	102	40	567	81	37	1058	13
Ideal Flow (vphpl)	1800	1800	1800	1800	1800	1800	1800	1800	1800	1800	1800	1800
Storage Length (m)	45.0		50.0	55.0		55.0	0.0		0.0	110.0		0.0
Storage Lanes	1		1	1		1	1		0	1		0
Taper Length (m)	40.0			40.0			10.0			25.0		
Lane Util. Factor	1.00	1.00	1.00	1.00	1.00	1.00	1.00	0.91	0.91	1.00	0.95	0.95
Ped Bike Factor	1.00		0.98	1.00		0.99	1.00	0.99		0.99	1.00	
Fr _t			0.850			0.850		0.981			0.998	
Fl _t Protected	0.950			0.950			0.950			0.950		
Satd. Flow (prot)	1674	1728	1483	1642	1618	1483	1642	4612	0	1537	3303	0
Fl _t Permitted	0.735			0.555			0.174			0.385		
Satd. Flow (perm)	1293	1728	1461	957	1618	1463	300	4612	0	617	3303	0
Right Turn on Red			Yes			Yes			Yes			Yes
Satd. Flow (RTOR)			123			88		29			1	
Link Speed (k/h)		50			50			60			60	
Link Distance (m)		197.7			271.8			372.7			348.5	
Travel Time (s)		14.2			19.6			22.4			20.9	
Confl. Peds. (#/hr)	2		4	4		2	8		12	12		8
Confl. Bikes (#/hr)									4			11
Peak Hour Factor	1.00	1.00	1.00	1.00	1.00	1.00	1.00	1.00	1.00	1.00	1.00	1.00
Heavy Vehicles (%)	1%	3%	2%	3%	10%	2%	3%	2%	8%	10%	2%	12%
Adj. Flow (vph)	41	77	316	232	34	102	40	567	81	37	1058	13
Shared Lane Traffic (%)												
Lane Group Flow (vph)	41	77	316	232	34	102	40	648	0	37	1071	0
Enter Blocked Intersection	No	No	No	No	No	No	No	No	No	No	No	No
Lane Alignment	L NA	Left	R NA	L NA	Left	R NA	Left	Left	Right	L NA	Left	R NA
Median Width(m)		3.5			3.5			7.0			6.0	
Link Offset(m)		0.0			0.0			0.0			0.0	
Crosswalk Width(m)		5.0			5.0			5.0			5.0	
Two way Left Turn Lane												
Headway Factor	1.09	1.09	1.09	1.09	1.09	1.09	1.09	1.09	1.09	1.09	1.09	1.09
Turning Speed (k/h)	24		14	24		14	24		14	24		14
Number of Detectors	1	2	1	1	2	1	1	2		1	2	
Detector Template	Left	Thru	Right	Left	Thru	Right	Left	Thru		Left	Thru	
Leading Detector (m)	6.1	30.5	6.1	6.1	30.5	6.1	6.1	30.5		6.1	30.5	
Trailing Detector (m)	0.0	0.0	0.0	0.0	0.0	0.0	0.0	0.0		0.0	0.0	
Detector 1 Position(m)	0.0	0.0	0.0	0.0	0.0	0.0	0.0	0.0		0.0	0.0	
Detector 1 Size(m)	6.1	1.8	6.1	6.1	1.8	6.1	6.1	1.8		6.1	1.8	
Detector 1 Type	Cl+Ex	Cl+Ex	Cl+Ex	Cl+Ex	Cl+Ex	Cl+Ex	Cl+Ex	Cl+Ex		Cl+Ex	Cl+Ex	
Detector 1 Channel												
Detector 1 Extend (s)	0.0	0.0	0.0	0.0	0.0	0.0	0.0	0.0		0.0	0.0	
Detector 1 Queue (s)	0.0	0.0	0.0	0.0	0.0	0.0	0.0	0.0		0.0	0.0	
Detector 1 Delay (s)	0.0	0.0	0.0	0.0	0.0	0.0	0.0	0.0		0.0	0.0	
Detector 2 Position(m)		28.7			28.7			28.7			28.7	
Detector 2 Size(m)		1.8			1.8			1.8			1.8	
Detector 2 Type		Cl+Ex			Cl+Ex			Cl+Ex			Cl+Ex	
Detector 2 Channel												
Detector 2 Extend (s)		0.0			0.0			0.0			0.0	
Turn Type	Perm	NA	Perm	pm+pt	NA	Perm	Perm	NA		Perm	NA	
Protected Phases		4		3	8			2			6	
Permitted Phases	4		4	8		8	2			6		
Detector Phase	4	4	4	3	8	8	2	2		6	6	

4: Conroy & St. Laurent
PM Peak Hour

2510 St. Laurent Boulevard
2024 Background Traffic

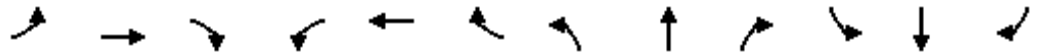

Lane Group	EBL	EBT	EBR	WBL	WBT	WBR	NBL	NBT	NBR	SBL	SBT	SBR
Switch Phase												
Minimum Initial (s)	10.0	10.0	10.0	5.0	10.0	10.0	10.0	10.0		10.0	10.0	
Minimum Split (s)	43.9	43.9	43.9	11.3	43.9	43.9	30.3	30.3		30.3	30.3	
Total Split (s)	44.0	44.0	44.0	15.0	59.0	59.0	36.0	36.0		36.0	36.0	
Total Split (%)	46.3%	46.3%	46.3%	15.8%	62.1%	62.1%	37.9%	37.9%		37.9%	37.9%	
Maximum Green (s)	37.1	37.1	37.1	9.3	52.1	52.1	29.7	29.7		29.7	29.7	
Yellow Time (s)	3.3	3.3	3.3	3.3	3.3	3.3	3.7	3.7		3.7	3.7	
All-Red Time (s)	3.6	3.6	3.6	2.4	3.6	3.6	2.6	2.6		2.6	2.6	
Lost Time Adjust (s)	0.0	0.0	0.0	0.0	0.0	0.0	0.0	0.0		0.0	0.0	
Total Lost Time (s)	6.9	6.9	6.9	5.7	6.9	6.9	6.3	6.3		6.3	6.3	
Lead/Lag	Lag	Lag	Lag	Lead								
Lead-Lag Optimize?	Yes	Yes	Yes	Yes								
Vehicle Extension (s)	3.0	3.0	3.0	3.0	3.0	3.0	3.0	3.0		3.0	3.0	
Recall Mode	None	None	None	None	None	None	C-Max	C-Max		C-Max	C-Max	
Walk Time (s)	7.0	7.0	7.0		7.0	7.0	7.0	7.0		7.0	7.0	
Flash Dont Walk (s)	30.0	30.0	30.0		30.0	30.0	17.0	17.0		17.0	17.0	
Pedestrian Calls (#/hr)	5	5	5		5	5	10	10		10	10	
Act Effct Green (s)	20.8	20.8	20.8	37.0	35.8	35.8	46.0	46.0		46.0	46.0	
Actuated g/C Ratio	0.22	0.22	0.22	0.39	0.38	0.38	0.48	0.48		0.48	0.48	
v/c Ratio	0.14	0.20	0.76	0.53	0.06	0.17	0.28	0.29		0.12	0.67	
Control Delay	26.5	27.9	31.4	23.6	15.3	4.7	27.0	16.3		19.8	24.1	
Queue Delay	0.0	0.0	0.0	0.0	0.0	0.0	0.0	0.0		0.0	0.0	
Total Delay	26.5	27.9	31.4	23.6	15.3	4.7	27.0	16.3		19.8	24.1	
LOS	C	C	C	C	B	A	C	B		B	C	
Approach Delay		30.3			17.6			16.9			24.0	
Approach LOS		C			B			B			C	
Queue Length 50th (m)	5.8	11.0	31.8	28.4	3.7	1.5	3.7	20.8		3.1	66.5	
Queue Length 95th (m)	10.4	16.5	45.0	30.7	6.4	7.4	15.8	40.0		12.0	#139.4	
Internal Link Dist (m)		173.7			247.8			348.7			324.5	
Turn Bay Length (m)	45.0		50.0	55.0		55.0				110.0		
Base Capacity (vph)	504	674	645	440	887	842	145	2246		298	1598	
Starvation Cap Reductn	0	0	0	0	0	0	0	0		0	0	
Spillback Cap Reductn	0	0	0	0	0	0	0	0		0	0	
Storage Cap Reductn	0	0	0	0	0	0	0	0		0	0	
Reduced v/c Ratio	0.08	0.11	0.49	0.53	0.04	0.12	0.28	0.29		0.12	0.67	

Intersection Summary

Area Type: Other
 Cycle Length: 95
 Actuated Cycle Length: 95
 Offset: 2 (2%), Referenced to phase 2:NBTL and 6:SBTL, Start of Green
 Natural Cycle: 90
 Control Type: Actuated-Coordinated
 Maximum v/c Ratio: 0.76
 Intersection Signal Delay: 22.3 Intersection LOS: C
 Intersection Capacity Utilization 82.9% ICU Level of Service E
 Analysis Period (min) 15
 # 95th percentile volume exceeds capacity, queue may be longer.
 Queue shown is maximum after two cycles.

Splits and Phases: 4: Conroy & St. Laurent

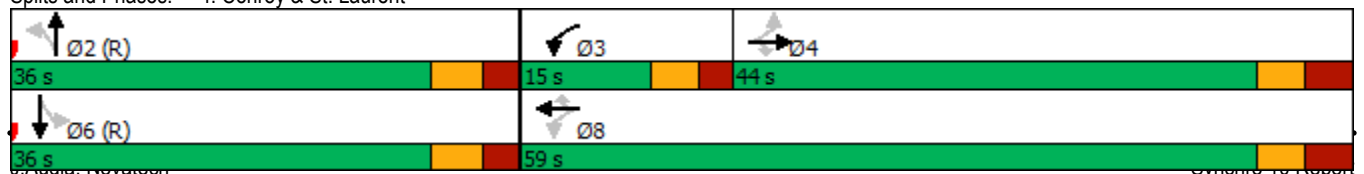



Lane Group	WBL	WBR	NBT	NBR	SBL	SBT
Lane Configurations						
Traffic Volume (vph)	23	56	107	76	151	51
Future Volume (vph)	23	56	107	76	151	51
Ideal Flow (vphpl)	1800	1800	1800	1800	1800	1800
Lane Util. Factor	1.00	1.00	1.00	1.00	1.00	1.00
Ped Bike Factor						
Frt	0.904		0.944			
Flt Protected	0.986					0.964
Satd. Flow (prot)	1481	0	1641	0	0	1588
Flt Permitted	0.986					0.964
Satd. Flow (perm)	1481	0	1641	0	0	1588
Link Speed (k/h)	50		50			50
Link Distance (m)	137.6		234.0			146.3
Travel Time (s)	9.9		16.8			10.5
Confl. Peds. (#/hr)				2	2	
Confl. Bikes (#/hr)		1		4		
Peak Hour Factor	1.00	1.00	1.00	1.00	1.00	1.00
Heavy Vehicles (%)	5%	8%	2%	3%	4%	20%
Adj. Flow (vph)	23	56	107	76	151	51
Shared Lane Traffic (%)						
Lane Group Flow (vph)	79	0	183	0	0	202
Enter Blocked Intersection	No	No	No	No	No	No
Lane Alignment	Left	Right	Left	Right	Left	Left
Median Width(m)	3.5		0.0			0.0
Link Offset(m)	0.0		0.0			0.0
Crosswalk Width(m)	2.0		10.0			10.0
Two way Left Turn Lane						
Headway Factor	1.09	1.09	1.09	1.09	1.09	1.09
Turning Speed (k/h)	24	14		14	24	
Sign Control	Stop		Free			Free

Intersection Summary

Area Type: Other

Control Type: Unsignalized

Intersection Capacity Utilization 37.7%

ICU Level of Service A

Analysis Period (min) 15

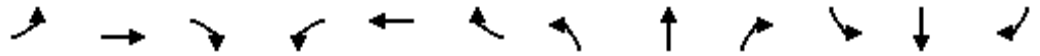

Lane Group	EBL	EBT	EBR	WBL	WBT	WBR	NBL	NBT	NBR	SBL	SBT	SBR
Lane Configurations												
Traffic Volume (vph)	29	1125	164	41	1531	195	78	7	53	49	47	39
Future Volume (vph)	29	1125	164	41	1531	195	78	7	53	49	47	39
Ideal Flow (vphpl)	1800	1800	1800	1800	1800	1800	1800	1800	1800	1800	1800	1800
Storage Length (m)	40.0		0.0	50.0		0.0	35.0		0.0	30.0		0.0
Storage Lanes	1		0	1		0	1		0	1		0
Taper Length (m)	25.0			30.0			25.0			30.0		
Lane Util. Factor	1.00	0.95	0.95	1.00	0.95	0.95	1.00	1.00	1.00	1.00	1.00	1.00
Ped Bike Factor		1.00		1.00	1.00		1.00	0.99			0.99	
Frt		0.981			0.983			0.867			0.932	
Flt Protected	0.950			0.950			0.950			0.950		
Satd. Flow (prot)	1537	3190	0	1642	3172	0	1580	1378	0	1674	1633	0
Flt Permitted	0.101			0.188			0.701			0.718		
Satd. Flow (perm)	163	3190	0	325	3172	0	1165	1378	0	1265	1633	0
Right Turn on Red			Yes			Yes			Yes			Yes
Satd. Flow (RTOR)		27			23			53			31	
Link Speed (k/h)		50			50			50			50	
Link Distance (m)		402.0			171.1			100.3			281.0	
Travel Time (s)		28.9			12.3			7.2			20.2	
Confl. Peds. (#/hr)	1		5	5		1	1					1
Confl. Bikes (#/hr)									1			
Peak Hour Factor	1.00	1.00	1.00	1.00	1.00	1.00	1.00	1.00	1.00	1.00	1.00	1.00
Heavy Vehicles (%)	10%	4%	1%	3%	5%	1%	7%	1%	12%	1%	1%	1%
Adj. Flow (vph)	29	1125	164	41	1531	195	78	7	53	49	47	39
Shared Lane Traffic (%)												
Lane Group Flow (vph)	29	1289	0	41	1726	0	78	60	0	49	86	0
Enter Blocked Intersection	No	No	No	No	No	No	No	No	No	No	No	No
Lane Alignment	L NA	Left	R NA	Left	Left	Right	L NA	Left	R NA	L NA	Left	R NA
Median Width(m)		5.0			5.0			3.5			3.5	
Link Offset(m)		0.0			0.0			0.0			0.0	
Crosswalk Width(m)		5.0			5.0			5.0			5.0	
Two way Left Turn Lane												
Headway Factor	1.09	1.09	1.09	1.09	1.09	1.09	1.09	1.09	1.09	1.09	1.09	1.09
Turning Speed (k/h)	24		14	24		14	24		14	24		14
Number of Detectors	1	2		1	2		1	2		1	2	
Detector Template	Left	Thru		Left	Thru		Left	Thru		Left	Thru	
Leading Detector (m)	6.1	30.5		6.1	30.5		6.1	30.5		6.1	30.5	
Trailing Detector (m)	0.0	0.0		0.0	0.0		0.0	0.0		0.0	0.0	
Detector 1 Position(m)	0.0	0.0		0.0	0.0		0.0	0.0		0.0	0.0	
Detector 1 Size(m)	6.1	1.8		6.1	1.8		6.1	1.8		6.1	1.8	
Detector 1 Type	Cl+Ex	Cl+Ex		Cl+Ex	Cl+Ex		Cl+Ex	Cl+Ex		Cl+Ex	Cl+Ex	
Detector 1 Channel												
Detector 1 Extend (s)	0.0	0.0		0.0	0.0		0.0	0.0		0.0	0.0	
Detector 1 Queue (s)	0.0	0.0		0.0	0.0		0.0	0.0		0.0	0.0	
Detector 1 Delay (s)	0.0	0.0		0.0	0.0		0.0	0.0		0.0	0.0	
Detector 2 Position(m)		28.7			28.7			28.7			28.7	
Detector 2 Size(m)		1.8			1.8			1.8			1.8	
Detector 2 Type		Cl+Ex			Cl+Ex			Cl+Ex			Cl+Ex	
Detector 2 Channel												
Detector 2 Extend (s)		0.0			0.0			0.0			0.0	
Turn Type	Perm	NA		Perm	NA		Perm	NA		Perm	NA	
Protected Phases		2			6			8			4	
Permitted Phases	2			6			8			4		
Detector Phase	2	2		6	6		8	8		4	4	

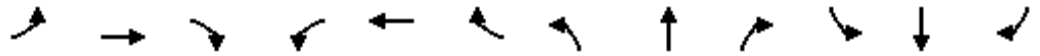

Lane Group	EBL	EBT	EBR	WBL	WBT	WBR	NBL	NBT	NBR	SBL	SBT	SBR
Switch Phase												
Minimum Initial (s)	10.0	10.0		10.0	10.0		10.0	10.0		10.0	10.0	
Minimum Split (s)	35.9	35.9		35.9	35.9		36.2	36.2		36.2	36.2	
Total Split (s)	64.0	64.0		64.0	64.0		36.0	36.0		36.0	36.0	
Total Split (%)	64.0%	64.0%		64.0%	64.0%		36.0%	36.0%		36.0%	36.0%	
Maximum Green (s)	58.1	58.1		58.1	58.1		29.8	29.8		29.8	29.8	
Yellow Time (s)	3.3	3.3		3.3	3.3		3.3	3.3		3.3	3.3	
All-Red Time (s)	2.6	2.6		2.6	2.6		2.9	2.9		2.9	2.9	
Lost Time Adjust (s)	0.0	0.0		0.0	0.0		0.0	0.0		0.0	0.0	
Total Lost Time (s)	5.9	5.9		5.9	5.9		6.2	6.2		6.2	6.2	
Lead/Lag												
Lead-Lag Optimize?												
Vehicle Extension (s)	3.0	3.0		3.0	3.0		3.0	3.0		3.0	3.0	
Recall Mode	C-Max	C-Max		C-Max	C-Max		None	None		None	None	
Walk Time (s)	15.0	15.0		15.0	15.0		10.0	10.0		10.0	10.0	
Flash Dont Walk (s)	15.0	15.0		15.0	15.0		20.0	20.0		20.0	20.0	
Pedestrian Calls (#/hr)	5	5		5	5		5	5		5	5	
Act Effct Green (s)	77.1	77.1		77.1	77.1		15.2	15.2		15.2	15.2	
Actuated g/C Ratio	0.77	0.77		0.77	0.77		0.15	0.15		0.15	0.15	
v/c Ratio	0.23	0.52		0.16	0.70		0.44	0.24		0.26	0.31	
Control Delay	13.4	7.8		6.0	6.8		44.0	12.8		37.6	25.9	
Queue Delay	0.0	0.0		0.0	0.0		0.0	0.0		0.0	0.0	
Total Delay	13.4	7.8		6.0	6.8		44.0	12.8		37.6	25.9	
LOS	B	A		A	A		D	B		D	C	
Approach Delay		7.9			6.8			30.4			30.2	
Approach LOS		A			A			C			C	
Queue Length 50th (m)	1.3	39.0		1.1	28.4		13.3	1.1		8.1	9.1	
Queue Length 95th (m)	9.5	99.2		m2.6	#191.1		21.3	9.1		14.5	17.5	
Internal Link Dist (m)		378.0			147.1			76.3			257.0	
Turn Bay Length (m)	40.0			50.0			35.0			30.0		
Base Capacity (vph)	125	2464		250	2450		347	447		376	508	
Starvation Cap Reductn	0	0		0	20		0	0		0	0	
Spillback Cap Reductn	0	0		0	0		0	0		0	0	
Storage Cap Reductn	0	0		0	0		0	0		0	0	
Reduced v/c Ratio	0.23	0.52		0.16	0.71		0.22	0.13		0.13	0.17	

Intersection Summary

Area Type: Other
 Cycle Length: 100
 Actuated Cycle Length: 100
 Offset: 94 (94%), Referenced to phase 2:EBTL and 6:WBTL, Start of Green
 Natural Cycle: 90
 Control Type: Actuated-Coordinated
 Maximum v/c Ratio: 0.70
 Intersection Signal Delay: 9.2 Intersection LOS: A
 Intersection Capacity Utilization 72.6% ICU Level of Service C
 Analysis Period (min) 15
 # 95th percentile volume exceeds capacity, queue may be longer.
 Queue shown is maximum after two cycles.
 m Volume for 95th percentile queue is metered by upstream signal.

Splits and Phases: 1: Don Reid/Ryder & Walkley



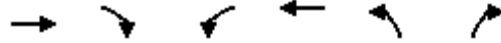

Lane Group	EBT	EBR	WBL	WBT	NBL	NBR
Lane Configurations	↑↑	↑	↑	↑↑	↑	↑
Traffic Volume (vph)	1147	90	74	1719	66	60
Future Volume (vph)	1147	90	74	1719	66	60
Ideal Flow (vphpl)	1800	1800	1800	1800	1800	1800
Storage Length (m)		20.0	65.0		30.0	0.0
Storage Lanes		1	1		1	1
Taper Length (m)			25.0		30.0	
Lane Util. Factor	0.95	1.00	1.00	0.95	1.00	1.00
Ped Bike Factor		0.97	1.00			0.99
Fr _t		0.850				0.850
Fl _t Protected			0.950		0.950	
Satd. Flow (prot)	3221	1498	1674	3191	1674	1483
Fl _t Permitted			0.231		0.950	
Satd. Flow (perm)	3221	1459	407	3191	1674	1462
Right Turn on Red		Yes				Yes
Satd. Flow (RTOR)		59				60
Link Speed (k/h)	50			50	50	
Link Distance (m)	171.1			169.1	128.6	
Travel Time (s)	12.3			12.2	9.3	
Confl. Peds. (#/hr)		4	4			2
Peak Hour Factor	1.00	1.00	1.00	1.00	1.00	1.00
Heavy Vehicles (%)	5%	1%	1%	6%	1%	2%
Adj. Flow (vph)	1147	90	74	1719	66	60
Shared Lane Traffic (%)						
Lane Group Flow (vph)	1147	90	74	1719	66	60
Enter Blocked Intersection	No	No	No	No	No	No
Lane Alignment	Left	Right	L NA	Left	L NA	R NA
Median Width(m)	3.5			5.0	3.5	
Link Offset(m)	0.0			0.0	0.0	
Crosswalk Width(m)	5.0			5.0	5.0	
Two way Left Turn Lane						
Headway Factor	1.09	1.09	1.09	1.09	1.09	1.09
Turning Speed (k/h)		14	24		24	14
Number of Detectors	2	1	1	2	1	1
Detector Template	Thru	Right	Left	Thru	Left	Right
Leading Detector (m)	30.5	6.1	6.1	30.5	6.1	6.1
Trailing Detector (m)	0.0	0.0	0.0	0.0	0.0	0.0
Detector 1 Position(m)	0.0	0.0	0.0	0.0	0.0	0.0
Detector 1 Size(m)	1.8	6.1	6.1	1.8	6.1	6.1
Detector 1 Type	CI+Ex	CI+Ex	CI+Ex	CI+Ex	CI+Ex	CI+Ex
Detector 1 Channel						
Detector 1 Extend (s)	0.0	0.0	0.0	0.0	0.0	0.0
Detector 1 Queue (s)	0.0	0.0	0.0	0.0	0.0	0.0
Detector 1 Delay (s)	0.0	0.0	0.0	0.0	0.0	0.0
Detector 2 Position(m)	28.7			28.7		
Detector 2 Size(m)	1.8			1.8		
Detector 2 Type	CI+Ex			CI+Ex		
Detector 2 Channel						
Detector 2 Extend (s)	0.0			0.0		
Turn Type	NA	Perm	Perm	NA	Prot	Perm
Protected Phases	2			6	8	
Permitted Phases		2	6			8
Detector Phase	2	2	6	6	8	8
Switch Phase						

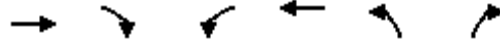

Lane Group	EBT	EBR	WBL	WBT	NBL	NBR
Minimum Initial (s)	10.0	10.0	10.0	10.0	5.0	5.0
Minimum Split (s)	37.0	37.0	37.0	37.0	29.0	29.0
Total Split (s)	71.0	71.0	71.0	71.0	29.0	29.0
Total Split (%)	71.0%	71.0%	71.0%	71.0%	29.0%	29.0%
Maximum Green (s)	65.0	65.0	65.0	65.0	23.0	23.0
Yellow Time (s)	3.3	3.3	3.3	3.3	3.3	3.3
All-Red Time (s)	2.7	2.7	2.7	2.7	2.7	2.7
Lost Time Adjust (s)	0.0	0.0	0.0	0.0	0.0	0.0
Total Lost Time (s)	6.0	6.0	6.0	6.0	6.0	6.0
Lead/Lag						
Lead-Lag Optimize?						
Vehicle Extension (s)	3.0	3.0	3.0	3.0	3.0	3.0
Recall Mode	C-Max	C-Max	C-Max	C-Max	None	None
Walk Time (s)	18.0	18.0			7.0	7.0
Flash Dont Walk (s)	13.0	13.0			16.0	16.0
Pedestrian Calls (#/hr)	5	5			5	5
Act Effct Green (s)	80.2	80.2	80.2	80.2	11.3	11.3
Actuated g/C Ratio	0.80	0.80	0.80	0.80	0.11	0.11
v/c Ratio	0.44	0.08	0.23	0.67	0.35	0.28
Control Delay	3.0	1.0	6.9	8.5	43.6	12.5
Queue Delay	0.0	0.0	0.0	0.6	0.0	0.0
Total Delay	3.0	1.0	6.9	9.0	43.6	12.5
LOS	A	A	A	A	D	B
Approach Delay	2.9			8.9	28.8	
Approach LOS	A			A	C	
Queue Length 50th (m)	18.3	0.3	2.7	58.5	11.3	0.0
Queue Length 95th (m)	23.7	1.1	12.5	142.2	19.6	8.9
Internal Link Dist (m)	147.1			145.1	104.6	
Turn Bay Length (m)		20.0	65.0		30.0	
Base Capacity (vph)	2583	1182	326	2560	385	382
Starvation Cap Reductn	0	0	0	406	0	0
Spillback Cap Reductn	0	0	0	70	0	0
Storage Cap Reductn	0	0	0	0	0	0
Reduced v/c Ratio	0.44	0.08	0.23	0.80	0.17	0.16

Intersection Summary

Area Type: Other
 Cycle Length: 100
 Actuated Cycle Length: 100
 Offset: 88 (88%), Referenced to phase 2:EBT and 6:WBTL, Start of Green
 Natural Cycle: 80
 Control Type: Actuated-Coordinated
 Maximum v/c Ratio: 0.67
 Intersection Signal Delay: 7.4
 Intersection Capacity Utilization 65.3%
 Analysis Period (min) 15
 Intersection LOS: A
 ICU Level of Service C

Splits and Phases: 2: 160m W of Conroy & Walkley





Lane Group	EBT	EBR	WBL	WBT	NBU	NBL	NBR
Lane Configurations	↑↑	↑	↑↑	↑↑		↑↑	↑
Traffic Volume (vph)	987	280	257	1091	14	717	484
Future Volume (vph)	987	280	257	1091	14	717	484
Ideal Flow (vphpl)	1800	1800	1800	1800	1800	1800	1800
Storage Length (m)		75.0	200.0			0.0	0.0
Storage Lanes		1	2			2	1
Taper Length (m)			50.0			10.0	
Lane Util. Factor	0.95	1.00	0.97	0.95	0.95	0.97	1.00
Ped Bike Factor		0.98	0.99				0.98
Fr _t		0.850					0.850
Fl _t Protected			0.950			0.950	
Satd. Flow (prot)	3161	1455	3066	3161	0	3186	1455
Fl _t Permitted			0.950			0.950	
Satd. Flow (perm)	3161	1419	3050	3161	0	3186	1430
Right Turn on Red		Yes					Yes
Satd. Flow (RTOR)		280					332
Link Speed (k/h)	50			50		60	
Link Distance (m)	169.1			271.7		348.5	
Travel Time (s)	12.2			19.6		20.9	
Confl. Peds. (#/hr)		10	10				3
Confl. Bikes (#/hr)		1					1
Peak Hour Factor	1.00	1.00	1.00	1.00	1.00	1.00	1.00
Heavy Vehicles (%)	7%	4%	7%	7%	2%	3%	4%
Adj. Flow (vph)	987	280	257	1091	14	717	484
Shared Lane Traffic (%)							
Lane Group Flow (vph)	987	280	257	1091	0	731	484
Enter Blocked Intersection	No	No	No	No	No	No	No
Lane Alignment	Left	R NA	Left	Left	R NA	L NA	R NA
Median Width(m)	7.0			9.0		10.5	
Link Offset(m)	0.0			0.0		0.0	
Crosswalk Width(m)	5.0			5.0		5.0	
Two way Left Turn Lane							
Headway Factor	1.09	1.09	1.09	1.09	1.09	1.09	1.09
Turning Speed (k/h)		14	24		14	24	14
Number of Detectors	2	1	1	2	1	1	1
Detector Template	Thru	Right	Left	Thru	Left	Left	Right
Leading Detector (m)	30.5	6.1	6.1	30.5	6.1	6.1	6.1
Trailing Detector (m)	0.0	0.0	0.0	0.0	0.0	0.0	0.0
Detector 1 Position(m)	0.0	0.0	0.0	0.0	0.0	0.0	0.0
Detector 1 Size(m)	1.8	6.1	6.1	1.8	6.1	6.1	6.1
Detector 1 Type	Cl+Ex	Cl+Ex	Cl+Ex	Cl+Ex	Cl+Ex	Cl+Ex	Cl+Ex
Detector 1 Channel							
Detector 1 Extend (s)	0.0	0.0	0.0	0.0	0.0	0.0	0.0
Detector 1 Queue (s)	0.0	0.0	0.0	0.0	0.0	0.0	0.0
Detector 1 Delay (s)	0.0	0.0	0.0	0.0	0.0	0.0	0.0
Detector 2 Position(m)	28.7			28.7			
Detector 2 Size(m)	1.8			1.8			
Detector 2 Type	Cl+Ex			Cl+Ex			
Detector 2 Channel							
Detector 2 Extend (s)	0.0			0.0			
Turn Type	NA	Perm	Prot	NA	Perm	Prot	Perm
Protected Phases	2		1	6		8	
Permitted Phases		2			8		8
Detector Phase	2	2	1	6	8	8	8



Lane Group	EBT	EBR	WBL	WBT	NBU	NBL	NBR
Switch Phase							
Minimum Initial (s)	10.0	10.0	5.0	10.0	5.0	5.0	5.0
Minimum Split (s)	36.4	36.4	16.0	24.7	30.4	30.4	30.4
Total Split (s)	55.0	55.0	25.0	80.0	40.0	40.0	40.0
Total Split (%)	45.8%	45.8%	20.8%	66.7%	33.3%	33.3%	33.3%
Maximum Green (s)	48.6	48.6	18.8	73.6	33.6	33.6	33.6
Yellow Time (s)	3.7	3.7	3.3	3.7	3.7	3.7	3.7
All-Red Time (s)	2.7	2.7	2.9	2.7	2.7	2.7	2.7
Lost Time Adjust (s)	0.0	0.0	0.0	0.0		0.0	0.0
Total Lost Time (s)	6.4	6.4	6.2	6.4		6.4	6.4
Lead/Lag	Lag	Lag	Lead				
Lead-Lag Optimize?	Yes	Yes	Yes				
Vehicle Extension (s)	3.0	3.0	3.0	3.0	3.0	3.0	3.0
Recall Mode	C-Max	C-Max	None	C-Max	None	None	None
Walk Time (s)	10.0	10.0			7.0	7.0	7.0
Flash Dont Walk (s)	20.0	20.0			17.0	17.0	17.0
Pedestrian Calls (#/hr)	10	10			5	5	5
Act Effct Green (s)	54.1	54.1	15.1	75.4		31.8	31.8
Actuated g/C Ratio	0.45	0.45	0.13	0.63		0.26	0.26
v/c Ratio	0.69	0.35	0.67	0.55		0.87	0.78
Control Delay	30.5	3.9	58.4	14.3		53.7	21.7
Queue Delay	0.3	0.0	0.0	0.0		0.0	0.0
Total Delay	30.9	3.9	58.4	14.3		53.7	21.7
LOS	C	A	E	B		D	C
Approach Delay	24.9			22.7		40.9	
Approach LOS	C			C		D	
Queue Length 50th (m)	90.9	0.0	27.7	68.9		76.4	30.1
Queue Length 95th (m)	119.8	14.9	39.0	85.5		97.6	70.5
Internal Link Dist (m)	145.1			247.7		324.5	
Turn Bay Length (m)		75.0	200.0				
Base Capacity (vph)	1424	793	480	1986		892	639
Starvation Cap Reductn	95	0	0	0		0	0
Spillback Cap Reductn	0	0	0	0		0	0
Storage Cap Reductn	0	0	0	0		0	0
Reduced v/c Ratio	0.74	0.35	0.54	0.55		0.82	0.76

Intersection Summary

Area Type: Other
 Cycle Length: 120
 Actuated Cycle Length: 120
 Offset: 43 (36%), Referenced to phase 2:EBT and 6:WBT, Start of Green
 Natural Cycle: 85
 Control Type: Actuated-Coordinated
 Maximum v/c Ratio: 0.87
 Intersection Signal Delay: 29.2
 Intersection LOS: C
 Intersection Capacity Utilization 74.4%
 ICU Level of Service D
 Analysis Period (min) 15

Splits and Phases: 3: Conroy & Walkley



4: Conroy & St. Laurent
AM Peak Hour

2510 St. Laurent Boulevard
2029 Background Traffic

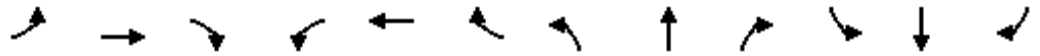

Lane Group	EBL	EBT	EBR	WBL	WBT	WBR	NBL	NBT	NBR	SBL	SBT	SBR
Lane Configurations												
Traffic Volume (vph)	6	65	81	63	43	25	192	1246	199	87	389	53
Future Volume (vph)	6	65	81	63	43	25	192	1246	199	87	389	53
Ideal Flow (vphpl)	1800	1800	1800	1800	1800	1800	1800	1800	1800	1800	1800	1800
Storage Length (m)	45.0		50.0	55.0		55.0	0.0		0.0	110.0		0.0
Storage Lanes	1		1	1		1	1		0	1		0
Taper Length (m)	40.0			40.0			10.0			25.0		
Lane Util. Factor	1.00	1.00	1.00	1.00	1.00	1.00	1.00	0.91	0.91	1.00	0.95	0.95
Ped Bike Factor	1.00		0.98	0.99		0.98	0.98	0.99		1.00	0.99	
Fr _t			0.850			0.850		0.979			0.982	
Fl _t Protected	0.950			0.950			0.950			0.950		
Satd. Flow (prot)	1353	1695	1427	1409	1589	1351	1642	4624	0	1674	3172	0
Fl _t Permitted	0.729			0.715			0.496			0.154		
Satd. Flow (perm)	1033	1695	1395	1050	1589	1328	844	4624	0	270	3172	0
Right Turn on Red			Yes			Yes			Yes			Yes
Satd. Flow (RTOR)			81			36		43			21	
Link Speed (k/h)		50			50			60			60	
Link Distance (m)		197.7			271.8			372.7			348.5	
Travel Time (s)		14.2			19.6			22.4			20.9	
Confl. Peds. (#/hr)	6		13	13		6	14		21	21		14
Confl. Bikes (#/hr)												25
Peak Hour Factor	1.00	1.00	1.00	1.00	1.00	1.00	1.00	1.00	1.00	1.00	1.00	1.00
Heavy Vehicles (%)	25%	5%	6%	20%	12%	12%	3%	2%	2%	1%	4%	3%
Adj. Flow (vph)	6	65	81	63	43	25	192	1246	199	87	389	53
Shared Lane Traffic (%)												
Lane Group Flow (vph)	6	65	81	63	43	25	192	1445	0	87	442	0
Enter Blocked Intersection	No	No	No	No	No	No	No	No	No	No	No	No
Lane Alignment	L NA	Left	R NA	L NA	Left	R NA	Left	Left	Right	L NA	Left	R NA
Median Width(m)		3.5			3.5			7.0			6.0	
Link Offset(m)		0.0			0.0			0.0			0.0	
Crosswalk Width(m)		5.0			5.0			5.0			5.0	
Two way Left Turn Lane												
Headway Factor	1.09	1.09	1.09	1.09	1.09	1.09	1.09	1.09	1.09	1.09	1.09	1.09
Turning Speed (k/h)	24		14	24		14	24		14	24		14
Number of Detectors	1	2	1	1	2	1	1	2		1	2	
Detector Template	Left	Thru	Right	Left	Thru	Right	Left	Thru		Left	Thru	
Leading Detector (m)	6.1	30.5	6.1	6.1	30.5	6.1	6.1	30.5		6.1	30.5	
Trailing Detector (m)	0.0	0.0	0.0	0.0	0.0	0.0	0.0	0.0		0.0	0.0	
Detector 1 Position(m)	0.0	0.0	0.0	0.0	0.0	0.0	0.0	0.0		0.0	0.0	
Detector 1 Size(m)	6.1	1.8	6.1	6.1	1.8	6.1	6.1	1.8		6.1	1.8	
Detector 1 Type	Cl+Ex	Cl+Ex	Cl+Ex	Cl+Ex	Cl+Ex	Cl+Ex	Cl+Ex	Cl+Ex		Cl+Ex	Cl+Ex	
Detector 1 Channel												
Detector 1 Extend (s)	0.0	0.0	0.0	0.0	0.0	0.0	0.0	0.0		0.0	0.0	
Detector 1 Queue (s)	0.0	0.0	0.0	0.0	0.0	0.0	0.0	0.0		0.0	0.0	
Detector 1 Delay (s)	0.0	0.0	0.0	0.0	0.0	0.0	0.0	0.0		0.0	0.0	
Detector 2 Position(m)		28.7			28.7			28.7			28.7	
Detector 2 Size(m)		1.8			1.8			1.8			1.8	
Detector 2 Type		Cl+Ex			Cl+Ex			Cl+Ex			Cl+Ex	
Detector 2 Channel												
Detector 2 Extend (s)		0.0			0.0			0.0			0.0	
Turn Type	Perm	NA	Perm	Perm	NA	Perm	Perm	NA		Perm	NA	
Protected Phases		4			8			2			6	
Permitted Phases	4		4	8		8	2			6		
Detector Phase	4	4	4	8	8	8	2	2		6	6	

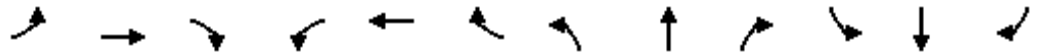

Lane Group	EBL	EBT	EBR	WBL	WBT	WBR	NBL	NBT	NBR	SBL	SBT	SBR
Switch Phase												
Minimum Initial (s)	10.0	10.0	10.0	10.0	10.0	10.0	10.0	10.0		10.0	10.0	
Minimum Split (s)	43.9	43.9	43.9	43.9	43.9	43.9	30.3	30.3		30.3	30.3	
Total Split (s)	44.0	44.0	44.0	44.0	44.0	44.0	56.0	56.0		56.0	56.0	
Total Split (%)	44.0%	44.0%	44.0%	44.0%	44.0%	44.0%	56.0%	56.0%		56.0%	56.0%	
Maximum Green (s)	37.1	37.1	37.1	37.1	37.1	37.1	49.7	49.7		49.7	49.7	
Yellow Time (s)	3.3	3.3	3.3	3.3	3.3	3.3	3.7	3.7		3.7	3.7	
All-Red Time (s)	3.6	3.6	3.6	3.6	3.6	3.6	2.6	2.6		2.6	2.6	
Lost Time Adjust (s)	0.0	0.0	0.0	0.0	0.0	0.0	0.0	0.0		0.0	0.0	
Total Lost Time (s)	6.9	6.9	6.9	6.9	6.9	6.9	6.3	6.3		6.3	6.3	
Lead/Lag												
Lead-Lag Optimize?												
Vehicle Extension (s)	3.0	3.0	3.0	3.0	3.0	3.0	3.0	3.0		3.0	3.0	
Recall Mode	None	None	None	None	None	None	C-Max	C-Max		C-Max	C-Max	
Walk Time (s)	7.0	7.0	7.0	7.0	7.0	7.0	7.0	7.0		7.0	7.0	
Flash Dont Walk (s)	30.0	30.0	30.0	30.0	30.0	30.0	17.0	17.0		17.0	17.0	
Pedestrian Calls (#/hr)	15	15	15	10	10	10	20	20		15	15	
Act Effct Green (s)	21.1	21.1	21.1	21.1	21.1	21.1	70.4	70.4		70.4	70.4	
Actuated g/C Ratio	0.21	0.21	0.21	0.21	0.21	0.21	0.70	0.70		0.70	0.70	
v/c Ratio	0.03	0.18	0.23	0.29	0.13	0.08	0.32	0.44		0.46	0.20	
Control Delay	23.2	28.4	6.8	31.8	27.4	5.2	13.1	10.6		26.2	8.7	
Queue Delay	0.0	0.0	0.0	0.0	0.0	0.0	0.0	0.0		0.0	0.0	
Total Delay	23.2	28.4	6.8	31.8	27.4	5.2	13.1	10.6		26.2	8.7	
LOS	C	C	A	C	C	A	B	B		C	A	
Approach Delay		16.7			25.3			10.9			11.6	
Approach LOS		B			C			B			B	
Queue Length 50th (m)	0.9	10.9	1.1	10.8	7.1	0.0	9.0	26.7		4.6	9.2	
Queue Length 95th (m)	m2.5	m16.1	8.9	16.0	11.5	3.5	39.2	77.6		#35.0	31.1	
Internal Link Dist (m)		173.7			247.8			348.7			324.5	
Turn Bay Length (m)	45.0		50.0	55.0		55.0				110.0		
Base Capacity (vph)	383	628	568	389	589	515	594	3266		190	2238	
Starvation Cap Reductn	0	0	0	0	0	0	0	0		0	0	
Spillback Cap Reductn	0	0	0	0	0	0	0	0		0	0	
Storage Cap Reductn	0	0	0	0	0	0	0	0		0	0	
Reduced v/c Ratio	0.02	0.10	0.14	0.16	0.07	0.05	0.32	0.44		0.46	0.20	

Intersection Summary

Area Type: Other
 Cycle Length: 100
 Actuated Cycle Length: 100
 Offset: 23 (23%), Referenced to phase 2:NBT and 6:SBT, Start of Green
 Natural Cycle: 90
 Control Type: Actuated-Coordinated
 Maximum v/c Ratio: 0.46
 Intersection Signal Delay: 12.2 Intersection LOS: B
 Intersection Capacity Utilization 71.2% ICU Level of Service C
 Analysis Period (min) 15
 # 95th percentile volume exceeds capacity, queue may be longer.
 Queue shown is maximum after two cycles.
 m Volume for 95th percentile queue is metered by upstream signal.

Splits and Phases: 4: Conroy & St. Laurent

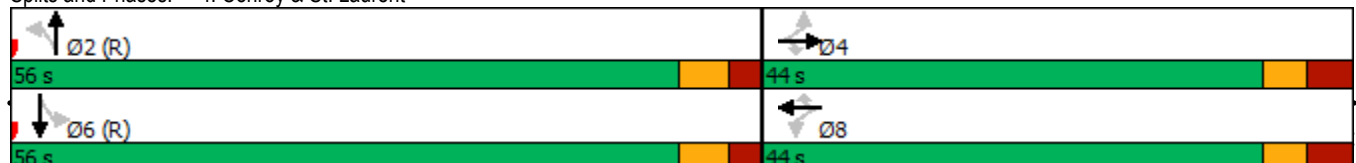



Lane Group	WBL	WBR	NBT	NBR	SBL	SBT
Lane Configurations						
Traffic Volume (vph)	75	40	71	22	69	176
Future Volume (vph)	75	40	71	22	69	176
Ideal Flow (vphpl)	1800	1800	1800	1800	1800	1800
Lane Util. Factor	1.00	1.00	1.00	1.00	1.00	1.00
Ped Bike Factor						
Frt	0.953		0.968			
Flt Protected	0.968					0.986
Satd. Flow (prot)	1563	0	1498	0	0	1678
Flt Permitted	0.968					0.986
Satd. Flow (perm)	1563	0	1498	0	0	1678
Link Speed (k/h)	50		50			50
Link Distance (m)	137.6		234.0			146.3
Travel Time (s)	9.9		16.8			10.5
Confl. Peds. (#/hr)				5	5	
Confl. Bikes (#/hr)		1				
Peak Hour Factor	1.00	1.00	1.00	1.00	1.00	1.00
Heavy Vehicles (%)	4%	7%	15%	15%	6%	4%
Adj. Flow (vph)	75	40	71	22	69	176
Shared Lane Traffic (%)						
Lane Group Flow (vph)	115	0	93	0	0	245
Enter Blocked Intersection	No	No	No	No	No	No
Lane Alignment	Left	Right	Left	Right	Left	Left
Median Width(m)	3.5		0.0			0.0
Link Offset(m)	0.0		0.0			0.0
Crosswalk Width(m)	2.0		10.0			10.0
Two way Left Turn Lane						
Headway Factor	1.09	1.09	1.09	1.09	1.09	1.09
Turning Speed (k/h)	24	14		14	24	
Sign Control	Stop		Free			Free

Intersection Summary

Area Type: Other

Control Type: Unsignalized

Intersection Capacity Utilization 34.1% ICU Level of Service A

Analysis Period (min) 15

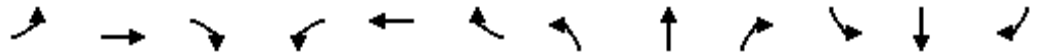

Lane Group	EBL	EBT	EBR	WBL	WBT	WBR	NBL	NBT	NBR	SBL	SBT	SBR
Lane Configurations												
Traffic Volume (vph)	27	1557	100	18	1626	70	162	5	70	92	104	50
Future Volume (vph)	27	1557	100	18	1626	70	162	5	70	92	104	50
Ideal Flow (vphpl)	1800	1800	1800	1800	1800	1800	1800	1800	1800	1800	1800	1800
Storage Length (m)	40.0		0.0	50.0		0.0	35.0		0.0	30.0		0.0
Storage Lanes	1		0	1		0	1		0	1		0
Taper Length (m)	25.0			30.0			25.0			30.0		
Lane Util. Factor	1.00	0.95	0.95	1.00	0.95	0.95	1.00	1.00	1.00	1.00	1.00	1.00
Ped Bike Factor		1.00			1.00		1.00				1.00	
Frt		0.991			0.994			0.860			0.951	
Flt Protected	0.950			0.950			0.950			0.950		
Satd. Flow (prot)	1674	3246	0	1674	3294	0	1674	1502	0	1674	1652	0
Flt Permitted	0.092			0.099			0.594			0.708		
Satd. Flow (perm)	162	3246	0	174	3294	0	1045	1502	0	1248	1652	0
Right Turn on Red			Yes			Yes			Yes			Yes
Satd. Flow (RTOR)		11			7			35			22	
Link Speed (k/h)		50			50			50			50	
Link Distance (m)		402.0			171.1			100.3			281.0	
Travel Time (s)		28.9			12.3			7.2			20.2	
Confl. Peds. (#/hr)	1		10	10		1	2					2
Confl. Bikes (#/hr)			1									
Peak Hour Factor	1.00	1.00	1.00	1.00	1.00	1.00	1.00	1.00	1.00	1.00	1.00	1.00
Heavy Vehicles (%)	1%	3%	3%	1%	2%	1%	1%	1%	2%	1%	1%	4%
Adj. Flow (vph)	27	1557	100	18	1626	70	162	5	70	92	104	50
Shared Lane Traffic (%)												
Lane Group Flow (vph)	27	1657	0	18	1696	0	162	75	0	92	154	0
Enter Blocked Intersection	No	No	No	No	No	No	No	No	No	No	No	No
Lane Alignment	L NA	Left	R NA	Left	Left	Right	L NA	Left	R NA	L NA	Left	R NA
Median Width(m)		5.0			5.0			3.5			3.5	
Link Offset(m)		0.0			0.0			0.0			0.0	
Crosswalk Width(m)		5.0			5.0			5.0			5.0	
Two way Left Turn Lane												
Headway Factor	1.09	1.09	1.09	1.09	1.09	1.09	1.09	1.09	1.09	1.09	1.09	1.09
Turning Speed (k/h)	24		14	24		14	24		14	24		14
Number of Detectors	1	2		1	2		1	2		1	2	
Detector Template	Left	Thru		Left	Thru		Left	Thru		Left	Thru	
Leading Detector (m)	6.1	30.5		6.1	30.5		6.1	30.5		6.1	30.5	
Trailing Detector (m)	0.0	0.0		0.0	0.0		0.0	0.0		0.0	0.0	
Detector 1 Position(m)	0.0	0.0		0.0	0.0		0.0	0.0		0.0	0.0	
Detector 1 Size(m)	6.1	1.8		6.1	1.8		6.1	1.8		6.1	1.8	
Detector 1 Type	Cl+Ex	Cl+Ex		Cl+Ex	Cl+Ex		Cl+Ex	Cl+Ex		Cl+Ex	Cl+Ex	
Detector 1 Channel												
Detector 1 Extend (s)	0.0	0.0		0.0	0.0		0.0	0.0		0.0	0.0	
Detector 1 Queue (s)	0.0	0.0		0.0	0.0		0.0	0.0		0.0	0.0	
Detector 1 Delay (s)	0.0	0.0		0.0	0.0		0.0	0.0		0.0	0.0	
Detector 2 Position(m)		28.7			28.7			28.7			28.7	
Detector 2 Size(m)		1.8			1.8			1.8			1.8	
Detector 2 Type		Cl+Ex			Cl+Ex			Cl+Ex			Cl+Ex	
Detector 2 Channel												
Detector 2 Extend (s)		0.0			0.0			0.0			0.0	
Turn Type	Perm	NA		Perm	NA		Perm	NA		Perm	NA	
Protected Phases		2			6			8			4	
Permitted Phases	2			6			8			4		
Detector Phase	2	2		6	6		8	8		4	4	



Lane Group	EBT	EBR	WBL	WBT	NBL	NBR
Lane Configurations	↑↑	↑	↓	↑↑	↓	↑
Traffic Volume (vph)	1741	64	36	1650	49	41
Future Volume (vph)	1741	64	36	1650	49	41
Ideal Flow (vphpl)	1800	1800	1800	1800	1800	1800
Storage Length (m)		20.0	65.0		30.0	0.0
Storage Lanes		1	1		1	1
Taper Length (m)			25.0		30.0	
Lane Util. Factor	0.95	1.00	1.00	0.95	1.00	1.00
Ped Bike Factor		0.97	1.00			0.99
Fr _t		0.850				0.850
Fl _t Protected			0.950		0.950	
Satd. Flow (prot)	3252	1483	1642	3316	1658	1483
Fl _t Permitted			0.110		0.950	
Satd. Flow (perm)	3252	1441	190	3316	1658	1463
Right Turn on Red		Yes				Yes
Satd. Flow (RTOR)		28				34
Link Speed (k/h)	50			50	50	
Link Distance (m)	171.1			169.1	128.6	
Travel Time (s)	12.3			12.2	9.3	
Confl. Peds. (#/hr)		5	5			1
Peak Hour Factor	1.00	1.00	1.00	1.00	1.00	1.00
Heavy Vehicles (%)	4%	2%	3%	2%	2%	2%
Adj. Flow (vph)	1741	64	36	1650	49	41
Shared Lane Traffic (%)						
Lane Group Flow (vph)	1741	64	36	1650	49	41
Enter Blocked Intersection	No	No	No	No	No	No
Lane Alignment	Left	Right	L NA	Left	L NA	R NA
Median Width(m)	3.5			5.0	3.5	
Link Offset(m)	0.0			0.0	0.0	
Crosswalk Width(m)	5.0			5.0	5.0	
Two way Left Turn Lane						
Headway Factor	1.09	1.09	1.09	1.09	1.09	1.09
Turning Speed (k/h)		14	24		24	14
Number of Detectors	2	1	1	2	1	1
Detector Template	Thru	Right	Left	Thru	Left	Right
Leading Detector (m)	30.5	6.1	6.1	30.5	6.1	6.1
Trailing Detector (m)	0.0	0.0	0.0	0.0	0.0	0.0
Detector 1 Position(m)	0.0	0.0	0.0	0.0	0.0	0.0
Detector 1 Size(m)	1.8	6.1	6.1	1.8	6.1	6.1
Detector 1 Type	CI+Ex	CI+Ex	CI+Ex	CI+Ex	CI+Ex	CI+Ex
Detector 1 Channel						
Detector 1 Extend (s)	0.0	0.0	0.0	0.0	0.0	0.0
Detector 1 Queue (s)	0.0	0.0	0.0	0.0	0.0	0.0
Detector 1 Delay (s)	0.0	0.0	0.0	0.0	0.0	0.0
Detector 2 Position(m)	28.7			28.7		
Detector 2 Size(m)	1.8			1.8		
Detector 2 Type	CI+Ex			CI+Ex		
Detector 2 Channel						
Detector 2 Extend (s)	0.0			0.0		
Turn Type	NA	Perm	Perm	NA	Prot	Perm
Protected Phases	2			6	8	
Permitted Phases		2	6			8
Detector Phase	2	2	6	6	8	8
Switch Phase						

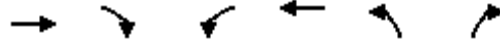

Lane Group	EBT	EBR	WBL	WBT	NBL	NBR
Minimum Initial (s)	10.0	10.0	10.0	10.0	5.0	5.0
Minimum Split (s)	37.0	37.0	37.0	37.0	29.0	29.0
Total Split (s)	81.0	81.0	81.0	81.0	29.0	29.0
Total Split (%)	73.6%	73.6%	73.6%	73.6%	26.4%	26.4%
Maximum Green (s)	75.0	75.0	75.0	75.0	23.0	23.0
Yellow Time (s)	3.3	3.3	3.3	3.3	3.3	3.3
All-Red Time (s)	2.7	2.7	2.7	2.7	2.7	2.7
Lost Time Adjust (s)	0.0	0.0	0.0	0.0	0.0	0.0
Total Lost Time (s)	6.0	6.0	6.0	6.0	6.0	6.0
Lead/Lag						
Lead-Lag Optimize?						
Vehicle Extension (s)	3.0	3.0	3.0	3.0	3.0	3.0
Recall Mode	C-Max	C-Max	C-Max	C-Max	None	None
Walk Time (s)	18.0	18.0			7.0	7.0
Flash Dont Walk (s)	13.0	13.0			16.0	16.0
Pedestrian Calls (#/hr)	5	5			5	5
Act Effct Green (s)	90.6	90.6	90.6	90.6	10.9	10.9
Actuated g/C Ratio	0.82	0.82	0.82	0.82	0.10	0.10
v/c Ratio	0.65	0.05	0.23	0.60	0.30	0.23
Control Delay	2.2	0.7	9.3	7.5	48.0	19.5
Queue Delay	0.1	0.0	0.0	0.1	0.0	0.0
Total Delay	2.3	0.7	9.3	7.7	48.0	19.5
LOS	A	A	A	A	D	B
Approach Delay	2.3			7.7	35.0	
Approach LOS	A			A	D	
Queue Length 50th (m)	16.1	0.1	0.6	74.6	9.4	1.3
Queue Length 95th (m)	22.3	m0.6	m7.6	141.3	17.5	9.4
Internal Link Dist (m)	147.1			145.1	104.6	
Turn Bay Length (m)		20.0	65.0		30.0	
Base Capacity (vph)	2679	1192	156	2731	346	332
Starvation Cap Reductn	74	0	0	265	0	0
Spillback Cap Reductn	187	0	0	0	0	1
Storage Cap Reductn	0	0	0	0	0	0
Reduced v/c Ratio	0.70	0.05	0.23	0.67	0.14	0.12

Intersection Summary

Area Type: Other
 Cycle Length: 110
 Actuated Cycle Length: 110
 Offset: 25 (23%), Referenced to phase 2:EBT and 6:WBTL, Start of Green
 Natural Cycle: 80
 Control Type: Actuated-Coordinated
 Maximum v/c Ratio: 0.65
 Intersection Signal Delay: 5.7
 Intersection LOS: A
 Intersection Capacity Utilization 65.5%
 ICU Level of Service C
 Analysis Period (min) 15
 m Volume for 95th percentile queue is metered by upstream signal.

Splits and Phases: 2: 160m W of Conroy & Walkley





Lane Group	EBT	EBR	WBL	WBT	NBU	NBL	NBR
Lane Configurations	↑↑	↑	↑↑	↑↑		↑↑	↑
Traffic Volume (vph)	1311	474	537	1171	42	484	328
Future Volume (vph)	1311	474	537	1171	42	484	328
Ideal Flow (vphpl)	1800	1800	1800	1800	1800	1800	1800
Storage Length (m)		75.0	200.0			0.0	0.0
Storage Lanes		1	2			2	1
Taper Length (m)			50.0			10.0	
Lane Util. Factor	0.95	1.00	0.97	0.95	0.95	0.97	1.00
Ped Bike Factor		0.96	0.99				0.97
Fr _t		0.850					0.850
Fl _t Protected			0.950			0.950	
Satd. Flow (prot)	3221	1483	3185	3349	0	3248	1469
Fl _t Permitted			0.950			0.950	
Satd. Flow (perm)	3221	1430	3164	3349	0	3248	1418
Right Turn on Red		Yes					Yes
Satd. Flow (RTOR)		443					328
Link Speed (k/h)	50			50		60	
Link Distance (m)	169.1			271.7		348.5	
Travel Time (s)	12.2			19.6		20.9	
Confl. Peds. (#/hr)		22	22				16
Confl. Bikes (#/hr)		1					1
Peak Hour Factor	1.00	1.00	1.00	1.00	1.00	1.00	1.00
Heavy Vehicles (%)	5%	2%	3%	1%	1%	1%	3%
Adj. Flow (vph)	1311	474	537	1171	42	484	328
Shared Lane Traffic (%)							
Lane Group Flow (vph)	1311	474	537	1171	0	526	328
Enter Blocked Intersection	No	No	No	No	No	No	No
Lane Alignment	Left	R NA	Left	Left	R NA	L NA	R NA
Median Width(m)	7.0			9.0		10.5	
Link Offset(m)	0.0			0.0		0.0	
Crosswalk Width(m)	5.0			5.0		5.0	
Two way Left Turn Lane							
Headway Factor	1.09	1.09	1.09	1.09	1.09	1.09	1.09
Turning Speed (k/h)		14	24		14	24	14
Number of Detectors	2	1	1	2	1	1	1
Detector Template	Thru	Right	Left	Thru	Left	Left	Right
Leading Detector (m)	30.5	6.1	6.1	30.5	6.1	6.1	6.1
Trailing Detector (m)	0.0	0.0	0.0	0.0	0.0	0.0	0.0
Detector 1 Position(m)	0.0	0.0	0.0	0.0	0.0	0.0	0.0
Detector 1 Size(m)	1.8	6.1	6.1	1.8	6.1	6.1	6.1
Detector 1 Type	Cl+Ex	Cl+Ex	Cl+Ex	Cl+Ex	Cl+Ex	Cl+Ex	Cl+Ex
Detector 1 Channel							
Detector 1 Extend (s)	0.0	0.0	0.0	0.0	0.0	0.0	0.0
Detector 1 Queue (s)	0.0	0.0	0.0	0.0	0.0	0.0	0.0
Detector 1 Delay (s)	0.0	0.0	0.0	0.0	0.0	0.0	0.0
Detector 2 Position(m)	28.7			28.7			
Detector 2 Size(m)	1.8			1.8			
Detector 2 Type	Cl+Ex			Cl+Ex			
Detector 2 Channel							
Detector 2 Extend (s)	0.0			0.0			
Turn Type	NA	Perm	Prot	NA	Perm	Prot	Perm
Protected Phases	2		1	6		8	
Permitted Phases		2			8		8
Detector Phase	2	2	1	6	8	8	8



Lane Group	EBT	EBR	WBL	WBT	NBU	NBL	NBR
Switch Phase							
Minimum Initial (s)	10.0	10.0	5.0	10.0	5.0	5.0	5.0
Minimum Split (s)	36.4	36.4	16.0	24.7	30.4	30.4	30.4
Total Split (s)	51.0	51.0	28.0	79.0	31.0	31.0	31.0
Total Split (%)	46.4%	46.4%	25.5%	71.8%	28.2%	28.2%	28.2%
Maximum Green (s)	44.6	44.6	21.8	72.6	24.6	24.6	24.6
Yellow Time (s)	3.7	3.7	3.3	3.7	3.7	3.7	3.7
All-Red Time (s)	2.7	2.7	2.9	2.7	2.7	2.7	2.7
Lost Time Adjust (s)	0.0	0.0	0.0	0.0		0.0	0.0
Total Lost Time (s)	6.4	6.4	6.2	6.4		6.4	6.4
Lead/Lag	Lag	Lag	Lead				
Lead-Lag Optimize?	Yes	Yes	Yes				
Vehicle Extension (s)	3.0	3.0	3.0	3.0	3.0	3.0	3.0
Recall Mode	C-Max	C-Max	None	C-Max	None	None	None
Walk Time (s)	10.0	10.0			7.0	7.0	7.0
Flash Dont Walk (s)	20.0	20.0			17.0	17.0	17.0
Pedestrian Calls (#/hr)	20	20			15	15	15
Act Effct Green (s)	47.3	47.3	21.3	74.8		22.4	22.4
Actuated g/C Ratio	0.43	0.43	0.19	0.68		0.20	0.20
v/c Ratio	0.95	0.55	0.87	0.51		0.80	0.60
Control Delay	41.5	7.7	58.8	9.9		51.2	8.9
Queue Delay	0.0	0.2	0.0	0.0		0.0	0.0
Total Delay	41.5	7.9	58.8	10.0		51.2	8.9
LOS	D	A	E	A		D	A
Approach Delay	32.6			25.3		35.0	
Approach LOS	C			C		C	
Queue Length 50th (m)	~104.1	0.3	52.6	56.2		50.4	0.0
Queue Length 95th (m)	#179.1	39.9	#77.4	72.2		67.0	21.5
Internal Link Dist (m)	145.1			247.7		324.5	
Turn Bay Length (m)		75.0	200.0				
Base Capacity (vph)	1385	867	636	2278		726	571
Starvation Cap Reductn	0	57	0	0		0	0
Spillback Cap Reductn	0	0	0	101		0	0
Storage Cap Reductn	0	0	0	0		0	0
Reduced v/c Ratio	0.95	0.59	0.84	0.54		0.72	0.57

Intersection Summary

Area Type: Other
 Cycle Length: 110
 Actuated Cycle Length: 110
 Offset: 20 (18%), Referenced to phase 2:EBT and 6:WBT, Start of Green
 Natural Cycle: 95
 Control Type: Actuated-Coordinated
 Maximum v/c Ratio: 0.95
 Intersection Signal Delay: 30.2 Intersection LOS: C
 Intersection Capacity Utilization 87.8% ICU Level of Service E
 Analysis Period (min) 15
 ~ Volume exceeds capacity, queue is theoretically infinite.
 Queue shown is maximum after two cycles.
 # 95th percentile volume exceeds capacity, queue may be longer.
 Queue shown is maximum after two cycles.

Splits and Phases: 3: Conroy & Walkley

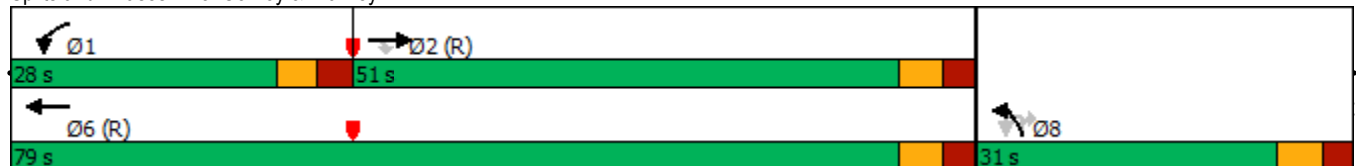

4: Conroy & St. Laurent
PM Peak Hour

2510 St. Laurent Boulevard
2029 Background Traffic

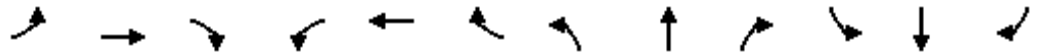

Lane Group	EBL	EBT	EBR	WBL	WBT	WBR	NBL	NBT	NBR	SBL	SBT	SBR
Lane Configurations												
Traffic Volume (vph)	41	77	316	232	34	102	40	595	81	37	1111	13
Future Volume (vph)	41	77	316	232	34	102	40	595	81	37	1111	13
Ideal Flow (vphpl)	1800	1800	1800	1800	1800	1800	1800	1800	1800	1800	1800	1800
Storage Length (m)	45.0		50.0	55.0		55.0	0.0		0.0	110.0		0.0
Storage Lanes	1		1	1		1	1		0	1		0
Taper Length (m)	40.0			40.0			10.0			25.0		
Lane Util. Factor	1.00	1.00	1.00	1.00	1.00	1.00	1.00	0.91	0.91	1.00	0.95	0.95
Ped Bike Factor	1.00		0.98	1.00		0.99		0.99		0.99	1.00	
Fr			0.850			0.850		0.982			0.998	
Flt Protected	0.950			0.950			0.950			0.950		
Satd. Flow (prot)	1674	1728	1483	1642	1618	1483	1642	4619	0	1537	3303	0
Flt Permitted	0.735			0.555			0.155			0.371		
Satd. Flow (perm)	1293	1728	1461	957	1618	1463	268	4619	0	595	3303	0
Right Turn on Red			Yes			Yes			Yes			Yes
Satd. Flow (RTOR)			121			78		27			1	
Link Speed (k/h)		50			50			60			60	
Link Distance (m)		197.7			271.8			372.7			348.5	
Travel Time (s)		14.2			19.6			22.4			20.9	
Confl. Peds. (#/hr)	2		4	4		2	8		12	12		8
Confl. Bikes (#/hr)									4			11
Peak Hour Factor	1.00	1.00	1.00	1.00	1.00	1.00	1.00	1.00	1.00	1.00	1.00	1.00
Heavy Vehicles (%)	1%	3%	2%	3%	10%	2%	3%	2%	8%	10%	2%	12%
Adj. Flow (vph)	41	77	316	232	34	102	40	595	81	37	1111	13
Shared Lane Traffic (%)												
Lane Group Flow (vph)	41	77	316	232	34	102	40	676	0	37	1124	0
Enter Blocked Intersection	No	No	No	No	No	No	No	No	No	No	No	No
Lane Alignment	L NA	Left	R NA	L NA	Left	R NA	Left	Left	Right	L NA	Left	R NA
Median Width(m)		3.5			3.5			7.0			6.0	
Link Offset(m)		0.0			0.0			0.0			0.0	
Crosswalk Width(m)		5.0			5.0			5.0			5.0	
Two way Left Turn Lane												
Headway Factor	1.09	1.09	1.09	1.09	1.09	1.09	1.09	1.09	1.09	1.09	1.09	1.09
Turning Speed (k/h)	24		14	24		14	24		14	24		14
Number of Detectors	1	2	1	1	2	1	1	2		1	2	
Detector Template	Left	Thru	Right	Left	Thru	Right	Left	Thru		Left	Thru	
Leading Detector (m)	6.1	30.5	6.1	6.1	30.5	6.1	6.1	30.5		6.1	30.5	
Trailing Detector (m)	0.0	0.0	0.0	0.0	0.0	0.0	0.0	0.0		0.0	0.0	
Detector 1 Position(m)	0.0	0.0	0.0	0.0	0.0	0.0	0.0	0.0		0.0	0.0	
Detector 1 Size(m)	6.1	1.8	6.1	6.1	1.8	6.1	6.1	1.8		6.1	1.8	
Detector 1 Type	Cl+Ex	Cl+Ex	Cl+Ex	Cl+Ex	Cl+Ex	Cl+Ex	Cl+Ex	Cl+Ex		Cl+Ex	Cl+Ex	
Detector 1 Channel												
Detector 1 Extend (s)	0.0	0.0	0.0	0.0	0.0	0.0	0.0	0.0		0.0	0.0	
Detector 1 Queue (s)	0.0	0.0	0.0	0.0	0.0	0.0	0.0	0.0		0.0	0.0	
Detector 1 Delay (s)	0.0	0.0	0.0	0.0	0.0	0.0	0.0	0.0		0.0	0.0	
Detector 2 Position(m)		28.7			28.7			28.7			28.7	
Detector 2 Size(m)		1.8			1.8			1.8			1.8	
Detector 2 Type		Cl+Ex			Cl+Ex			Cl+Ex			Cl+Ex	
Detector 2 Channel												
Detector 2 Extend (s)		0.0			0.0			0.0			0.0	
Turn Type	Perm	NA	Perm	pm+pt	NA	Perm	Perm	NA		Perm	NA	
Protected Phases		4		3	8			2			6	
Permitted Phases	4		4	8		8	2			6		
Detector Phase	4	4	4	3	8	8	2	2		6	6	

4: Conroy & St. Laurent
PM Peak Hour

2510 St. Laurent Boulevard
2029 Background Traffic

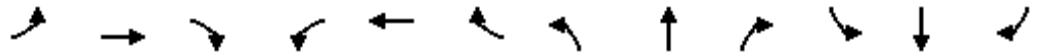

Lane Group	EBL	EBT	EBR	WBL	WBT	WBR	NBL	NBT	NBR	SBL	SBT	SBR
Switch Phase												
Minimum Initial (s)	10.0	10.0	10.0	5.0	10.0	10.0	10.0	10.0		10.0	10.0	
Minimum Split (s)	43.9	43.9	43.9	11.3	43.9	43.9	30.3	30.3		30.3	30.3	
Total Split (s)	44.0	44.0	44.0	15.0	59.0	59.0	36.0	36.0		36.0	36.0	
Total Split (%)	46.3%	46.3%	46.3%	15.8%	62.1%	62.1%	37.9%	37.9%		37.9%	37.9%	
Maximum Green (s)	37.1	37.1	37.1	9.3	52.1	52.1	29.7	29.7		29.7	29.7	
Yellow Time (s)	3.3	3.3	3.3	3.3	3.3	3.3	3.7	3.7		3.7	3.7	
All-Red Time (s)	3.6	3.6	3.6	2.4	3.6	3.6	2.6	2.6		2.6	2.6	
Lost Time Adjust (s)	0.0	0.0	0.0	0.0	0.0	0.0	0.0	0.0		0.0	0.0	
Total Lost Time (s)	6.9	6.9	6.9	5.7	6.9	6.9	6.3	6.3		6.3	6.3	
Lead/Lag	Lag	Lag	Lag	Lead								
Lead-Lag Optimize?	Yes	Yes	Yes	Yes								
Vehicle Extension (s)	3.0	3.0	3.0	3.0	3.0	3.0	3.0	3.0		3.0	3.0	
Recall Mode	None	None	None	None	None	None	C-Max	C-Max		C-Max	C-Max	
Walk Time (s)	7.0	7.0	7.0		7.0	7.0	7.0	7.0		7.0	7.0	
Flash Dont Walk (s)	30.0	30.0	30.0		30.0	30.0	17.0	17.0		17.0	17.0	
Pedestrian Calls (#/hr)	5	5	5		5	5	10	10		10	10	
Act Effct Green (s)	20.9	20.9	20.9	37.1	35.9	35.9	45.9	45.9		45.9	45.9	
Actuated g/C Ratio	0.22	0.22	0.22	0.39	0.38	0.38	0.48	0.48		0.48	0.48	
v/c Ratio	0.14	0.20	0.76	0.53	0.06	0.17	0.31	0.30		0.13	0.70	
Control Delay	26.5	27.8	31.6	23.5	15.3	5.6	29.7	16.5		20.1	25.0	
Queue Delay	0.0	0.0	0.0	0.0	0.0	0.0	0.0	0.0		0.0	0.0	
Total Delay	26.5	27.8	31.6	23.5	15.3	5.6	29.7	16.5		20.1	25.0	
LOS	C	C	C	C	B	A	C	B		C	C	
Approach Delay		30.5			17.8			17.3			24.9	
Approach LOS		C			B			B			C	
Queue Length 50th (m)	5.8	11.0	32.2	28.4	3.7	2.6	3.8	22.1		3.2	71.5	
Queue Length 95th (m)	10.4	16.5	45.3	30.7	6.4	8.2	#18.4	42.1		12.1	#149.8	
Internal Link Dist (m)		173.7			247.8			348.7			324.5	
Turn Bay Length (m)	45.0		50.0	55.0		55.0				110.0		
Base Capacity (vph)	504	674	644	440	887	837	129	2244		287	1595	
Starvation Cap Reductn	0	0	0	0	0	0	0	0		0	0	
Spillback Cap Reductn	0	0	0	0	0	0	0	0		0	0	
Storage Cap Reductn	0	0	0	0	0	0	0	0		0	0	
Reduced v/c Ratio	0.08	0.11	0.49	0.53	0.04	0.12	0.31	0.30		0.13	0.70	

Intersection Summary

Area Type: Other
 Cycle Length: 95
 Actuated Cycle Length: 95
 Offset: 2 (2%), Referenced to phase 2:NBT and 6:SBTL, Start of Green
 Natural Cycle: 90
 Control Type: Actuated-Coordinated
 Maximum v/c Ratio: 0.76
 Intersection Signal Delay: 22.8 Intersection LOS: C
 Intersection Capacity Utilization 84.5% ICU Level of Service E
 Analysis Period (min) 15
 # 95th percentile volume exceeds capacity, queue may be longer.
 Queue shown is maximum after two cycles.

Splits and Phases: 4: Conroy & St. Laurent

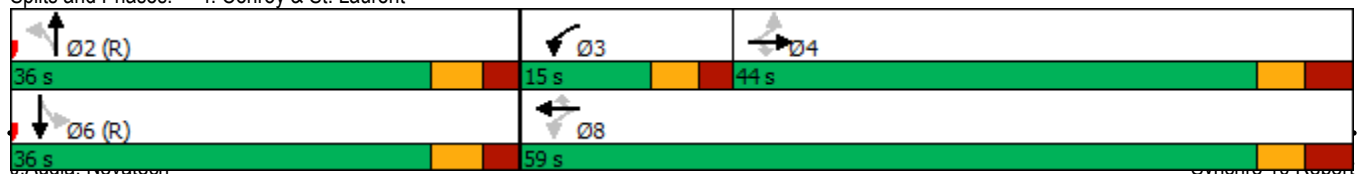



Lane Group	WBL	WBR	NBT	NBR	SBL	SBT
Lane Configurations						
Traffic Volume (vph)	23	56	107	76	151	51
Future Volume (vph)	23	56	107	76	151	51
Ideal Flow (vphpl)	1800	1800	1800	1800	1800	1800
Lane Util. Factor	1.00	1.00	1.00	1.00	1.00	1.00
Ped Bike Factor						
Frt	0.904		0.944			
Flt Protected	0.986					0.964
Satd. Flow (prot)	1481	0	1641	0	0	1588
Flt Permitted	0.986					0.964
Satd. Flow (perm)	1481	0	1641	0	0	1588
Link Speed (k/h)	50		50			50
Link Distance (m)	137.6		234.0			146.3
Travel Time (s)	9.9		16.8			10.5
Confl. Peds. (#/hr)				2	2	
Confl. Bikes (#/hr)		1		4		
Peak Hour Factor	1.00	1.00	1.00	1.00	1.00	1.00
Heavy Vehicles (%)	5%	8%	2%	3%	4%	20%
Adj. Flow (vph)	23	56	107	76	151	51
Shared Lane Traffic (%)						
Lane Group Flow (vph)	79	0	183	0	0	202
Enter Blocked Intersection	No	No	No	No	No	No
Lane Alignment	Left	Right	Left	Right	Left	Left
Median Width(m)	3.5		0.0			0.0
Link Offset(m)	0.0		0.0			0.0
Crosswalk Width(m)	2.0		10.0			10.0
Two way Left Turn Lane						
Headway Factor	1.09	1.09	1.09	1.09	1.09	1.09
Turning Speed (k/h)	24	14		14	24	
Sign Control	Stop		Free			Free

Intersection Summary

Area Type: Other

Control Type: Unsignalized

Intersection Capacity Utilization 37.7%

ICU Level of Service A

Analysis Period (min) 15

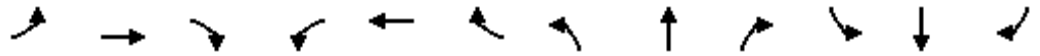

Lane Group	EBL	EBT	EBR	WBL	WBT	WBR	NBL	NBT	NBR	SBL	SBT	SBR
Lane Configurations												
Traffic Volume (vph)	27	1557	100	18	1626	70	162	5	70	92	104	50
Future Volume (vph)	27	1557	100	18	1626	70	162	5	70	92	104	50
Ideal Flow (vphpl)	1800	1800	1800	1800	1800	1800	1800	1800	1800	1800	1800	1800
Storage Length (m)	40.0		0.0	50.0		0.0	35.0		0.0	30.0		0.0
Storage Lanes	1		0	1		0	1		0	1		0
Taper Length (m)	25.0			30.0			25.0			30.0		
Lane Util. Factor	1.00	0.95	0.95	1.00	0.95	0.95	1.00	1.00	1.00	1.00	1.00	1.00
Ped Bike Factor		1.00			1.00		1.00				1.00	
Frt		0.991			0.994			0.860			0.951	
Flt Protected	0.950			0.950			0.950			0.950		
Satd. Flow (prot)	1674	3246	0	1674	3294	0	1674	1502	0	1674	1652	0
Flt Permitted	0.092			0.099			0.594			0.708		
Satd. Flow (perm)	162	3246	0	174	3294	0	1045	1502	0	1248	1652	0
Right Turn on Red			Yes			Yes			Yes			Yes
Satd. Flow (RTOR)		11			7			35			22	
Link Speed (k/h)		50			50			50			50	
Link Distance (m)		402.0			171.1			100.3			281.0	
Travel Time (s)		28.9			12.3			7.2			20.2	
Confl. Peds. (#/hr)	1		10	10		1	2					2
Confl. Bikes (#/hr)			1									
Peak Hour Factor	1.00	1.00	1.00	1.00	1.00	1.00	1.00	1.00	1.00	1.00	1.00	1.00
Heavy Vehicles (%)	1%	3%	3%	1%	2%	1%	1%	1%	2%	1%	1%	4%
Adj. Flow (vph)	27	1557	100	18	1626	70	162	5	70	92	104	50
Shared Lane Traffic (%)												
Lane Group Flow (vph)	27	1657	0	18	1696	0	162	75	0	92	154	0
Enter Blocked Intersection	No	No	No	No	No	No	No	No	No	No	No	No
Lane Alignment	L NA	Left	R NA	Left	Left	Right	L NA	Left	R NA	L NA	Left	R NA
Median Width(m)		5.0			5.0			3.5			3.5	
Link Offset(m)		0.0			0.0			0.0			0.0	
Crosswalk Width(m)		5.0			5.0			5.0			5.0	
Two way Left Turn Lane												
Headway Factor	1.09	1.09	1.09	1.09	1.09	1.09	1.09	1.09	1.09	1.09	1.09	1.09
Turning Speed (k/h)	24		14	24		14	24		14	24		14
Number of Detectors	1	2		1	2		1	2		1	2	
Detector Template	Left	Thru		Left	Thru		Left	Thru		Left	Thru	
Leading Detector (m)	6.1	30.5		6.1	30.5		6.1	30.5		6.1	30.5	
Trailing Detector (m)	0.0	0.0		0.0	0.0		0.0	0.0		0.0	0.0	
Detector 1 Position(m)	0.0	0.0		0.0	0.0		0.0	0.0		0.0	0.0	
Detector 1 Size(m)	6.1	1.8		6.1	1.8		6.1	1.8		6.1	1.8	
Detector 1 Type	Cl+Ex	Cl+Ex		Cl+Ex	Cl+Ex		Cl+Ex	Cl+Ex		Cl+Ex	Cl+Ex	
Detector 1 Channel												
Detector 1 Extend (s)	0.0	0.0		0.0	0.0		0.0	0.0		0.0	0.0	
Detector 1 Queue (s)	0.0	0.0		0.0	0.0		0.0	0.0		0.0	0.0	
Detector 1 Delay (s)	0.0	0.0		0.0	0.0		0.0	0.0		0.0	0.0	
Detector 2 Position(m)		28.7			28.7			28.7			28.7	
Detector 2 Size(m)		1.8			1.8			1.8			1.8	
Detector 2 Type		Cl+Ex			Cl+Ex			Cl+Ex			Cl+Ex	
Detector 2 Channel												
Detector 2 Extend (s)		0.0			0.0			0.0			0.0	
Turn Type	Perm	NA		Perm	NA		Perm	NA		Perm	NA	
Protected Phases		2			6			8			4	
Permitted Phases	2			6			8			4		
Detector Phase	2	2		6	6		8	8		4	4	

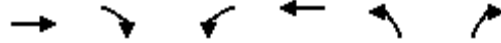

Lane Group	EBT	EBR	WBL	WBT	NBL	NBR
Lane Configurations	↑↑	↗	↖	↑↑	↖	↗
Traffic Volume (vph)	1741	64	36	1650	49	41
Future Volume (vph)	1741	64	36	1650	49	41
Ideal Flow (vphpl)	1800	1800	1800	1800	1800	1800
Storage Length (m)		20.0	65.0		30.0	0.0
Storage Lanes		1	1		1	1
Taper Length (m)			25.0		30.0	
Lane Util. Factor	0.95	1.00	1.00	0.95	1.00	1.00
Ped Bike Factor		0.97	1.00			0.99
Fr _t		0.850				0.850
Fl _t Protected			0.950		0.950	
Satd. Flow (prot)	3252	1483	1642	3316	1658	1483
Fl _t Permitted			0.110		0.950	
Satd. Flow (perm)	3252	1441	190	3316	1658	1463
Right Turn on Red		Yes				Yes
Satd. Flow (RTOR)		28				34
Link Speed (k/h)	50			50	50	
Link Distance (m)	171.1			169.1	128.6	
Travel Time (s)	12.3			12.2	9.3	
Confl. Peds. (#/hr)		5	5			1
Peak Hour Factor	1.00	1.00	1.00	1.00	1.00	1.00
Heavy Vehicles (%)	4%	2%	3%	2%	2%	2%
Adj. Flow (vph)	1741	64	36	1650	49	41
Shared Lane Traffic (%)						
Lane Group Flow (vph)	1741	64	36	1650	49	41
Enter Blocked Intersection	No	No	No	No	No	No
Lane Alignment	Left	Right	L NA	Left	L NA	R NA
Median Width(m)	3.5			5.0	3.5	
Link Offset(m)	0.0			0.0	0.0	
Crosswalk Width(m)	5.0			5.0	5.0	
Two way Left Turn Lane						
Headway Factor	1.09	1.09	1.09	1.09	1.09	1.09
Turning Speed (k/h)		14	24		24	14
Number of Detectors	2	1	1	2	1	1
Detector Template	Thru	Right	Left	Thru	Left	Right
Leading Detector (m)	30.5	6.1	6.1	30.5	6.1	6.1
Trailing Detector (m)	0.0	0.0	0.0	0.0	0.0	0.0
Detector 1 Position(m)	0.0	0.0	0.0	0.0	0.0	0.0
Detector 1 Size(m)	1.8	6.1	6.1	1.8	6.1	6.1
Detector 1 Type	CI+Ex	CI+Ex	CI+Ex	CI+Ex	CI+Ex	CI+Ex
Detector 1 Channel						
Detector 1 Extend (s)	0.0	0.0	0.0	0.0	0.0	0.0
Detector 1 Queue (s)	0.0	0.0	0.0	0.0	0.0	0.0
Detector 1 Delay (s)	0.0	0.0	0.0	0.0	0.0	0.0
Detector 2 Position(m)	28.7			28.7		
Detector 2 Size(m)	1.8			1.8		
Detector 2 Type	CI+Ex			CI+Ex		
Detector 2 Channel						
Detector 2 Extend (s)	0.0			0.0		
Turn Type	NA	Perm	Perm	NA	Prot	Perm
Protected Phases	2			6	8	
Permitted Phases		2	6			8
Detector Phase	2	2	6	6	8	8
Switch Phase						

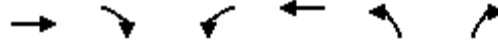

Lane Group	EBT	EBR	WBL	WBT	NBL	NBR
Minimum Initial (s)	10.0	10.0	10.0	10.0	5.0	5.0
Minimum Split (s)	37.0	37.0	37.0	37.0	29.0	29.0
Total Split (s)	81.0	81.0	81.0	81.0	29.0	29.0
Total Split (%)	73.6%	73.6%	73.6%	73.6%	26.4%	26.4%
Maximum Green (s)	75.0	75.0	75.0	75.0	23.0	23.0
Yellow Time (s)	3.3	3.3	3.3	3.3	3.3	3.3
All-Red Time (s)	2.7	2.7	2.7	2.7	2.7	2.7
Lost Time Adjust (s)	0.0	0.0	0.0	0.0	0.0	0.0
Total Lost Time (s)	6.0	6.0	6.0	6.0	6.0	6.0
Lead/Lag						
Lead-Lag Optimize?						
Vehicle Extension (s)	3.0	3.0	3.0	3.0	3.0	3.0
Recall Mode	C-Max	C-Max	C-Max	C-Max	None	None
Walk Time (s)	18.0	18.0			7.0	7.0
Flash Dont Walk (s)	13.0	13.0			16.0	16.0
Pedestrian Calls (#/hr)	5	5			5	5
Act Effct Green (s)	90.6	90.6	90.6	90.6	10.9	10.9
Actuated g/C Ratio	0.82	0.82	0.82	0.82	0.10	0.10
v/c Ratio	0.65	0.05	0.23	0.60	0.30	0.23
Control Delay	2.2	0.7	9.0	6.5	48.0	19.5
Queue Delay	0.0	0.0	0.0	0.5	0.0	0.0
Total Delay	2.3	0.7	9.0	7.1	48.0	19.5
LOS	A	A	A	A	D	B
Approach Delay	2.2			7.1	35.0	
Approach LOS	A			A	D	
Queue Length 50th (m)	16.1	0.1	1.3	49.2	9.4	1.3
Queue Length 95th (m)	22.3	m0.6	8.3	121.0	17.5	9.4
Internal Link Dist (m)	147.1			145.1	104.6	
Turn Bay Length (m)		20.0	65.0		30.0	
Base Capacity (vph)	2679	1192	156	2731	346	332
Starvation Cap Reductn	74	0	0	595	0	0
Spillback Cap Reductn	0	0	0	0	0	0
Storage Cap Reductn	0	0	0	0	0	0
Reduced v/c Ratio	0.67	0.05	0.23	0.77	0.14	0.12

Intersection Summary







Area Type: Other
 Cycle Length: 110
 Actuated Cycle Length: 110
 Offset: 25 (23%), Referenced to phase 2:EBT and 6:WBTL, Start of Green
 Natural Cycle: 80
 Control Type: Actuated-Coordinated
 Maximum v/c Ratio: 0.65
 Intersection Signal Delay: 5.4
 Intersection LOS: A
 Intersection Capacity Utilization 65.5%
 ICU Level of Service C
 Analysis Period (min) 15
 m Volume for 95th percentile queue is metered by upstream signal.

Splits and Phases: 2: 160m W of Conroy & Walkley



3: Conroy & Walkley
PM Peak Hour

2510 St. Laurent Boulevard
2029 Background Traffic (mitigated timing)

							
Lane Group	EBT	EBR	WBL	WBT	NBU	NBL	NBR
Lane Configurations	↑↑	↑	↑↑	↑↑		↑↑	↑
Traffic Volume (vph)	1311	474	537	1171	42	484	328
Future Volume (vph)	1311	474	537	1171	42	484	328
Ideal Flow (vphpl)	1800	1800	1800	1800	1800	1800	1800
Storage Length (m)		75.0	200.0			0.0	0.0
Storage Lanes		1	2			2	1
Taper Length (m)			50.0			10.0	
Lane Util. Factor	0.95	1.00	0.97	0.95	0.95	0.97	1.00
Ped Bike Factor		0.96	0.99				0.96
Frt		0.850					0.850
Flt Protected			0.950			0.950	
Satd. Flow (prot)	3221	1483	3185	3349	0	3248	1469
Flt Permitted			0.950			0.950	
Satd. Flow (perm)	3221	1426	3162	3349	0	3248	1415
Right Turn on Red		Yes					Yes
Satd. Flow (RTOR)		424					328
Link Speed (k/h)	50			50		60	
Link Distance (m)	169.1			271.7		348.5	
Travel Time (s)	12.2			19.6		20.9	
Confl. Peds. (#/hr)		22	22				16
Confl. Bikes (#/hr)		1					1
Peak Hour Factor	1.00	1.00	1.00	1.00	1.00	1.00	1.00
Heavy Vehicles (%)	5%	2%	3%	1%	1%	1%	3%
Adj. Flow (vph)	1311	474	537	1171	42	484	328
Shared Lane Traffic (%)							
Lane Group Flow (vph)	1311	474	537	1171	0	526	328
Enter Blocked Intersection	No	No	No	No	No	No	No
Lane Alignment	Left	R NA	Left	Left	R NA	L NA	R NA
Median Width(m)	7.0			9.0		10.5	
Link Offset(m)	0.0			0.0		0.0	
Crosswalk Width(m)	5.0			5.0		5.0	
Two way Left Turn Lane							
Headway Factor	1.09	1.09	1.09	1.09	1.09	1.09	1.09
Turning Speed (k/h)		14	24		14	24	14
Number of Detectors	2	1	1	2	1	1	1
Detector Template	Thru	Right	Left	Thru	Left	Left	Right
Leading Detector (m)	30.5	6.1	6.1	30.5	6.1	6.1	6.1
Trailing Detector (m)	0.0	0.0	0.0	0.0	0.0	0.0	0.0
Detector 1 Position(m)	0.0	0.0	0.0	0.0	0.0	0.0	0.0
Detector 1 Size(m)	1.8	6.1	6.1	1.8	6.1	6.1	6.1
Detector 1 Type	Cl+Ex	Cl+Ex	Cl+Ex	Cl+Ex	Cl+Ex	Cl+Ex	Cl+Ex
Detector 1 Channel							
Detector 1 Extend (s)	0.0	0.0	0.0	0.0	0.0	0.0	0.0
Detector 1 Queue (s)	0.0	0.0	0.0	0.0	0.0	0.0	0.0
Detector 1 Delay (s)	0.0	0.0	0.0	0.0	0.0	0.0	0.0
Detector 2 Position(m)	28.7			28.7			
Detector 2 Size(m)	1.8			1.8			
Detector 2 Type	Cl+Ex			Cl+Ex			
Detector 2 Channel							
Detector 2 Extend (s)	0.0			0.0			
Turn Type	NA	Perm	Prot	NA	Perm	Prot	Perm
Protected Phases	2		1	6		8	
Permitted Phases		2			8		8
Detector Phase	2	2	1	6	8	8	8



Lane Group	EBT	EBR	WBL	WBT	NBU	NBL	NBR
Switch Phase							
Minimum Initial (s)	10.0	10.0	5.0	10.0	5.0	5.0	5.0
Minimum Split (s)	36.4	36.4	16.0	24.7	30.4	30.4	30.4
Total Split (s)	58.0	58.0	31.0	89.0	31.0	31.0	31.0
Total Split (%)	48.3%	48.3%	25.8%	74.2%	25.8%	25.8%	25.8%
Maximum Green (s)	51.6	51.6	24.8	82.6	24.6	24.6	24.6
Yellow Time (s)	3.7	3.7	3.3	3.7	3.7	3.7	3.7
All-Red Time (s)	2.7	2.7	2.9	2.7	2.7	2.7	2.7
Lost Time Adjust (s)	0.0	0.0	0.0	0.0		0.0	0.0
Total Lost Time (s)	6.4	6.4	6.2	6.4		6.4	6.4
Lead/Lag	Lag	Lag	Lead				
Lead-Lag Optimize?	Yes	Yes	Yes				
Vehicle Extension (s)	3.0	3.0	3.0	3.0	3.0	3.0	3.0
Recall Mode	C-Max	C-Max	None	C-Max	None	None	None
Walk Time (s)	10.0	10.0			7.0	7.0	7.0
Flash Dont Walk (s)	20.0	20.0			17.0	17.0	17.0
Pedestrian Calls (#/hr)	20	20			15	15	15
Act Effct Green (s)	54.4	54.4	23.5	84.0		23.2	23.2
Actuated g/C Ratio	0.45	0.45	0.20	0.70		0.19	0.19
v/c Ratio	0.90	0.54	0.86	0.50		0.84	0.61
Control Delay	40.6	6.0	61.5	9.4		59.5	9.7
Queue Delay	4.8	0.0	0.0	0.0		0.0	0.0
Total Delay	45.3	6.0	61.5	9.4		59.5	9.7
LOS	D	A	E	A		E	A
Approach Delay	34.9			25.8		40.3	
Approach LOS	C			C		D	
Queue Length 50th (m)	141.3	6.3	57.7	57.9		56.2	0.0
Queue Length 95th (m)	#185.3	29.1	#79.5	71.0		74.2	23.3
Internal Link Dist (m)	145.1			247.7		324.5	
Turn Bay Length (m)		75.0	200.0				
Base Capacity (vph)	1459	877	658	2345		665	550
Starvation Cap Reductn	105	7	0	0		0	0
Spillback Cap Reductn	0	0	0	0		0	0
Storage Cap Reductn	0	0	0	0		0	0
Reduced v/c Ratio	0.97	0.54	0.82	0.50		0.79	0.60

Intersection Summary

Area Type: Other
 Cycle Length: 120
 Actuated Cycle Length: 120
 Offset: 20 (17%), Referenced to phase 2:EBT and 6:WBT, Start of Green
 Natural Cycle: 95
 Control Type: Actuated-Coordinated
 Maximum v/c Ratio: 0.90
 Intersection Signal Delay: 32.4 Intersection LOS: C
 Intersection Capacity Utilization 87.8% ICU Level of Service E
 Analysis Period (min) 15
 # 95th percentile volume exceeds capacity, queue may be longer.
 Queue shown is maximum after two cycles.

Splits and Phases: 3: Conroy & Walkley



4: Conroy & St. Laurent
PM Peak Hour

2510 St. Laurent Boulevard
2029 Background Traffic (mitigated timing)

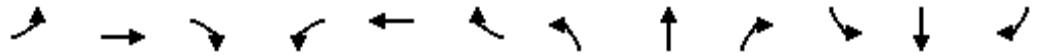

Lane Group	EBL	EBT	EBR	WBL	WBT	WBR	NBL	NBT	NBR	SBL	SBT	SBR
Lane Configurations												
Traffic Volume (vph)	41	77	316	232	34	102	40	595	81	37	1111	13
Future Volume (vph)	41	77	316	232	34	102	40	595	81	37	1111	13
Ideal Flow (vphpl)	1800	1800	1800	1800	1800	1800	1800	1800	1800	1800	1800	1800
Storage Length (m)	45.0		50.0	55.0		55.0	0.0		0.0	110.0		0.0
Storage Lanes	1		1	1		1	1		0	1		0
Taper Length (m)	40.0			40.0			10.0			25.0		
Lane Util. Factor	1.00	1.00	1.00	1.00	1.00	1.00	1.00	0.91	0.91	1.00	0.95	0.95
Ped Bike Factor	1.00		0.98	1.00		0.99		0.99		0.99	1.00	
Fr			0.850			0.850		0.982			0.998	
Flt Protected	0.950			0.950			0.950			0.950		
Satd. Flow (prot)	1674	1728	1483	1642	1618	1483	1642	4619	0	1537	3303	0
Flt Permitted	0.735			0.555			0.155			0.371		
Satd. Flow (perm)	1293	1728	1461	957	1618	1463	268	4619	0	595	3303	0
Right Turn on Red			Yes			Yes			Yes			Yes
Satd. Flow (RTOR)			121			78		27			1	
Link Speed (k/h)		50			50			60			60	
Link Distance (m)		197.7			271.8			372.7			348.5	
Travel Time (s)		14.2			19.6			22.4			20.9	
Confl. Peds. (#/hr)	2		4	4		2	8		12	12		8
Confl. Bikes (#/hr)									4			11
Peak Hour Factor	1.00	1.00	1.00	1.00	1.00	1.00	1.00	1.00	1.00	1.00	1.00	1.00
Heavy Vehicles (%)	1%	3%	2%	3%	10%	2%	3%	2%	8%	10%	2%	12%
Adj. Flow (vph)	41	77	316	232	34	102	40	595	81	37	1111	13
Shared Lane Traffic (%)												
Lane Group Flow (vph)	41	77	316	232	34	102	40	676	0	37	1124	0
Enter Blocked Intersection	No	No	No	No	No	No	No	No	No	No	No	No
Lane Alignment	L NA	Left	R NA	L NA	Left	R NA	Left	Left	Right	L NA	Left	R NA
Median Width(m)		3.5			3.5			7.0			6.0	
Link Offset(m)		0.0			0.0			0.0			0.0	
Crosswalk Width(m)		5.0			5.0			5.0			5.0	
Two way Left Turn Lane												
Headway Factor	1.09	1.09	1.09	1.09	1.09	1.09	1.09	1.09	1.09	1.09	1.09	1.09
Turning Speed (k/h)	24		14	24		14	24		14	24		14
Number of Detectors	1	2	1	1	2	1	1	2		1	2	
Detector Template	Left	Thru	Right	Left	Thru	Right	Left	Thru		Left	Thru	
Leading Detector (m)	6.1	30.5	6.1	6.1	30.5	6.1	6.1	30.5		6.1	30.5	
Trailing Detector (m)	0.0	0.0	0.0	0.0	0.0	0.0	0.0	0.0		0.0	0.0	
Detector 1 Position(m)	0.0	0.0	0.0	0.0	0.0	0.0	0.0	0.0		0.0	0.0	
Detector 1 Size(m)	6.1	1.8	6.1	6.1	1.8	6.1	6.1	1.8		6.1	1.8	
Detector 1 Type	Cl+Ex	Cl+Ex	Cl+Ex	Cl+Ex	Cl+Ex	Cl+Ex	Cl+Ex	Cl+Ex		Cl+Ex	Cl+Ex	
Detector 1 Channel												
Detector 1 Extend (s)	0.0	0.0	0.0	0.0	0.0	0.0	0.0	0.0		0.0	0.0	
Detector 1 Queue (s)	0.0	0.0	0.0	0.0	0.0	0.0	0.0	0.0		0.0	0.0	
Detector 1 Delay (s)	0.0	0.0	0.0	0.0	0.0	0.0	0.0	0.0		0.0	0.0	
Detector 2 Position(m)		28.7			28.7			28.7			28.7	
Detector 2 Size(m)		1.8			1.8			1.8			1.8	
Detector 2 Type		Cl+Ex			Cl+Ex			Cl+Ex			Cl+Ex	
Detector 2 Channel												
Detector 2 Extend (s)		0.0			0.0			0.0			0.0	
Turn Type	Perm	NA	Perm	pm+pt	NA	Perm	Perm	NA		Perm	NA	
Protected Phases		4		3	8			2			6	
Permitted Phases	4		4	8		8	2			6		
Detector Phase	4	4	4	3	8	8	2	2		6	6	

4: Conroy & St. Laurent
PM Peak Hour

2510 St. Laurent Boulevard
2029 Background Traffic (mitigated timing)

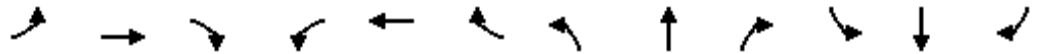

Lane Group	EBL	EBT	EBR	WBL	WBT	WBR	NBL	NBT	NBR	SBL	SBT	SBR
Switch Phase												
Minimum Initial (s)	10.0	10.0	10.0	5.0	10.0	10.0	10.0	10.0		10.0	10.0	
Minimum Split (s)	43.9	43.9	43.9	11.3	43.9	43.9	30.3	30.3		30.3	30.3	
Total Split (s)	44.0	44.0	44.0	15.0	59.0	59.0	36.0	36.0		36.0	36.0	
Total Split (%)	46.3%	46.3%	46.3%	15.8%	62.1%	62.1%	37.9%	37.9%		37.9%	37.9%	
Maximum Green (s)	37.1	37.1	37.1	9.3	52.1	52.1	29.7	29.7		29.7	29.7	
Yellow Time (s)	3.3	3.3	3.3	3.3	3.3	3.3	3.7	3.7		3.7	3.7	
All-Red Time (s)	3.6	3.6	3.6	2.4	3.6	3.6	2.6	2.6		2.6	2.6	
Lost Time Adjust (s)	0.0	0.0	0.0	0.0	0.0	0.0	0.0	0.0		0.0	0.0	
Total Lost Time (s)	6.9	6.9	6.9	5.7	6.9	6.9	6.3	6.3		6.3	6.3	
Lead/Lag	Lag	Lag	Lag	Lead								
Lead-Lag Optimize?	Yes	Yes	Yes	Yes								
Vehicle Extension (s)	3.0	3.0	3.0	3.0	3.0	3.0	3.0	3.0		3.0	3.0	
Recall Mode	None	None	None	None	None	None	C-Max	C-Max		C-Max	C-Max	
Walk Time (s)	7.0	7.0	7.0		7.0	7.0	7.0	7.0		7.0	7.0	
Flash Dont Walk (s)	30.0	30.0	30.0		30.0	30.0	17.0	17.0		17.0	17.0	
Pedestrian Calls (#/hr)	5	5	5		5	5	10	10		10	10	
Act Effct Green (s)	20.9	20.9	20.9	37.1	35.9	35.9	45.9	45.9		45.9	45.9	
Actuated g/C Ratio	0.22	0.22	0.22	0.39	0.38	0.38	0.48	0.48		0.48	0.48	
v/c Ratio	0.14	0.20	0.76	0.53	0.06	0.17	0.31	0.30		0.13	0.70	
Control Delay	26.5	27.8	31.6	23.5	15.3	5.6	29.7	16.5		20.1	25.0	
Queue Delay	0.0	0.0	0.0	0.0	0.0	0.0	0.0	0.0		0.0	0.0	
Total Delay	26.5	27.8	31.6	23.5	15.3	5.6	29.7	16.5		20.1	25.0	
LOS	C	C	C	C	B	A	C	B		C	C	
Approach Delay		30.5			17.8			17.3			24.9	
Approach LOS		C			B			B			C	
Queue Length 50th (m)	5.8	11.0	32.2	28.4	3.7	2.6	3.8	22.1		3.2	71.5	
Queue Length 95th (m)	10.4	16.5	45.3	30.7	6.4	8.2	#18.4	42.1		12.1	#149.8	
Internal Link Dist (m)		173.7			247.8			348.7			324.5	
Turn Bay Length (m)	45.0		50.0	55.0		55.0				110.0		
Base Capacity (vph)	504	674	644	440	887	837	129	2244		287	1595	
Starvation Cap Reductn	0	0	0	0	0	0	0	0		0	0	
Spillback Cap Reductn	0	0	0	0	0	0	0	0		0	0	
Storage Cap Reductn	0	0	0	0	0	0	0	0		0	0	
Reduced v/c Ratio	0.08	0.11	0.49	0.53	0.04	0.12	0.31	0.30		0.13	0.70	

Intersection Summary

Area Type: Other
 Cycle Length: 95
 Actuated Cycle Length: 95
 Offset: 2 (2%), Referenced to phase 2:NBTL and 6:SBTL, Start of Green
 Natural Cycle: 90
 Control Type: Actuated-Coordinated
 Maximum v/c Ratio: 0.76
 Intersection Signal Delay: 22.8 Intersection LOS: C
 Intersection Capacity Utilization 84.5% ICU Level of Service E
 Analysis Period (min) 15
 # 95th percentile volume exceeds capacity, queue may be longer.
 Queue shown is maximum after two cycles.

Splits and Phases: 4: Conroy & St. Laurent

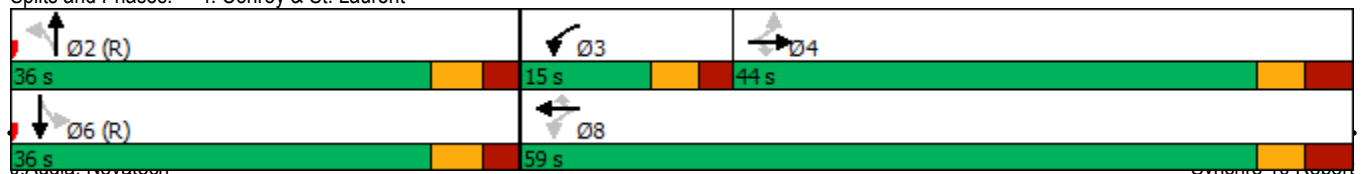



Lane Group	WBL	WBR	NBT	NBR	SBL	SBT
Lane Configurations						
Traffic Volume (vph)	23	56	107	76	151	51
Future Volume (vph)	23	56	107	76	151	51
Ideal Flow (vphpl)	1800	1800	1800	1800	1800	1800
Lane Util. Factor	1.00	1.00	1.00	1.00	1.00	1.00
Ped Bike Factor						
Frt	0.904		0.944			
Flt Protected	0.986					0.964
Satd. Flow (prot)	1481	0	1641	0	0	1588
Flt Permitted	0.986					0.964
Satd. Flow (perm)	1481	0	1641	0	0	1588
Link Speed (k/h)	50		50			50
Link Distance (m)	137.6		234.0			146.3
Travel Time (s)	9.9		16.8			10.5
Confl. Peds. (#/hr)				2	2	
Confl. Bikes (#/hr)		1		4		
Peak Hour Factor	1.00	1.00	1.00	1.00	1.00	1.00
Heavy Vehicles (%)	5%	8%	2%	3%	4%	20%
Adj. Flow (vph)	23	56	107	76	151	51
Shared Lane Traffic (%)						
Lane Group Flow (vph)	79	0	183	0	0	202
Enter Blocked Intersection	No	No	No	No	No	No
Lane Alignment	Left	Right	Left	Right	Left	Left
Median Width(m)	3.5		0.0			0.0
Link Offset(m)	0.0		0.0			0.0
Crosswalk Width(m)	2.0		10.0			10.0
Two way Left Turn Lane						
Headway Factor	1.09	1.09	1.09	1.09	1.09	1.09
Turning Speed (k/h)	24	14		14	24	
Sign Control	Stop		Free			Free

Intersection Summary

Area Type: Other

Control Type: Unsignalized

Intersection Capacity Utilization 37.7% ICU Level of Service A

Analysis Period (min) 15

APPENDIX L

Transportation Demand Management

TDM-Supportive Development Design and Infrastructure Checklist:
Residential Developments (multi-family or condominium)

Legend	
REQUIRED	The Official Plan or Zoning By-law provides related guidance that must be followed
BASIC	The measure is generally feasible and effective, and in most cases would benefit the development and its users
BETTER	The measure could maximize support for users of sustainable modes, and optimize development performance

TDM-supportive design & infrastructure measures: <i>Residential developments</i>		Check if completed & add descriptions, explanations or plan/drawing references
1. WALKING & CYCLING: ROUTES		
1.1 Building location & access points		
BASIC	1.1.1 Locate building close to the street, and do not locate parking areas between the street and building entrances	<input checked="" type="checkbox"/>
BASIC	1.1.2 Locate building entrances in order to minimize walking distances to sidewalks and transit stops/stations	<input checked="" type="checkbox"/>
BASIC	1.1.3 Locate building doors and windows to ensure visibility of pedestrians from the building, for their security and comfort	<input checked="" type="checkbox"/>
1.2 Facilities for walking & cycling		
REQUIRED	1.2.1 Provide convenient, direct access to stations or major stops along rapid transit routes within 600 metres; minimize walking distances from buildings to rapid transit; provide pedestrian-friendly, weather-protected (where possible) environment between rapid transit accesses and building entrances; ensure quality linkages from sidewalks through building entrances to integrated stops/stations <i>(see Official Plan policy 4.3.3)</i>	<input type="checkbox"/> - n/a
REQUIRED	1.2.2 Provide safe, direct and attractive pedestrian access from public sidewalks to building entrances through such measures as: reducing distances between public sidewalks and major building entrances; providing walkways from public streets to major building entrances; within a site, providing walkways along the front of adjoining buildings, between adjacent buildings, and connecting areas where people may congregate, such as courtyards and transit stops; and providing weather protection through canopies, colonnades, and other design elements wherever possible <i>(see Official Plan policy 4.3.12)</i>	<input checked="" type="checkbox"/>

TDM-supportive design & infrastructure measures: <i>Residential developments</i>		Check if completed & add descriptions, explanations or plan/drawing references
REQUIRED	1.2.3 Provide sidewalks of smooth, well-drained walking surfaces of contrasting materials or treatments to differentiate pedestrian areas from vehicle areas, and provide marked pedestrian crosswalks at intersection sidewalks (<i>see Official Plan policy 4.3.10</i>)	<input checked="" type="checkbox"/>
REQUIRED	1.2.4 Make sidewalks and open space areas easily accessible through features such as gradual grade transition, depressed curbs at street corners and convenient access to extra-wide parking spaces and ramps (<i>see Official Plan policy 4.3.10</i>)	<input checked="" type="checkbox"/>
REQUIRED	1.2.5 Include adequately spaced inter-block/street cycling and pedestrian connections to facilitate travel by active transportation. Provide links to the existing or planned network of public sidewalks, multi-use pathways and on-road cycle routes. Where public sidewalks and multi-use pathways intersect with roads, consider providing traffic control devices to give priority to cyclists and pedestrians (<i>see Official Plan policy 4.3.11</i>)	<input checked="" type="checkbox"/>
BASIC	1.2.6 Provide safe, direct and attractive walking routes from building entrances to nearby transit stops	<input checked="" type="checkbox"/>
BASIC	1.2.7 Ensure that walking routes to transit stops are secure, visible, lighted, shaded and wind-protected wherever possible	<input type="checkbox"/>
BASIC	1.2.8 Design roads used for access or circulation by cyclists using a target operating speed of no more than 30 km/h, or provide a separated cycling facility	<input checked="" type="checkbox"/>
1.3 Amenities for walking & cycling		
BASIC	1.3.1 Provide lighting, landscaping and benches along walking and cycling routes between building entrances and streets, sidewalks and trails	<input type="checkbox"/>
BASIC	1.3.2 Provide wayfinding signage for site access (where required, e.g. when multiple buildings or entrances exist) and egress (where warranted, such as when directions to reach transit stops/stations, trails or other common destinations are not obvious)	<input type="checkbox"/>

TDM-supportive design & infrastructure measures: <i>Residential developments</i>		Check if completed & add descriptions, explanations or plan/drawing references
2. WALKING & CYCLING: END-OF-TRIP FACILITIES		
2.1 Bicycle parking		
REQUIRED	2.1.1 Provide bicycle parking in highly visible and lighted areas, sheltered from the weather wherever possible (see <i>Official Plan policy 4.3.6</i>)	<input checked="" type="checkbox"/> - Garage is provided for each unit
REQUIRED	2.1.2 Provide the number of bicycle parking spaces specified for various land uses in different parts of Ottawa; provide convenient access to main entrances or well-used areas (see <i>Zoning By-law Section 111</i>)	<input checked="" type="checkbox"/> - Garage is provided for each unit
REQUIRED	2.1.3 Ensure that bicycle parking spaces and access aisles meet minimum dimensions; that no more than 50% of spaces are vertical spaces; and that parking racks are securely anchored (see <i>Zoning By-law Section 111</i>)	<input checked="" type="checkbox"/> - Garage is provided for each unit
BASIC	2.1.4 Provide bicycle parking spaces equivalent to the expected number of resident-owned bicycles, plus the expected peak number of visitor cyclists	<input checked="" type="checkbox"/>
2.2 Secure bicycle parking		
REQUIRED	2.2.1 Where more than 50 bicycle parking spaces are provided for a single residential building, locate at least 25% of spaces within a building/structure, a secure area (e.g. supervised parking lot or enclosure) or bicycle lockers (see <i>Zoning By-law Section 111</i>)	<input type="checkbox"/> - n/a
BETTER	2.2.2 Provide secure bicycle parking spaces equivalent to at least the number of units at condominiums or multi-family residential developments	<input type="checkbox"/>
2.3 Bicycle repair station		
BETTER	2.3.1 Provide a permanent bike repair station, with commonly used tools and an air pump, adjacent to the main bicycle parking area (or secure bicycle parking area, if provided)	<input type="checkbox"/>
3. TRANSIT		
3.1 Customer amenities		
BASIC	3.1.1 Provide shelters, lighting and benches at any on-site transit stops	<input type="checkbox"/>
BASIC	3.1.2 Where the site abuts an off-site transit stop and insufficient space exists for a transit shelter in the public right-of-way, protect land for a shelter and/or install a shelter	<input type="checkbox"/>
BETTER	3.1.3 Provide a secure and comfortable interior waiting area by integrating any on-site transit stops into the building	<input type="checkbox"/>

TDM-supportive design & infrastructure measures: <i>Residential developments</i>		Check if completed & add descriptions, explanations or plan/drawing references
4. RIDESHARING		
4.1 Pick-up & drop-off facilities		
BASIC	4.1.1 Provide a designated area for carpool drivers (plus taxis and ride-hailing services) to drop off or pick up passengers without using fire lanes or other no-stopping zones	<input type="checkbox"/>
5. CARSHARING & BIKESHARING		
5.1 Carshare parking spaces		
BETTER	5.1.1 Provide up to three carshare parking spaces in an R3, R4 or R5 Zone for specified residential uses (<i>see Zoning By-law Section 94</i>)	<input type="checkbox"/>
5.2 Bikeshare station location		
BETTER	5.2.1 Provide a designated bikeshare station area near a major building entrance, preferably lighted and sheltered with a direct walkway connection	<input type="checkbox"/>
6. PARKING		
6.1 Number of parking spaces		
REQUIRED	6.1.1 Do not provide more parking than permitted by zoning, nor less than required by zoning, unless a variance is being applied for	<input checked="" type="checkbox"/>
BASIC	6.1.2 Provide parking for long-term and short-term users that is consistent with mode share targets, considering the potential for visitors to use off-site public parking	<input type="checkbox"/>
BASIC	6.1.3 Where a site features more than one use, provide shared parking and reduce the cumulative number of parking spaces accordingly (<i>see Zoning By-law Section 104</i>)	<input type="checkbox"/>
BETTER	6.1.4 Reduce the minimum number of parking spaces required by zoning by one space for each 13 square metres of gross floor area provided as shower rooms, change rooms, locker rooms and other facilities for cyclists in conjunction with bicycle parking (<i>see Zoning By-law Section 111</i>)	<input type="checkbox"/>
6.2 Separate long-term & short-term parking areas		
BETTER	6.2.1 Provide separate areas for short-term and long-term parking (using signage or physical barriers) to permit access controls and simplify enforcement (i.e. to discourage residents from parking in visitor spaces, and vice versa)	<input type="checkbox"/>

TDM Measures Checklist:
Residential Developments (multi-family, condominium or subdivision)

Legend	
BASIC	The measure is generally feasible and effective, and in most cases would benefit the development and its users
BETTER	The measure could maximize support for users of sustainable modes, and optimize development performance
★	The measure is one of the most dependably effective tools to encourage the use of sustainable modes

TDM measures: Residential developments		Check if proposed & add descriptions
1. TDM PROGRAM MANAGEMENT		
1.1 Program coordinator		
BASIC	★ 1.1.1 Designate an internal coordinator, or contract with an external coordinator	<input type="checkbox"/>
1.2 Travel surveys		
BETTER	1.2.1 Conduct periodic surveys to identify travel-related behaviours, attitudes, challenges and solutions, and to track progress	<input type="checkbox"/>
2. WALKING AND CYCLING		
2.1 Information on walking/cycling routes & destinations		
BASIC	2.1.1 Display local area maps with walking/cycling access routes and key destinations at major entrances <i>(multi-family, condominium)</i>	<input checked="" type="checkbox"/>
2.2 Bicycle skills training		
BETTER	2.2.1 Offer on-site cycling courses for residents, or subsidize off-site courses	<input type="checkbox"/>

TDM measures: <i>Residential developments</i>		Check if proposed & add descriptions
3. TRANSIT		
3.1 Transit information		
BASIC	3.1.1 Display relevant transit schedules and route maps at entrances (<i>multi-family, condominium</i>)	<input checked="" type="checkbox"/>
BETTER	3.1.2 Provide real-time arrival information display at entrances (<i>multi-family, condominium</i>)	<input type="checkbox"/>
3.2 Transit fare incentives		
BASIC	★ 3.2.1 Offer PRESTO cards preloaded with one monthly transit pass on residence purchase/move-in, to encourage residents to use transit	<input type="checkbox"/>
BETTER	3.2.2 Offer at least one year of free monthly transit passes on residence purchase/move-in	<input type="checkbox"/>
3.3 Enhanced public transit service		
BETTER	★ 3.3.1 Contract with OC Transpo to provide early transit services until regular services are warranted by occupancy levels (<i>subdivision</i>)	<input type="checkbox"/>
3.4 Private transit service		
BETTER	3.4.1 Provide shuttle service for seniors homes or lifestyle communities (e.g. scheduled mall or supermarket runs)	<input type="checkbox"/>
4. CARSHARING & BIKESHARING		
4.1 Bikeshare stations & memberships		
BETTER	4.1.1 Contract with provider to install on-site bikeshare station (<i>multi-family</i>)	<input type="checkbox"/>
BETTER	4.1.2 Provide residents with bikeshare memberships, either free or subsidized (<i>multi-family</i>)	<input type="checkbox"/>
4.2 Carshare vehicles & memberships		
BETTER	4.2.1 Contract with provider to install on-site carshare vehicles and promote their use by residents	<input type="checkbox"/>
BETTER	4.2.2 Provide residents with carshare memberships, either free or subsidized	<input type="checkbox"/>
5. PARKING		
5.1 Priced parking		
BASIC	★ 5.1.1 Unbundle parking cost from purchase price (<i>condominium</i>)	<input type="checkbox"/>
BASIC	★ 5.1.2 Unbundle parking cost from monthly rent (<i>multi-family</i>)	<input type="checkbox"/>

TDM measures: Residential developments		Check if proposed & add descriptions
6. TDM MARKETING & COMMUNICATIONS		
6.1 Multimodal travel information		
BASIC ★	6.1.1 Provide a multimodal travel option information package to new residents	<input checked="" type="checkbox"/>
6.2 Personalized trip planning		
BETTER ★	6.2.1 Offer personalized trip planning to new residents	<input type="checkbox"/>

APPENDIX M

MMLOS Analysis

Segment MMLOS Analysis

This section provides a review of the boundary streets Walkley Road, Conroy Road, St. Laurent Boulevard, and Don Reid Drive, using complete streets principles. The *Multi-Modal Level of Service (MMLOS) Guidelines*, produced by IBI Group in October 2015, were used to evaluate the levels of service for each alternative mode of transportation on the boundary streets. As each boundary street is located within both the General Urban Area and Urban Employment Area, whichever target is more stringent has been considered.

Exhibit 4 of the *MMLOS Guidelines* has been used to evaluate the segment pedestrian level of service (PLOS) of the boundary streets. Exhibit 22 of the *MMLOS Guidelines* identifies a target PLOS C for all roadways in the General Urban Area or Employment Area. The results of the segment PLOS analysis are summarized in **Table 1**.

Exhibit 11 of the *MMLOS Guidelines* has been used to evaluate the segment bicycle level of service (BLOS) of the boundary streets. In the General Urban Area, Exhibit 22 of the *MMLOS Guidelines* identifies a target BLOS B for roadways with a Crosstown Bikeway designation (Walkley Road, Conroy Road) or Local Route designation (St. Laurent Boulevard, Don Reid Drive). The results of the segment BLOS analysis are summarized in **Table 2**.

Exhibit 15 of the *MMLOS Guidelines* has been used to evaluate the segment transit level of service (TLOS) of the boundary streets. Within the General Urban Area or Employment Area, Exhibit 22 of the *MMLOS Guidelines* identifies a target TLOS B for roadways with a Rapid Transit Corridor designation in the RTTP Network Concept (Walkley Road), and a target TLOS D for roadways with a Transit Priority with Isolated Measures designation (Conroy Road). St. Laurent Boulevard and Don Reid Drive have not been evaluated for segment TLOS. The results of the segment TLOS analysis are summarized in **Table 3**.

Exhibit 20 of the *MMLOS Guidelines* has been used to evaluate the segment truck level of service (TkLOS) of the boundary streets. Within the Employment Area, Exhibit 22 of the *MMLOS Guidelines* identifies a target TkLOS B for arterial roadways with a truck route designation (Walkley Road, Conroy Road), and a target TkLOS D for collector roadways without a truck route designation (St. Laurent Boulevard, Don Reid Drive). The results of the segment TkLOS analysis are summarized in **Table 4**.

Table 1: PLOS Segment Analysis

Sidewalk Width	Boulevard Width	Avg. Daily Curb Lane Traffic Volume	Presence of On-Street Parking	Operating Speed ⁽¹⁾	PLOS
Walkley Road (north side, Ryder Street to 160m West of Conroy Road)					
1.5m	> 2.0m	> 3,000 vpd	No	60 km/h	E
Walkley Road (south side, Don Reid Drive to 160m West of Conroy Road)					
≥ 2.0m	0m	> 3,000 vpd	No	60 km/h	E
Conroy Road (east side, Walkley Road to St. Laurent Boulevard)					
1.5m	> 2.0m	> 3,000 vpd	No	70 km/h	E
Conroy Road (west side, Walkley Road to St. Laurent Boulevard)					
≥ 2.0m	> 2.0m	> 3,000 vpd	No	70 km/h	D
St. Laurent Boulevard (north side, Don Reid Drive to Conroy Road)					
1.5m	0.5 to 2.0m	≤ 3,000 vpd	No	60 km/h	C
St. Laurent Boulevard (south side, Don Reid Drive to Conroy Road)					
No sidewalk		≤ 3,000 vpd	No	60 km/h	F
Don Reid Drive (east side, Walkley Road to St. Laurent Boulevard)					
1.5m	0.5 to 2.0m	≤ 3,000 vpd	No	60 km/h	C
Don Reid Drive (west side, Walkley Road to St. Laurent Boulevard)					
No sidewalk		≤ 3,000 vpd	No	60 km/h	F

1. Operating speed taken as the speed limit plus 10 km/h.

Table 2: BLOS Segment Analysis

Road Class	Route Type	Bikeway Type	Travel Lanes	Operating Speed	Bike Lane Width	Bike Lane Blockage	BLOS
Walkley Road (Don Reid Drive/Ryder Street to 160m West of Conroy Road)							
Arterial	Crosstown Bikeway	Mixed Traffic	4	60 km/h	N/A	N/A	F
Conroy Road (Walkley Road to St. Laurent Boulevard)							
Arterial	Crosstown Bikeway	Curbside Bike Lane	4 to 5	70 km/h	≥ 1.8m	Rare	E
		Mixed-Use Pathway	N/A	N/A	N/A	N/A	A
St. Laurent Boulevard (Don Reid Drive to Conroy Road)							
Collector	Local Route	Mixed Traffic	2	60 km/h	N/A	N/A	F
Don Reid Drive (Walkley Road to St. Laurent Boulevard)							
Collector	Local Route	Mixed Traffic	2	60 km/h	N/A	N/A	F

Table 3: TLOS Segment Analysis

Facility Type	Exposure to Congestion Delay, Friction, and Incidents			TLOS
	Congestion	Friction	Incident Potential	
Walkley Road (Don Reid Drive/Ryder Street to 160m West of Conroy Road)				
Mixed Traffic – Limited Parking/Driveway Friction	Yes	Low	Medium	D
Conroy Road (Walkley Road to St. Laurent Boulevard)				
Mixed Traffic – Limited Parking/Driveway Friction	Yes	Low	Medium	D

Table 4: TkLOS Segment Analysis

Curb Lane Width	Number of Travel Lanes Per Direction	TkLOS
Walkley Road (Don Reid Drive/Ryder Street to 160m West of Conroy Road)		
> 3.7m	2	A
Conroy Road (Walkley Road to St. Laurent Boulevard)		
3.5 to 3.7m	2 to 3	A
St. Laurent Boulevard (Don Reid Drive to Conroy Road)		
> 3.7m	1	B
Don Reid Drive (Walkley Road to St. Laurent Boulevard)		
> 3.7m	1	B

Intersection MMLOS Analysis

The following is a review of the MMLOS of the signalized intersections within the study area (Walkley Road/Don Reid Drive/Ryder Street, Walkley Road/160m West of Conroy Road, Walkley Road/Conroy Road, and St. Laurent Boulevard/Conroy Road), using complete streets principles. All of these intersections have been evaluated based on existing conditions, using the MMLOS targets for intersections within the General Urban Area or Employment Area, whichever are stricter.

Exhibit 5 of the *Addendum to the MMLOS Guidelines* has been used to evaluate the existing PLOS at the intersections listed above. Exhibit 22 of the *MMLOS Guidelines* identifies a target PLOS C for all roadways in the General Urban Area or Employment Area. The results of the intersection PLOS analysis are summarized in **Table 5** through **Table 8**.

Exhibit 12 of the *MMLOS Guidelines* has been used to evaluate the existing BLOS at the intersections listed above. In the General Urban Area, Exhibit 22 of the *MMLOS Guidelines* identifies a target BLOS B for Crosstown Bikeways (Conroy Road, Walkley Road), and a target BLOS B for Local Cycling Routes (Don Reid Drive, Ryder Street, St. Laurent Boulevard). The results of the intersection BLOS analysis are summarized in **Table 9**.

Exhibit 16 of the *MMLOS Guidelines* has been used to evaluate the existing TLOS at the intersections listed above. Exhibit 22 of the *MMLOS Guidelines* identifies a target TLOS B for Rapid Transit Corridors (Walkley Road) and a target TLOS D for Transit Priority Corridors with Isolated Measures (Conroy Road). The TLOS has been evaluated for every approach that is currently utilized by transit at the study area intersections. The results of the intersection TLOS analysis are summarized in **Table 10**.

Exhibit 21 of the *MMLOS Guidelines* has been used to evaluate the existing TkLOS at the intersections listed above. In the Employment Area, Exhibit 22 of the *MMLOS Guidelines* identifies a target TkLOS B for arterial truck routes (Walkley Road, Conroy Road), a target TkLOS D for collector roadways without a truck route designation (St. Laurent Boulevard, Don Reid Drive), and a target TkLOS E for local roadways without a truck route designation (Ryder Street). The results of the intersection TkLOS analysis are summarized in **Table 11**.

Table 5: PLOS Intersection Analysis – Walkley Road/Don Reid Drive/Ryder Street

CRITERIA	North Approach		South Approach		East Approach		West Approach	
PETSI SCORE								
<i>CROSSING DISTANCE CONDITIONS</i>								
Median > 2.4m in Width	No	72	No	39	No	39	No	6
Lanes Crossed (3.5m Lane Width)	5		7		7		9	
<i>SIGNAL PHASING AND TIMING</i>								
Left Turn Conflict	Permissive	-8	Permissive	-8	Permissive	-8	Permissive	-8
Right Turn Conflict	Permissive or Yield	-5	Permissive or Yield	-5	Permissive or Yield	-5	Permissive or Yield	-5
Right Turn on Red	RTOR Allowed	-3	RTOR Allowed	-3	RTOR Allowed	-3	RTOR Allowed	-3
Leading Pedestrian Interval	No	-2	No	-2	No	-2	No	-2
<i>CORNER RADIUS</i>								
Parallel Radius	> 10m to 15m	-6	> 10m to 15m	-6	> 10m to 15m	-6	> 10m to 15m	-6
Parallel Right Turn Channel	No Right Turn Channel	-4	No Right Turn Channel	-4	No Right Turn Channel	-4	No Right Turn Channel	-4
Perpendicular Radius	N/A	0	N/A	0	N/A	0	N/A	0
Perpendicular Right Turn Channel	N/A	0	N/A	0	N/A	0	N/A	0
<i>CROSSING TREATMENT</i>								
Treatment	Standard	-7	Standard	-7	Standard	-7	Standard	-7
	PETSI SCORE	37		4		4		-29
	LOS	E		F		F		F
DELAY SCORE								
Cycle Length		100		100		110		110
Pedestrian Walk Time		43.1		43.1		10.1		10.1
	DELAY SCORE	16.2		16.2		45.4		45.4
	LOS	B		B		E		E
	OVERALL	E		F		F		F

Table 6: PLOS Intersection Analysis – Walkley Road/160m West of Conroy Road

CRITERIA	North Approach		South Approach		East Approach		West Approach	
PETSI SCORE								
<i>CROSSING DISTANCE CONDITIONS</i>								
Median > 2.4m in Width	N/A	0	No	55	No	39	No	39
Lanes Crossed (3.5m Lane Width)	N/A		6		7		7	
<i>SIGNAL PHASING AND TIMING</i>								
Left Turn Conflict	N/A	0	Permissive	-8	No Left Turn/Prohibited	0	Permissive	-8
Right Turn Conflict	N/A	0	Permissive or Yield	-5	Permissive or Yield	-5	No Right Turn/Prohibited	0
Right Turn on Red	N/A	0	RTOR Allowed	-3	N/A	0	RTOR Allowed	-3
Leading Pedestrian Interval	N/A	0	No	-2	No	-2	No	-2
<i>CORNER RADIUS</i>								
Parallel Radius	N/A	0	> 10m to 15m	-6	> 10m to 15m	-6	No Right Turn	0
Parallel Right Turn Channel	N/A	0	No Right Turn Channel	-4	No Right Turn Channel	-4	No Right Turn	0
Perpendicular Radius	N/A	0	N/A	0	N/A	0	N/A	0
Perpendicular Right Turn Channel	N/A	0	N/A	0	N/A	0	N/A	0
<i>CROSSING TREATMENT</i>								
Treatment	N/A	0	Standard	-7	Standard	-7	Standard	-7
	PETSI SCORE	-		20		15		19
	LOS	-		F		F		F
DELAY SCORE								
Cycle Length		0		100		110		110
Pedestrian Walk Time		0.0		52.0		7.0		7.0
	DELAY SCORE	-		11.5		48.2		48.2
	LOS	-		B		E		E
	OVERALL	-		F		F		F

Table 7: PLOS Intersection Analysis – Walkley Road/Conroy Road

CRITERIA	North Approach		South Approach		East Approach		West Approach	
PETSI SCORE								
<i>CROSSING DISTANCE CONDITIONS</i>								
Median > 2.4m in Width	N/A	0	No	-10	No	6	N/A	0
Lanes Crossed (3.5m Lane Width)	N/A		10 +		9		N/A	
<i>SIGNAL PHASING AND TIMING</i>								
Left Turn Conflict	N/A	0	Protected	0	No Left Turn/Prohibited	0	N/A	0
Right Turn Conflict	N/A	0	Permissive or Yield	-5	Permissive or Yield	-5	N/A	0
Right Turn on Red	N/A	0	N/A	0	N/A	0	N/A	0
Leading Pedestrian Interval	N/A	0	No	-2	No	-2	N/A	0
<i>CORNER RADIUS</i>								
Parallel Radius	N/A	0	> 15m to 25m	-8	> 15m to 25m	-8	N/A	0
Parallel Right Turn Channel	N/A	0	Conventional without Receiving	0	Conventional with Receiving	-3	N/A	0
Perpendicular Radius	N/A	0	> 15m to 25m	-8	N/A	0	N/A	0
Perpendicular Right Turn Channel	N/A	0	Conventional with Receiving	-3	N/A	0	N/A	0
<i>CROSSING TREATMENT</i>								
Treatment	N/A	0	Standard	-7	Standard	-7	N/A	0
		PETSI SCORE		-43		-19		
		LOS		F		F		
DELAY SCORE								
Cycle Length		0		120		120		0
Pedestrian Walk Time		0.0		28.6		16.6		0.0
		DELAY SCORE		34.8		44.5		
		LOS		D		E		
		OVERALL		F		F		

Table 8: PLOS Intersection Analysis – St. Laurent Boulevard/Conroy Road

CRITERIA	North Approach		South Approach		East Approach		West Approach	
PETSI SCORE								
<i>CROSSING DISTANCE CONDITIONS</i>								
Median > 2.4m in Width	No	-10	No	-10	No	55	No	55
Lanes Crossed (3.5m Lane Width)	10 +		10 +		6		6	
<i>SIGNAL PHASING AND TIMING</i>								
Left Turn Conflict	Permissive	-8	Perm + Prot	-8	Permissive	-8	Permissive	-8
Right Turn Conflict	Permissive or Yield	-5	Permissive or Yield	-5	Permissive or Yield	-5	Permissive or Yield	-5
Right Turn on Red	RTOR Allowed	-3	RTOR Allowed	-3	RTOR Allowed	-3	N/A	0
Leading Pedestrian Interval	No	-2	No	-2	No	-2	No	-2
<i>CORNER RADIUS</i>								
Parallel Radius	> 10m to 15m	-6	> 15m to 25m	-8	> 10m to 15m	-6	> 10m to 15m	-6
Parallel Right Turn Channel	No Right Turn Channel	-4	Conventional without Receiving	0	No Right Turn Channel	-4	No Right Turn Channel	-4
Perpendicular Radius	N/A	0	N/A	0	N/A	0	> 15m to 25m	-8
Perpendicular Right Turn Channel	N/A	0	N/A	0	N/A	0	Conventional without Receiving	0
<i>CROSSING TREATMENT</i>								
Treatment	Standard	-7	Standard	-7	Standard	-7	Standard	-7
		PETSI SCORE		-43		20		15
		LOS		F		F		F
DELAY SCORE								
Cycle Length		100		100		95		95
Pedestrian Walk Time		7.1		7.1		12.7		12.7
		DELAY SCORE		43.2		35.6		35.6
		LOS		E		D		D
		OVERALL		F		F		F

Table 9: BLOS Intersection Analysis

Approach	Facility Type	Criteria	Travel Lanes and/or Speed	BLOS
Walkley Road/Don Reid Drive/Ryder Street				
North Approach	Mixed Traffic	Right Turn Lane Characteristics	Shared through/right turn lane	A
		Left Turn Accommodation	One lane crossed; 50 km/h	D
South Approach	Mixed Traffic	Right Turn Lane Characteristics	Shared through/right turn lane	A
		Left Turn Accommodation	One lane crossed; ≥ 60 km/h	F
East Approach	Mixed Traffic	Right Turn Lane Characteristics	Shared through/right turn lane	A
		Left Turn Accommodation	Two lanes crossed; ≥ 50 km/h	F
West Approach	Mixed Traffic	Right Turn Lane Characteristics	Shared through/right turn lane	A
		Left Turn Accommodation	Two lanes crossed; ≥ 50 km/h	F
Walkley Road/160m West of Conroy Road				
South Approach	Mixed Traffic	Right Turn Lane Characteristics	Right turn lane < 50 m; turning speed < 25 km/h	D
		Left Turn Accommodation	One lane crossed; ≤ 40 km/h (private approach, low speed assumed)	B
East Approach	Mixed Traffic	Right Turn Lane Characteristics	No right turn	-
		Left Turn Accommodation	Two lanes crossed; ≥ 50 km/h	F
West Approach	Pocket Bike Lane	Right Turn Lane Characteristics	Right turn lane ≤ 50 m, and is introduced to the right	B
		Left Turn Accommodation	No left turn	-
Walkley Road/Conroy Road				
South Approach	Pocket Bike Lane	Right Turn Lane Characteristics	Bike lane shifts to the left; turning speed ≤ 25 km/h	D
		Left Turn Accommodation	Dual left turn lanes	F
East Approach	Mixed Traffic	Right Turn Lane Characteristics	No right turn	-
		Left Turn Accommodation	Dual left turn lanes	F
West Approach	Pocket Bike Lane	Right Turn Lane Characteristics	Right turn lane > 50 m, and is introduced to the right	D
		Left Turn Accommodation	No left turn	-

Approach	Facility Type	Criteria	Travel Lanes and/or Speed	BLOS
St. Laurent Boulevard/Conroy Road				
North Approach	Curbside Bike Lane	Right Turn Lane Characteristics	Shared through/right turn lane	A
		Left Turn Accommodation	Three lanes crossed; ≥ 50 km/h	F
South Approach	Curbside Bike Lane	Right Turn Lane Characteristics	Shared through/right turn lane	A
		Left Turn Accommodation	Three lanes crossed; ≥ 50 km/h	F
East Approach	Mixed Traffic	Right Turn Lane Characteristics	Right turn lane ≤ 50 m; turning speed ≤ 25 km/h	D
		Left Turn Accommodation	One lane crossed; ≥ 60 km/h	F
West Approach	Mixed Traffic	Right Turn Lane Characteristics	Right turn lane < 50 m; turning speed ≤ 25 km/h	D
		Left Turn Accommodation	One lane crossed; ≥ 60 km/h	F

Table 10: TLOS Intersection Analysis

Approach	Delay ⁽¹⁾		TLOS
	AM Peak Hour	PM Peak Hour	
Walkley Road/Don Reid Drive/Ryder Street			
North Approach	30 sec	40 sec	E
East Approach	7 sec	10 sec	B
West Approach	8 sec	13 sec	C
Walkley Road/160m West of Conroy Road			
East Approach	9 sec	8 sec	B
West Approach	3 sec	2 sec	B
Walkley Road/Conroy Road			
South Approach	42 sec	36 sec	F
East Approach	23 sec	28 sec	D
West Approach	23 sec	31 sec	E
St. Laurent Boulevard/Conroy Road			
North Approach	13 sec	28 sec	D
South Approach	11 sec	19 sec	C
East Approach	25 sec	18 sec	D

1. Delay based on outputs from Synchro analysis of existing conditions

Table 11: TkLOS Intersection Analysis

Approach	Effective Corner Radius	Number of Receiving Lanes Departing Intersection	TkLOS
Walkley Road/Don Reid Drive/Ryder Street			
North Approach	10m to 15m	2	B
South Approach	10m to 15m	2	B
East Approach	10m to 15m	1	E
West Approach	10m to 15m	1	E
Walkley Road/160m West of Conroy Road			
South Approach	10m to 15m	2	B
West Approach	10m to 15m	1	E
Walkley Road/Conroy Road			
South Approach	> 15m	3	A
West Approach	> 15m	2	A
St. Laurent Boulevard/Conroy Road			
North Approach	10m to 15m	1	E
South Approach	10m to 15m	1	E
East Approach	10m to 15m	3	B
West Approach	> 15m	2	A

APPENDIX N

Total Synchro Analysis

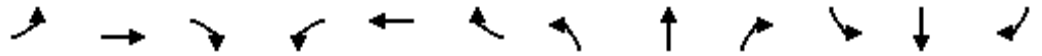

Lane Group	EBL	EBT	EBR	WBL	WBT	WBR	NBL	NBT	NBR	SBL	SBT	SBR
Lane Configurations												
Traffic Volume (vph)	29	925	173	46	1410	195	97	7	60	49	47	39
Future Volume (vph)	29	925	173	46	1410	195	97	7	60	49	47	39
Ideal Flow (vphpl)	1800	1800	1800	1800	1800	1800	1800	1800	1800	1800	1800	1800
Storage Length (m)	40.0		0.0	50.0		0.0	35.0		0.0	30.0		0.0
Storage Lanes	1		0	1		0	1		0	1		0
Taper Length (m)	25.0			30.0			25.0			30.0		
Lane Util. Factor	1.00	0.95	0.95	1.00	0.95	0.95	1.00	1.00	1.00	1.00	1.00	1.00
Ped Bike Factor		0.99		1.00	1.00		1.00	0.98		1.00	0.99	
Frt		0.976			0.982			0.866			0.932	
Flt Protected	0.950			0.950			0.950			0.950		
Satd. Flow (prot)	1537	3169	0	1642	3166	0	1580	1367	0	1674	1630	0
Flt Permitted	0.119			0.237			0.701			0.713		
Satd. Flow (perm)	193	3169	0	408	3166	0	1161	1367	0	1251	1630	0
Right Turn on Red			Yes			Yes			Yes			Yes
Satd. Flow (RTOR)		37			26			60			39	
Link Speed (k/h)		50			50			50			50	
Link Distance (m)		402.0			171.1			100.3			281.0	
Travel Time (s)		28.9			12.3			7.2			20.2	
Confl. Peds. (#/hr)	5		10	10		5	5		5	5		5
Confl. Bikes (#/hr)			3			3			3			
Peak Hour Factor	1.00	1.00	1.00	1.00	1.00	1.00	1.00	1.00	1.00	1.00	1.00	1.00
Heavy Vehicles (%)	10%	4%	1%	3%	5%	1%	7%	1%	12%	1%	1%	1%
Adj. Flow (vph)	29	925	173	46	1410	195	97	7	60	49	47	39
Shared Lane Traffic (%)												
Lane Group Flow (vph)	29	1098	0	46	1605	0	97	67	0	49	86	0
Enter Blocked Intersection	No	No	No	No	No	No	No	No	No	No	No	No
Lane Alignment	L NA	Left	R NA	Left	Left	Right	L NA	Left	R NA	L NA	Left	R NA
Median Width(m)		5.0			5.0			3.5			3.5	
Link Offset(m)		0.0			0.0			0.0			0.0	
Crosswalk Width(m)		5.0			5.0			5.0			5.0	
Two way Left Turn Lane												
Headway Factor	1.09	1.09	1.09	1.09	1.09	1.09	1.09	1.09	1.09	1.09	1.09	1.09
Turning Speed (k/h)	24		14	24		14	24		14	24		14
Number of Detectors	1	2		1	2		1	2		1	2	
Detector Template	Left	Thru		Left	Thru		Left	Thru		Left	Thru	
Leading Detector (m)	6.1	30.5		6.1	30.5		6.1	30.5		6.1	30.5	
Trailing Detector (m)	0.0	0.0		0.0	0.0		0.0	0.0		0.0	0.0	
Detector 1 Position(m)	0.0	0.0		0.0	0.0		0.0	0.0		0.0	0.0	
Detector 1 Size(m)	6.1	1.8		6.1	1.8		6.1	1.8		6.1	1.8	
Detector 1 Type	Cl+Ex	Cl+Ex		Cl+Ex	Cl+Ex		Cl+Ex	Cl+Ex		Cl+Ex	Cl+Ex	
Detector 1 Channel												
Detector 1 Extend (s)	0.0	0.0		0.0	0.0		0.0	0.0		0.0	0.0	
Detector 1 Queue (s)	0.0	0.0		0.0	0.0		0.0	0.0		0.0	0.0	
Detector 1 Delay (s)	0.0	0.0		0.0	0.0		0.0	0.0		0.0	0.0	
Detector 2 Position(m)		28.7			28.7			28.7			28.7	
Detector 2 Size(m)		1.8			1.8			1.8			1.8	
Detector 2 Type		Cl+Ex			Cl+Ex			Cl+Ex			Cl+Ex	
Detector 2 Channel												
Detector 2 Extend (s)		0.0			0.0			0.0			0.0	
Turn Type	Perm	NA		Perm	NA		Perm	NA		Perm	NA	
Protected Phases		2			6			8			4	
Permitted Phases	2			6			8			4		
Detector Phase	2	2		6	6		8	8		4	4	



Lane Group	EBT	EBR	WBL	WBT	NBL	NBR
Lane Configurations	↑↑	↗	↖	↑↑	↖	↗
Traffic Volume (vph)	954	90	74	1595	66	60
Future Volume (vph)	954	90	74	1595	66	60
Ideal Flow (vphpl)	1800	1800	1800	1800	1800	1800
Storage Length (m)		20.0	65.0		30.0	0.0
Storage Lanes		1	1		1	1
Taper Length (m)			25.0		30.0	
Lane Util. Factor	0.95	1.00	1.00	0.95	1.00	1.00
Ped Bike Factor		0.96	1.00		0.99	0.98
Fr _t		0.850				0.850
Fl _t Protected			0.950		0.950	
Satd. Flow (prot)	3221	1498	1674	3191	1674	1483
Fl _t Permitted			0.290		0.950	
Satd. Flow (perm)	3221	1442	509	3191	1663	1456
Right Turn on Red		Yes				Yes
Satd. Flow (RTOR)		71				60
Link Speed (k/h)	50			50	50	
Link Distance (m)	171.1			169.1	128.6	
Travel Time (s)	12.3			12.2	9.3	
Confl. Peds. (#/hr)		10	10		5	5
Confl. Bikes (#/hr)		3				
Peak Hour Factor	1.00	1.00	1.00	1.00	1.00	1.00
Heavy Vehicles (%)	5%	1%	1%	6%	1%	2%
Adj. Flow (vph)	954	90	74	1595	66	60
Shared Lane Traffic (%)						
Lane Group Flow (vph)	954	90	74	1595	66	60
Enter Blocked Intersection	No	No	No	No	No	No
Lane Alignment	Left	Right	L NA	Left	L NA	R NA
Median Width(m)	3.5			5.0	3.5	
Link Offset(m)	0.0			0.0	0.0	
Crosswalk Width(m)	5.0			5.0	5.0	
Two way Left Turn Lane						
Headway Factor	1.09	1.09	1.09	1.09	1.09	1.09
Turning Speed (k/h)		14	24		24	14
Number of Detectors	2	1	1	2	1	1
Detector Template	Thru	Right	Left	Thru	Left	Right
Leading Detector (m)	30.5	6.1	6.1	30.5	6.1	6.1
Trailing Detector (m)	0.0	0.0	0.0	0.0	0.0	0.0
Detector 1 Position(m)	0.0	0.0	0.0	0.0	0.0	0.0
Detector 1 Size(m)	1.8	6.1	6.1	1.8	6.1	6.1
Detector 1 Type	Cl+Ex	Cl+Ex	Cl+Ex	Cl+Ex	Cl+Ex	Cl+Ex
Detector 1 Channel						
Detector 1 Extend (s)	0.0	0.0	0.0	0.0	0.0	0.0
Detector 1 Queue (s)	0.0	0.0	0.0	0.0	0.0	0.0
Detector 1 Delay (s)	0.0	0.0	0.0	0.0	0.0	0.0
Detector 2 Position(m)	28.7			28.7		
Detector 2 Size(m)	1.8			1.8		
Detector 2 Type	Cl+Ex			Cl+Ex		
Detector 2 Channel						
Detector 2 Extend (s)	0.0			0.0		
Turn Type	NA	Perm	Perm	NA	Prot	Perm
Protected Phases	2			6	8	
Permitted Phases		2	6			8
Detector Phase	2	2	6	6	8	8

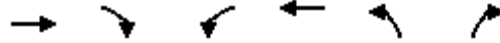

Lane Group	EBT	EBR	WBL	WBT	NBL	NBR
Switch Phase						
Minimum Initial (s)	10.0	10.0	10.0	10.0	5.0	5.0
Minimum Split (s)	37.0	37.0	37.0	37.0	29.0	29.0
Total Split (s)	71.0	71.0	71.0	71.0	29.0	29.0
Total Split (%)	71.0%	71.0%	71.0%	71.0%	29.0%	29.0%
Maximum Green (s)	65.0	65.0	65.0	65.0	23.0	23.0
Yellow Time (s)	3.3	3.3	3.3	3.3	3.3	3.3
All-Red Time (s)	2.7	2.7	2.7	2.7	2.7	2.7
Lost Time Adjust (s)	0.0	0.0	0.0	0.0	0.0	0.0
Total Lost Time (s)	6.0	6.0	6.0	6.0	6.0	6.0
Lead/Lag						
Lead-Lag Optimize?						
Vehicle Extension (s)	3.0	3.0	3.0	3.0	3.0	3.0
Recall Mode	C-Max	C-Max	C-Max	C-Max	None	None
Walk Time (s)	18.0	18.0			7.0	7.0
Flash Dont Walk (s)	13.0	13.0			16.0	16.0
Pedestrian Calls (#/hr)	5	5			5	5
Act Effct Green (s)	80.2	80.2	80.2	80.2	11.3	11.3
Actuated g/C Ratio	0.80	0.80	0.80	0.80	0.11	0.11
v/c Ratio	0.37	0.08	0.18	0.62	0.35	0.28
Control Delay	3.0	0.9	5.9	7.6	43.6	12.6
Queue Delay	0.0	0.0	0.0	0.4	0.0	0.0
Total Delay	3.0	0.9	5.9	8.0	43.6	12.6
LOS	A	A	A	A	D	B
Approach Delay	2.8			7.9	28.8	
Approach LOS	A			A	C	
Queue Length 50th (m)	14.8	0.2	2.6	50.0	11.3	0.0
Queue Length 95th (m)	21.8	0.9	11.2	121.1	19.6	8.9
Internal Link Dist (m)	147.1			145.1	104.6	
Turn Bay Length (m)		20.0	65.0		30.0	
Base Capacity (vph)	2583	1170	408	2560	385	381
Starvation Cap Reductn	0	0	0	443	0	0
Spillback Cap Reductn	0	0	0	26	0	0
Storage Cap Reductn	0	0	0	0	0	0
Reduced v/c Ratio	0.37	0.08	0.18	0.75	0.17	0.16

Intersection Summary

Area Type:	Other
Cycle Length:	100
Actuated Cycle Length:	100
Offset:	88 (88%), Referenced to phase 2:EBT and 6:WBTL, Start of Green
Natural Cycle:	75
Control Type:	Actuated-Coordinated
Maximum v/c Ratio:	0.62
Intersection Signal Delay:	6.9
Intersection LOS:	A
Intersection Capacity Utilization:	63.0%
ICU Level of Service:	B
Analysis Period (min):	15

Splits and Phases: 2: 160m W of Conroy & Walkley



	→	↘	↙	←	↖	↗	↘
Lane Group	EBT	EBR	WBL	WBT	NBU	NBL	NBR
Lane Configurations	↑↑	↗	↘↘	↑↑		↘↘	↗
Traffic Volume (vph)	801	267	250	996	14	683	471
Future Volume (vph)	801	267	250	996	14	683	471
Ideal Flow (vphpl)	1800	1800	1800	1800	1800	1800	1800
Storage Length (m)		75.0	200.0			0.0	0.0
Storage Lanes		1	2			2	1
Taper Length (m)			50.0			10.0	
Lane Util. Factor	0.95	1.00	0.97	0.95	0.95	0.97	1.00
Ped Bike Factor		0.97	0.99				0.98
Frt		0.850					0.850
Flt Protected			0.950			0.950	
Satd. Flow (prot)	3161	1455	3066	3161	0	3186	1455
Flt Permitted			0.950			0.950	
Satd. Flow (perm)	3161	1409	3036	3161	0	3186	1423
Right Turn on Red		Yes					Yes
Satd. Flow (RTOR)		267					355
Link Speed (k/h)	50			50		60	
Link Distance (m)	169.1			271.7		348.5	
Travel Time (s)	12.2			19.6		20.9	
Confl. Peds. (#/hr)		15	15				5
Confl. Bikes (#/hr)		3					3
Peak Hour Factor	1.00	1.00	1.00	1.00	1.00	1.00	1.00
Heavy Vehicles (%)	7%	4%	7%	7%	2%	3%	4%
Adj. Flow (vph)	801	267	250	996	14	683	471
Shared Lane Traffic (%)							
Lane Group Flow (vph)	801	267	250	996	0	697	471
Enter Blocked Intersection	No	No	No	No	No	No	No
Lane Alignment	Left	R NA	Left	Left	R NA	L NA	R NA
Median Width(m)	7.0			9.0		10.5	
Link Offset(m)	0.0			0.0		0.0	
Crosswalk Width(m)	5.0			5.0		5.0	
Two way Left Turn Lane							
Headway Factor	1.09	1.09	1.09	1.09	1.09	1.09	1.09
Turning Speed (k/h)		14	24		14	24	14
Number of Detectors	2	1	1	2	1	1	1
Detector Template	Thru	Right	Left	Thru	Left	Left	Right
Leading Detector (m)	30.5	6.1	6.1	30.5	6.1	6.1	6.1
Trailing Detector (m)	0.0	0.0	0.0	0.0	0.0	0.0	0.0
Detector 1 Position(m)	0.0	0.0	0.0	0.0	0.0	0.0	0.0
Detector 1 Size(m)	1.8	6.1	6.1	1.8	6.1	6.1	6.1
Detector 1 Type	Cl+Ex	Cl+Ex	Cl+Ex	Cl+Ex	Cl+Ex	Cl+Ex	Cl+Ex
Detector 1 Channel							
Detector 1 Extend (s)	0.0	0.0	0.0	0.0	0.0	0.0	0.0
Detector 1 Queue (s)	0.0	0.0	0.0	0.0	0.0	0.0	0.0
Detector 1 Delay (s)	0.0	0.0	0.0	0.0	0.0	0.0	0.0
Detector 2 Position(m)	28.7			28.7			
Detector 2 Size(m)	1.8			1.8			
Detector 2 Type	Cl+Ex			Cl+Ex			
Detector 2 Channel							
Detector 2 Extend (s)	0.0			0.0			
Turn Type	NA	Perm	Prot	NA	Perm	Prot	Perm
Protected Phases	2		1	6		8	
Permitted Phases		2			8		8
Detector Phase	2	2	1	6	8	8	8

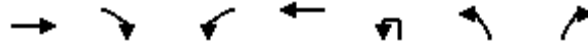

Lane Group	EBT	EBR	WBL	WBT	NBU	NBL	NBR
Switch Phase							
Minimum Initial (s)	10.0	10.0	5.0	10.0	5.0	5.0	5.0
Minimum Split (s)	36.4	36.4	16.0	24.7	30.4	30.4	30.4
Total Split (s)	55.0	55.0	25.0	80.0	40.0	40.0	40.0
Total Split (%)	45.8%	45.8%	20.8%	66.7%	33.3%	33.3%	33.3%
Maximum Green (s)	48.6	48.6	18.8	73.6	33.6	33.6	33.6
Yellow Time (s)	3.7	3.7	3.3	3.7	3.7	3.7	3.7
All-Red Time (s)	2.7	2.7	2.9	2.7	2.7	2.7	2.7
Lost Time Adjust (s)	0.0	0.0	0.0	0.0		0.0	0.0
Total Lost Time (s)	6.4	6.4	6.2	6.4		6.4	6.4
Lead/Lag	Lag	Lag	Lead				
Lead-Lag Optimize?	Yes	Yes	Yes				
Vehicle Extension (s)	3.0	3.0	3.0	3.0	3.0	3.0	3.0
Recall Mode	C-Max	C-Max	None	C-Max	None	None	None
Walk Time (s)	10.0	10.0			7.0	7.0	7.0
Flash Dont Walk (s)	20.0	20.0			17.0	17.0	17.0
Pedestrian Calls (#/hr)	10	10			5	5	5
Act Effct Green (s)	55.0	55.0	14.9	76.1		31.1	31.1
Actuated g/C Ratio	0.46	0.46	0.12	0.63		0.26	0.26
v/c Ratio	0.55	0.34	0.66	0.50		0.84	0.75
Control Delay	26.5	3.9	58.3	13.2		52.4	17.9
Queue Delay	0.0	0.0	0.0	0.0		0.0	0.0
Total Delay	26.5	3.9	58.3	13.2		52.4	17.9
LOS	C	A	E	B		D	B
Approach Delay	20.8			22.2		38.5	
Approach LOS	C			C		D	
Queue Length 50th (m)	66.6	0.0	27.0	58.8		72.6	21.3
Queue Length 95th (m)	90.9	14.6	38.0	75.0		92.2	59.1
Internal Link Dist (m)	145.1			247.7		324.5	
Turn Bay Length (m)		75.0	200.0				
Base Capacity (vph)	1448	790	480	2004		892	654
Starvation Cap Reductn	0	0	0	0		0	0
Spillback Cap Reductn	0	0	0	0		0	0
Storage Cap Reductn	0	0	0	0		0	0
Reduced v/c Ratio	0.55	0.34	0.52	0.50		0.78	0.72

Intersection Summary

























Area Type: Other
 Cycle Length: 120
 Actuated Cycle Length: 120
 Offset: 43 (36%), Referenced to phase 2:EBT and 6:WBT, Start of Green
 Natural Cycle: 85
 Control Type: Actuated-Coordinated
 Maximum v/c Ratio: 0.84
 Intersection Signal Delay: 27.3
 Intersection LOS: C
 Intersection Capacity Utilization 69.4%
 ICU Level of Service C
 Analysis Period (min) 15

Splits and Phases: 3: Conroy & Walkley



4: Conroy & St. Laurent
AM Peak Hour

2510 St. Laurent Boulevard
2024 Total Traffic

													
Lane Group	EBL	EBT	EBR	WBL	WBT	WBR	NBL	NBT	NBR	SBL	SBT	SBR	
Lane Configurations													
Traffic Volume (vph)	15	69	88	63	46	25	195	1187	199	87	370	57	
Future Volume (vph)	15	69	88	63	46	25	195	1187	199	87	370	57	
Ideal Flow (vphpl)	1800	1800	1800	1800	1800	1800	1800	1800	1800	1800	1800	1800	
Storage Length (m)	45.0		50.0	55.0		55.0	0.0		0.0	110.0		0.0	
Storage Lanes	1		1	1		1	1		0	1		0	
Taper Length (m)	40.0			40.0			10.0			25.0			
Lane Util. Factor	1.00	1.00	1.00	1.00	1.00	1.00	1.00	0.91	0.91	1.00	0.95	0.95	
Ped Bike Factor	0.99		0.97	0.99		0.98	0.98	0.99		0.99	0.99		
Fr _t			0.850			0.850		0.978			0.980		
Fl _t Protected	0.950			0.950			0.950			0.950			
Satd. Flow (prot)	1353	1695	1427	1409	1589	1351	1642	4610	0	1674	3157	0	
Fl _t Permitted	0.727			0.712			0.503			0.166			
Satd. Flow (perm)	1027	1695	1391	1044	1589	1322	850	4610	0	291	3157	0	
Right Turn on Red			Yes			Yes			Yes			Yes	
Satd. Flow (RTOR)			88			36							
Link Speed (k/h)		50			50			60			60		
Link Distance (m)		197.7			271.8			372.7			348.5		
Travel Time (s)		14.2			19.6			22.4			20.9		
Confl. Peds. (#/hr)	10		15	15		10	20		25	25		20	
Confl. Bikes (#/hr)			3			3			3			25	
Peak Hour Factor	1.00	1.00	1.00	1.00	1.00	1.00	1.00	1.00	1.00	1.00	1.00	1.00	
Heavy Vehicles (%)	25%	5%	6%	20%	12%	12%	3%	2%	2%	1%	4%	3%	
Adj. Flow (vph)	15	69	88	63	46	25	195	1187	199	87	370	57	
Shared Lane Traffic (%)													
Lane Group Flow (vph)	15	69	88	63	46	25	195	1386	0	87	427	0	
Enter Blocked Intersection	No	No	No	No	No	No	No	No	No	No	No	No	
Lane Alignment	L NA	Left	R NA	L NA	Left	R NA	Left	Left	Right	L NA	Left	R NA	
Median Width(m)		3.5			3.5			7.0			6.0		
Link Offset(m)		0.0			0.0			0.0			0.0		
Crosswalk Width(m)		5.0			5.0			5.0			5.0		
Two way Left Turn Lane													
Headway Factor	1.09	1.09	1.09	1.09	1.09	1.09	1.09	1.09	1.09	1.09	1.09	1.09	
Turning Speed (k/h)	24		14	24		14	24		14	24		14	
Number of Detectors	1	2	1	1	2	1	1	2		1	2		
Detector Template	Left	Thru	Right	Left	Thru	Right	Left	Thru		Left	Thru		
Leading Detector (m)	6.1	30.5	6.1	6.1	30.5	6.1	6.1	30.5		6.1	30.5		
Trailing Detector (m)	0.0	0.0	0.0	0.0	0.0	0.0	0.0	0.0		0.0	0.0		
Detector 1 Position(m)	0.0	0.0	0.0	0.0	0.0	0.0	0.0	0.0		0.0	0.0		
Detector 1 Size(m)	6.1	1.8	6.1	6.1	1.8	6.1	6.1	1.8		6.1	1.8		
Detector 1 Type	Cl+Ex	Cl+Ex	Cl+Ex	Cl+Ex	Cl+Ex	Cl+Ex	Cl+Ex	Cl+Ex		Cl+Ex	Cl+Ex		
Detector 1 Channel													
Detector 1 Extend (s)	0.0	0.0	0.0	0.0	0.0	0.0	0.0	0.0		0.0	0.0		
Detector 1 Queue (s)	0.0	0.0	0.0	0.0	0.0	0.0	0.0	0.0		0.0	0.0		
Detector 1 Delay (s)	0.0	0.0	0.0	0.0	0.0	0.0	0.0	0.0		0.0	0.0		
Detector 2 Position(m)		28.7			28.7			28.7			28.7		
Detector 2 Size(m)		1.8			1.8			1.8			1.8		
Detector 2 Type		Cl+Ex			Cl+Ex			Cl+Ex			Cl+Ex		
Detector 2 Channel													
Detector 2 Extend (s)		0.0			0.0			0.0			0.0		
Turn Type	Perm	NA	Perm	Perm	NA	Perm	Perm	NA		Perm	NA		
Protected Phases		4			8			2			6		
Permitted Phases	4		4	8		8	2			6			
Detector Phase	4	4	4	8	8	8	2	2		6	6		

4: Conroy & St. Laurent
AM Peak Hour

2510 St. Laurent Boulevard
2024 Total Traffic

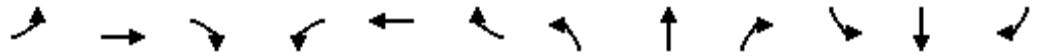

Lane Group	EBL	EBT	EBR	WBL	WBT	WBR	NBL	NBT	NBR	SBL	SBT	SBR
Switch Phase												
Minimum Initial (s)	10.0	10.0	10.0	10.0	10.0	10.0	10.0	10.0		10.0	10.0	
Minimum Split (s)	43.9	43.9	43.9	43.9	43.9	43.9	30.3	30.3		30.3	30.3	
Total Split (s)	44.0	44.0	44.0	44.0	44.0	44.0	56.0	56.0		56.0	56.0	
Total Split (%)	44.0%	44.0%	44.0%	44.0%	44.0%	44.0%	56.0%	56.0%		56.0%	56.0%	
Maximum Green (s)	37.1	37.1	37.1	37.1	37.1	37.1	49.7	49.7		49.7	49.7	
Yellow Time (s)	3.3	3.3	3.3	3.3	3.3	3.3	3.7	3.7		3.7	3.7	
All-Red Time (s)	3.6	3.6	3.6	3.6	3.6	3.6	2.6	2.6		2.6	2.6	
Lost Time Adjust (s)	0.0	0.0	0.0	0.0	0.0	0.0	0.0	0.0		0.0	0.0	
Total Lost Time (s)	6.9	6.9	6.9	6.9	6.9	6.9	6.3	6.3		6.3	6.3	
Lead/Lag												
Lead-Lag Optimize?												
Vehicle Extension (s)	3.0	3.0	3.0	3.0	3.0	3.0	3.0	3.0		3.0	3.0	
Recall Mode	None	None	None	None	None	None	C-Max	C-Max		C-Max	C-Max	
Walk Time (s)	7.0	7.0	7.0	7.0	7.0	7.0	7.0	7.0		7.0	7.0	
Flash Dont Walk (s)	30.0	30.0	30.0	30.0	30.0	30.0	17.0	17.0		17.0	17.0	
Pedestrian Calls (#/hr)	15	15	15	10	10	10	20	20		15	15	
Act Effct Green (s)	21.1	21.1	21.1	21.1	21.1	21.1	70.4	70.4		70.4	70.4	
Actuated g/C Ratio	0.21	0.21	0.21	0.21	0.21	0.21	0.70	0.70		0.70	0.70	
v/c Ratio	0.07	0.19	0.24	0.29	0.14	0.08	0.33	0.43		0.43	0.19	
Control Delay	24.3	28.7	7.4	31.8	27.7	5.2	13.1	10.4		23.6	8.6	
Queue Delay	0.0	0.0	0.0	0.0	0.0	0.0	0.0	0.0		0.0	0.0	
Total Delay	24.3	28.7	7.4	31.8	27.7	5.2	13.1	10.4		23.6	8.6	
LOS	C	C	A	C	C	A	B	B		C	A	
Approach Delay		17.4			25.5			10.7			11.1	
Approach LOS		B			C			B			B	
Queue Length 50th (m)	2.5	11.7	1.7	10.8	7.6	0.0	9.2	25.0		4.5	8.7	
Queue Length 95th (m)	m5.2	17.2	9.9	16.1	12.1	3.5	39.9	73.0		#33.1	29.8	
Internal Link Dist (m)		173.7			247.8			348.7			324.5	
Turn Bay Length (m)	45.0		50.0	55.0		55.0				110.0		
Base Capacity (vph)	381	628	571	387	589	513	598	3257		204	2228	
Starvation Cap Reductn	0	0	0	0	0	0	0	0		0	0	
Spillback Cap Reductn	0	0	0	0	0	0	0	0		0	0	
Storage Cap Reductn	0	0	0	0	0	0	0	0		0	0	
Reduced v/c Ratio	0.04	0.11	0.15	0.16	0.08	0.05	0.33	0.43		0.43	0.19	

Intersection Summary

Area Type: Other
 Cycle Length: 100
 Actuated Cycle Length: 100
 Offset: 23 (23%), Referenced to phase 2:NBT and 6:SBTL, Start of Green
 Natural Cycle: 90
 Control Type: Actuated-Coordinated
 Maximum v/c Ratio: 0.43
 Intersection Signal Delay: 12.1 Intersection LOS: B
 Intersection Capacity Utilization 71.0% ICU Level of Service C
 Analysis Period (min) 15
 # 95th percentile volume exceeds capacity, queue may be longer.
 Queue shown is maximum after two cycles.
 m Volume for 95th percentile queue is metered by upstream signal.

Splits and Phases: 4: Conroy & St. Laurent

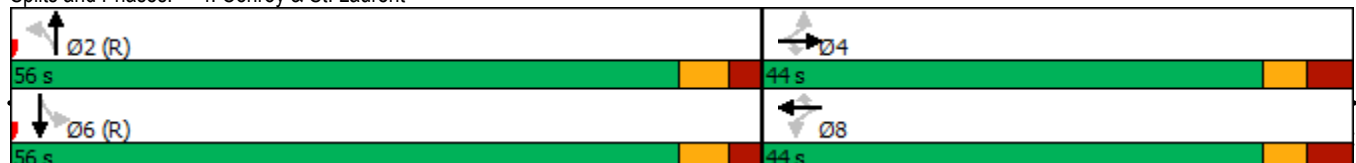



Lane Group	WBL	WBR	NBT	NBR	SBL	SBT
Lane Configurations						
Traffic Volume (vph)	75	59	71	22	101	176
Future Volume (vph)	75	59	71	22	101	176
Ideal Flow (vphpl)	1800	1800	1800	1800	1800	1800
Lane Util. Factor	1.00	1.00	1.00	1.00	1.00	1.00
Ped Bike Factor						
Frt	0.941		0.968			
Flt Protected	0.973					0.982
Satd. Flow (prot)	1547	0	1498	0	0	1669
Flt Permitted	0.973					0.982
Satd. Flow (perm)	1547	0	1498	0	0	1669
Link Speed (k/h)	50		50			50
Link Distance (m)	137.6		234.0			146.3
Travel Time (s)	9.9		16.8			10.5
Confl. Peds. (#/hr)				10	10	
Confl. Bikes (#/hr)		4		3		
Peak Hour Factor	1.00	1.00	1.00	1.00	1.00	1.00
Heavy Vehicles (%)	4%	7%	15%	15%	6%	4%
Adj. Flow (vph)	75	59	71	22	101	176
Shared Lane Traffic (%)						
Lane Group Flow (vph)	134	0	93	0	0	277
Enter Blocked Intersection	No	No	No	No	No	No
Lane Alignment	Left	Right	Left	Right	Left	Left
Median Width(m)	3.5		0.0			0.0
Link Offset(m)	0.0		0.0			0.0
Crosswalk Width(m)	2.0		10.0			10.0
Two way Left Turn Lane						
Headway Factor	1.09	1.09	1.09	1.09	1.09	1.09
Turning Speed (k/h)	24	14		14	24	
Sign Control	Stop		Free			Free

Intersection Summary

Area Type: Other

Control Type: Unsignalized

Intersection Capacity Utilization 37.2%

ICU Level of Service A

Analysis Period (min) 15



Lane Group	EBL	EBT	WBT	WBR	SBL	SBR
Lane Configurations						
Traffic Volume (vph)	0	128	135	5	13	0
Future Volume (vph)	0	128	135	5	13	0
Ideal Flow (vphpl)	1800	1800	1800	1800	1800	1800
Lane Util. Factor	1.00	1.00	1.00	1.00	1.00	1.00
Ped Bike Factor						
Frt	0.995					
Flt Protected					0.950	
Satd. Flow (prot)	0	1618	1615	0	1674	0
Flt Permitted					0.950	
Satd. Flow (perm)	0	1618	1615	0	1674	0
Link Speed (k/h)	50		50	50		
Link Distance (m)	40.4		197.7	90.8		
Travel Time (s)	2.9		14.2	6.5		
Confl. Peds. (#/hr)	10				10	
Confl. Bikes (#/hr)				3	3	
Peak Hour Factor	1.00	1.00	1.00	1.00	1.00	1.00
Heavy Vehicles (%)	1%	10%	10%	1%	1%	1%
Adj. Flow (vph)	0	128	135	5	13	0
Shared Lane Traffic (%)						
Lane Group Flow (vph)	0	128	140	0	13	0
Enter Blocked Intersection	No	No	No	No	No	No
Lane Alignment	Left	Left	Left	Right	Left	Right
Median Width(m)	0.0		3.5	3.5		
Link Offset(m)	0.0		0.0	0.0		
Crosswalk Width(m)	0.0		0.0	5.0		
Two way Left Turn Lane						
Headway Factor	1.09	1.09	1.09	1.09	1.09	1.09
Turning Speed (k/h)	24				14	24
Sign Control	Free		Free	Stop		

Intersection Summary

Area Type: Other

Control Type: Unsignalized

Intersection Capacity Utilization 19.4% ICU Level of Service A

Analysis Period (min) 15



Lane Group	EBL	EBT	WBT	WBR	SBL	SBR
Lane Configurations						
Traffic Volume (vph)	0	123	133	2	5	1
Future Volume (vph)	0	123	133	2	5	1
Ideal Flow (vphpl)	1800	1800	1800	1800	1800	1800
Lane Util. Factor	1.00	1.00	1.00	1.00	1.00	1.00
Ped Bike Factor						
Frts			0.998		0.977	
Flt Protected					0.960	
Satd. Flow (prot)	0	1618	1617	0	1653	0
Flt Permitted					0.960	
Satd. Flow (perm)	0	1618	1617	0	1653	0
Link Speed (k/h)		50	50		50	
Link Distance (m)		137.6	40.4		92.1	
Travel Time (s)		9.9	2.9		6.6	
Confl. Peds. (#/hr)	10			10		
Confl. Bikes (#/hr)				3		3
Peak Hour Factor	1.00	1.00	1.00	1.00	1.00	1.00
Heavy Vehicles (%)	1%	10%	10%	1%	1%	1%
Adj. Flow (vph)	0	123	133	2	5	1
Shared Lane Traffic (%)						
Lane Group Flow (vph)	0	123	135	0	6	0
Enter Blocked Intersection	No	No	No	No	No	No
Lane Alignment	Left	Left	Left	Right	Left	Right
Median Width(m)		0.0	0.0		3.5	
Link Offset(m)		0.0	0.0		0.0	
Crosswalk Width(m)		0.0	0.0		5.0	
Two way Left Turn Lane						
Headway Factor	1.09	1.09	1.09	1.09	1.09	1.09
Turning Speed (k/h)	24			14	24	14
Sign Control		Free	Free		Stop	

Intersection Summary

Area Type:	Other
Control Type:	Unsignalized
Intersection Capacity Utilization	19.2%
ICU Level of Service	A
Analysis Period (min)	15



Lane Group	WBL	WBR	NBT	NBR	SBL	SBT
Lane Configurations						
Traffic Volume (vph)	1	15	139	0	6	252
Future Volume (vph)	1	15	139	0	6	252
Ideal Flow (vphpl)	1800	1800	1800	1800	1800	1800
Lane Util. Factor	1.00	1.00	1.00	1.00	1.00	1.00
Ped Bike Factor						
Frt	0.873					
Flt Protected	0.997					0.999
Satd. Flow (prot)	1534	0	1618	0	0	1695
Flt Permitted	0.997					0.999
Satd. Flow (perm)	1534	0	1618	0	0	1695
Link Speed (k/h)	50		50		50	
Link Distance (m)	105.3		30.4		100.3	
Travel Time (s)	7.6		2.2		7.2	
Confl. Peds. (#/hr)				10	10	
Confl. Bikes (#/hr)	3			3		
Peak Hour Factor	1.00	1.00	1.00	1.00	1.00	1.00
Heavy Vehicles (%)	1%	1%	10%	1%	1%	5%
Adj. Flow (vph)	1	15	139	0	6	252
Shared Lane Traffic (%)						
Lane Group Flow (vph)	16	0	139	0	0	258
Enter Blocked Intersection	No	No	No	No	No	No
Lane Alignment	Left	Right	Left	Right	Left	Left
Median Width(m)	3.5		3.5		3.5	
Link Offset(m)	0.0		0.0		0.0	
Crosswalk Width(m)	5.0		0.0		0.0	
Two way Left Turn Lane						
Headway Factor	1.09	1.09	1.09	1.09	1.09	1.09
Turning Speed (k/h)	24	14		14	24	
Sign Control	Stop		Free		Free	

Intersection Summary

Area Type: Other

Control Type: Unsignalized

Intersection Capacity Utilization 29.1% ICU Level of Service A

Analysis Period (min) 15

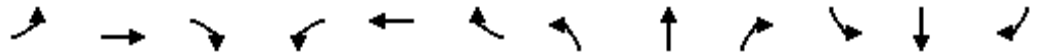

Lane Group	EBL	EBT	EBR	WBL	WBT	WBR	NBL	NBT	NBR	SBL	SBT	SBR
Lane Configurations												
Traffic Volume (vph)	27	1405	119	27	1424	70	177	5	78	92	104	50
Future Volume (vph)	27	1405	119	27	1424	70	177	5	78	92	104	50
Ideal Flow (vphpl)	1800	1800	1800	1800	1800	1800	1800	1800	1800	1800	1800	1800
Storage Length (m)	40.0		0.0	50.0		0.0	35.0		0.0	30.0		0.0
Storage Lanes	1		0	1		0	1		0	1		0
Taper Length (m)	25.0			30.0			25.0			30.0		
Lane Util. Factor	1.00	0.95	0.95	1.00	0.95	0.95	1.00	1.00	1.00	1.00	1.00	1.00
Ped Bike Factor	1.00	1.00		1.00	1.00		1.00	0.98		1.00	0.99	
Fr _t		0.988			0.993			0.859			0.951	
Fl _t Protected	0.950			0.950			0.950			0.950		
Satd. Flow (prot)	1674	3229	0	1674	3289	0	1674	1472	0	1674	1651	0
Fl _t Permitted	0.126			0.121			0.600			0.703		
Satd. Flow (perm)	222	3229	0	213	3289	0	1053	1472	0	1233	1651	0
Right Turn on Red			Yes			Yes			Yes			Yes
Satd. Flow (RTOR)		15			8			48			22	
Link Speed (k/h)		50			50			50			50	
Link Distance (m)		402.0			171.1			100.3			281.0	
Travel Time (s)		28.9			12.3			7.2			20.2	
Confl. Peds. (#/hr)	5		20	20		5	5		5	5		5
Confl. Bikes (#/hr)			5			3			3			
Peak Hour Factor	1.00	1.00	1.00	1.00	1.00	1.00	1.00	1.00	1.00	1.00	1.00	1.00
Heavy Vehicles (%)	1%	3%	3%	1%	2%	1%	1%	1%	2%	1%	1%	4%
Adj. Flow (vph)	27	1405	119	27	1424	70	177	5	78	92	104	50
Shared Lane Traffic (%)												
Lane Group Flow (vph)	27	1524	0	27	1494	0	177	83	0	92	154	0
Enter Blocked Intersection	No	No	No	No	No	No	No	No	No	No	No	No
Lane Alignment	L NA	Left	R NA	Left	Left	Right	L NA	Left	R NA	L NA	Left	R NA
Median Width(m)		5.0			5.0			3.5			3.5	
Link Offset(m)		0.0			0.0			0.0			0.0	
Crosswalk Width(m)		5.0			5.0			5.0			5.0	
Two way Left Turn Lane												
Headway Factor	1.09	1.09	1.09	1.09	1.09	1.09	1.09	1.09	1.09	1.09	1.09	1.09
Turning Speed (k/h)	24		14	24		14	24		14	24		14
Number of Detectors	1	2		1	2		1	2		1	2	
Detector Template	Left	Thru		Left	Thru		Left	Thru		Left	Thru	
Leading Detector (m)	6.1	30.5		6.1	30.5		6.1	30.5		6.1	30.5	
Trailing Detector (m)	0.0	0.0		0.0	0.0		0.0	0.0		0.0	0.0	
Detector 1 Position(m)	0.0	0.0		0.0	0.0		0.0	0.0		0.0	0.0	
Detector 1 Size(m)	6.1	1.8		6.1	1.8		6.1	1.8		6.1	1.8	
Detector 1 Type	Cl+Ex	Cl+Ex		Cl+Ex	Cl+Ex		Cl+Ex	Cl+Ex		Cl+Ex	Cl+Ex	
Detector 1 Channel												
Detector 1 Extend (s)	0.0	0.0		0.0	0.0		0.0	0.0		0.0	0.0	
Detector 1 Queue (s)	0.0	0.0		0.0	0.0		0.0	0.0		0.0	0.0	
Detector 1 Delay (s)	0.0	0.0		0.0	0.0		0.0	0.0		0.0	0.0	
Detector 2 Position(m)		28.7			28.7			28.7			28.7	
Detector 2 Size(m)		1.8			1.8			1.8			1.8	
Detector 2 Type		Cl+Ex			Cl+Ex			Cl+Ex			Cl+Ex	
Detector 2 Channel												
Detector 2 Extend (s)		0.0			0.0			0.0			0.0	
Turn Type	Perm	NA		Perm	NA		Perm	NA		Perm	NA	
Protected Phases		2			6			8			4	
Permitted Phases	2			6			8			4		
Detector Phase	2	2		6	6		8	8		4	4	

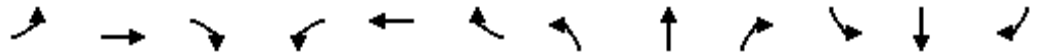

Lane Group	EBL	EBT	EBR	WBL	WBT	WBR	NBL	NBT	NBR	SBL	SBT	SBR
Switch Phase												
Minimum Initial (s)	10.0	10.0		10.0	10.0		10.0	10.0		10.0	10.0	
Minimum Split (s)	35.9	35.9		35.9	35.9		36.2	36.2		36.2	36.2	
Total Split (s)	74.0	74.0		74.0	74.0		36.0	36.0		36.0	36.0	
Total Split (%)	67.3%	67.3%		67.3%	67.3%		32.7%	32.7%		32.7%	32.7%	
Maximum Green (s)	68.1	68.1		68.1	68.1		29.8	29.8		29.8	29.8	
Yellow Time (s)	3.3	3.3		3.3	3.3		3.3	3.3		3.3	3.3	
All-Red Time (s)	2.6	2.6		2.6	2.6		2.9	2.9		2.9	2.9	
Lost Time Adjust (s)	0.0	0.0		0.0	0.0		0.0	0.0		0.0	0.0	
Total Lost Time (s)	5.9	5.9		5.9	5.9		6.2	6.2		6.2	6.2	
Lead/Lag												
Lead-Lag Optimize?												
Vehicle Extension (s)	3.0	3.0		3.0	3.0		3.0	3.0		3.0	3.0	
Recall Mode	C-Max	C-Max		C-Max	C-Max		None	None		None	None	
Walk Time (s)	15.0	15.0		15.0	15.0		10.0	10.0		10.0	10.0	
Flash Dont Walk (s)	15.0	15.0		15.0	15.0		20.0	20.0		20.0	20.0	
Pedestrian Calls (#/hr)	10	10		5	5		5	5		5	5	
Act Effct Green (s)	75.6	75.6		75.6	75.6		22.3	22.3		22.3	22.3	
Actuated g/C Ratio	0.69	0.69		0.69	0.69		0.20	0.20		0.20	0.20	
v/c Ratio	0.18	0.69		0.18	0.66		0.83	0.25		0.37	0.44	
Control Delay	11.6	13.2		9.8	11.3		71.0	18.1		40.2	35.1	
Queue Delay	0.0	0.0		0.0	0.0		0.0	0.0		0.0	0.0	
Total Delay	11.6	13.2		9.8	11.3		71.0	18.1		40.2	35.1	
LOS	B	B		A	B		E	B		D	D	
Approach Delay		13.2			11.3			54.1			37.0	
Approach LOS		B			B			D			D	
Queue Length 50th (m)	1.7	84.6		1.9	122.0		33.5	5.7		15.7	22.7	
Queue Length 95th (m)	6.9	130.9		m2.9	49.9		52.9	16.2		27.3	37.3	
Internal Link Dist (m)		378.0			147.1			76.3			257.0	
Turn Bay Length (m)	40.0			50.0			35.0			30.0		
Base Capacity (vph)	152	2223		146	2263		285	433		334	463	
Starvation Cap Reductn	0	0		0	4		0	0		0	0	
Spillback Cap Reductn	0	0		0	0		0	0		0	0	
Storage Cap Reductn	0	0		0	0		0	0		0	0	
Reduced v/c Ratio	0.18	0.69		0.18	0.66		0.62	0.19		0.28	0.33	

Intersection Summary

Area Type: Other
 Cycle Length: 110
 Actuated Cycle Length: 110
 Offset: 20 (18%), Referenced to phase 2:EBTL and 6:WBTL, Start of Green
 Natural Cycle: 80
 Control Type: Actuated-Coordinated
 Maximum v/c Ratio: 0.83
 Intersection Signal Delay: 17.0 Intersection LOS: B
 Intersection Capacity Utilization 82.3% ICU Level of Service E
 Analysis Period (min) 15
 m Volume for 95th percentile queue is metered by upstream signal.

Splits and Phases: 1: Don Reid/Ryder & Walkley

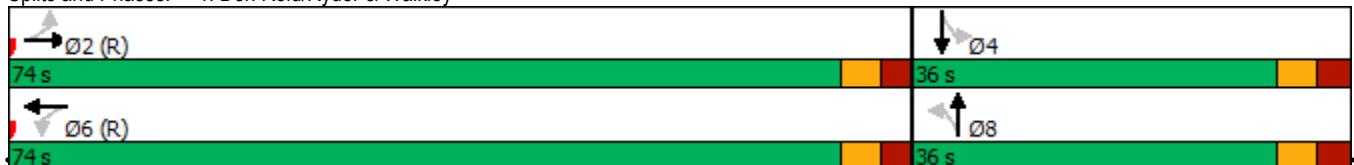

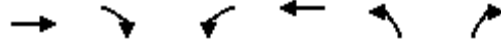

Lane Group	EBT	EBR	WBL	WBT	NBL	NBR
Lane Configurations	↑↑	↑	↑	↑↑	↑	↑
Traffic Volume (vph)	1590	64	36	1456	49	41
Future Volume (vph)	1590	64	36	1456	49	41
Ideal Flow (vphpl)	1800	1800	1800	1800	1800	1800
Storage Length (m)		20.0	65.0		30.0	0.0
Storage Lanes		1	1		1	1
Taper Length (m)			25.0		30.0	
Lane Util. Factor	0.95	1.00	1.00	0.95	1.00	1.00
Ped Bike Factor		0.95	1.00		0.99	0.98
Fr _t		0.850				0.850
Fl _t Protected			0.950		0.950	
Satd. Flow (prot)	3252	1483	1642	3316	1658	1483
Fl _t Permitted			0.135		0.950	
Satd. Flow (perm)	3252	1413	233	3316	1646	1455
Right Turn on Red		Yes				Yes
Satd. Flow (RTOR)		30				41
Link Speed (k/h)	50			50	50	
Link Distance (m)	171.1			169.1	128.6	
Travel Time (s)	12.3			12.2	9.3	
Confl. Peds. (#/hr)		15	15		5	5
Confl. Bikes (#/hr)		3				
Peak Hour Factor	1.00	1.00	1.00	1.00	1.00	1.00
Heavy Vehicles (%)	4%	2%	3%	2%	2%	2%
Adj. Flow (vph)	1590	64	36	1456	49	41
Shared Lane Traffic (%)						
Lane Group Flow (vph)	1590	64	36	1456	49	41
Enter Blocked Intersection	No	No	No	No	No	No
Lane Alignment	Left	Right	L NA	Left	L NA	R NA
Median Width(m)	3.5			5.0	3.5	
Link Offset(m)	0.0			0.0	0.0	
Crosswalk Width(m)	5.0			5.0	5.0	
Two way Left Turn Lane						
Headway Factor	1.09	1.09	1.09	1.09	1.09	1.09
Turning Speed (k/h)		14	24		24	14
Number of Detectors	2	1	1	2	1	1
Detector Template	Thru	Right	Left	Thru	Left	Right
Leading Detector (m)	30.5	6.1	6.1	30.5	6.1	6.1
Trailing Detector (m)	0.0	0.0	0.0	0.0	0.0	0.0
Detector 1 Position(m)	0.0	0.0	0.0	0.0	0.0	0.0
Detector 1 Size(m)	1.8	6.1	6.1	1.8	6.1	6.1
Detector 1 Type	Cl+Ex	Cl+Ex	Cl+Ex	Cl+Ex	Cl+Ex	Cl+Ex
Detector 1 Channel						
Detector 1 Extend (s)	0.0	0.0	0.0	0.0	0.0	0.0
Detector 1 Queue (s)	0.0	0.0	0.0	0.0	0.0	0.0
Detector 1 Delay (s)	0.0	0.0	0.0	0.0	0.0	0.0
Detector 2 Position(m)	28.7			28.7		
Detector 2 Size(m)	1.8			1.8		
Detector 2 Type	Cl+Ex			Cl+Ex		
Detector 2 Channel						
Detector 2 Extend (s)	0.0			0.0		
Turn Type	NA	Perm	Perm	NA	Prot	Perm
Protected Phases	2			6	8	
Permitted Phases		2	6			8
Detector Phase	2	2	6	6	8	8

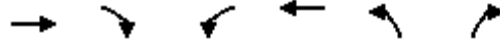







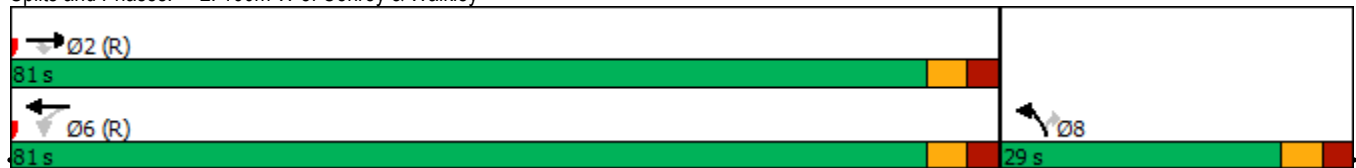

Lane Group	EBT	EBR	WBL	WBT	NBL	NBR
Switch Phase						
Minimum Initial (s)	10.0	10.0	10.0	10.0	5.0	5.0
Minimum Split (s)	37.0	37.0	37.0	37.0	29.0	29.0
Total Split (s)	81.0	81.0	81.0	81.0	29.0	29.0
Total Split (%)	73.6%	73.6%	73.6%	73.6%	26.4%	26.4%
Maximum Green (s)	75.0	75.0	75.0	75.0	23.0	23.0
Yellow Time (s)	3.3	3.3	3.3	3.3	3.3	3.3
All-Red Time (s)	2.7	2.7	2.7	2.7	2.7	2.7
Lost Time Adjust (s)	0.0	0.0	0.0	0.0	0.0	0.0
Total Lost Time (s)	6.0	6.0	6.0	6.0	6.0	6.0
Lead/Lag						
Lead-Lag Optimize?						
Vehicle Extension (s)	3.0	3.0	3.0	3.0	3.0	3.0
Recall Mode	C-Max	C-Max	C-Max	C-Max	None	None
Walk Time (s)	18.0	18.0			7.0	7.0
Flash Dont Walk (s)	13.0	13.0			16.0	16.0
Pedestrian Calls (#/hr)	5	5			5	5
Act Effct Green (s)	90.6	90.6	90.6	90.6	10.9	10.9
Actuated g/C Ratio	0.82	0.82	0.82	0.82	0.10	0.10
v/c Ratio	0.59	0.05	0.19	0.53	0.30	0.23
Control Delay	2.2	0.8	7.8	6.6	48.0	15.0
Queue Delay	0.0	0.0	0.0	0.1	0.0	0.0
Total Delay	2.2	0.8	7.8	6.7	48.0	15.0
LOS	A	A	A	A	D	B
Approach Delay	2.1			6.8	32.9	
Approach LOS	A			A	C	
Queue Length 50th (m)	15.4	0.2	0.8	58.9	9.4	0.0
Queue Length 95th (m)	22.6	m0.8	m8.1	112.4	17.5	8.2
Internal Link Dist (m)	147.1			145.1	104.6	
Turn Bay Length (m)		20.0	65.0		30.0	
Base Capacity (vph)	2679	1169	192	2731	346	336
Starvation Cap Reductn	102	0	0	330	0	0
Spillback Cap Reductn	79	0	0	0	0	1
Storage Cap Reductn	0	0	0	0	0	0
Reduced v/c Ratio	0.62	0.05	0.19	0.61	0.14	0.12

Intersection Summary

Area Type: Other
 Cycle Length: 110
 Actuated Cycle Length: 110
 Offset: 25 (23%), Referenced to phase 2:EBT and 6:WBTL, Start of Green
 Natural Cycle: 70
 Control Type: Actuated-Coordinated
 Maximum v/c Ratio: 0.59
 Intersection Signal Delay: 5.1
 Intersection LOS: A
 Intersection Capacity Utilization 62.9%
 ICU Level of Service B
 Analysis Period (min) 15
 m Volume for 95th percentile queue is metered by upstream signal.

Splits and Phases: 2: 160m W of Conroy & Walkley



							
Lane Group	EBT	EBR	WBL	WBT	NBU	NBL	NBR
Lane Configurations	↑↑	↑	↑↑	↑↑		↑↑	↑
Traffic Volume (vph)	1179	452	518	999	43	461	319
Future Volume (vph)	1179	452	518	999	43	461	319
Ideal Flow (vphpl)	1800	1800	1800	1800	1800	1800	1800
Storage Length (m)		75.0	200.0			0.0	0.0
Storage Lanes		1	2			2	1
Taper Length (m)			50.0			10.0	
Lane Util. Factor	0.95	1.00	0.97	0.95	0.95	0.97	1.00
Ped Bike Factor		0.95	0.99				0.96
Fr t		0.850					0.850
Flt Protected			0.950			0.950	
Satd. Flow (prot)	3221	1483	3185	3349	0	3248	1469
Flt Permitted			0.950			0.950	
Satd. Flow (perm)	3221	1414	3151	3349	0	3248	1406
Right Turn on Red		Yes					Yes
Satd. Flow (RTOR)		452					319
Link Speed (k/h)	50			50		60	
Link Distance (m)	169.1			271.7		348.5	
Travel Time (s)	12.2			19.6		20.9	
Confl. Peds. (#/hr)		30	30				20
Confl. Bikes (#/hr)		4					4
Peak Hour Factor	1.00	1.00	1.00	1.00	1.00	1.00	1.00
Heavy Vehicles (%)	5%	2%	3%	1%	1%	1%	3%
Adj. Flow (vph)	1179	452	518	999	43	461	319
Shared Lane Traffic (%)							
Lane Group Flow (vph)	1179	452	518	999	0	504	319
Enter Blocked Intersection	No	No	No	No	No	No	No
Lane Alignment	Left	R NA	Left	Left	R NA	L NA	R NA
Median Width(m)	7.0			9.0		10.5	
Link Offset(m)	0.0			0.0		0.0	
Crosswalk Width(m)	5.0			5.0		5.0	
Two way Left Turn Lane							
Headway Factor	1.09	1.09	1.09	1.09	1.09	1.09	1.09
Turning Speed (k/h)		14	24		14	24	14
Number of Detectors	2	1	1	2	1	1	1
Detector Template	Thru	Right	Left	Thru	Left	Left	Right
Leading Detector (m)	30.5	6.1	6.1	30.5	6.1	6.1	6.1
Trailing Detector (m)	0.0	0.0	0.0	0.0	0.0	0.0	0.0
Detector 1 Position(m)	0.0	0.0	0.0	0.0	0.0	0.0	0.0
Detector 1 Size(m)	1.8	6.1	6.1	1.8	6.1	6.1	6.1
Detector 1 Type	Cl+Ex	Cl+Ex	Cl+Ex	Cl+Ex	Cl+Ex	Cl+Ex	Cl+Ex
Detector 1 Channel							
Detector 1 Extend (s)	0.0	0.0	0.0	0.0	0.0	0.0	0.0
Detector 1 Queue (s)	0.0	0.0	0.0	0.0	0.0	0.0	0.0
Detector 1 Delay (s)	0.0	0.0	0.0	0.0	0.0	0.0	0.0
Detector 2 Position(m)	28.7			28.7			
Detector 2 Size(m)	1.8			1.8			
Detector 2 Type	Cl+Ex			Cl+Ex			
Detector 2 Channel							
Detector 2 Extend (s)	0.0			0.0			
Turn Type	NA	Perm	Prot	NA	Perm	Prot	Perm
Protected Phases	2		1	6		8	
Permitted Phases		2			8		8
Detector Phase	2	2	1	6	8	8	8



Lane Group	EBT	EBR	WBL	WBT	NBU	NBL	NBR
Switch Phase							
Minimum Initial (s)	10.0	10.0	5.0	10.0	5.0	5.0	5.0
Minimum Split (s)	36.4	36.4	16.0	24.7	30.4	30.4	30.4
Total Split (s)	51.0	51.0	28.0	79.0	31.0	31.0	31.0
Total Split (%)	46.4%	46.4%	25.5%	71.8%	28.2%	28.2%	28.2%
Maximum Green (s)	44.6	44.6	21.8	72.6	24.6	24.6	24.6
Yellow Time (s)	3.7	3.7	3.3	3.7	3.7	3.7	3.7
All-Red Time (s)	2.7	2.7	2.9	2.7	2.7	2.7	2.7
Lost Time Adjust (s)	0.0	0.0	0.0	0.0		0.0	0.0
Total Lost Time (s)	6.4	6.4	6.2	6.4		6.4	6.4
Lead/Lag	Lag	Lag	Lead				
Lead-Lag Optimize?	Yes	Yes	Yes				
Vehicle Extension (s)	3.0	3.0	3.0	3.0	3.0	3.0	3.0
Recall Mode	C-Max	C-Max	None	C-Max	None	None	None
Walk Time (s)	10.0	10.0			7.0	7.0	7.0
Flash Dont Walk (s)	20.0	20.0			17.0	17.0	17.0
Pedestrian Calls (#/hr)	20	20			15	15	15
Act Effct Green (s)	48.1	48.1	21.2	75.4		21.8	21.8
Actuated g/C Ratio	0.44	0.44	0.19	0.69		0.20	0.20
v/c Ratio	0.84	0.52	0.85	0.44		0.78	0.60
Control Delay	32.2	6.6	56.6	8.8		50.9	9.1
Queue Delay	0.0	0.0	0.0	0.0		0.0	0.0
Total Delay	32.2	6.6	56.6	8.8		50.9	9.1
LOS	C	A	E	A		D	A
Approach Delay	25.1			25.1		34.7	
Approach LOS	C			C		C	
Queue Length 50th (m)	72.1	0.0	50.0	43.5		48.4	0.0
Queue Length 95th (m)	#149.0	31.6	#72.9	57.4		63.9	21.3
Internal Link Dist (m)	145.1			247.7		324.5	
Turn Bay Length (m)		75.0	200.0				
Base Capacity (vph)	1407	872	640	2296		726	562
Starvation Cap Reductn	0	0	0	0		0	0
Spillback Cap Reductn	0	0	0	0		0	0
Storage Cap Reductn	0	0	0	0		0	0
Reduced v/c Ratio	0.84	0.52	0.81	0.44		0.69	0.57

Intersection Summary

Area Type: Other
 Cycle Length: 110
 Actuated Cycle Length: 110
 Offset: 20 (18%), Referenced to phase 2:EBT and 6:WBT, Start of Green
 Natural Cycle: 85
 Control Type: Actuated-Coordinated
 Maximum v/c Ratio: 0.85
 Intersection Signal Delay: 27.1 Intersection LOS: C
 Intersection Capacity Utilization 83.4% ICU Level of Service E
 Analysis Period (min) 15
 # 95th percentile volume exceeds capacity, queue may be longer.
 Queue shown is maximum after two cycles.

Splits and Phases: 3: Conroy & Walkley



4: Conroy & St. Laurent
PM Peak Hour

2510 St. Laurent Boulevard
2024 Total Traffic

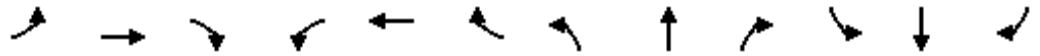

Lane Group	EBL	EBT	EBR	WBL	WBT	WBR	NBL	NBT	NBR	SBL	SBT	SBR
Lane Configurations												
Traffic Volume (vph)	47	81	322	232	38	102	47	567	81	37	1058	21
Future Volume (vph)	47	81	322	232	38	102	47	567	81	37	1058	21
Ideal Flow (vphpl)	1800	1800	1800	1800	1800	1800	1800	1800	1800	1800	1800	1800
Storage Length (m)	45.0		50.0	55.0		55.0	0.0		0.0	110.0		0.0
Storage Lanes	1		1	1		1	1		0	1		0
Taper Length (m)	40.0			40.0			10.0			25.0		
Lane Util. Factor	1.00	1.00	1.00	1.00	1.00	1.00	1.00	0.91	0.91	1.00	0.95	0.95
Ped Bike Factor	0.99		0.98	0.99		0.98	1.00	0.99		0.99	1.00	
Fr _t			0.850			0.850		0.981			0.997	
Fl _t Protected	0.950			0.950			0.950			0.950		
Satd. Flow (prot)	1674	1728	1483	1642	1618	1483	1642	4602	0	1537	3296	0
Fl _t Permitted	0.732			0.555			0.169			0.384		
Satd. Flow (perm)	1281	1728	1452	953	1618	1453	291	4602	0	612	3296	0
Right Turn on Red			Yes			Yes			Yes			Yes
Satd. Flow (RTOR)			122			82		29				2
Link Speed (k/h)		50			50			60			60	
Link Distance (m)		197.7			271.8			372.7			348.5	
Travel Time (s)		14.2			19.6			22.4			20.9	
Confl. Peds. (#/hr)	10		10	10		10	10		20	20		10
Confl. Bikes (#/hr)			3			3			5			14
Peak Hour Factor	1.00	1.00	1.00	1.00	1.00	1.00	1.00	1.00	1.00	1.00	1.00	1.00
Heavy Vehicles (%)	1%	3%	2%	3%	10%	2%	3%	2%	8%	10%	2%	12%
Adj. Flow (vph)	47	81	322	232	38	102	47	567	81	37	1058	21
Shared Lane Traffic (%)												
Lane Group Flow (vph)	47	81	322	232	38	102	47	648	0	37	1079	0
Enter Blocked Intersection	No	No	No	No	No	No	No	No	No	No	No	No
Lane Alignment	L NA	Left	R NA	L NA	Left	R NA	Left	Left	Right	L NA	Left	R NA
Median Width(m)		3.5			3.5			7.0			6.0	
Link Offset(m)		0.0			0.0			0.0			0.0	
Crosswalk Width(m)		5.0			5.0			5.0			5.0	
Two way Left Turn Lane												
Headway Factor	1.09	1.09	1.09	1.09	1.09	1.09	1.09	1.09	1.09	1.09	1.09	1.09
Turning Speed (k/h)	24		14	24		14	24		14	24		14
Number of Detectors	1	2	1	1	2	1	1	2		1	2	
Detector Template	Left	Thru	Right	Left	Thru	Right	Left	Thru		Left	Thru	
Leading Detector (m)	6.1	30.5	6.1	6.1	30.5	6.1	6.1	30.5		6.1	30.5	
Trailing Detector (m)	0.0	0.0	0.0	0.0	0.0	0.0	0.0	0.0		0.0	0.0	
Detector 1 Position(m)	0.0	0.0	0.0	0.0	0.0	0.0	0.0	0.0		0.0	0.0	
Detector 1 Size(m)	6.1	1.8	6.1	6.1	1.8	6.1	6.1	1.8		6.1	1.8	
Detector 1 Type	Cl+Ex	Cl+Ex	Cl+Ex	Cl+Ex	Cl+Ex	Cl+Ex	Cl+Ex	Cl+Ex		Cl+Ex	Cl+Ex	
Detector 1 Channel												
Detector 1 Extend (s)	0.0	0.0	0.0	0.0	0.0	0.0	0.0	0.0		0.0	0.0	
Detector 1 Queue (s)	0.0	0.0	0.0	0.0	0.0	0.0	0.0	0.0		0.0	0.0	
Detector 1 Delay (s)	0.0	0.0	0.0	0.0	0.0	0.0	0.0	0.0		0.0	0.0	
Detector 2 Position(m)		28.7			28.7			28.7			28.7	
Detector 2 Size(m)		1.8			1.8			1.8			1.8	
Detector 2 Type		Cl+Ex			Cl+Ex			Cl+Ex			Cl+Ex	
Detector 2 Channel												
Detector 2 Extend (s)		0.0			0.0			0.0			0.0	
Turn Type	Perm	NA	Perm	pm+pt	NA	Perm	Perm	NA		Perm	NA	
Protected Phases		4		3	8			2			6	
Permitted Phases	4		4	8		8	2			6		
Detector Phase	4	4	4	3	8	8	2	2		6	6	

4: Conroy & St. Laurent
PM Peak Hour

2510 St. Laurent Boulevard
2024 Total Traffic

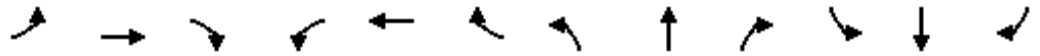

Lane Group	EBL	EBT	EBR	WBL	WBT	WBR	NBL	NBT	NBR	SBL	SBT	SBR
Switch Phase												
Minimum Initial (s)	10.0	10.0	10.0	5.0	10.0	10.0	10.0	10.0		10.0	10.0	
Minimum Split (s)	43.9	43.9	43.9	11.3	43.9	43.9	30.3	30.3		30.3	30.3	
Total Split (s)	44.0	44.0	44.0	15.0	59.0	59.0	36.0	36.0		36.0	36.0	
Total Split (%)	46.3%	46.3%	46.3%	15.8%	62.1%	62.1%	37.9%	37.9%		37.9%	37.9%	
Maximum Green (s)	37.1	37.1	37.1	9.3	52.1	52.1	29.7	29.7		29.7	29.7	
Yellow Time (s)	3.3	3.3	3.3	3.3	3.3	3.3	3.7	3.7		3.7	3.7	
All-Red Time (s)	3.6	3.6	3.6	2.4	3.6	3.6	2.6	2.6		2.6	2.6	
Lost Time Adjust (s)	0.0	0.0	0.0	0.0	0.0	0.0	0.0	0.0		0.0	0.0	
Total Lost Time (s)	6.9	6.9	6.9	5.7	6.9	6.9	6.3	6.3		6.3	6.3	
Lead/Lag	Lag	Lag	Lag	Lead								
Lead-Lag Optimize?	Yes	Yes	Yes	Yes								
Vehicle Extension (s)	3.0	3.0	3.0	3.0	3.0	3.0	3.0	3.0		3.0	3.0	
Recall Mode	None	None	None	None	None	None	C-Max	C-Max		C-Max	C-Max	
Walk Time (s)	7.0	7.0	7.0		7.0	7.0	7.0	7.0		7.0	7.0	
Flash Dont Walk (s)	30.0	30.0	30.0		30.0	30.0	17.0	17.0		17.0	17.0	
Pedestrian Calls (#/hr)	5	5	5		5	5	10	10		10	10	
Act Effct Green (s)	21.2	21.2	21.2	37.4	36.2	36.2	45.6	45.6		45.6	45.6	
Actuated g/C Ratio	0.22	0.22	0.22	0.39	0.38	0.38	0.48	0.48		0.48	0.48	
v/c Ratio	0.16	0.21	0.77	0.52	0.06	0.17	0.34	0.29		0.13	0.68	
Control Delay	26.7	27.8	32.2	23.2	15.2	5.2	30.5	16.5		20.1	24.6	
Queue Delay	0.0	0.0	0.0	0.0	0.0	0.0	0.0	0.0		0.0	0.0	
Total Delay	26.7	27.8	32.2	23.2	15.2	5.2	30.5	16.5		20.1	24.6	
LOS	C	C	C	C	B	A	C	B		C	C	
Approach Delay		30.8			17.5			17.5			24.5	
Approach LOS		C			B			B			C	
Queue Length 50th (m)	6.6	11.5	32.9	28.1	4.2	2.2	4.5	21.2		3.2	68.2	
Queue Length 95th (m)	11.5	17.2	46.8	30.7	6.9	7.9	#20.7	40.1		12.0	#141.2	
Internal Link Dist (m)		173.7			247.8			348.7			324.5	
Turn Bay Length (m)	45.0		50.0	55.0		55.0				110.0		
Base Capacity (vph)	500	674	641	442	887	833	139	2224		293	1583	
Starvation Cap Reductn	0	0	0	0	0	0	0	0		0	0	
Spillback Cap Reductn	0	0	0	0	0	0	0	0		0	0	
Storage Cap Reductn	0	0	0	0	0	0	0	0		0	0	
Reduced v/c Ratio	0.09	0.12	0.50	0.52	0.04	0.12	0.34	0.29		0.13	0.68	

Intersection Summary

Area Type: Other
 Cycle Length: 95
 Actuated Cycle Length: 95
 Offset: 2 (2%), Referenced to phase 2:NBTL and 6:SBTL, Start of Green
 Natural Cycle: 90
 Control Type: Actuated-Coordinated
 Maximum v/c Ratio: 0.77
 Intersection Signal Delay: 22.7 Intersection LOS: C
 Intersection Capacity Utilization 85.5% ICU Level of Service E
 Analysis Period (min) 15
 # 95th percentile volume exceeds capacity, queue may be longer.
 Queue shown is maximum after two cycles.

Splits and Phases: 4: Conroy & St. Laurent

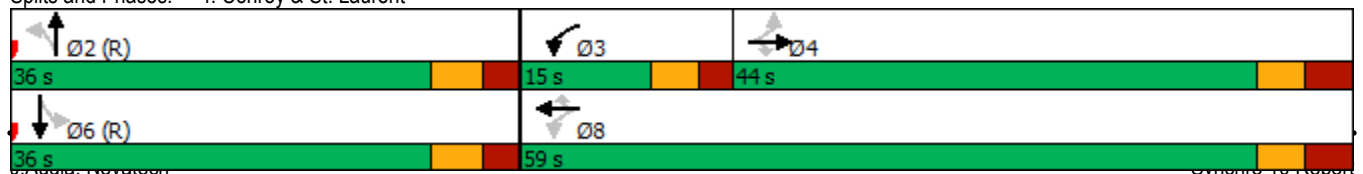



Lane Group	WBL	WBR	NBT	NBR	SBL	SBT
Lane Configurations						
Traffic Volume (vph)	23	96	107	76	172	51
Future Volume (vph)	23	96	107	76	172	51
Ideal Flow (vphpl)	1800	1800	1800	1800	1800	1800
Lane Util. Factor	1.00	1.00	1.00	1.00	1.00	1.00
Ped Bike Factor						
Frt	0.891		0.944			
Flt Protected	0.990					0.963
Satd. Flow (prot)	1462	0	1641	0	0	1592
Flt Permitted	0.990					0.963
Satd. Flow (perm)	1462	0	1641	0	0	1592
Link Speed (k/h)	50		50			50
Link Distance (m)	137.6		234.0			146.3
Travel Time (s)	9.9		16.8			10.5
Confl. Peds. (#/hr)				5	5	
Confl. Bikes (#/hr)		4		5		
Peak Hour Factor	1.00	1.00	1.00	1.00	1.00	1.00
Heavy Vehicles (%)	5%	8%	2%	3%	4%	20%
Adj. Flow (vph)	23	96	107	76	172	51
Shared Lane Traffic (%)						
Lane Group Flow (vph)	119	0	183	0	0	223
Enter Blocked Intersection	No	No	No	No	No	No
Lane Alignment	Left	Right	Left	Right	Left	Left
Median Width(m)	3.5		0.0			0.0
Link Offset(m)	0.0		0.0			0.0
Crosswalk Width(m)	2.0		10.0			10.0
Two way Left Turn Lane						
Headway Factor	1.09	1.09	1.09	1.09	1.09	1.09
Turning Speed (k/h)	24	14		14	24	
Sign Control	Stop		Free			Free

Intersection Summary

Area Type: Other

Control Type: Unsignalized

Intersection Capacity Utilization 41.9%

ICU Level of Service A

Analysis Period (min) 15



Lane Group	EBL	EBT	WBT	WBR	SBL	SBR
Lane Configurations		↕	↕		↕	
Traffic Volume (vph)	1	249	122	11	9	1
Future Volume (vph)	1	249	122	11	9	1
Ideal Flow (vphpl)	1800	1800	1800	1800	1800	1800
Lane Util. Factor	1.00	1.00	1.00	1.00	1.00	1.00
Ped Bike Factor						
Frt			0.989		0.986	
Flt Protected					0.957	
Satd. Flow (prot)	0	1695	1682	0	1663	0
Flt Permitted					0.957	
Satd. Flow (perm)	0	1695	1682	0	1663	0
Link Speed (k/h)		50	50		50	
Link Distance (m)		40.4	197.7		90.8	
Travel Time (s)		2.9	14.2		6.5	
Confl. Peds. (#/hr)	10			10		
Confl. Bikes (#/hr)				3		3
Peak Hour Factor	1.00	1.00	1.00	1.00	1.00	1.00
Heavy Vehicles (%)	1%	5%	5%	1%	1%	1%
Adj. Flow (vph)	1	249	122	11	9	1
Shared Lane Traffic (%)						
Lane Group Flow (vph)	0	250	133	0	10	0
Enter Blocked Intersection	No	No	No	No	No	No
Lane Alignment	Left	Left	Left	Right	Left	Right
Median Width(m)		0.0	3.5		3.5	
Link Offset(m)		0.0	0.0		0.0	
Crosswalk Width(m)		0.0	0.0		5.0	
Two way Left Turn Lane						
Headway Factor	1.09	1.09	1.09	1.09	1.09	1.09
Turning Speed (k/h)	24			14	24	14
Sign Control		Free	Free		Stop	

Intersection Summary

Area Type:	Other
Control Type:	Unsignalized
Intersection Capacity Utilization	24.7%
ICU Level of Service	A
Analysis Period (min)	15

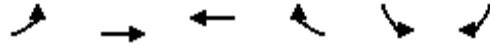

Lane Group	EBL	EBT	WBT	WBR	SBL	SBR
Lane Configurations						
Traffic Volume (vph)	1	247	119	4	3	0
Future Volume (vph)	1	247	119	4	3	0
Ideal Flow (vphpl)	1800	1800	1800	1800	1800	1800
Lane Util. Factor	1.00	1.00	1.00	1.00	1.00	1.00
Ped Bike Factor						
Frt	0.996					
Flt Protected	0.950					
Satd. Flow (prot)	0	1695	1691	0	1674	0
Flt Permitted	0.950					
Satd. Flow (perm)	0	1695	1691	0	1674	0
Link Speed (k/h)	50					
Link Distance (m)	137.6		40.4		92.1	
Travel Time (s)	9.9		2.9		6.6	
Confl. Peds. (#/hr)	10					10
Confl. Bikes (#/hr)					3	3
Peak Hour Factor	1.00	1.00	1.00	1.00	1.00	1.00
Heavy Vehicles (%)	1%	5%	5%	1%	1%	1%
Adj. Flow (vph)	1	247	119	4	3	0
Shared Lane Traffic (%)						
Lane Group Flow (vph)	0	248	123	0	3	0
Enter Blocked Intersection	No	No	No	No	No	No
Lane Alignment	Left	Left	Left	Right	Left	Right
Median Width(m)	0.0		0.0		3.5	
Link Offset(m)	0.0		0.0		0.0	
Crosswalk Width(m)	0.0		0.0		5.0	
Two way Left Turn Lane						
Headway Factor	1.09	1.09	1.09	1.09	1.09	1.09
Turning Speed (k/h)	24				14	24
Sign Control	Free		Free		Stop	

Intersection Summary

Area Type: Other

Control Type: Unsignalized

Intersection Capacity Utilization 24.6% ICU Level of Service A

Analysis Period (min) 15



Lane Group	WBL	WBR	NBT	NBR	SBL	SBT
Lane Configurations						
Traffic Volume (vph)	1	10	238	1	13	223
Future Volume (vph)	1	10	238	1	13	223
Ideal Flow (vphpl)	1800	1800	1800	1800	1800	1800
Lane Util. Factor	1.00	1.00	1.00	1.00	1.00	1.00
Ped Bike Factor						
Frt	0.877		0.999			
Flt Protected	0.995					0.997
Satd. Flow (prot)	1538	0	1694	0	0	1694
Flt Permitted	0.995					0.997
Satd. Flow (perm)	1538	0	1694	0	0	1694
Link Speed (k/h)	50		50			50
Link Distance (m)	105.3		30.4			100.3
Travel Time (s)	7.6		2.2			7.2
Confl. Peds. (#/hr)				10	10	
Confl. Bikes (#/hr)		3		3		
Peak Hour Factor	1.00	1.00	1.00	1.00	1.00	1.00
Heavy Vehicles (%)	1%	1%	5%	1%	1%	5%
Adj. Flow (vph)	1	10	238	1	13	223
Shared Lane Traffic (%)						
Lane Group Flow (vph)	11	0	239	0	0	236
Enter Blocked Intersection	No	No	No	No	No	No
Lane Alignment	Left	Right	Left	Right	Left	Left
Median Width(m)	3.5		3.5			3.5
Link Offset(m)	0.0		0.0			0.0
Crosswalk Width(m)	5.0		0.0			0.0
Two way Left Turn Lane						
Headway Factor	1.09	1.09	1.09	1.09	1.09	1.09
Turning Speed (k/h)	24	14		14	24	
Sign Control	Stop		Free			Free

Intersection Summary

Area Type:	Other
Control Type:	Unsignalized
Intersection Capacity Utilization	33.6%
ICU Level of Service	A
Analysis Period (min)	15

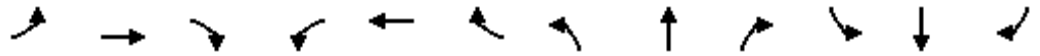

Lane Group	EBL	EBT	EBR	WBL	WBT	WBR	NBL	NBT	NBR	SBL	SBT	SBR
Lane Configurations												
Traffic Volume (vph)	29	1125	173	46	1531	195	96	7	60	49	47	39
Future Volume (vph)	29	1125	173	46	1531	195	96	7	60	49	47	39
Ideal Flow (vphpl)	1800	1800	1800	1800	1800	1800	1800	1800	1800	1800	1800	1800
Storage Length (m)	40.0		0.0	50.0		0.0	35.0		0.0	30.0		0.0
Storage Lanes	1		0	1		0	1		0	1		0
Taper Length (m)	25.0			30.0			25.0			30.0		
Lane Util. Factor	1.00	0.95	0.95	1.00	0.95	0.95	1.00	1.00	1.00	1.00	1.00	1.00
Ped Bike Factor		0.99		1.00	1.00		1.00	0.98		1.00	0.99	
Frt		0.980			0.983			0.866			0.932	
Flt Protected	0.950			0.950			0.950			0.950		
Satd. Flow (prot)	1537	3183	0	1642	3169	0	1580	1367	0	1674	1630	0
Flt Permitted	0.099			0.184			0.701			0.713		
Satd. Flow (perm)	160	3183	0	317	3169	0	1161	1367	0	1251	1630	0
Right Turn on Red			Yes			Yes			Yes			Yes
Satd. Flow (RTOR)		29			23			60			30	
Link Speed (k/h)		50			50			50			50	
Link Distance (m)		402.0			171.1			100.3			281.0	
Travel Time (s)		28.9			12.3			7.2			20.2	
Confl. Peds. (#/hr)	5		10	10		5	5		5	5		5
Confl. Bikes (#/hr)			3			3			3			
Peak Hour Factor	1.00	1.00	1.00	1.00	1.00	1.00	1.00	1.00	1.00	1.00	1.00	1.00
Heavy Vehicles (%)	10%	4%	1%	3%	5%	1%	7%	1%	12%	1%	1%	1%
Adj. Flow (vph)	29	1125	173	46	1531	195	96	7	60	49	47	39
Shared Lane Traffic (%)												
Lane Group Flow (vph)	29	1298	0	46	1726	0	96	67	0	49	86	0
Enter Blocked Intersection	No	No	No	No	No	No	No	No	No	No	No	No
Lane Alignment	L NA	Left	R NA	Left	Left	Right	L NA	Left	R NA	L NA	Left	R NA
Median Width(m)		5.0			5.0			3.5			3.5	
Link Offset(m)		0.0			0.0			0.0			0.0	
Crosswalk Width(m)		5.0			5.0			5.0			5.0	
Two way Left Turn Lane												
Headway Factor	1.09	1.09	1.09	1.09	1.09	1.09	1.09	1.09	1.09	1.09	1.09	1.09
Turning Speed (k/h)	24		14	24		14	24		14	24		14
Number of Detectors	1	2		1	2		1	2		1	2	
Detector Template	Left	Thru		Left	Thru		Left	Thru		Left	Thru	
Leading Detector (m)	6.1	30.5		6.1	30.5		6.1	30.5		6.1	30.5	
Trailing Detector (m)	0.0	0.0		0.0	0.0		0.0	0.0		0.0	0.0	
Detector 1 Position(m)	0.0	0.0		0.0	0.0		0.0	0.0		0.0	0.0	
Detector 1 Size(m)	6.1	1.8		6.1	1.8		6.1	1.8		6.1	1.8	
Detector 1 Type	Cl+Ex	Cl+Ex		Cl+Ex	Cl+Ex		Cl+Ex	Cl+Ex		Cl+Ex	Cl+Ex	
Detector 1 Channel												
Detector 1 Extend (s)	0.0	0.0		0.0	0.0		0.0	0.0		0.0	0.0	
Detector 1 Queue (s)	0.0	0.0		0.0	0.0		0.0	0.0		0.0	0.0	
Detector 1 Delay (s)	0.0	0.0		0.0	0.0		0.0	0.0		0.0	0.0	
Detector 2 Position(m)		28.7			28.7			28.7			28.7	
Detector 2 Size(m)		1.8			1.8			1.8			1.8	
Detector 2 Type		Cl+Ex			Cl+Ex			Cl+Ex			Cl+Ex	
Detector 2 Channel												
Detector 2 Extend (s)		0.0			0.0			0.0			0.0	
Turn Type	Perm	NA		Perm	NA		Perm	NA		Perm	NA	
Protected Phases		2			6			8			4	
Permitted Phases	2			6			8			4		
Detector Phase	2	2		6	6		8	8		4	4	

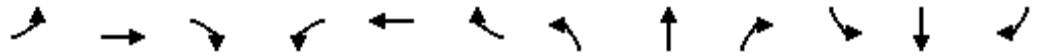

Lane Group	EBL	EBT	EBR	WBL	WBT	WBR	NBL	NBT	NBR	SBL	SBT	SBR
Switch Phase												
Minimum Initial (s)	10.0	10.0		10.0	10.0		10.0	10.0		10.0	10.0	
Minimum Split (s)	35.9	35.9		35.9	35.9		36.2	36.2		36.2	36.2	
Total Split (s)	64.0	64.0		64.0	64.0		36.0	36.0		36.0	36.0	
Total Split (%)	64.0%	64.0%		64.0%	64.0%		36.0%	36.0%		36.0%	36.0%	
Maximum Green (s)	58.1	58.1		58.1	58.1		29.8	29.8		29.8	29.8	
Yellow Time (s)	3.3	3.3		3.3	3.3		3.3	3.3		3.3	3.3	
All-Red Time (s)	2.6	2.6		2.6	2.6		2.9	2.9		2.9	2.9	
Lost Time Adjust (s)	0.0	0.0		0.0	0.0		0.0	0.0		0.0	0.0	
Total Lost Time (s)	5.9	5.9		5.9	5.9		6.2	6.2		6.2	6.2	
Lead/Lag												
Lead-Lag Optimize?												
Vehicle Extension (s)	3.0	3.0		3.0	3.0		3.0	3.0		3.0	3.0	
Recall Mode	C-Max	C-Max		C-Max	C-Max		None	None		None	None	
Walk Time (s)	15.0	15.0		15.0	15.0		10.0	10.0		10.0	10.0	
Flash Dont Walk (s)	15.0	15.0		15.0	15.0		20.0	20.0		20.0	20.0	
Pedestrian Calls (#/hr)	5	5		5	5		5	5		5	5	
Act Effct Green (s)	76.2	76.2		76.2	76.2		16.1	16.1		16.1	16.1	
Actuated g/C Ratio	0.76	0.76		0.76	0.76		0.16	0.16		0.16	0.16	
v/c Ratio	0.24	0.53		0.19	0.71		0.51	0.25		0.24	0.30	
Control Delay	14.2	8.3		6.4	7.2		46.1	11.9		36.4	25.4	
Queue Delay	0.0	0.0		0.0	0.0		0.0	0.0		0.0	0.0	
Total Delay	14.2	8.3		6.4	7.2		46.1	11.9		36.4	25.4	
LOS	B	A		A	A		D	B		D	C	
Approach Delay		8.4			7.2			32.1			29.4	
Approach LOS		A			A			C			C	
Queue Length 50th (m)	1.4	43.0		1.4	28.4		16.4	1.1		8.0	9.1	
Queue Length 95th (m)	9.6	100.6		m3.0	#191.4		25.6	9.6		14.5	17.7	
Internal Link Dist (m)		378.0			147.1			76.3			257.0	
Turn Bay Length (m)	40.0			50.0			35.0			30.0		
Base Capacity (vph)	121	2432		241	2420		345	449		372	506	
Starvation Cap Reductn	0	0		0	20		0	0		0	0	
Spillback Cap Reductn	0	0		0	0		0	0		0	0	
Storage Cap Reductn	0	0		0	0		0	0		0	0	
Reduced v/c Ratio	0.24	0.53		0.19	0.72		0.28	0.15		0.13	0.17	

Intersection Summary

Area Type: Other
 Cycle Length: 100
 Actuated Cycle Length: 100
 Offset: 94 (94%), Referenced to phase 2:EBTL and 6:WBTL, Start of Green
 Natural Cycle: 90
 Control Type: Actuated-Coordinated
 Maximum v/c Ratio: 0.71
 Intersection Signal Delay: 9.8
 Intersection LOS: A
 Intersection Capacity Utilization 75.6%
 ICU Level of Service D
 Analysis Period (min) 15
 # 95th percentile volume exceeds capacity, queue may be longer.
 Queue shown is maximum after two cycles.
 m Volume for 95th percentile queue is metered by upstream signal.

Splits and Phases: 1: Don Reid/Ryder & Walkley

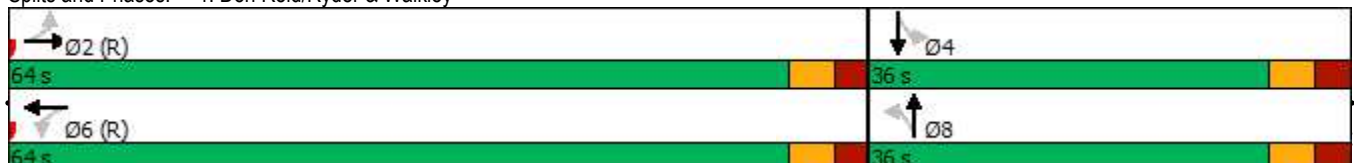



Lane Group	EBT	EBR	WBL	WBT	NBL	NBR
Lane Configurations	↑↑	↑	↑	↑↑	↑	↑
Traffic Volume (vph)	1154	90	74	1724	66	60
Future Volume (vph)	1154	90	74	1724	66	60
Ideal Flow (vphpl)	1800	1800	1800	1800	1800	1800
Storage Length (m)		20.0	65.0		30.0	0.0
Storage Lanes		1	1		1	1
Taper Length (m)			25.0		30.0	
Lane Util. Factor	0.95	1.00	1.00	0.95	1.00	1.00
Ped Bike Factor		0.96	1.00		0.99	0.98
Fr _t		0.850				0.850
Fl _t Protected			0.950		0.950	
Satd. Flow (prot)	3221	1498	1674	3191	1674	1483
Fl _t Permitted			0.229		0.950	
Satd. Flow (perm)	3221	1442	403	3191	1663	1456
Right Turn on Red		Yes				Yes
Satd. Flow (RTOR)		59				60
Link Speed (k/h)	50			50	50	
Link Distance (m)	171.1			169.1	128.6	
Travel Time (s)	12.3			12.2	9.3	
Confl. Peds. (#/hr)		10	10		5	5
Confl. Bikes (#/hr)		3				
Peak Hour Factor	1.00	1.00	1.00	1.00	1.00	1.00
Heavy Vehicles (%)	5%	1%	1%	6%	1%	2%
Adj. Flow (vph)	1154	90	74	1724	66	60
Shared Lane Traffic (%)						
Lane Group Flow (vph)	1154	90	74	1724	66	60
Enter Blocked Intersection	No	No	No	No	No	No
Lane Alignment	Left	Right	L NA	Left	L NA	R NA
Median Width(m)	3.5			5.0	3.5	
Link Offset(m)	0.0			0.0	0.0	
Crosswalk Width(m)	5.0			5.0	5.0	
Two way Left Turn Lane						
Headway Factor	1.09	1.09	1.09	1.09	1.09	1.09
Turning Speed (k/h)		14	24		24	14
Number of Detectors	2	1	1	2	1	1
Detector Template	Thru	Right	Left	Thru	Left	Right
Leading Detector (m)	30.5	6.1	6.1	30.5	6.1	6.1
Trailing Detector (m)	0.0	0.0	0.0	0.0	0.0	0.0
Detector 1 Position(m)	0.0	0.0	0.0	0.0	0.0	0.0
Detector 1 Size(m)	1.8	6.1	6.1	1.8	6.1	6.1
Detector 1 Type	Cl+Ex	Cl+Ex	Cl+Ex	Cl+Ex	Cl+Ex	Cl+Ex
Detector 1 Channel						
Detector 1 Extend (s)	0.0	0.0	0.0	0.0	0.0	0.0
Detector 1 Queue (s)	0.0	0.0	0.0	0.0	0.0	0.0
Detector 1 Delay (s)	0.0	0.0	0.0	0.0	0.0	0.0
Detector 2 Position(m)	28.7			28.7		
Detector 2 Size(m)	1.8			1.8		
Detector 2 Type	Cl+Ex			Cl+Ex		
Detector 2 Channel						
Detector 2 Extend (s)	0.0			0.0		
Turn Type	NA	Perm	Perm	NA	Prot	Perm
Protected Phases	2			6	8	
Permitted Phases		2	6			8
Detector Phase	2	2	6	6	8	8

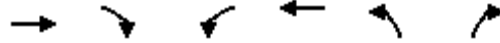







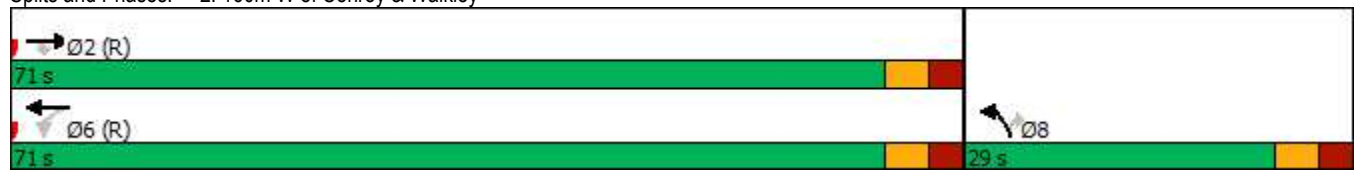

Lane Group	EBT	EBR	WBL	WBT	NBL	NBR
Switch Phase						
Minimum Initial (s)	10.0	10.0	10.0	10.0	5.0	5.0
Minimum Split (s)	37.0	37.0	37.0	37.0	29.0	29.0
Total Split (s)	71.0	71.0	71.0	71.0	29.0	29.0
Total Split (%)	71.0%	71.0%	71.0%	71.0%	29.0%	29.0%
Maximum Green (s)	65.0	65.0	65.0	65.0	23.0	23.0
Yellow Time (s)	3.3	3.3	3.3	3.3	3.3	3.3
All-Red Time (s)	2.7	2.7	2.7	2.7	2.7	2.7
Lost Time Adjust (s)	0.0	0.0	0.0	0.0	0.0	0.0
Total Lost Time (s)	6.0	6.0	6.0	6.0	6.0	6.0
Lead/Lag						
Lead-Lag Optimize?						
Vehicle Extension (s)	3.0	3.0	3.0	3.0	3.0	3.0
Recall Mode	C-Max	C-Max	C-Max	C-Max	None	None
Walk Time (s)	18.0	18.0			7.0	7.0
Flash Dont Walk (s)	13.0	13.0			16.0	16.0
Pedestrian Calls (#/hr)	5	5			5	5
Act Effct Green (s)	80.2	80.2	80.2	80.2	11.3	11.3
Actuated g/C Ratio	0.80	0.80	0.80	0.80	0.11	0.11
v/c Ratio	0.45	0.08	0.23	0.67	0.35	0.28
Control Delay	3.1	1.1	7.0	8.5	43.6	12.6
Queue Delay	0.0	0.0	0.0	0.6	0.0	0.0
Total Delay	3.1	1.1	7.0	9.1	43.6	12.6
LOS	A	A	A	A	D	B
Approach Delay	2.9			9.0	28.8	
Approach LOS	A			A	C	
Queue Length 50th (m)	18.4	0.3	2.7	58.8	11.3	0.0
Queue Length 95th (m)	24.2	1.1	12.5	143.4	19.6	8.9
Internal Link Dist (m)	147.1			145.1	104.6	
Turn Bay Length (m)		20.0	65.0		30.0	
Base Capacity (vph)	2583	1168	323	2560	385	381
Starvation Cap Reductn	0	0	0	405	0	0
Spillback Cap Reductn	0	0	0	70	0	0
Storage Cap Reductn	0	0	0	0	0	0
Reduced v/c Ratio	0.45	0.08	0.23	0.80	0.17	0.16

Intersection Summary

Area Type: Other
 Cycle Length: 100
 Actuated Cycle Length: 100
 Offset: 88 (88%), Referenced to phase 2:EBT and 6:WBTL, Start of Green
 Natural Cycle: 80
 Control Type: Actuated-Coordinated
 Maximum v/c Ratio: 0.67
 Intersection Signal Delay: 7.4
 Intersection LOS: A
 Intersection Capacity Utilization 66.8%
 ICU Level of Service C
 Analysis Period (min) 15

Splits and Phases: 2: 160m W of Conroy & Walkley



							
Lane Group	EBT	EBR	WBL	WBT	NBU	NBL	NBR
Lane Configurations	↑↑	↑	↑↑	↑↑		↑↑	↑
Traffic Volume (vph)	994	280	261	1096	15	717	493
Future Volume (vph)	994	280	261	1096	15	717	493
Ideal Flow (vphpl)	1800	1800	1800	1800	1800	1800	1800
Storage Length (m)		75.0	200.0			0.0	0.0
Storage Lanes		1	2			2	1
Taper Length (m)			50.0			10.0	
Lane Util. Factor	0.95	1.00	0.97	0.95	0.95	0.97	1.00
Ped Bike Factor		0.97	0.99				0.98
Fr _t		0.850					0.850
Fl _t Protected			0.950			0.950	
Satd. Flow (prot)	3161	1455	3066	3161	0	3186	1455
Fl _t Permitted			0.950			0.950	
Satd. Flow (perm)	3161	1409	3043	3161	0	3186	1423
Right Turn on Red		Yes					Yes
Satd. Flow (RTOR)		280					330
Link Speed (k/h)	50			50		60	
Link Distance (m)	169.1			271.7		348.5	
Travel Time (s)	12.2			19.6		20.9	
Confl. Peds. (#/hr)		15	15				5
Confl. Bikes (#/hr)		3					3
Peak Hour Factor	1.00	1.00	1.00	1.00	1.00	1.00	1.00
Heavy Vehicles (%)	7%	4%	7%	7%	2%	3%	4%
Adj. Flow (vph)	994	280	261	1096	15	717	493
Shared Lane Traffic (%)							
Lane Group Flow (vph)	994	280	261	1096	0	732	493
Enter Blocked Intersection	No	No	No	No	No	No	No
Lane Alignment	Left	R NA	Left	Left	R NA	L NA	R NA
Median Width(m)	7.0			9.0		10.5	
Link Offset(m)	0.0			0.0		0.0	
Crosswalk Width(m)	5.0			5.0		5.0	
Two way Left Turn Lane							
Headway Factor	1.09	1.09	1.09	1.09	1.09	1.09	1.09
Turning Speed (k/h)		14	24		14	24	14
Number of Detectors	2	1	1	2	1	1	1
Detector Template	Thru	Right	Left	Thru	Left	Left	Right
Leading Detector (m)	30.5	6.1	6.1	30.5	6.1	6.1	6.1
Trailing Detector (m)	0.0	0.0	0.0	0.0	0.0	0.0	0.0
Detector 1 Position(m)	0.0	0.0	0.0	0.0	0.0	0.0	0.0
Detector 1 Size(m)	1.8	6.1	6.1	1.8	6.1	6.1	6.1
Detector 1 Type	Cl+Ex	Cl+Ex	Cl+Ex	Cl+Ex	Cl+Ex	Cl+Ex	Cl+Ex
Detector 1 Channel							
Detector 1 Extend (s)	0.0	0.0	0.0	0.0	0.0	0.0	0.0
Detector 1 Queue (s)	0.0	0.0	0.0	0.0	0.0	0.0	0.0
Detector 1 Delay (s)	0.0	0.0	0.0	0.0	0.0	0.0	0.0
Detector 2 Position(m)	28.7			28.7			
Detector 2 Size(m)	1.8			1.8			
Detector 2 Type	Cl+Ex			Cl+Ex			
Detector 2 Channel							
Detector 2 Extend (s)	0.0			0.0			
Turn Type	NA	Perm	Prot	NA	Perm	Prot	Perm
Protected Phases	2		1	6		8	
Permitted Phases		2			8		8
Detector Phase	2	2	1	6	8	8	8



Lane Group	EBT	EBR	WBL	WBT	NBU	NBL	NBR
Switch Phase							
Minimum Initial (s)	10.0	10.0	5.0	10.0	5.0	5.0	5.0
Minimum Split (s)	36.4	36.4	16.0	24.7	30.4	30.4	30.4
Total Split (s)	55.0	55.0	25.0	80.0	40.0	40.0	40.0
Total Split (%)	45.8%	45.8%	20.8%	66.7%	33.3%	33.3%	33.3%
Maximum Green (s)	48.6	48.6	18.8	73.6	33.6	33.6	33.6
Yellow Time (s)	3.7	3.7	3.3	3.7	3.7	3.7	3.7
All-Red Time (s)	2.7	2.7	2.9	2.7	2.7	2.7	2.7
Lost Time Adjust (s)	0.0	0.0	0.0	0.0		0.0	0.0
Total Lost Time (s)	6.4	6.4	6.2	6.4		6.4	6.4
Lead/Lag	Lag	Lag	Lead				
Lead-Lag Optimize?	Yes	Yes	Yes				
Vehicle Extension (s)	3.0	3.0	3.0	3.0	3.0	3.0	3.0
Recall Mode	C-Max	C-Max	None	C-Max	None	None	None
Walk Time (s)	10.0	10.0			7.0	7.0	7.0
Flash Dont Walk (s)	20.0	20.0			17.0	17.0	17.0
Pedestrian Calls (#/hr)	10	10			5	5	5
Act Effct Green (s)	53.9	53.9	15.2	75.4		31.8	31.8
Actuated g/C Ratio	0.45	0.45	0.13	0.63		0.26	0.26
v/c Ratio	0.70	0.36	0.67	0.55		0.87	0.80
Control Delay	30.8	4.0	58.5	14.3		53.7	23.4
Queue Delay	0.3	0.0	0.0	0.0		0.0	0.0
Total Delay	31.1	4.0	58.5	14.3		53.7	23.4
LOS	C	A	E	B		D	C
Approach Delay	25.2			22.8		41.5	
Approach LOS	C			C		D	
Queue Length 50th (m)	92.0	0.0	28.1	69.3		76.5	33.1
Queue Length 95th (m)	121.0	14.9	39.6	86.1		97.6	75.1
Internal Link Dist (m)	145.1			247.7		324.5	
Turn Bay Length (m)		75.0	200.0				
Base Capacity (vph)	1420	787	480	1985		892	636
Starvation Cap Reductn	93	0	0	0		0	0
Spillback Cap Reductn	0	0	0	0		0	0
Storage Cap Reductn	0	0	0	0		0	0
Reduced v/c Ratio	0.75	0.36	0.54	0.55		0.82	0.78

Intersection Summary

Area Type: Other
 Cycle Length: 120
 Actuated Cycle Length: 120
 Offset: 43 (36%), Referenced to phase 2:EBT and 6:WBT, Start of Green
 Natural Cycle: 85
 Control Type: Actuated-Coordinated
 Maximum v/c Ratio: 0.87
 Intersection Signal Delay: 29.5
 Intersection LOS: C
 Intersection Capacity Utilization 74.7%
 ICU Level of Service D
 Analysis Period (min) 15

Splits and Phases: 3: Conroy & Walkley

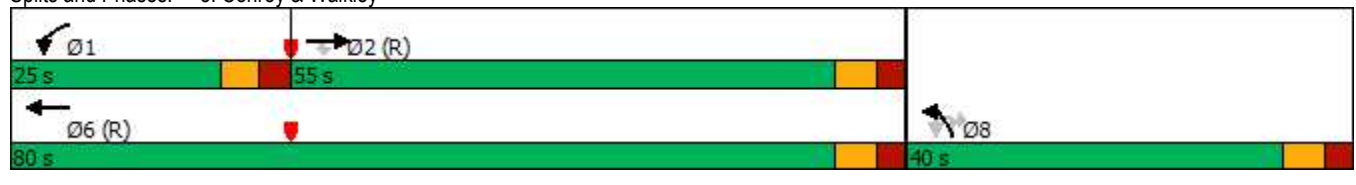

4: Conroy & St. Laurent
AM Peak Hour

2510 St. Laurent Boulevard
2029 Total Traffic

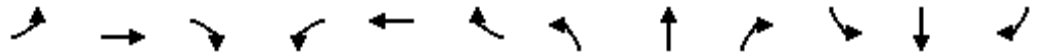

Lane Group	EBL	EBT	EBR	WBL	WBT	WBR	NBL	NBT	NBR	SBL	SBT	SBR
Lane Configurations												
Traffic Volume (vph)	15	69	88	63	46	25	195	1246	199	87	389	57
Future Volume (vph)	15	69	88	63	46	25	195	1246	199	87	389	57
Ideal Flow (vphpl)	1800	1800	1800	1800	1800	1800	1800	1800	1800	1800	1800	1800
Storage Length (m)	45.0		50.0	55.0		55.0	0.0		0.0	110.0		0.0
Storage Lanes	1		1	1		1	1		0	1		0
Taper Length (m)	40.0			40.0			10.0			25.0		
Lane Util. Factor	1.00	1.00	1.00	1.00	1.00	1.00	1.00	0.91	0.91	1.00	0.95	0.95
Ped Bike Factor	0.99		0.97	0.99		0.98	0.98	0.99		1.00	0.99	
Fr _t			0.850			0.850		0.979			0.981	
Fl _t Protected	0.950			0.950			0.950			0.950		
Satd. Flow (prot)	1353	1695	1427	1409	1589	1351	1642	4617	0	1674	3162	0
Fl _t Permitted	0.727			0.712			0.494			0.154		
Satd. Flow (perm)	1027	1695	1391	1044	1589	1322	835	4617	0	270	3162	0
Right Turn on Red			Yes			Yes			Yes			Yes
Satd. Flow (RTOR)			88			36		43			23	
Link Speed (k/h)		50			50			60			60	
Link Distance (m)		197.7			271.8			372.7			348.5	
Travel Time (s)		14.2			19.6			22.4			20.9	
Confl. Peds. (#/hr)	10		15	15		10	20		25	25		20
Confl. Bikes (#/hr)			3			3			3			25
Peak Hour Factor	1.00	1.00	1.00	1.00	1.00	1.00	1.00	1.00	1.00	1.00	1.00	1.00
Heavy Vehicles (%)	25%	5%	6%	20%	12%	12%	3%	2%	2%	1%	4%	3%
Adj. Flow (vph)	15	69	88	63	46	25	195	1246	199	87	389	57
Shared Lane Traffic (%)												
Lane Group Flow (vph)	15	69	88	63	46	25	195	1445	0	87	446	0
Enter Blocked Intersection	No	No	No	No	No	No	No	No	No	No	No	No
Lane Alignment	L NA	Left	R NA	L NA	Left	R NA	Left	Left	Right	L NA	Left	R NA
Median Width(m)		3.5			3.5			7.0			6.0	
Link Offset(m)		0.0			0.0			0.0			0.0	
Crosswalk Width(m)		5.0			5.0			5.0			5.0	
Two way Left Turn Lane												
Headway Factor	1.09	1.09	1.09	1.09	1.09	1.09	1.09	1.09	1.09	1.09	1.09	1.09
Turning Speed (k/h)	24		14	24		14	24		14	24		14
Number of Detectors	1	2	1	1	2	1	1	2		1	2	
Detector Template	Left	Thru	Right	Left	Thru	Right	Left	Thru		Left	Thru	
Leading Detector (m)	6.1	30.5	6.1	6.1	30.5	6.1	6.1	30.5		6.1	30.5	
Trailing Detector (m)	0.0	0.0	0.0	0.0	0.0	0.0	0.0	0.0		0.0	0.0	
Detector 1 Position(m)	0.0	0.0	0.0	0.0	0.0	0.0	0.0	0.0		0.0	0.0	
Detector 1 Size(m)	6.1	1.8	6.1	6.1	1.8	6.1	6.1	1.8		6.1	1.8	
Detector 1 Type	Cl+Ex	Cl+Ex	Cl+Ex	Cl+Ex	Cl+Ex	Cl+Ex	Cl+Ex	Cl+Ex		Cl+Ex	Cl+Ex	
Detector 1 Channel												
Detector 1 Extend (s)	0.0	0.0	0.0	0.0	0.0	0.0	0.0	0.0		0.0	0.0	
Detector 1 Queue (s)	0.0	0.0	0.0	0.0	0.0	0.0	0.0	0.0		0.0	0.0	
Detector 1 Delay (s)	0.0	0.0	0.0	0.0	0.0	0.0	0.0	0.0		0.0	0.0	
Detector 2 Position(m)		28.7			28.7			28.7			28.7	
Detector 2 Size(m)		1.8			1.8			1.8			1.8	
Detector 2 Type		Cl+Ex			Cl+Ex			Cl+Ex			Cl+Ex	
Detector 2 Channel												
Detector 2 Extend (s)		0.0			0.0			0.0			0.0	
Turn Type	Perm	NA	Perm	Perm	NA	Perm	Perm	NA		Perm	NA	
Protected Phases		4			8			2			6	
Permitted Phases	4		4	8		8	2			6		
Detector Phase	4	4	4	8	8	8	2	2		6	6	

4: Conroy & St. Laurent
AM Peak Hour

2510 St. Laurent Boulevard
2029 Total Traffic

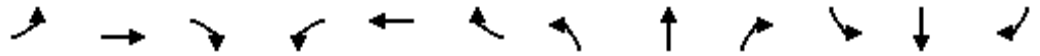

Lane Group	EBL	EBT	EBR	WBL	WBT	WBR	NBL	NBT	NBR	SBL	SBT	SBR
Switch Phase												
Minimum Initial (s)	10.0	10.0	10.0	10.0	10.0	10.0	10.0	10.0		10.0	10.0	
Minimum Split (s)	43.9	43.9	43.9	43.9	43.9	43.9	30.3	30.3		30.3	30.3	
Total Split (s)	44.0	44.0	44.0	44.0	44.0	44.0	56.0	56.0		56.0	56.0	
Total Split (%)	44.0%	44.0%	44.0%	44.0%	44.0%	44.0%	56.0%	56.0%		56.0%	56.0%	
Maximum Green (s)	37.1	37.1	37.1	37.1	37.1	37.1	49.7	49.7		49.7	49.7	
Yellow Time (s)	3.3	3.3	3.3	3.3	3.3	3.3	3.7	3.7		3.7	3.7	
All-Red Time (s)	3.6	3.6	3.6	3.6	3.6	3.6	2.6	2.6		2.6	2.6	
Lost Time Adjust (s)	0.0	0.0	0.0	0.0	0.0	0.0	0.0	0.0		0.0	0.0	
Total Lost Time (s)	6.9	6.9	6.9	6.9	6.9	6.9	6.3	6.3		6.3	6.3	
Lead/Lag												
Lead-Lag Optimize?												
Vehicle Extension (s)	3.0	3.0	3.0	3.0	3.0	3.0	3.0	3.0		3.0	3.0	
Recall Mode	None	None	None	None	None	None	C-Max	C-Max		C-Max	C-Max	
Walk Time (s)	7.0	7.0	7.0	7.0	7.0	7.0	7.0	7.0		7.0	7.0	
Flash Dont Walk (s)	30.0	30.0	30.0	30.0	30.0	30.0	17.0	17.0		17.0	17.0	
Pedestrian Calls (#/hr)	15	15	15	10	10	10	20	20		15	15	
Act Effct Green (s)	21.1	21.1	21.1	21.1	21.1	21.1	70.4	70.4		70.4	70.4	
Actuated g/C Ratio	0.21	0.21	0.21	0.21	0.21	0.21	0.70	0.70		0.70	0.70	
v/c Ratio	0.07	0.19	0.24	0.29	0.14	0.08	0.33	0.44		0.46	0.20	
Control Delay	24.1	28.4	7.0	31.8	27.7	5.2	13.3	10.6		26.2	8.7	
Queue Delay	0.0	0.0	0.0	0.0	0.0	0.0	0.0	0.0		0.0	0.0	
Total Delay	24.1	28.4	7.0	31.8	27.7	5.2	13.3	10.6		26.2	8.7	
LOS	C	C	A	C	C	A	B	B		C	A	
Approach Delay		17.1			25.5			10.9			11.5	
Approach LOS		B			C			B			B	
Queue Length 50th (m)	2.5	11.7	1.6	10.8	7.6	0.0	9.2	26.7		4.6	9.3	
Queue Length 95th (m)	m4.9	m16.7	9.4	16.1	12.1	3.5	40.3	77.6		#35.0	31.2	
Internal Link Dist (m)		173.7			247.8			348.7			324.5	
Turn Bay Length (m)	45.0		50.0	55.0		55.0				110.0		
Base Capacity (vph)	381	628	571	387	589	513	587	3261		190	2231	
Starvation Cap Reductn	0	0	0	0	0	0	0	0		0	0	
Spillback Cap Reductn	0	0	0	0	0	0	0	0		0	0	
Storage Cap Reductn	0	0	0	0	0	0	0	0		0	0	
Reduced v/c Ratio	0.04	0.11	0.15	0.16	0.08	0.05	0.33	0.44		0.46	0.20	

Intersection Summary

Area Type: Other
 Cycle Length: 100
 Actuated Cycle Length: 100
 Offset: 23 (23%), Referenced to phase 2:NBT and 6:SBTL, Start of Green
 Natural Cycle: 90
 Control Type: Actuated-Coordinated
 Maximum v/c Ratio: 0.46
 Intersection Signal Delay: 12.3 Intersection LOS: B
 Intersection Capacity Utilization 72.2% ICU Level of Service C
 Analysis Period (min) 15
 # 95th percentile volume exceeds capacity, queue may be longer.
 Queue shown is maximum after two cycles.
 m Volume for 95th percentile queue is metered by upstream signal.

Splits and Phases: 4: Conroy & St. Laurent

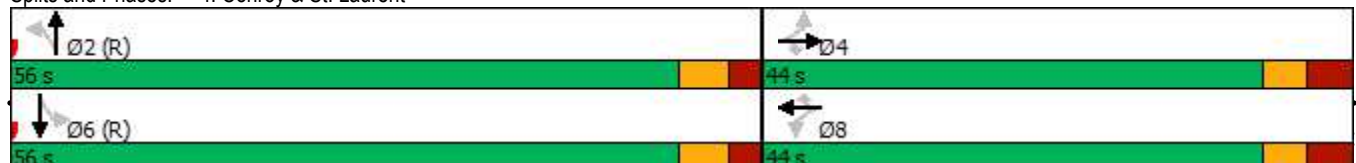



Lane Group	WBL	WBR	NBT	NBR	SBL	SBT
Lane Configurations						
Traffic Volume (vph)	75	59	71	22	101	176
Future Volume (vph)	75	59	71	22	101	176
Ideal Flow (vphpl)	1800	1800	1800	1800	1800	1800
Lane Util. Factor	1.00	1.00	1.00	1.00	1.00	1.00
Ped Bike Factor						
Frt	0.941		0.968			
Flt Protected	0.973					0.982
Satd. Flow (prot)	1547	0	1498	0	0	1669
Flt Permitted	0.973					0.982
Satd. Flow (perm)	1547	0	1498	0	0	1669
Link Speed (k/h)	50		50			50
Link Distance (m)	137.6		234.0			146.3
Travel Time (s)	9.9		16.8			10.5
Confl. Peds. (#/hr)				10	10	
Confl. Bikes (#/hr)		4		3		
Peak Hour Factor	1.00	1.00	1.00	1.00	1.00	1.00
Heavy Vehicles (%)	4%	7%	15%	15%	6%	4%
Adj. Flow (vph)	75	59	71	22	101	176
Shared Lane Traffic (%)						
Lane Group Flow (vph)	134	0	93	0	0	277
Enter Blocked Intersection	No	No	No	No	No	No
Lane Alignment	Left	Right	Left	Right	Left	Left
Median Width(m)	3.5		0.0			0.0
Link Offset(m)	0.0		0.0			0.0
Crosswalk Width(m)	2.0		10.0			10.0
Two way Left Turn Lane						
Headway Factor	1.09	1.09	1.09	1.09	1.09	1.09
Turning Speed (k/h)	24	14		14	24	
Sign Control	Stop		Free			Free

Intersection Summary

Area Type: Other

Control Type: Unsignalized

Intersection Capacity Utilization 37.2% ICU Level of Service A

Analysis Period (min) 15

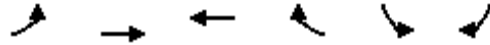

Lane Group	EBL	EBT	WBT	WBR	SBL	SBR
Lane Configurations						
Traffic Volume (vph)	0	128	135	5	13	0
Future Volume (vph)	0	128	135	5	13	0
Ideal Flow (vphpl)	1800	1800	1800	1800	1800	1800
Lane Util. Factor	1.00	1.00	1.00	1.00	1.00	1.00
Ped Bike Factor						
Frt	0.995					
Flt Protected					0.950	
Satd. Flow (prot)	0	1618	1615	0	1674	0
Flt Permitted					0.950	
Satd. Flow (perm)	0	1618	1615	0	1674	0
Link Speed (k/h)	50		50	50		
Link Distance (m)	40.4		197.7	90.8		
Travel Time (s)	2.9		14.2	6.5		
Confl. Peds. (#/hr)	10				10	
Confl. Bikes (#/hr)				3	3	
Peak Hour Factor	1.00	1.00	1.00	1.00	1.00	1.00
Heavy Vehicles (%)	1%	10%	10%	1%	1%	1%
Adj. Flow (vph)	0	128	135	5	13	0
Shared Lane Traffic (%)						
Lane Group Flow (vph)	0	128	140	0	13	0
Enter Blocked Intersection	No	No	No	No	No	No
Lane Alignment	Left	Left	Left	Right	Left	Right
Median Width(m)	0.0		3.5	3.5		
Link Offset(m)	0.0		0.0	0.0		
Crosswalk Width(m)	0.0		0.0	5.0		
Two way Left Turn Lane						
Headway Factor	1.09	1.09	1.09	1.09	1.09	1.09
Turning Speed (k/h)	24				14	24
Sign Control	Free		Free	Stop		

Intersection Summary

Area Type: Other

Control Type: Unsignalized

Intersection Capacity Utilization 19.4% ICU Level of Service A

Analysis Period (min) 15

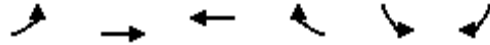

Lane Group	EBL	EBT	WBT	WBR	SBL	SBR
Lane Configurations						
Traffic Volume (vph)	0	123	133	2	5	1
Future Volume (vph)	0	123	133	2	5	1
Ideal Flow (vphpl)	1800	1800	1800	1800	1800	1800
Lane Util. Factor	1.00	1.00	1.00	1.00	1.00	1.00
Ped Bike Factor						
Frts			0.998		0.977	
Flt Protected					0.960	
Satd. Flow (prot)	0	1618	1617	0	1653	0
Flt Permitted					0.960	
Satd. Flow (perm)	0	1618	1617	0	1653	0
Link Speed (k/h)		50	50		50	
Link Distance (m)		137.6	40.4		92.1	
Travel Time (s)		9.9	2.9		6.6	
Confl. Peds. (#/hr)	10			10		
Confl. Bikes (#/hr)				3		3
Peak Hour Factor	1.00	1.00	1.00	1.00	1.00	1.00
Heavy Vehicles (%)	1%	10%	10%	1%	1%	1%
Adj. Flow (vph)	0	123	133	2	5	1
Shared Lane Traffic (%)						
Lane Group Flow (vph)	0	123	135	0	6	0
Enter Blocked Intersection	No	No	No	No	No	No
Lane Alignment	Left	Left	Left	Right	Left	Right
Median Width(m)		0.0	0.0		3.5	
Link Offset(m)		0.0	0.0		0.0	
Crosswalk Width(m)		0.0	0.0		5.0	
Two way Left Turn Lane						
Headway Factor	1.09	1.09	1.09	1.09	1.09	1.09
Turning Speed (k/h)	24			14	24	14
Sign Control		Free	Free		Stop	

Intersection Summary

Area Type:	Other
Control Type:	Unsignalized
Intersection Capacity Utilization	19.2%
ICU Level of Service	A
Analysis Period (min)	15



Lane Group	WBL	WBR	NBT	NBR	SBL	SBT
Lane Configurations						
Traffic Volume (vph)	1	15	139	1	6	252
Future Volume (vph)	1	15	139	1	6	252
Ideal Flow (vphpl)	1800	1800	1800	1800	1800	1800
Lane Util. Factor	1.00	1.00	1.00	1.00	1.00	1.00
Ped Bike Factor						
Frt	0.873		0.999			
Flt Protected	0.997					0.999
Satd. Flow (prot)	1534	0	1618	0	0	1695
Flt Permitted	0.997					0.999
Satd. Flow (perm)	1534	0	1618	0	0	1695
Link Speed (k/h)	50		50			50
Link Distance (m)	105.3		30.4			100.3
Travel Time (s)	7.6		2.2			7.2
Confl. Peds. (#/hr)				10	10	
Confl. Bikes (#/hr)		3		3		
Peak Hour Factor	1.00	1.00	1.00	1.00	1.00	1.00
Heavy Vehicles (%)	1%	1%	10%	1%	1%	5%
Adj. Flow (vph)	1	15	139	1	6	252
Shared Lane Traffic (%)						
Lane Group Flow (vph)	16	0	140	0	0	258
Enter Blocked Intersection	No	No	No	No	No	No
Lane Alignment	Left	Right	Left	Right	Left	Left
Median Width(m)	3.5		3.5			3.5
Link Offset(m)	0.0		0.0			0.0
Crosswalk Width(m)	5.0		0.0			0.0
Two way Left Turn Lane						
Headway Factor	1.09	1.09	1.09	1.09	1.09	1.09
Turning Speed (k/h)	24	14		14	24	
Sign Control	Stop		Free			Free

Intersection Summary

Area Type: Other

Control Type: Unsignalized

Intersection Capacity Utilization 29.1% ICU Level of Service A

Analysis Period (min) 15

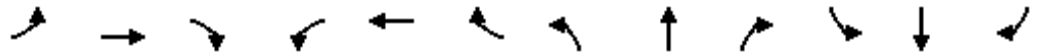

Lane Group	EBL	EBT	EBR	WBL	WBT	WBR	NBL	NBT	NBR	SBL	SBT	SBR
Lane Configurations												
Traffic Volume (vph)	27	1557	119	27	1626	70	177	5	78	92	104	50
Future Volume (vph)	27	1557	119	27	1626	70	177	5	78	92	104	50
Ideal Flow (vphpl)	1800	1800	1800	1800	1800	1800	1800	1800	1800	1800	1800	1800
Storage Length (m)	40.0		0.0	50.0		0.0	35.0		0.0	30.0		0.0
Storage Lanes	1		0	1		0	1		0	1		0
Taper Length (m)	25.0			30.0			25.0			30.0		
Lane Util. Factor	1.00	0.95	0.95	1.00	0.95	0.95	1.00	1.00	1.00	1.00	1.00	1.00
Ped Bike Factor		1.00			1.00		1.00	0.98		1.00	0.99	
Frt		0.989			0.994			0.859			0.951	
Flt Protected	0.950			0.950			0.950			0.950		
Satd. Flow (prot)	1674	3234	0	1674	3293	0	1674	1472	0	1674	1651	0
Flt Permitted	0.089			0.093			0.600			0.703		
Satd. Flow (perm)	157	3234	0	164	3293	0	1053	1472	0	1233	1651	0
Right Turn on Red			Yes			Yes			Yes			Yes
Satd. Flow (RTOR)		13			7			34			22	
Link Speed (k/h)		50			50			50			50	
Link Distance (m)		402.0			171.1			100.3			281.0	
Travel Time (s)		28.9			12.3			7.2			20.2	
Confl. Peds. (#/hr)	5		20	20		5	5		5	5		5
Confl. Bikes (#/hr)			5			3			3			
Peak Hour Factor	1.00	1.00	1.00	1.00	1.00	1.00	1.00	1.00	1.00	1.00	1.00	1.00
Heavy Vehicles (%)	1%	3%	3%	1%	2%	1%	1%	1%	2%	1%	1%	4%
Adj. Flow (vph)	27	1557	119	27	1626	70	177	5	78	92	104	50
Shared Lane Traffic (%)												
Lane Group Flow (vph)	27	1676	0	27	1696	0	177	83	0	92	154	0
Enter Blocked Intersection	No	No	No	No	No	No	No	No	No	No	No	No
Lane Alignment	L NA	Left	R NA	Left	Left	Right	L NA	Left	R NA	L NA	Left	R NA
Median Width(m)		5.0			5.0			3.5			3.5	
Link Offset(m)		0.0			0.0			0.0			0.0	
Crosswalk Width(m)		5.0			5.0			5.0			5.0	
Two way Left Turn Lane												
Headway Factor	1.09	1.09	1.09	1.09	1.09	1.09	1.09	1.09	1.09	1.09	1.09	1.09
Turning Speed (k/h)	24		14	24		14	24		14	24		14
Number of Detectors	1	2		1	2		1	2		1	2	
Detector Template	Left	Thru		Left	Thru		Left	Thru		Left	Thru	
Leading Detector (m)	6.1	30.5		6.1	30.5		6.1	30.5		6.1	30.5	
Trailing Detector (m)	0.0	0.0		0.0	0.0		0.0	0.0		0.0	0.0	
Detector 1 Position(m)	0.0	0.0		0.0	0.0		0.0	0.0		0.0	0.0	
Detector 1 Size(m)	6.1	1.8		6.1	1.8		6.1	1.8		6.1	1.8	
Detector 1 Type	Cl+Ex	Cl+Ex		Cl+Ex	Cl+Ex		Cl+Ex	Cl+Ex		Cl+Ex	Cl+Ex	
Detector 1 Channel												
Detector 1 Extend (s)	0.0	0.0		0.0	0.0		0.0	0.0		0.0	0.0	
Detector 1 Queue (s)	0.0	0.0		0.0	0.0		0.0	0.0		0.0	0.0	
Detector 1 Delay (s)	0.0	0.0		0.0	0.0		0.0	0.0		0.0	0.0	
Detector 2 Position(m)		28.7			28.7			28.7			28.7	
Detector 2 Size(m)		1.8			1.8			1.8			1.8	
Detector 2 Type		Cl+Ex			Cl+Ex			Cl+Ex			Cl+Ex	
Detector 2 Channel												
Detector 2 Extend (s)		0.0			0.0			0.0			0.0	
Turn Type	Perm	NA		Perm	NA		Perm	NA		Perm	NA	
Protected Phases		2			6			8			4	
Permitted Phases	2			6			8			4		
Detector Phase	2	2		6	6		8	8		4	4	

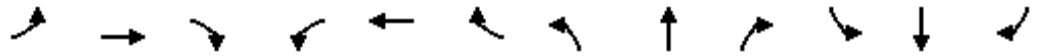

Lane Group	EBL	EBT	EBR	WBL	WBT	WBR	NBL	NBT	NBR	SBL	SBT	SBR
Switch Phase												
Minimum Initial (s)	10.0	10.0		10.0	10.0		10.0	10.0		10.0	10.0	
Minimum Split (s)	35.9	35.9		35.9	35.9		36.2	36.2		36.2	36.2	
Total Split (s)	74.0	74.0		74.0	74.0		36.0	36.0		36.0	36.0	
Total Split (%)	67.3%	67.3%		67.3%	67.3%		32.7%	32.7%		32.7%	32.7%	
Maximum Green (s)	68.1	68.1		68.1	68.1		29.8	29.8		29.8	29.8	
Yellow Time (s)	3.3	3.3		3.3	3.3		3.3	3.3		3.3	3.3	
All-Red Time (s)	2.6	2.6		2.6	2.6		2.9	2.9		2.9	2.9	
Lost Time Adjust (s)	0.0	0.0		0.0	0.0		0.0	0.0		0.0	0.0	
Total Lost Time (s)	5.9	5.9		5.9	5.9		6.2	6.2		6.2	6.2	
Lead/Lag												
Lead-Lag Optimize?												
Vehicle Extension (s)	3.0	3.0		3.0	3.0		3.0	3.0		3.0	3.0	
Recall Mode	C-Max	C-Max		C-Max	C-Max		None	None		None	None	
Walk Time (s)	15.0	15.0		15.0	15.0		10.0	10.0		10.0	10.0	
Flash Dont Walk (s)	15.0	15.0		15.0	15.0		20.0	20.0		20.0	20.0	
Pedestrian Calls (#/hr)	10	10		5	5		5	5		5	5	
Act Effct Green (s)	75.6	75.6		75.6	75.6		22.3	22.3		22.3	22.3	
Actuated g/C Ratio	0.69	0.69		0.69	0.69		0.20	0.20		0.20	0.20	
v/c Ratio	0.25	0.75		0.24	0.75		0.83	0.26		0.37	0.44	
Control Delay	16.0	15.1		10.9	11.7		71.0	23.1		40.2	35.1	
Queue Delay	0.0	0.0		0.0	0.0		0.0	0.0		0.0	0.0	
Total Delay	16.0	15.1		10.9	11.7		71.0	23.1		40.2	35.1	
LOS	B	B		B	B		E	C		D	D	
Approach Delay		15.1			11.7			55.7			37.0	
Approach LOS		B			B			E			D	
Queue Length 50th (m)	1.8	102.3		1.7	144.8		33.5	8.0		15.7	22.7	
Queue Length 95th (m)	8.4	158.6		m2.3	50.6		52.9	18.5		27.3	37.3	
Internal Link Dist (m)		378.0			147.1			76.3			257.0	
Turn Bay Length (m)	40.0			50.0			35.0			30.0		
Base Capacity (vph)	107	2226		112	2265		285	423		334	463	
Starvation Cap Reductn	0	0		0	4		0	0		0	0	
Spillback Cap Reductn	0	0		0	0		0	0		0	0	
Storage Cap Reductn	0	0		0	0		0	0		0	0	
Reduced v/c Ratio	0.25	0.75		0.24	0.75		0.62	0.20		0.28	0.33	

Intersection Summary

Area Type: Other
 Cycle Length: 110
 Actuated Cycle Length: 110
 Offset: 20 (18%), Referenced to phase 2:EBTL and 6:WBTL, Start of Green
 Natural Cycle: 90
 Control Type: Actuated-Coordinated
 Maximum v/c Ratio: 0.83
 Intersection Signal Delay: 17.7
 Intersection LOS: B
 Intersection Capacity Utilization 87.0%
 ICU Level of Service E
 Analysis Period (min) 15
 m Volume for 95th percentile queue is metered by upstream signal.

Splits and Phases: 1: Don Reid/Ryder & Walkley

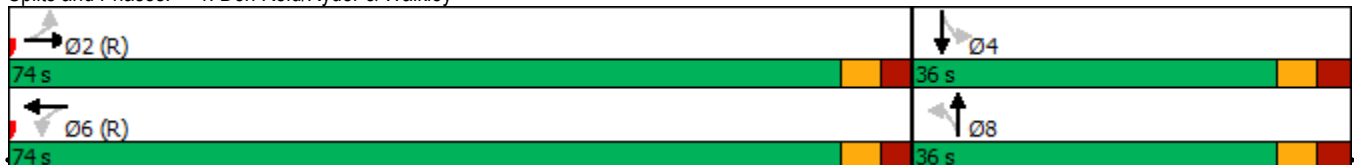



Lane Group	EBT	EBR	WBL	WBT	NBL	NBR
Lane Configurations	↑↑	↗	↖	↑↑	↖	↗
Traffic Volume (vph)	1749	64	36	1659	49	41
Future Volume (vph)	1749	64	36	1659	49	41
Ideal Flow (vphpl)	1800	1800	1800	1800	1800	1800
Storage Length (m)		20.0	65.0		30.0	0.0
Storage Lanes		1	1		1	1
Taper Length (m)			25.0		30.0	
Lane Util. Factor	0.95	1.00	1.00	0.95	1.00	1.00
Ped Bike Factor		0.95	1.00		0.99	0.98
Fr _t		0.850				0.850
Fl _t Protected			0.950		0.950	
Satd. Flow (prot)	3252	1483	1642	3316	1658	1483
Fl _t Permitted			0.109		0.950	
Satd. Flow (perm)	3252	1413	188	3316	1646	1455
Right Turn on Red		Yes				Yes
Satd. Flow (RTOR)		28				32
Link Speed (k/h)	50			50	50	
Link Distance (m)	171.1			169.1	128.6	
Travel Time (s)	12.3			12.2	9.3	
Confl. Peds. (#/hr)		15	15		5	5
Confl. Bikes (#/hr)		3				
Peak Hour Factor	1.00	1.00	1.00	1.00	1.00	1.00
Heavy Vehicles (%)	4%	2%	3%	2%	2%	2%
Adj. Flow (vph)	1749	64	36	1659	49	41
Shared Lane Traffic (%)						
Lane Group Flow (vph)	1749	64	36	1659	49	41
Enter Blocked Intersection	No	No	No	No	No	No
Lane Alignment	Left	Right	L NA	Left	L NA	R NA
Median Width(m)	3.5			5.0	3.5	
Link Offset(m)	0.0			0.0	0.0	
Crosswalk Width(m)	5.0			5.0	5.0	
Two way Left Turn Lane						
Headway Factor	1.09	1.09	1.09	1.09	1.09	1.09
Turning Speed (k/h)		14	24		24	14
Number of Detectors	2	1	1	2	1	1
Detector Template	Thru	Right	Left	Thru	Left	Right
Leading Detector (m)	30.5	6.1	6.1	30.5	6.1	6.1
Trailing Detector (m)	0.0	0.0	0.0	0.0	0.0	0.0
Detector 1 Position(m)	0.0	0.0	0.0	0.0	0.0	0.0
Detector 1 Size(m)	1.8	6.1	6.1	1.8	6.1	6.1
Detector 1 Type	Cl+Ex	Cl+Ex	Cl+Ex	Cl+Ex	Cl+Ex	Cl+Ex
Detector 1 Channel						
Detector 1 Extend (s)	0.0	0.0	0.0	0.0	0.0	0.0
Detector 1 Queue (s)	0.0	0.0	0.0	0.0	0.0	0.0
Detector 1 Delay (s)	0.0	0.0	0.0	0.0	0.0	0.0
Detector 2 Position(m)	28.7			28.7		
Detector 2 Size(m)	1.8			1.8		
Detector 2 Type	Cl+Ex			Cl+Ex		
Detector 2 Channel						
Detector 2 Extend (s)	0.0			0.0		
Turn Type	NA	Perm	Perm	NA	Prot	Perm
Protected Phases	2			6	8	
Permitted Phases		2	6			8
Detector Phase	2	2	6	6	8	8

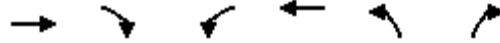







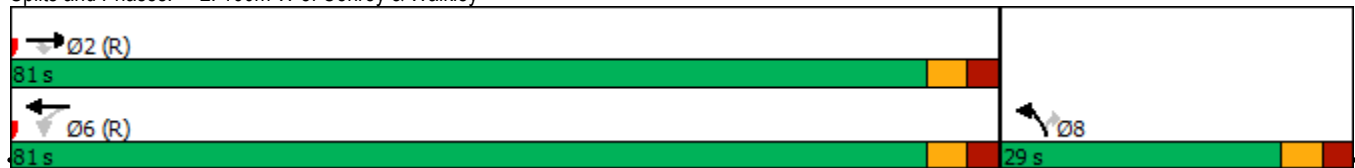

Lane Group	EBT	EBR	WBL	WBT	NBL	NBR
Switch Phase						
Minimum Initial (s)	10.0	10.0	10.0	10.0	5.0	5.0
Minimum Split (s)	37.0	37.0	37.0	37.0	29.0	29.0
Total Split (s)	81.0	81.0	81.0	81.0	29.0	29.0
Total Split (%)	73.6%	73.6%	73.6%	73.6%	26.4%	26.4%
Maximum Green (s)	75.0	75.0	75.0	75.0	23.0	23.0
Yellow Time (s)	3.3	3.3	3.3	3.3	3.3	3.3
All-Red Time (s)	2.7	2.7	2.7	2.7	2.7	2.7
Lost Time Adjust (s)	0.0	0.0	0.0	0.0	0.0	0.0
Total Lost Time (s)	6.0	6.0	6.0	6.0	6.0	6.0
Lead/Lag						
Lead-Lag Optimize?						
Vehicle Extension (s)	3.0	3.0	3.0	3.0	3.0	3.0
Recall Mode	C-Max	C-Max	C-Max	C-Max	None	None
Walk Time (s)	18.0	18.0			7.0	7.0
Flash Dont Walk (s)	13.0	13.0			16.0	16.0
Pedestrian Calls (#/hr)	5	5			5	5
Act Effct Green (s)	90.6	90.6	90.6	90.6	10.9	10.9
Actuated g/C Ratio	0.82	0.82	0.82	0.82	0.10	0.10
v/c Ratio	0.65	0.05	0.23	0.61	0.30	0.24
Control Delay	2.3	0.8	9.4	7.6	48.0	20.9
Queue Delay	0.1	0.0	0.0	0.1	0.0	0.0
Total Delay	2.4	0.8	9.4	7.7	48.0	20.9
LOS	A	A	A	A	D	C
Approach Delay	2.4			7.8	35.6	
Approach LOS	A			A	D	
Queue Length 50th (m)	16.8	0.1	0.6	75.4	9.4	1.7
Queue Length 95th (m)	23.4	m0.6	m7.5	143.2	17.5	9.7
Internal Link Dist (m)	147.1			145.1	104.6	
Turn Bay Length (m)		20.0	65.0		30.0	
Base Capacity (vph)	2679	1169	155	2731	346	329
Starvation Cap Reductn	89	0	0	267	0	0
Spillback Cap Reductn	200	0	0	14	0	1
Storage Cap Reductn	0	0	0	0	0	0
Reduced v/c Ratio	0.71	0.05	0.23	0.67	0.14	0.13

Intersection Summary

Area Type: Other
 Cycle Length: 110
 Actuated Cycle Length: 110
 Offset: 25 (23%), Referenced to phase 2:EBT and 6:WBTL, Start of Green
 Natural Cycle: 80
 Control Type: Actuated-Coordinated
 Maximum v/c Ratio: 0.65
 Intersection Signal Delay: 5.7
 Intersection LOS: A
 Intersection Capacity Utilization 67.5%
 ICU Level of Service C
 Analysis Period (min) 15
 m Volume for 95th percentile queue is metered by upstream signal.

Splits and Phases: 2: 160m W of Conroy & Walkley



							
Lane Group	EBT	EBR	WBL	WBT	NBU	NBL	NBR
Lane Configurations	↑↑	↑	↑↑	↑↑		↑↑	↑
Traffic Volume (vph)	1319	474	545	1180	45	484	334
Future Volume (vph)	1319	474	545	1180	45	484	334
Ideal Flow (vphpl)	1800	1800	1800	1800	1800	1800	1800
Storage Length (m)		75.0	200.0			0.0	0.0
Storage Lanes		1	2			2	1
Taper Length (m)			50.0			10.0	
Lane Util. Factor	0.95	1.00	0.97	0.95	0.95	0.97	1.00
Ped Bike Factor		0.95	0.99				0.96
Frt		0.850					0.850
Flt Protected			0.950			0.950	
Satd. Flow (prot)	3221	1483	3185	3349	0	3248	1469
Flt Permitted			0.950			0.950	
Satd. Flow (perm)	3221	1414	3157	3349	0	3248	1406
Right Turn on Red		Yes					Yes
Satd. Flow (RTOR)		440					334
Link Speed (k/h)	50			50		60	
Link Distance (m)	169.1			271.7		348.5	
Travel Time (s)	12.2			19.6		20.9	
Confl. Peds. (#/hr)		30	30				20
Confl. Bikes (#/hr)		4					4
Peak Hour Factor	1.00	1.00	1.00	1.00	1.00	1.00	1.00
Heavy Vehicles (%)	5%	2%	3%	1%	1%	1%	3%
Adj. Flow (vph)	1319	474	545	1180	45	484	334
Shared Lane Traffic (%)							
Lane Group Flow (vph)	1319	474	545	1180	0	529	334
Enter Blocked Intersection	No	No	No	No	No	No	No
Lane Alignment	Left	R NA	Left	Left	R NA	L NA	R NA
Median Width(m)	7.0			9.0		10.5	
Link Offset(m)	0.0			0.0		0.0	
Crosswalk Width(m)	5.0			5.0		5.0	
Two way Left Turn Lane							
Headway Factor	1.09	1.09	1.09	1.09	1.09	1.09	1.09
Turning Speed (k/h)		14	24		14	24	14
Number of Detectors	2	1	1	2	1	1	1
Detector Template	Thru	Right	Left	Thru	Left	Left	Right
Leading Detector (m)	30.5	6.1	6.1	30.5	6.1	6.1	6.1
Trailing Detector (m)	0.0	0.0	0.0	0.0	0.0	0.0	0.0
Detector 1 Position(m)	0.0	0.0	0.0	0.0	0.0	0.0	0.0
Detector 1 Size(m)	1.8	6.1	6.1	1.8	6.1	6.1	6.1
Detector 1 Type	Cl+Ex	Cl+Ex	Cl+Ex	Cl+Ex	Cl+Ex	Cl+Ex	Cl+Ex
Detector 1 Channel							
Detector 1 Extend (s)	0.0	0.0	0.0	0.0	0.0	0.0	0.0
Detector 1 Queue (s)	0.0	0.0	0.0	0.0	0.0	0.0	0.0
Detector 1 Delay (s)	0.0	0.0	0.0	0.0	0.0	0.0	0.0
Detector 2 Position(m)	28.7			28.7			
Detector 2 Size(m)	1.8			1.8			
Detector 2 Type	Cl+Ex			Cl+Ex			
Detector 2 Channel							
Detector 2 Extend (s)	0.0			0.0			
Turn Type	NA	Perm	Prot	NA	Perm	Prot	Perm
Protected Phases	2		1	6		8	
Permitted Phases		2			8		8
Detector Phase	2	2	1	6	8	8	8



Lane Group	EBT	EBR	WBL	WBT	NBU	NBL	NBR
Switch Phase							
Minimum Initial (s)	10.0	10.0	5.0	10.0	5.0	5.0	5.0
Minimum Split (s)	36.4	36.4	16.0	24.7	30.4	30.4	30.4
Total Split (s)	51.0	51.0	28.0	79.0	31.0	31.0	31.0
Total Split (%)	46.4%	46.4%	25.5%	71.8%	28.2%	28.2%	28.2%
Maximum Green (s)	44.6	44.6	21.8	72.6	24.6	24.6	24.6
Yellow Time (s)	3.7	3.7	3.3	3.7	3.7	3.7	3.7
All-Red Time (s)	2.7	2.7	2.9	2.7	2.7	2.7	2.7
Lost Time Adjust (s)	0.0	0.0	0.0	0.0		0.0	0.0
Total Lost Time (s)	6.4	6.4	6.2	6.4		6.4	6.4
Lead/Lag	Lag	Lag	Lead				
Lead-Lag Optimize?	Yes	Yes	Yes				
Vehicle Extension (s)	3.0	3.0	3.0	3.0	3.0	3.0	3.0
Recall Mode	C-Max	C-Max	None	C-Max	None	None	None
Walk Time (s)	10.0	10.0			7.0	7.0	7.0
Flash Dont Walk (s)	20.0	20.0			17.0	17.0	17.0
Pedestrian Calls (#/hr)	20	20			15	15	15
Act Effct Green (s)	47.2	47.2	21.5	74.8		22.4	22.4
Actuated g/C Ratio	0.43	0.43	0.20	0.68		0.20	0.20
v/c Ratio	0.96	0.55	0.88	0.52		0.80	0.61
Control Delay	43.5	8.3	59.4	10.0		51.5	9.1
Queue Delay	0.0	0.2	0.0	0.0		0.0	0.0
Total Delay	43.5	8.5	59.4	10.0		51.5	9.1
LOS	D	A	E	B		D	A
Approach Delay	34.2			25.6		35.1	
Approach LOS	C			C		D	
Queue Length 50th (m)	~112.0	4.2	53.6	56.9		50.8	0.0
Queue Length 95th (m)	#181.2	40.3	#79.3	73.0		67.3	21.9
Internal Link Dist (m)	145.1			247.7		324.5	
Turn Bay Length (m)		75.0	200.0				
Base Capacity (vph)	1380	857	638	2278		726	573
Starvation Cap Reductn	0	57	0	0		0	0
Spillback Cap Reductn	0	0	0	108		0	0
Storage Cap Reductn	0	0	0	0		0	0
Reduced v/c Ratio	0.96	0.59	0.85	0.54		0.73	0.58

Intersection Summary

Area Type: Other
 Cycle Length: 110
 Actuated Cycle Length: 110
 Offset: 20 (18%), Referenced to phase 2:EBT and 6:WBT, Start of Green
 Natural Cycle: 95
 Control Type: Actuated-Coordinated
 Maximum v/c Ratio: 0.96
 Intersection Signal Delay: 31.0 Intersection LOS: C
 Intersection Capacity Utilization 88.6% ICU Level of Service E
 Analysis Period (min) 15
 ~ Volume exceeds capacity, queue is theoretically infinite.
 Queue shown is maximum after two cycles.
 # 95th percentile volume exceeds capacity, queue may be longer.
 Queue shown is maximum after two cycles.

Splits and Phases: 3: Conroy & Walkley



4: Conroy & St. Laurent
PM Peak Hour

2510 St. Laurent Boulevard
2029 Total Traffic

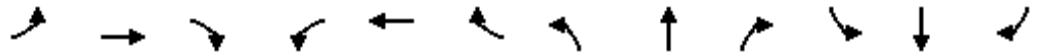

Lane Group	EBL	EBT	EBR	WBL	WBT	WBR	NBL	NBT	NBR	SBL	SBT	SBR
Lane Configurations												
Traffic Volume (vph)	47	81	322	232	38	102	47	595	81	37	1111	21
Future Volume (vph)	47	81	322	232	38	102	47	595	81	37	1111	21
Ideal Flow (vphpl)	1800	1800	1800	1800	1800	1800	1800	1800	1800	1800	1800	1800
Storage Length (m)	45.0		50.0	55.0		55.0	0.0		0.0	110.0		0.0
Storage Lanes	1		1	1		1	1		0	1		0
Taper Length (m)	40.0			40.0			10.0			25.0		
Lane Util. Factor	1.00	1.00	1.00	1.00	1.00	1.00	1.00	0.91	0.91	1.00	0.95	0.95
Ped Bike Factor	0.99		0.98	0.99		0.98		0.99		0.99	1.00	
Fr			0.850			0.850		0.982			0.997	
Flt Protected	0.950			0.950			0.950			0.950		
Satd. Flow (prot)	1674	1728	1483	1642	1618	1483	1642	4610	0	1537	3296	0
Flt Permitted	0.732			0.555			0.151			0.370		
Satd. Flow (perm)	1281	1728	1452	953	1618	1453	261	4610	0	590	3296	0
Right Turn on Red			Yes			Yes			Yes			Yes
Satd. Flow (RTOR)			121			73		27			2	
Link Speed (k/h)		50			50			60			60	
Link Distance (m)		197.7			271.8			372.7			348.5	
Travel Time (s)		14.2			19.6			22.4			20.9	
Confl. Peds. (#/hr)	10		10	10		10	10		20	20		10
Confl. Bikes (#/hr)			3			3			5			14
Peak Hour Factor	1.00	1.00	1.00	1.00	1.00	1.00	1.00	1.00	1.00	1.00	1.00	1.00
Heavy Vehicles (%)	1%	3%	2%	3%	10%	2%	3%	2%	8%	10%	2%	12%
Adj. Flow (vph)	47	81	322	232	38	102	47	595	81	37	1111	21
Shared Lane Traffic (%)												
Lane Group Flow (vph)	47	81	322	232	38	102	47	676	0	37	1132	0
Enter Blocked Intersection	No	No	No	No	No	No	No	No	No	No	No	No
Lane Alignment	L NA	Left	R NA	L NA	Left	R NA	Left	Left	Right	L NA	Left	R NA
Median Width(m)		3.5			3.5			7.0			6.0	
Link Offset(m)		0.0			0.0			0.0			0.0	
Crosswalk Width(m)		5.0			5.0			5.0			5.0	
Two way Left Turn Lane												
Headway Factor	1.09	1.09	1.09	1.09	1.09	1.09	1.09	1.09	1.09	1.09	1.09	1.09
Turning Speed (k/h)	24		14	24		14	24		14	24		14
Number of Detectors	1	2	1	1	2	1	1	2		1	2	
Detector Template	Left	Thru	Right	Left	Thru	Right	Left	Thru		Left	Thru	
Leading Detector (m)	6.1	30.5	6.1	6.1	30.5	6.1	6.1	30.5		6.1	30.5	
Trailing Detector (m)	0.0	0.0	0.0	0.0	0.0	0.0	0.0	0.0		0.0	0.0	
Detector 1 Position(m)	0.0	0.0	0.0	0.0	0.0	0.0	0.0	0.0		0.0	0.0	
Detector 1 Size(m)	6.1	1.8	6.1	6.1	1.8	6.1	6.1	1.8		6.1	1.8	
Detector 1 Type	Cl+Ex	Cl+Ex	Cl+Ex	Cl+Ex	Cl+Ex	Cl+Ex	Cl+Ex	Cl+Ex		Cl+Ex	Cl+Ex	
Detector 1 Channel												
Detector 1 Extend (s)	0.0	0.0	0.0	0.0	0.0	0.0	0.0	0.0		0.0	0.0	
Detector 1 Queue (s)	0.0	0.0	0.0	0.0	0.0	0.0	0.0	0.0		0.0	0.0	
Detector 1 Delay (s)	0.0	0.0	0.0	0.0	0.0	0.0	0.0	0.0		0.0	0.0	
Detector 2 Position(m)		28.7			28.7			28.7			28.7	
Detector 2 Size(m)		1.8			1.8			1.8			1.8	
Detector 2 Type		Cl+Ex			Cl+Ex			Cl+Ex			Cl+Ex	
Detector 2 Channel												
Detector 2 Extend (s)		0.0			0.0			0.0			0.0	
Turn Type	Perm	NA	Perm	pm+pt	NA	Perm	Perm	NA		Perm	NA	
Protected Phases		4		3	8			2			6	
Permitted Phases	4		4	8		8	2			6		
Detector Phase	4	4	4	3	8	8	2	2		6	6	

4: Conroy & St. Laurent
PM Peak Hour

2510 St. Laurent Boulevard
2029 Total Traffic

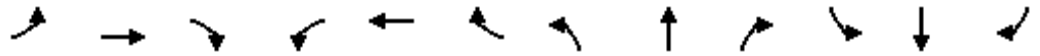

Lane Group	EBL	EBT	EBR	WBL	WBT	WBR	NBL	NBT	NBR	SBL	SBT	SBR
Switch Phase												
Minimum Initial (s)	10.0	10.0	10.0	5.0	10.0	10.0	10.0	10.0		10.0	10.0	
Minimum Split (s)	43.9	43.9	43.9	11.3	43.9	43.9	30.3	30.3		30.3	30.3	
Total Split (s)	44.0	44.0	44.0	15.0	59.0	59.0	36.0	36.0		36.0	36.0	
Total Split (%)	46.3%	46.3%	46.3%	15.8%	62.1%	62.1%	37.9%	37.9%		37.9%	37.9%	
Maximum Green (s)	37.1	37.1	37.1	9.3	52.1	52.1	29.7	29.7		29.7	29.7	
Yellow Time (s)	3.3	3.3	3.3	3.3	3.3	3.3	3.7	3.7		3.7	3.7	
All-Red Time (s)	3.6	3.6	3.6	2.4	3.6	3.6	2.6	2.6		2.6	2.6	
Lost Time Adjust (s)	0.0	0.0	0.0	0.0	0.0	0.0	0.0	0.0		0.0	0.0	
Total Lost Time (s)	6.9	6.9	6.9	5.7	6.9	6.9	6.3	6.3		6.3	6.3	
Lead/Lag	Lag	Lag	Lag	Lead								
Lead-Lag Optimize?	Yes	Yes	Yes	Yes								
Vehicle Extension (s)	3.0	3.0	3.0	3.0	3.0	3.0	3.0	3.0		3.0	3.0	
Recall Mode	None	None	None	None	None	None	C-Max	C-Max		C-Max	C-Max	
Walk Time (s)	7.0	7.0	7.0		7.0	7.0	7.0	7.0		7.0	7.0	
Flash Dont Walk (s)	30.0	30.0	30.0		30.0	30.0	17.0	17.0		17.0	17.0	
Pedestrian Calls (#/hr)	5	5	5		5	5	10	10		10	10	
Act Effct Green (s)	21.2	21.2	21.2	37.4	36.2	36.2	45.6	45.6		45.6	45.6	
Actuated g/C Ratio	0.22	0.22	0.22	0.39	0.38	0.38	0.48	0.48		0.48	0.48	
v/c Ratio	0.16	0.21	0.77	0.52	0.06	0.17	0.38	0.30		0.13	0.72	
Control Delay	26.7	27.8	32.3	23.2	15.2	6.0	33.9	16.8		20.3	25.5	
Queue Delay	0.0	0.0	0.0	0.0	0.0	0.0	0.0	0.0		0.0	0.0	
Total Delay	26.7	27.8	32.3	23.2	15.2	6.0	33.9	16.8		20.3	25.5	
LOS	C	C	C	C	B	A	C	B		C	C	
Approach Delay		30.9			17.7			17.9			25.4	
Approach LOS		C			B			B			C	
Queue Length 50th (m)	6.6	11.5	33.1	28.1	4.1	3.1	4.6	22.4		3.2	73.5	
Queue Length 95th (m)	11.5	17.2	47.0	30.7	6.9	8.7	#22.3	42.1		12.1	#151.6	
Internal Link Dist (m)		173.7			247.8			348.7			324.5	
Turn Bay Length (m)	45.0		50.0	55.0		55.0				110.0		
Base Capacity (vph)	500	674	640	443	887	829	125	2224		282	1581	
Starvation Cap Reductn	0	0	0	0	0	0	0	0		0	0	
Spillback Cap Reductn	0	0	0	0	0	0	0	0		0	0	
Storage Cap Reductn	0	0	0	0	0	0	0	0		0	0	
Reduced v/c Ratio	0.09	0.12	0.50	0.52	0.04	0.12	0.38	0.30		0.13	0.72	

Intersection Summary

Area Type: Other
 Cycle Length: 95
 Actuated Cycle Length: 95
 Offset: 2 (2%), Referenced to phase 2:NBTL and 6:SBTL, Start of Green
 Natural Cycle: 90
 Control Type: Actuated-Coordinated
 Maximum v/c Ratio: 0.77
 Intersection Signal Delay: 23.2
 Intersection LOS: C
 Intersection Capacity Utilization 87.0%
 ICU Level of Service E
 Analysis Period (min) 15
 # 95th percentile volume exceeds capacity, queue may be longer.
 Queue shown is maximum after two cycles.

Splits and Phases: 4: Conroy & St. Laurent

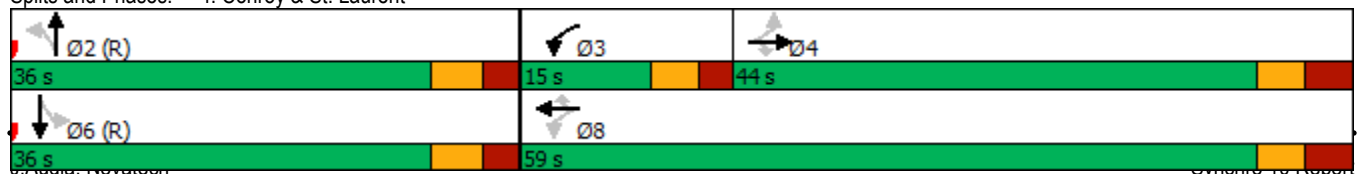



Lane Group	WBL	WBR	NBT	NBR	SBL	SBT
Lane Configurations						
Traffic Volume (vph)	23	96	107	76	172	51
Future Volume (vph)	23	96	107	76	172	51
Ideal Flow (vphpl)	1800	1800	1800	1800	1800	1800
Lane Util. Factor	1.00	1.00	1.00	1.00	1.00	1.00
Ped Bike Factor						
Frt	0.891		0.944			
Flt Protected	0.990					0.963
Satd. Flow (prot)	1462	0	1641	0	0	1592
Flt Permitted	0.990					0.963
Satd. Flow (perm)	1462	0	1641	0	0	1592
Link Speed (k/h)	50		50			50
Link Distance (m)	137.6		234.0			146.3
Travel Time (s)	9.9		16.8			10.5
Confl. Peds. (#/hr)				5	5	
Confl. Bikes (#/hr)		4		5		
Peak Hour Factor	1.00	1.00	1.00	1.00	1.00	1.00
Heavy Vehicles (%)	5%	8%	2%	3%	4%	20%
Adj. Flow (vph)	23	96	107	76	172	51
Shared Lane Traffic (%)						
Lane Group Flow (vph)	119	0	183	0	0	223
Enter Blocked Intersection	No	No	No	No	No	No
Lane Alignment	Left	Right	Left	Right	Left	Left
Median Width(m)	3.5		0.0			0.0
Link Offset(m)	0.0		0.0			0.0
Crosswalk Width(m)	2.0		10.0			10.0
Two way Left Turn Lane						
Headway Factor	1.09	1.09	1.09	1.09	1.09	1.09
Turning Speed (k/h)	24	14		14	24	
Sign Control	Stop		Free			Free

Intersection Summary

Area Type: Other

Control Type: Unsignalized

Intersection Capacity Utilization 41.9% ICU Level of Service A

Analysis Period (min) 15

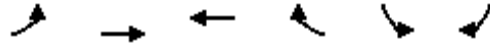

Lane Group	EBL	EBT	WBT	WBR	SBL	SBR
Lane Configurations						
Traffic Volume (vph)	1	249	122	11	9	1
Future Volume (vph)	1	249	122	11	9	1
Ideal Flow (vphpl)	1800	1800	1800	1800	1800	1800
Lane Util. Factor	1.00	1.00	1.00	1.00	1.00	1.00
Ped Bike Factor						
Frt			0.989		0.986	
Flt Protected					0.957	
Satd. Flow (prot)	0	1695	1682	0	1663	0
Flt Permitted					0.957	
Satd. Flow (perm)	0	1695	1682	0	1663	0
Link Speed (k/h)		50	50		50	
Link Distance (m)		40.4	197.7		90.8	
Travel Time (s)		2.9	14.2		6.5	
Confl. Peds. (#/hr)	10			10		
Confl. Bikes (#/hr)				3		3
Peak Hour Factor	1.00	1.00	1.00	1.00	1.00	1.00
Heavy Vehicles (%)	1%	5%	5%	1%	1%	1%
Adj. Flow (vph)	1	249	122	11	9	1
Shared Lane Traffic (%)						
Lane Group Flow (vph)	0	250	133	0	10	0
Enter Blocked Intersection	No	No	No	No	No	No
Lane Alignment	Left	Left	Left	Right	Left	Right
Median Width(m)		0.0	3.5		3.5	
Link Offset(m)		0.0	0.0		0.0	
Crosswalk Width(m)		0.0	0.0		5.0	
Two way Left Turn Lane						
Headway Factor	1.09	1.09	1.09	1.09	1.09	1.09
Turning Speed (k/h)	24			14	24	14
Sign Control		Free	Free		Stop	

Intersection Summary

Area Type: Other

Control Type: Unsignalized

Intersection Capacity Utilization 24.7% ICU Level of Service A

Analysis Period (min) 15

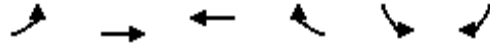

Lane Group	EBL	EBT	WBT	WBR	SBL	SBR
Lane Configurations						
Traffic Volume (vph)	1	247	119	4	3	0
Future Volume (vph)	1	247	119	4	3	0
Ideal Flow (vphpl)	1800	1800	1800	1800	1800	1800
Lane Util. Factor	1.00	1.00	1.00	1.00	1.00	1.00
Ped Bike Factor						
Frt	0.996					
Flt Protected	0.950					
Satd. Flow (prot)	0	1695	1691	0	1674	0
Flt Permitted	0.950					
Satd. Flow (perm)	0	1695	1691	0	1674	0
Link Speed (k/h)	50					
Link Distance (m)	137.6		40.4		92.1	
Travel Time (s)	9.9		2.9		6.6	
Confl. Peds. (#/hr)	10					10
Confl. Bikes (#/hr)					3	3
Peak Hour Factor	1.00	1.00	1.00	1.00	1.00	1.00
Heavy Vehicles (%)	1%	5%	5%	1%	1%	1%
Adj. Flow (vph)	1	247	119	4	3	0
Shared Lane Traffic (%)						
Lane Group Flow (vph)	0	248	123	0	3	0
Enter Blocked Intersection	No	No	No	No	No	No
Lane Alignment	Left	Left	Left	Right	Left	Right
Median Width(m)	0.0		0.0		3.5	
Link Offset(m)	0.0		0.0		0.0	
Crosswalk Width(m)	0.0		0.0		5.0	
Two way Left Turn Lane						
Headway Factor	1.09	1.09	1.09	1.09	1.09	1.09
Turning Speed (k/h)	24			14		
Sign Control	Free		Free		Stop	









Intersection Summary

Area Type: Other

Control Type: Unsignalized







Intersection Capacity Utilization 24.6% ICU Level of Service A

Analysis Period (min) 15

						
Lane Group	WBL	WBR	NBT	NBR	SBL	SBT
Lane Configurations						
Traffic Volume (vph)	1	10	238	1	13	223
Future Volume (vph)	1	10	238	1	13	223
Ideal Flow (vphpl)	1800	1800	1800	1800	1800	1800
Lane Util. Factor	1.00	1.00	1.00	1.00	1.00	1.00
Ped Bike Factor						
Frt	0.877		0.999			
Flt Protected	0.995					0.997
Satd. Flow (prot)	1538	0	1694	0	0	1694
Flt Permitted	0.995					0.997
Satd. Flow (perm)	1538	0	1694	0	0	1694
Link Speed (k/h)	50		50			50
Link Distance (m)	105.3		30.4			100.3
Travel Time (s)	7.6		2.2			7.2
Confl. Peds. (#/hr)				10	10	
Confl. Bikes (#/hr)		3		3		
Peak Hour Factor	1.00	1.00	1.00	1.00	1.00	1.00
Heavy Vehicles (%)	1%	1%	5%	1%	1%	5%
Adj. Flow (vph)	1	10	238	1	13	223
Shared Lane Traffic (%)						
Lane Group Flow (vph)	11	0	239	0	0	236
Enter Blocked Intersection	No	No	No	No	No	No
Lane Alignment	Left	Right	Left	Right	Left	Left
Median Width(m)	3.5		3.5			3.5
Link Offset(m)	0.0		0.0			0.0
Crosswalk Width(m)	5.0		0.0			0.0
Two way Left Turn Lane						
Headway Factor	1.09	1.09	1.09	1.09	1.09	1.09
Turning Speed (k/h)	24	14		14	24	
Sign Control	Stop		Free			Free
Intersection Summary						
Area Type:	Other					
Control Type:	Unsignalized					
Intersection Capacity Utilization	33.6%			ICU Level of Service A		
Analysis Period (min)	15					

3: Conroy & Walkley
PM Peak Hour

2510 St. Laurent Boulevard
2029 Total Traffic (mitigated timing)

							
Lane Group	EBT	EBR	WBL	WBT	NBU	NBL	NBR
Lane Configurations	↑↑	↑	↑↑	↑↑		↑↑	↑
Traffic Volume (vph)	1319	474	545	1180	45	484	334
Future Volume (vph)	1319	474	545	1180	45	484	334
Ideal Flow (vphpl)	1800	1800	1800	1800	1800	1800	1800
Storage Length (m)		75.0	200.0			0.0	0.0
Storage Lanes		1	2			2	1
Taper Length (m)			50.0			10.0	
Lane Util. Factor	0.95	1.00	0.97	0.95	0.95	0.97	1.00
Ped Bike Factor		0.95	0.99				0.95
Frt		0.850					0.850
Flt Protected			0.950			0.950	
Satd. Flow (prot)	3221	1483	3185	3349	0	3248	1469
Flt Permitted			0.950			0.950	
Satd. Flow (perm)	3221	1410	3154	3349	0	3248	1402
Right Turn on Red		Yes					Yes
Satd. Flow (RTOR)		427					334
Link Speed (k/h)	50			50		60	
Link Distance (m)	169.1			271.7		348.5	
Travel Time (s)	12.2			19.6		20.9	
Confl. Peds. (#/hr)		30	30				20
Confl. Bikes (#/hr)		4					4
Peak Hour Factor	1.00	1.00	1.00	1.00	1.00	1.00	1.00
Heavy Vehicles (%)	5%	2%	3%	1%	1%	1%	3%
Adj. Flow (vph)	1319	474	545	1180	45	484	334
Shared Lane Traffic (%)							
Lane Group Flow (vph)	1319	474	545	1180	0	529	334
Enter Blocked Intersection	No	No	No	No	No	No	No
Lane Alignment	Left	R NA	Left	Left	R NA	L NA	R NA
Median Width(m)	7.0			9.0		10.5	
Link Offset(m)	0.0			0.0		0.0	
Crosswalk Width(m)	5.0			5.0		5.0	
Two way Left Turn Lane							
Headway Factor	1.09	1.09	1.09	1.09	1.09	1.09	1.09
Turning Speed (k/h)		14	24		14	24	14
Number of Detectors	2	1	1	2	1	1	1
Detector Template	Thru	Right	Left	Thru	Left	Left	Right
Leading Detector (m)	30.5	6.1	6.1	30.5	6.1	6.1	6.1
Trailing Detector (m)	0.0	0.0	0.0	0.0	0.0	0.0	0.0
Detector 1 Position(m)	0.0	0.0	0.0	0.0	0.0	0.0	0.0
Detector 1 Size(m)	1.8	6.1	6.1	1.8	6.1	6.1	6.1
Detector 1 Type	Cl+Ex	Cl+Ex	Cl+Ex	Cl+Ex	Cl+Ex	Cl+Ex	Cl+Ex
Detector 1 Channel							
Detector 1 Extend (s)	0.0	0.0	0.0	0.0	0.0	0.0	0.0
Detector 1 Queue (s)	0.0	0.0	0.0	0.0	0.0	0.0	0.0
Detector 1 Delay (s)	0.0	0.0	0.0	0.0	0.0	0.0	0.0
Detector 2 Position(m)	28.7			28.7			
Detector 2 Size(m)	1.8			1.8			
Detector 2 Type	Cl+Ex			Cl+Ex			
Detector 2 Channel							
Detector 2 Extend (s)	0.0			0.0			
Turn Type	NA	Perm	Prot	NA	Perm	Prot	Perm
Protected Phases	2		1	6		8	
Permitted Phases		2			8		8
Detector Phase	2	2	1	6	8	8	8



Lane Group	EBT	EBR	WBL	WBT	NBU	NBL	NBR
Switch Phase							
Minimum Initial (s)	10.0	10.0	5.0	10.0	5.0	5.0	5.0
Minimum Split (s)	36.4	36.4	16.0	24.7	30.4	30.4	30.4
Total Split (s)	59.0	59.0	30.0	89.0	31.0	31.0	31.0
Total Split (%)	49.2%	49.2%	25.0%	74.2%	25.8%	25.8%	25.8%
Maximum Green (s)	52.6	52.6	23.8	82.6	24.6	24.6	24.6
Yellow Time (s)	3.7	3.7	3.3	3.7	3.7	3.7	3.7
All-Red Time (s)	2.7	2.7	2.9	2.7	2.7	2.7	2.7
Lost Time Adjust (s)	0.0	0.0	0.0	0.0		0.0	0.0
Total Lost Time (s)	6.4	6.4	6.2	6.4		6.4	6.4
Lead/Lag	Lag	Lag	Lead				
Lead-Lag Optimize?	Yes	Yes	Yes				
Vehicle Extension (s)	3.0	3.0	3.0	3.0	3.0	3.0	3.0
Recall Mode	C-Max	C-Max	None	C-Max	None	None	None
Walk Time (s)	10.0	10.0			7.0	7.0	7.0
Flash Dont Walk (s)	20.0	20.0			17.0	17.0	17.0
Pedestrian Calls (#/hr)	20	20			15	15	15
Act Effct Green (s)	54.7	54.7	23.1	84.0		23.2	23.2
Actuated g/C Ratio	0.46	0.46	0.19	0.70		0.19	0.19
v/c Ratio	0.90	0.54	0.89	0.50		0.84	0.62
Control Delay	40.3	5.8	64.9	9.5		59.6	9.8
Queue Delay	6.3	0.0	0.0	0.0		0.0	0.0
Total Delay	46.7	5.8	64.9	9.5		59.6	9.8
LOS	D	A	E	A		E	A
Approach Delay	35.9			27.0		40.3	
Approach LOS	D			C		D	
Queue Length 50th (m)	140.4	5.8	59.4	58.6		56.5	0.0
Queue Length 95th (m)	#184.1	28.0	#84.7	72.0		74.5	23.7
Internal Link Dist (m)	145.1			247.7		324.5	
Turn Bay Length (m)		75.0	200.0				
Base Capacity (vph)	1467	874	631	2343		665	552
Starvation Cap Reductn	120	11	0	0		0	0
Spillback Cap Reductn	0	0	0	0		0	0
Storage Cap Reductn	0	0	0	0		0	0
Reduced v/c Ratio	0.98	0.55	0.86	0.50		0.80	0.61

Intersection Summary

Area Type: Other
 Cycle Length: 120
 Actuated Cycle Length: 120
 Offset: 20 (17%), Referenced to phase 2:EBT and 6:WBT, Start of Green
 Natural Cycle: 95
 Control Type: Actuated-Coordinated
 Maximum v/c Ratio: 0.90
 Intersection Signal Delay: 33.2 Intersection LOS: C
 Intersection Capacity Utilization 88.6% ICU Level of Service E
 Analysis Period (min) 15
 # 95th percentile volume exceeds capacity, queue may be longer.
 Queue shown is maximum after two cycles.

Splits and Phases: 3: Conroy & Walkley

