

951 Gladstone Avenue and 145 Loretta Avenue North Transportation Impact Assessment

Step 1 Screening Report

Step 2 Scoping Report

Step 3 Forecasting Report

Step 4 Strategy Report (Revision #6)

Prepared for:

TIP Gladstone Limited Partnership
200-485 Bank Street
Ottawa, ON K2P 1Z2

Prepared by:



6 Plaza Court
Ottawa, ON K2H 7W1

September 2024

PN: 2020-25

Table of Contents

1	Screening.....	1
2	Existing and Planned Conditions.....	1
2.1	Proposed Development.....	1
2.2	Existing Conditions.....	3
2.2.1	Area Road Network.....	3
2.2.2	Existing Intersections.....	3
2.2.3	Existing Driveways.....	4
2.2.4	Cycling and Pedestrian Facilities.....	4
2.2.5	Existing Transit.....	6
2.2.6	Existing Area Traffic Management Measures.....	8
2.2.7	Existing Peak Hour Travel Demand.....	8
2.2.8	Collision Analysis.....	9
2.3	Planned Conditions.....	13
2.3.1	Changes to the Area Transportation Network.....	13
2.3.2	Other Study Area Developments.....	13
3	Study Area and Time Periods.....	14
3.1	Study Area.....	14
3.2	Time Periods.....	14
3.3	Horizon Years.....	14
4	Exemption Review.....	15
5	Development-Generated Travel Demand.....	15
5.1	Mode Shares.....	15
5.2	Trip Generation.....	16
5.3	Trip Distribution.....	17
5.4	Trip Assignment.....	18
6	Background Network Travel Demands.....	18
6.1	Transportation Network Plans.....	18
6.2	Background Growth.....	19
6.3	Other Developments.....	19
7	Demand Rationalization.....	19
7.1	Modal Share Sensitivity.....	19
8	Development Design.....	19
8.1	Design for Sustainable Modes.....	19
8.2	Circulation and Access.....	19
9	Parking.....	20
9.1	Parking Supply.....	20
10	Boundary Street Design.....	20
11	Access Intersections Design.....	21
11.1	Location and Design of Access.....	21
11.2	Intersection Control.....	21
11.3	Access Intersection Design.....	21
11.3.1	Future Total Access Intersection Operations.....	21

11.3.2	Access Intersection MMLOS	23
11.3.3	Recommended Design Elements.....	23
12	Transportation Demand Management	23
12.1	Context for TDM	23
12.2	Need and Opportunity.....	23
12.3	TDM Program	23
13	Neighbourhood Traffic Management.....	23
14	Transit.....	24
14.1	Route Capacity.....	24
14.2	Transit Priority	24
15	Network Intersection Design.....	24
15.1	Network Intersection Control.....	24
15.2	Network Intersection Design.....	25
15.2.1	Future Total Network Intersection Operations.....	25
15.2.2	Network Intersection MMLOS.....	26
15.2.3	Recommended Design Elements.....	26
16	Summary of Improvements Indicated and Modifications Options.....	26
17	Conclusion	30

List of Figures

Figure 1: Area Context Plan	1
Figure 2: Concept Plan.....	2
Figure 3: Study Area Pedestrian Facilities	4
Figure 4: Study Area Cycling Facilities	5
Figure 5: Existing Pedestrian Volumes	5
Figure 6: Existing Cycling Volumes	6
Figure 7: Existing Study Area Transit Service.....	7
Figure 8: Existing Study Area Transit Stops	7
Figure 9: Existing Traffic Counts	8
Figure 10: Study Area Collision Records – Representation of 2016-2020.....	10
Figure 11: Gladstone Station District CDP Vision & Concept Options Report – Preferred Option: Perspective Looking North-East	13
Figure 12: New Site Generation Auto Volumes.....	18
Figure 13: Future Total Volumes	22

Table of Tables

Table 1: Intersection Count Date.....	8
Table 2: Existing Intersection Operations.....	9
Table 3: Study Area Collision Summary, 2016-2020	10
Table 4: Summary of Collision Locations, 2016-2020.....	11
Table 5: Gladstone Avenue and Bayswater Avenue Collision Summary.....	11
Table 6: Gladstone Avenue and Preston Street Collision Summary.....	11

Table 7: Somerset Street W between Breezehill Avenue and Preston Street Collision Summary	12
Table 8: Exemption Review	15
Table 9: TRANS Trip Generation Manual Recommended Mode Shares – Ottawa West	15
Table 10: Proposed Development Mode Shares	16
Table 11: Trip Generation Person Trip Rates	16
Table 12: Total Development Person Trip Generation	16
Table 13: Internal Capture Rates	16
Table 14: Trip Generation by Mode	17
Table 15: OD Survey Distribution	17
Table 16: Boundary Street MMLOS Analysis	20
Table 17: Future Total Access Intersection Operations	22
Table 18: Trip Generation by Transit Mode	24
Table 19: Forecasted Site-Generated Transit Ridership	24
Table 20: Future Total Network Intersection Operations	25
Table 21: Study Area Intersection MMLOS Analysis	26

List of Appendices

- Appendix A – TIA Screening Form and Certification Form
- Appendix B – Turning Movement Count Data
- Appendix C – Synchro Intersection Worksheets – Existing Conditions
- Appendix D – Collision Data
- Appendix E – TDM Checklist
- Appendix F – Turning Templates
- Appendix G – MMLOS Analysis
- Appendix H – Synchro Intersection Worksheets – Future Total Conditions
- Appendix I – Signal Warrant – OTM Justification 7

1 Screening

This study has been prepared according to the City of Ottawa’s 2017 Transportation Impact Assessment (TIA) Guidelines, prior to the June 2023 updates. A TIA report was submitted and approved for the zoning bylaw amendment in 2019. This report provides an update on the existing conditions, forecasting and network impact component and the submission of the design review component. Accordingly, the Step 1 Screening Form has been revised and is included as Appendix A, along with the Certification Form for TIA Study PM. This TIA will support the site plan application.

2 Existing and Planned Conditions

2.1 Proposed Development

The proposed development is located at 951 Gladstone Avenue and 145 Loretta Avenue North and has undergone an Official Plan and Zoning amendment to rezone the site from general industry (IG) zoning to mixed-use centre (MC). The existing land uses have been closed and previously included a brewery, jujitsu club, cross-fit gym, glass blowing, art studio, beer and wine supply, bread bakery, and other assorted industrial uses. The proposed site plan application consists of approximately 872 residential units, 198,524 sq. ft of office space (including the existing Standard Bread building, live-work space) and 17,611 sq. ft of retail space. A total of 526 parking spaces will be provided (including visitor spaces), with four at ground level and the remaining 522 in the three levels of underground parking. A total of 762 bicycle parking spaces are proposed, including 68 surface parking and 694 underground parking spaces. Four existing accesses and street edge parking will be removed and replaced with a new two-way general access between Towers 1 and 2, with a one-way loop extending past Tower 2 to Loretta Avenue North and a two-way access for Tower 3. A loading/move-in areas will be provided adjacent to the underground parking ramps. The frontage along Loretta Avenue North would formalize the curb edge and remove the paved shoulder and open access along the building frontage. The anticipated full build-out and occupancy horizon is 2026. Figure 1 illustrates the Study Area Context. Figure 2 illustrates the proposed concept plan.

Figure 1: Area Context Plan

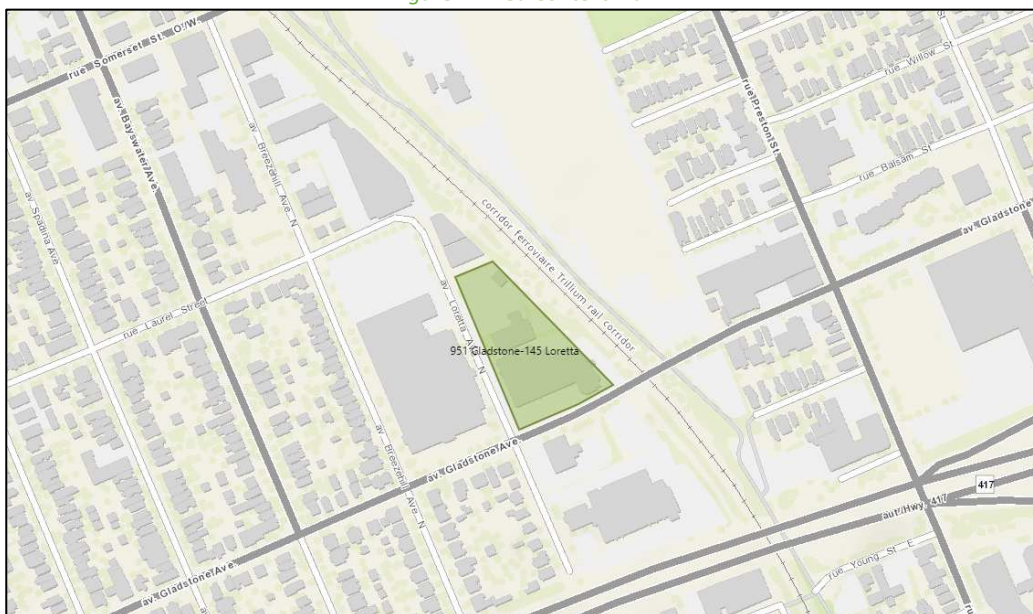

Source: <http://maps.ottawa.ca/geoOttawa/> Accessed: March 21, 2021

Figure 2: Concept Plan

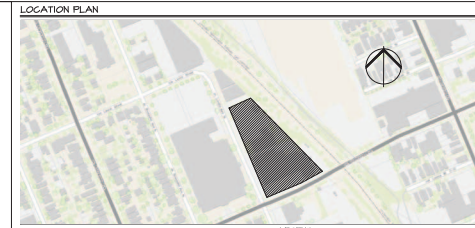
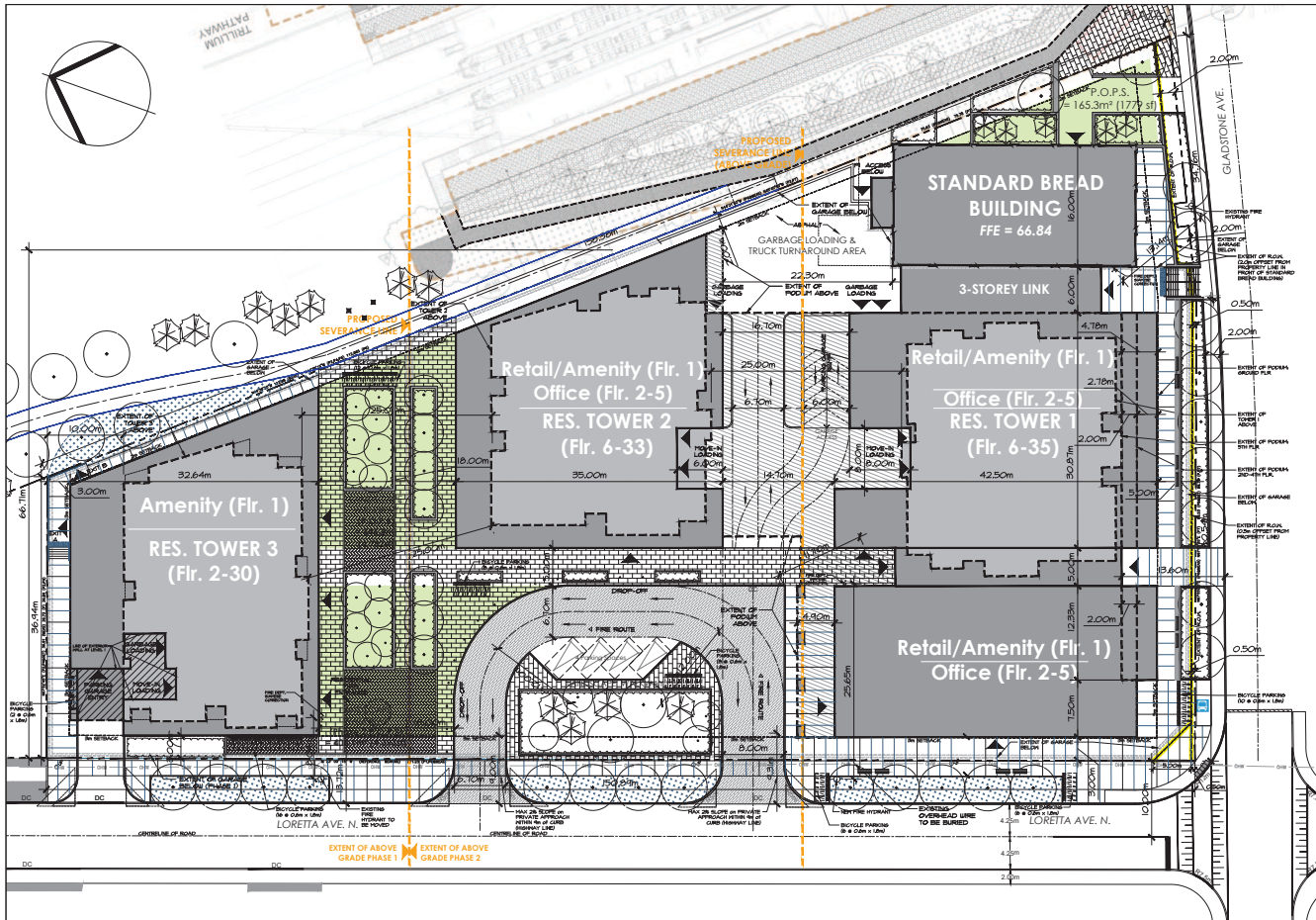

LEGEND

BUS STOP	
EXISTING OVERHEAD WIRES (TO BE BURIED)	
FIRE HYDRANT EXISTING 4 NEW - as noted	
EXISTING UTILITY POLE (TO BE REMOVED)	
PROPERTY LINE	
SETBACK LINE	
FIRE ROUTE	
PRIVATELY OWNED PUBLIC SPACE (POPS)	
EXTENT OF GARAGE BELOW	
ROAD WIDENING LINE	

SURVEY INFORMATION TAKEN FROM:

STANTEC GEOMATICS LTD. 2017

SITE STATISTICS

SITE AREA	10,012m ² / 2.41 ac
RESIDENTIAL UNIT COUNT:	
TOWER 1	= 274
TOWER 2	= 251
TOWER 3	= 232
TOTAL	= 872

Gladstone and Loretta Mixed-Use Hub Draft Zoning Table

MC[XXXX] SYYY-A	Requirement	Proposed
Minimum Lot Width (m)	No minimum	Complies
Minimum Lot Area (m ²)	No minimum	Complies
Minimum Front Yard Setback (m)	5 metres, aside from Standard Bread Building (See S.YYY)	5m
Minimum Rear Yard Setback (m)	3 metres (See S.YYYY)	3m
Interior Side Yard Setback (m)	2 metres, aside from Standard Bread Building (See S.YYYY)	2m
Corner Side Yard Setback (m)	3 metres (See S.YYYY)	3m
Minimum Building Height (m)	6.7m (See S.YYY)	Complies
Maximum Building Height (m)	0m to 132m (See S.YYYY)	Complies
Maximum Floor Space Index	No maximum	N/A
Minimum Width of Landscaped Area	No minimum, except that where a yard is provided and not used for required driveways, aisles, parking, loading spaces or outdoor commercial patio, the whole yard must be landscaped	Complies
Minimum Tower Separation Distance	23 metres	Complies
Minimum Tower Podium Stepback Distance	2 metres	2m at Gladstone frontage only

Parking Requirements (Sec. 101, 102, 106, 111)	Requirement	Proposed
Area Z of Schedule 1A	Resident: 0 Visitor: 30	Surface: 4 P1: 218 P2: 251 P3: 53 Total: 526
Vehicle Space Dimensions	- Must be 2.6m-3.1m by 5.2m - Lip to 40% of required parking aside from visitor's spaces may be 2.4m x 4.6m	Complies
Bicycle Parking Rates	(0.5 per Dwelling Unit) = 436 (1 per 250m ² Commercial space) 20,000m ² /250 = 80.3 Total Required = 516	Surface Bicycle Parking = 68 Indoor Bicycle Parking (P1) = 69.4 Total Bicycle Parking = 137.4
Bicycle Space Dimensions	Horizontal: 0.6m x 1.6m Vertical: 0.5m x 1.5m (max 50% of required spaces) Stacked: 0.37m x 1.5m	Complies

Drive Aisle Width (Double Traffic Lane) (Sec. 137)	Parking Lot	Requirement	Proposed
	Parking	Minimum: 6.7m	6m
	Garage	Minimum: 6m Maximum: 6.7m	6m
Amenity Space Requirements (Sec. 137)	Requirement	Proposed	
Total: 6m ² per unit	Total: 5,232 m ² Communal: 2,616 m ²	Rooftop Terrace (Communal): 1,441.9m ² Indoor Amenity (Communal): 2,022.7 m ² Balconies: ~3,548.2m ²	
POPS (Privately Owned Public Space)		POPS: 1,017.7 m ²	

PROJECT CONSULTANTS:

Owner / Applicant	CIVIL
CLV GROUP 485 Bank Street, Suite 200 Ottawa, ON K2P 1Z2	WSP 150 Slater Street Ottawa, ON K1P 5M8
PPG GROUP 205-485 Bank Street Ottawa, ON K2P 1Z2	Contact: Michael Flowers phone: (613) 586-0205 email: michael.flowers@wsp.com
Jean Morisse phone: (613) 691-0260 email: jean.morisse@clvgroup.com	Surveyor
Architect	Stantec Geomatics Ltd. 400-1331 Clyde Ave. Ottawa, ON K2C 3C4
Hobin Architecture Inc. 63 Pamela Street Ottawa, ON K1S 3K7	Contact: Brian Webster phone: (613) 722-4420 email: brian.webster@stantec.com
Contact: Todd Blackworth phone: (613) 238-7200 x 130 email: todd.blackworth@hobinarc.com web: www.hobinarc.com	Geotechnical
Planning	Patterson Group Inc. 154 Colonnade Road South Ottawa, ON K2E 7J5
Foteren Planning & Design 360 Cooper Street, Suite 300 Ottawa, ON K2P 2H7	Contact: Celia Da Silva phone: (613) 226-7361 email: celia@foterenongroup.ca
Contact: Paul Bank phone: (613) 750-5700 x 239 email: paul.bank@foteren.com	Transportation
Landscape	CGH Transportation Inc. 13 Markham Ave. Ottawa, ON K2C 3Z1
CSW Landscape Architects Limited 319 McEwen Ave. Ottawa, ON K1Z 0B9	Contact: Chris Gordon phone: (343) 999-9117 email: christopher.gordon@cgtransportation.com
Contact: JERRY Conah phone: (613) 724-4636 email: conah@csa.ca	Heritage
	Commonwealth Historic Resource Management 53 Herriott Street Perth, ON, K7H 1T5
	Contact: John Stewart phone: (613) 202-7040 email: jst@chrm.com

PROJECT LOCATION:
951 GLADSTONE AVE. & 145 LORETTA AVE. NORTH

DRAWING TITLE:
SITE PLAN

DRAWN BY: TR	DATE: MAY 2024	SCALE: 1:50
PROJECT: 105	DRAWING NO.: S1	REVISION NO.: 18526



PBCGROUP

CLV GROUP

10 JAN 25 2024	SITE PLAN COMMENTS
09 APR 17 2024	SITE PLAN COMMENTS
08 DEC 16 2023	COORDINATION
07 AUG 16 2023	SITE PLAN COMMENTS
06 NOV 04 2022	REVISED PHASE LINE
05 OCT 10 2022	SITE PLAN COMMENTS
04 MAR 02 2022	SITE PLAN COMMENTS
03 APR 04 2021	SITE PLAN

no. date revision

It is the responsibility of the appropriate contractor to check and verify all dimensions on site and report all errors and/or omissions to the architect.

All contractors must comply with all permit codes and by-laws.

Do not scale drawings.

This drawing may not be used for construction unless signed.

Copyright reserved.

CANTARIO ASSOCIATION
LICENCE 3049

HOBIN ARCHITECTURE

PROJECT LOCATION:
951 GLADSTONE AVE. & 145 LORETTA AVE. NORTH

DRAWING TITLE:
SITE PLAN

DRAWN BY: TR	DATE: MAY 2024	SCALE: 1:50
PROJECT: 105	DRAWING NO.: S1	REVISION NO.: 18526

2.2 Existing Conditions

2.2.1 Area Road Network

Preston Street: Preston Street is a City of Ottawa arterial road with a two-lane urban cross-section, including parking lanes and auxiliary lanes at major intersections. The unposted speed limit is 50 km/h, and the Ottawa Official Plan reserves a 23.0 metre right-of-way.

Somerset Street West: Somerset Street West is a City of Ottawa arterial road with a two-lane cross-section, including sidewalks and on street parking. The unposted speed limit is 50 km/h, and the right-of-way is 20.0 metres. East of Breezehill Avenue, bike lanes are provided.

Gladstone Avenue: Gladstone Avenue is a City of Ottawa major collector road with a two-lane urban cross-section including sidewalks and a posted speed limit of 40 km/h. The current right-of-way is 20.0 metres, with additional width provided in proximity to the rail corridor.

Bayswater Avenue: Bayswater Avenue is a City of Ottawa collector road with a two-lane urban cross-section, including sidewalks and on-street parking. The posted speed limit is 30 km/h, and the right-of-way is 25.0 metres.

Loretta Avenue North/Laurel Street: Loretta Avenue N is a City of Ottawa local road with a two-lane urban cross-section including paved shoulders on the east side and a sidewalk on the west side. The posted speed is 40 km/h, and the right-of-way is 20.0 metres.

Breezehill Avenue: Breezehill Avenue is a City of Ottawa local road with a two-lane urban cross-section, including sidewalks, and parking on the east side of the road. The posted speed limit is 40 km/h, and the right-of-way is 20.0 metres.

2.2.2 Existing Intersections

The existing signalized area intersections within one kilometre of the site have been summarized below:

<i>Gladstone Avenue & Bayswater Avenue</i>	The intersection of Gladstone Avenue and Bayswater Avenue is a signalized intersection with shared all movement lanes on each approach. No turn restrictions were noted.
<i>Gladstone Avenue & Preston Street</i>	The intersection of Gladstone Avenue and Preston Street is a signalized intersection with auxiliary left-turn lanes on the northbound, westbound, and southbound approaches. Eastbound and southbound right turns on red are prohibited.
<i>Somerset Street West & Breezehill Avenue</i>	The intersection of Somerset Street West and Breezehill Avenue is a minor stop-controlled intersection with shared movement lanes on all approaches. Bike lanes along Somerset Street West start/end on the east side of the intersection. No turn restrictions were noted.
<i>Gladstone Avenue & Loretta Avenue North</i>	The intersection of Gladstone Avenue and Loretta Avenue N is a minor stop-controlled intersection with shared movement lanes on all approaches. No turn restrictions were noted.

Laurel Street & Breezehill Avenue

The intersection of Laurel Street and Breezehill Avenue is an all-way stop-controlled intersection with shared movement lanes on all approaches. No turn restrictions were noted.

2.2.3 Existing Driveways

Along Gladstone Avenue, a driveway to the City of Ottawa yard (175 Loretta Avenue North) is located opposite the existing Standard Bread access adjacent to the Trillium Rail Corridor, and an access to 950 Gladstone Avenue within 5.0 metres of the Loretta Avenue North intersection. Between Loretta Avenue North and Breezehill Avenue, an access loop is located on the north side of Gladstone Avenue to the Canadian Bank Note Limited, and five driveways are located on the south side.

Along Loretta Avenue North, two accesses are provided on the west side of the road for the Canadian Bank Note Limited site, and a single access is located north of the proposed site for 131 Loretta Avenue North. The paved shoulder is used for perpendicular parking along Loretta Avenue North as well.

2.2.4 Cycling and Pedestrian Facilities

Figure 3 illustrates the pedestrian facilities in the study area and Figure 4 illustrates the cycling facilities. Figure 5 and Figure 6 illustrate the existing pedestrian and cycling volumes within the study area.

Sidewalks are provided along both sides of the roadways in the study area with the exception of the east side of Breezehill Avenue between Gladstone Avenue and Laurel Street, on both sides of Laurel Street, and the east side of Loretta Avenue North. The Trillium Pathway is a multi-use pathway along the east side of the Trillium Rail Corridor.

The Ottawa Cycling Plan (2013) consists of the Trillium Pathway as a cross-town bikeway, suggested biking routes along Gladstone Avenue, Bayswater Avenue and Somerset Street W, including bike lanes on the bridge over the Trillium Rail Corridor.

Figure 3: Study Area Pedestrian Facilities

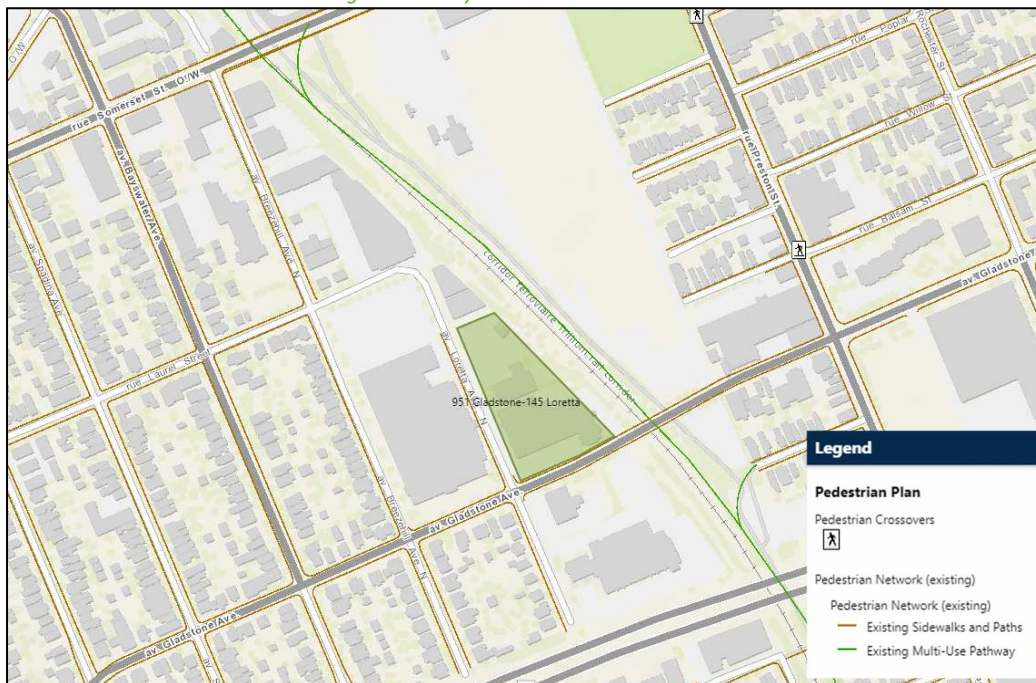

Source: <http://maps.ottawa.ca/geoOttawa/> Accessed: March 31, 2021

Figure 4: Study Area Cycling Facilities

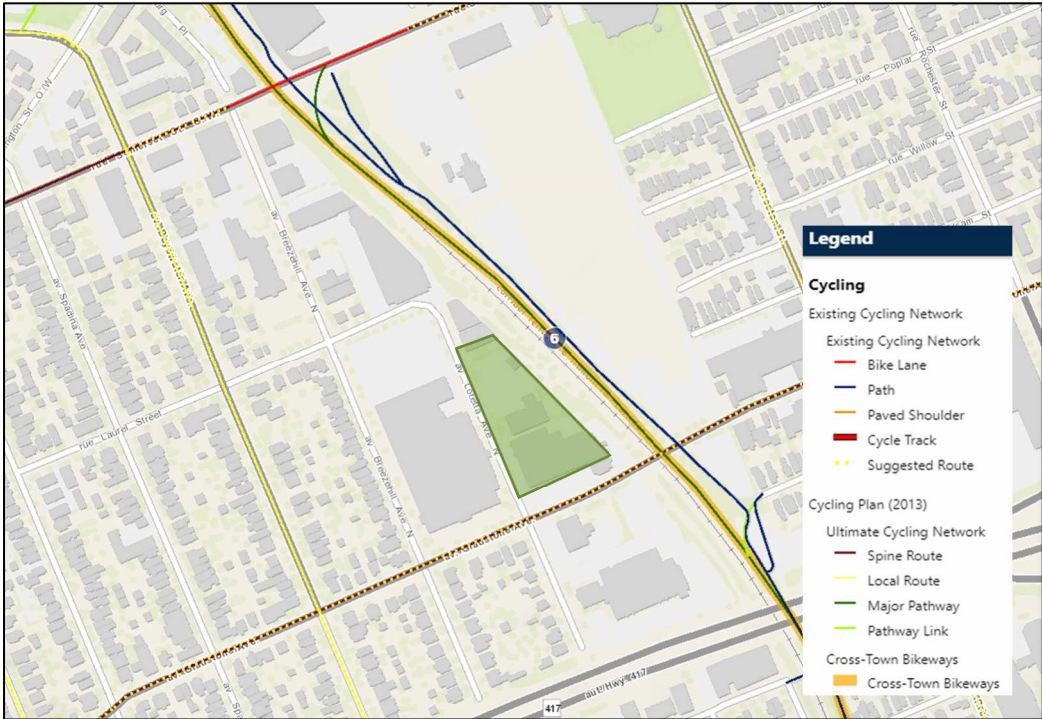

Source: <http://maps.ottawa.ca/geoOttawa/> Accessed: September 27, 2022

Figure 5: Existing Pedestrian Volumes

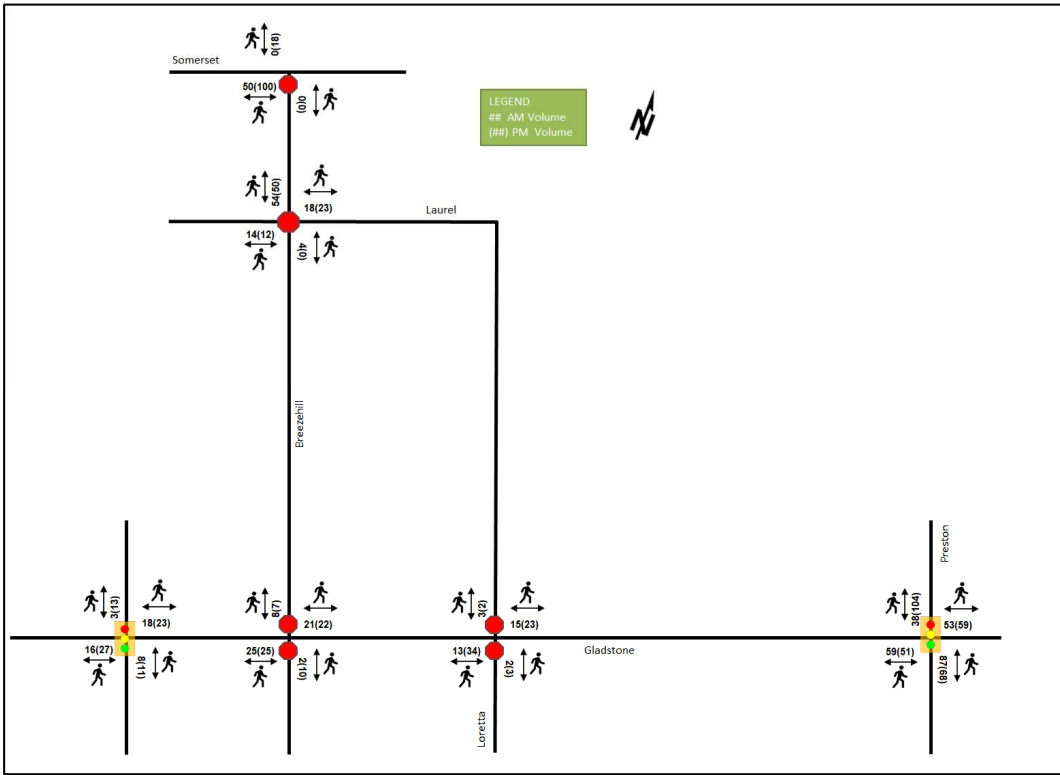
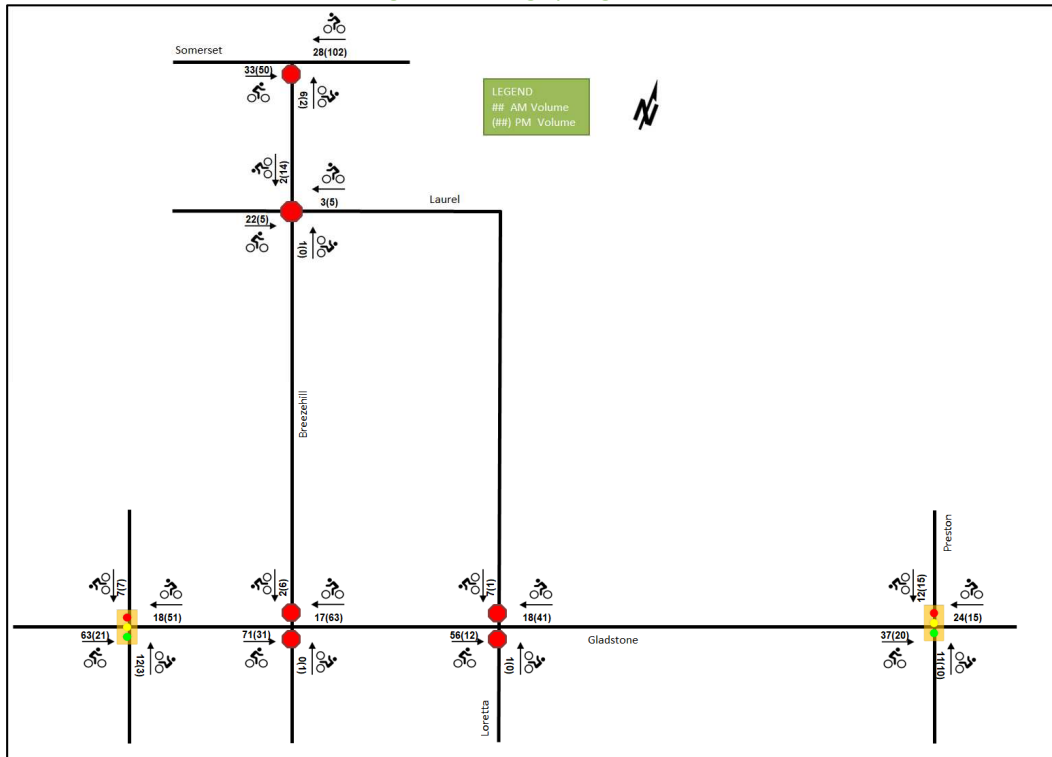

Figure 6: Existing Cycling Volumes



2.2.5 Existing Transit

Figure 7 illustrates the transit system map in the study area and Figure 8 illustrates nearby transit stops. All transit information is from September 27, 2022, and is included for general information purposes and context to the surrounding area.

Within the study area, the routes #11, #14 and #114 run along Gladstone Avenue, Somerset Street and Preston Street. The frequency of these routes within proximity of the proposed site based on September 27, 2022, service levels are:

- Route #11 – every 10-15 minutes during the day and 20-30 minutes during the evening
- Route # 14 – every 15-20 minutes during the day and 20-30 minutes during the evening
- Route #85 – every 10-20 minutes during the day and 20-30 minutes during the evening
- Route # 114 – two trips during the AM peak to Rideau and two trips during the PM peak to Caldwell/Merivale

Figure 7: Existing Study Area Transit Service

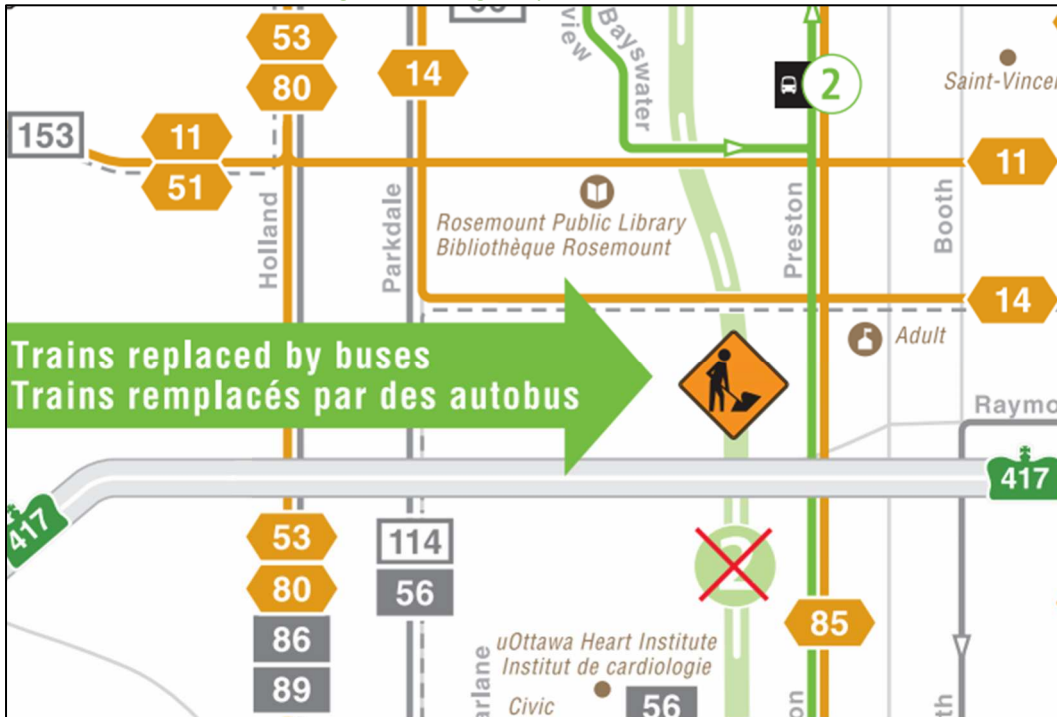

Source: <http://www.octranspo.com/> Accessed: September 27, 2022

Figure 8: Existing Study Area Transit Stops

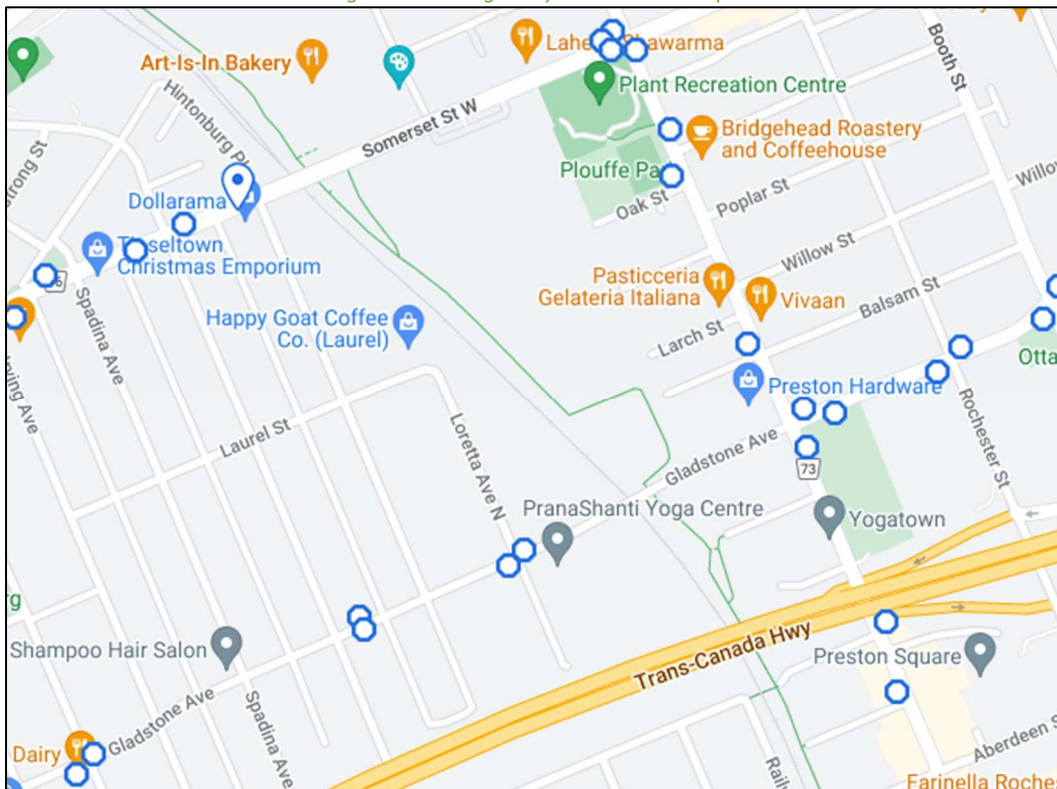

Source: <http://www.octranspo.com/> Accessed: September 27, 2022

2.2.6 Existing Area Traffic Management Measures

There are no existing area traffic management measures within the Study Area.

2.2.7 Existing Peak Hour Travel Demand

Existing turning movement counts were acquired from the City of Ottawa and new traffic count surveys for the existing Study Area intersection. Table 1 summarizes the intersection count dates and sources.

Table 1: Intersection Count Date

Intersection	Count Date	Source
Gladstone Avenue and Bayswater Avenue	Wednesday July 27, 2016	City of Ottawa
Gladstone Avenue and Breezehill Avenue	Wednesday, July 18, 2018	City of Ottawa
Gladstone Avenue and Loretta Avenue	Tuesday, April 23, 2019	The Traffic Specialist
Gladstone Avenue and Preston Street	Tuesday June 20,2017	City of Ottawa
Laurel Street and Breezehill Avenue	Tuesday, April 23, 2019	The Traffic Specialist
Somerset Street West and Breezehill Avenue	Thursday August 12, 2015	City of Ottawa

Figure 9 illustrates the existing traffic counts and Table 2 summarizes the existing intersection operations. The level of service for signalized intersections is based on volume to capacity ratio (v/c) calculations for individual lane movements and HCM 2000 v/c calculations for the overall intersection, and average delay for unsignalized intersections. The volumes have been balanced through the network. Detailed turning movement count data is included in Appendix B and the Synchro worksheets are provided in Appendix C.

Figure 9: Existing Traffic Counts

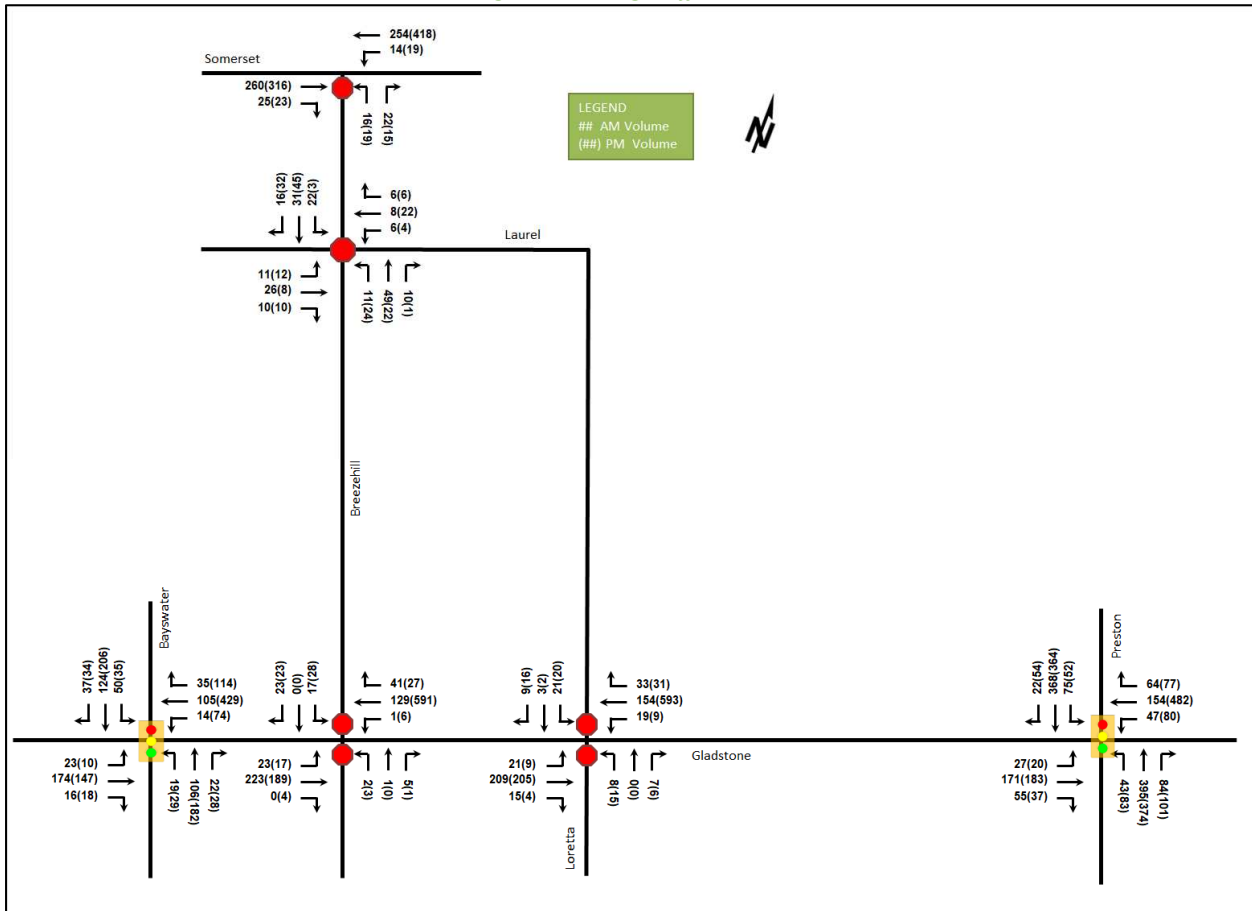

Table 2: Existing Intersection Operations

Intersection	Lane	AM Peak Hour				PM Peak Hour			
		LOS	V/C	Delay	Q (95th)	LOS	V/C	Delay	Q (95th)
Gladstone Avenue & Preston Street <i>Signalized</i>	EB	C	0.76	37.8	#57.3	A	0.50	20.0	47.8
	WBL	A	0.27	23.8	13.6	A	0.23	16.0	17.5
	WBT/R	A	0.59	25.9	43.1	E	0.91	40.2	#140.8
	NBL	A	0.11	8.5	7.6	A	0.39	19.7	19.0
	NBT/R	A	0.55	12.2	68.1	C	0.76	24.4	85.2
	SBL	A	0.23	10.3	12.8	A	0.29	17.7	12.7
	SBT/R	A	0.43	10.7	52.0	B	0.67	21.8	73.0
Overall	B	0.61	18.3	-	-	D	0.83	27.2	-
Gladstone Avenue & Loretta Avenue North <i>Unsignalized</i>	EB	A	0.02	7.8	0.8	A	0.01	9.2	0.0
	WB	A	0.02	7.8	0.8	A	0.01	7.9	0.0
	NB	B	0.03	11.9	0.8	C	0.09	20.3	2.3
	SB	B	0.08	12.9	1.5	C	0.15	20.3	3.8
	Overall	A	-	1.8	-	-	A	-	1.5
Gladstone Avenue & Breezehill Avenue <i>Unsignalized</i>	EB	A	0.02	7.7	0.8	A	0.02	9.2	0.8
	WB	A	0.00	7.8	0.0	A	0.01	7.8	0.0
	NB	B	0.02	11.2	0.0	C	0.02	19.6	0.8
	SB	B	0.07	11.3	1.5	C	0.20	20.9	5.3
	Overall	A	-	1.5	-	-	A	-	1.5
Gladstone Avenue & Bayswater Avenue <i>Signalized</i>	EB	A	0.31	11.3	27.8	A	0.23	8.5	19.8
	WB	A	0.23	8.9	18.4	D	0.85	25.5	#121.1
	NB	A	0.28	13.8	22.9	A	0.52	20.7	41.7
	SB	A	0.42	16.0	33.3	B	0.61	23.0	49.3
	Overall	A	0.35	12.7	-	-	C	0.75	21.8
Somerset Street W & Breezehill Avenue <i>Unsignalized</i>	EB	-	-	-	-	-	-	-	-
	WB	A	0.01	8.2	0.0	A	0.02	8.7	0.8
	NB	B	0.08	12.5	2.3	C	0.12	17.7	3.0
	Overall	A	-	1.0	-	-	A	-	1.0
Laurel Street & Breezehill Avenue <i>Unsignalized</i>	EB	A	0.06	7.5	1.5	A	0.04	7.3	0.8
	WB	A	0.03	7.3	0.8	A	0.04	7.4	0.8
	NB	A	0.09	7.5	2.3	A	0.06	7.5	1.5
	SB	A	0.09	7.5	2.3	A	0.10	7.3	2.3
	Overall	A	-	7.5	-	-	A	-	7.4

Notes: Saturation flow rate of 1800 veh/h/lane
Queue is measured in metres
Peak Hour Factor = 0.90

Delay = average vehicle delay in seconds
m = metered queue
= volume for the 95th %ile cycle exceeds capacity

During both the AM and PM peak hours, the study area intersection operates well. No capacity issues are noted. The eastbound movements at the intersection of Gladstone Avenue and Preston Street may exhibit extended queues during AM peak. During the PM peak, the westbound queues at the Gladstone Avenue and Preston Street intersection may extend beyond the mid-block and to Rochester Street, and at the Gladstone Avenue and Bayswater Avenue intersection may extend beyond the Breezehill Avenue intersection.

2.2.8 Collision Analysis

Collision data have been acquired from the City of Ottawa open data website (data.ottawa.ca) for the recent five years for the surrounding study area road network. Table 3 summarizes the collision types and conditions in the study area, Figure 10 illustrates the intersections and segments analyzed, and Table 4 summarizes the total collisions for each of these locations. Collision data are included in Appendix D.

Table 3: Study Area Collision Summary, 2016-2020

		Number	%
Total Collisions		63	100%
Classification	Fatality	0	0%
	Non-Fatal Injury	25	40%
	Property Damage Only	38	60%
Initial Impact Type	Approaching	1	2%
	Angled	17	27%
	Rear end	12	19%
	Sideswipe	6	10%
	Turning Movement	13	21%
	SMV Unattended	4	6%
	SMV Other	8	13%
	Other	2	3%
Road Surface Condition	Dry	38	60%
	Wet	11	17%
	Loose Snow	4	6%
	Slush	6	10%
	Packed Snow	1	2%
	Ice	3	5%
Pedestrian Involved		7	11%
Cyclists Involved		7	11%

Figure 10: Study Area Collision Records – Representation of 2016-2020

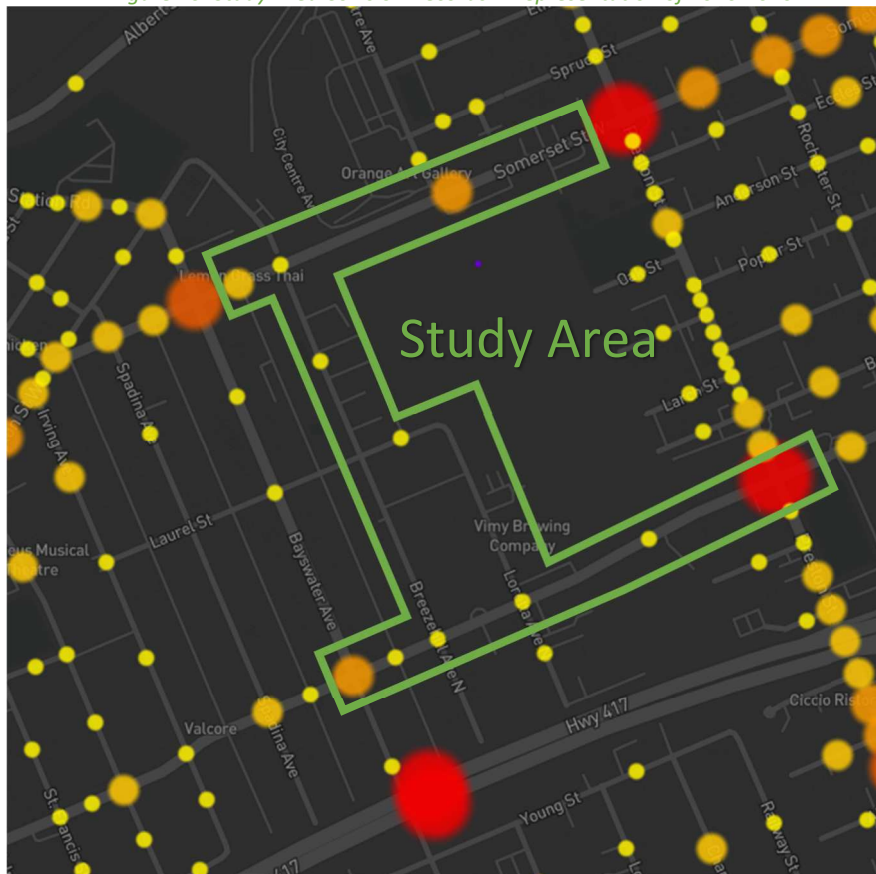

Table 4: Summary of Collision Locations, 2016-2020

Intersections / Segments	Number	%
	63	100%
Gladstone Avenue @ Bayswater Avenue	14	22%
Gladstone Avenue @ Breezehill Avenue	3	5%
Gladstone Avenue @ Loretta Avenue	1	2%
Gladstone Avenue @ Preston Street	19	30%
Gladstone Avenue btwn Bayswater Avenue & Breezehill Avenue N	2	3%
Gladstone Avenue btwn Loretta Avenue N & Preston Street	3	5%
Gladstone Avenue btwn Breezehill Avenue & Loretta Avenue	1	2%
Somerset Street W btwn Bayswater Avenue & Breezehill Avenue N	7	11%
Somerset Street W btwn Breezehill Avenue N & Preston Street	11	17%
Breezehill Avenue N btwn Somerset Street W & Laurel Street	1	2%
Laurel Street btwn Breezehill Avenue N & Loretta Avenue N	1	2%

Within the study area, the intersection of Gladstone Avenue at Bayswater Avenue and Gladstone Avenue at Preston Street, and the segment of Somerset Street W between Breezehill Avenue and Preston Street are noted to have experienced higher collisions than other intersections. Table 5, Table 6 and Table 7 summarize the collision types and conditions for each of these locations.

Table 5: Gladstone Avenue and Bayswater Avenue Collision Summary

Total Collisions		Number	%
		14	100%
Classification	Fatality	0	0%
	Non-Fatal Injury	5	36%
	Property Damage Only	9	64%
Initial Impact Type	Angle	5	35%
	Rear end	4	29%
	Turning Movement	3	21%
	SMV Other	2	14%
Road Surface Condition	Dry	9	64%
	Wet	2	14%
	Loose Snow	2	14%
	Packed Snow	1	7%
Pedestrian Involved		2	14%
Cyclists Involved		0	0%

The Gladstone Avenue and Bayswater Avenue intersection had a total of 14 collisions during the 2016-2020 time period, with nine involving property damage only and the remaining five having non-fatal injuries. The collision types are most represented by angled (five collisions) and rear-end (four collisions) and the remaining split between turning movement and single motor vehicle. The angled collisions may be subject to weather conditions as two are loose snow and one was wet weather conditions. Weather conditions do not affect collisions at this location. No other patterns are noted within the collision data and no mitigation is recommended.

Table 6: Gladstone Avenue and Preston Street Collision Summary

Total Collisions		Number	%
		19	100%
Classification	Fatality	0	0%
	Non-Fatal Injury	9	47%
	Property Damage Only	10	53%
Initial Impact Type	Angle	2	10%

		Number	%
Total Collisions		19	100%
	Rear end	6	32%
	Sideswipe	2	10%
	Turning Movement	4	21%
	SMV Other	5	26%
Road Surface Condition	Dry	9	47%
	Wet	4	21%
	Loose Snow	1	4%
	Slush	3	16%
	Ice	2	10%
Pedestrian Involved		4	21%
Cyclists Involved		2	10%

The Gladstone Avenue and Preston Street intersection had a total of 19 collisions during the 2016-2020 time period, with 10 involving property damage only and the remaining nine having non-fatal injuries. The collision types are most represented by rear-end (six collisions), SMV other (five collisions), and sideswipe, turning movement and angled with four or less each. Pedestrian and bicycles were involved in 31% of the collisions at the intersection and this aligns with the safety review completed by the City in 2020 for this intersection. Intersection improvements were recommended to include buffered/protected cycling approaches to the intersection, thermoplast bike crossing markings, truck aprons to reduce turn radii and reducing all approaches to single shared movement lanes. Weather conditions do not affect collisions at this location. No further review is required as part of this study.

Table 7: Somerset Street W between Breezehill Avenue and Preston Street Collision Summary

		Number	%
Total Collisions		11	100%
Classification	Fatality	0	0%
	Non-Fatal Injury	6	45%
	Property Damage Only	5	55%
Initial Impact Type	Angle	3	27%
	Sideswipe	3	27%
	Turning Movement	4	36%
	SMV Unattended	1	9%
Road Surface Condition	Dry	9	79%
	Wet	2	21%
Pedestrian Involved		0	0%
Cyclists Involved		5	55%

The Somerset Street W segment between Breezehill Avenue and Preston Street had a total of 11 collisions during the 2016-2020 time period, with five involving property damage only and six having non-fatal injuries. The collision types are evenly distributed with turning movements with four each, sideswipe and angled with three each and a single unattended vehicle. The collisions are assumed to be a result of the on-street parking and commercial/retail access located on the east side of the Trillium Line overpass, through a combination of parked cars, dooring, loading vehicles, infrequent access traffic and the Plant Recreation Centre access. This area also has shared road cycling facilities, where as the overpass has bike lanes west to Breezehill Avenue, and likely contributes to the cycling collision frequency of approximately one per year. Weather conditions do not affect collisions at this location. No further review is required as part of this study although the City should initiate a review for potential

mitigation along Somerset Street, similar to the intersection study done for Somerset Street and Bayswater Avenue.

2.3 Planned Conditions

2.3.1 Changes to the Area Transportation Network

The subject development is within the Gladstone Station District CDP (2014) and as such, is subject to the development and planning vision outlined with the CDP. The CDP visioning option for the transit-oriented development node, illustrated in Figure 11, has the following new transportation infrastructure elements:

- Trillium LRT station plaza identified as a node/landmark/gateway for the community (estimated 2023)
- a multi-use crossing is proposed over the rail line between Gladstone Avenue and Laurel Street W
- a new road connection across the rail line between Laurel Street W and Oak Street

Beyond the station plaza, these improvements are not identified in the City's affordable network and no time frame is available for their construction.

Figure 11: Gladstone Station District CDP Vision & Concept Options Report – Preferred Option: Perspective Looking North-East

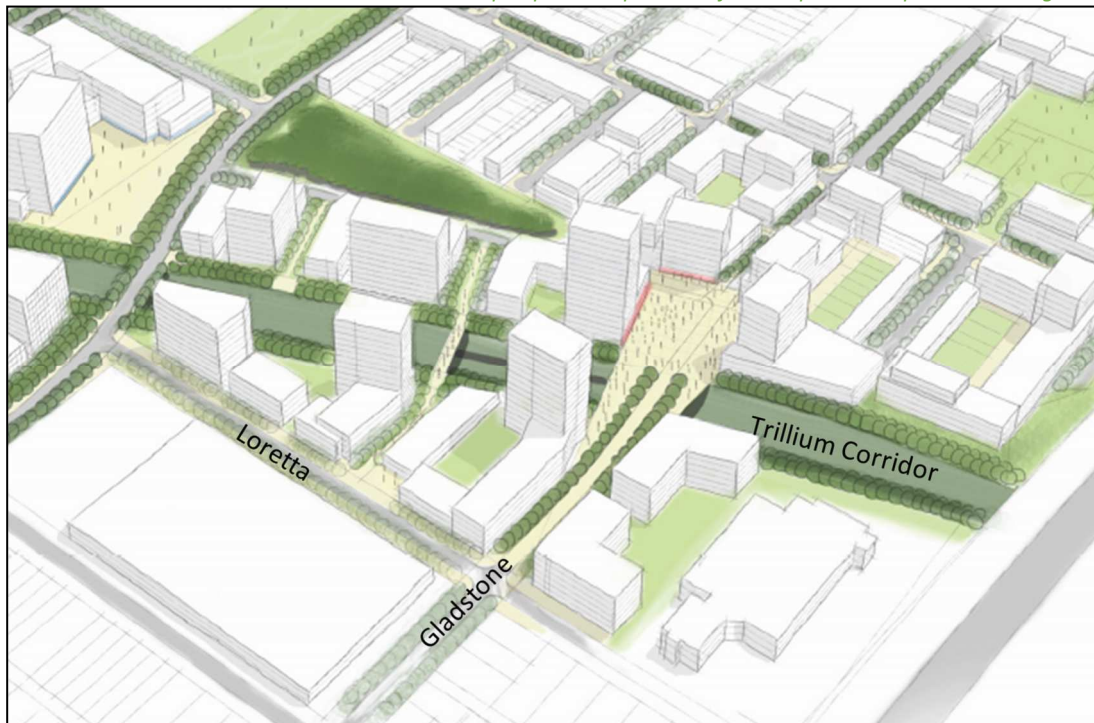

The Loretta Avenue N reconstruction will be undertaken by the City in 2023 to replace aging infrastructure. As part of this reconstruction, raised crossings will be included on Gladstone Avenue for the north side and south side crossings at Loretta Avenue N.

2.3.2 Other Study Area Developments

The following developments were available on Ottawa's devapps service at the time of this study. Files added subsequently should include this site within their background conditions.

1040 and 1050 Somerset Street

The combined site would include a 32-storey residential building between the Trillium Rail corridor and Breezhill Avenue, and a 23-storey residential building on the west side of Breezhill Avenue. Both sites would include

ground floor commercial/retail and provide underground parking. Access to the 1040 site was proposed along Breezehill Avenue and a laneway access on Somerset Street West was proposed for the 1050 site. This application file has not advanced since 2013.

989 Somerset Street

The proposed development consists of a mixed-use building with ground floor retail and 127 residential units above. The transportation impact of this site will be primarily on Somerset Street West and Preston Street. In addition, this file has not advanced since 2014.

975 Gladstone Avenue

An addition to the existing Canada Bank Note building is proposed on the rear of the building, consisting of 947m² warehousing space and a 177m² secure interior loading bay. The planning rationale states that the addition supports the existing light industrial business and not generate any increase of vehicular trips.

139-143 Balsam Street and 20 Larch Street

The proposed demolish control applications was submitted to remove the existing buildings on site. The properties would remain in an interim condition until such time redevelopment occurs in accordance with the Gladstone Station CDP.

3 Study Area and Time Periods

3.1 Study Area

The study area will include the intersections of:

- Gladstone Avenue at:
 - Bayswater Avenue
 - Breezehill Avenue
 - Loretta Avenue
 - Preston Street
- Breezehill Avenue at:
 - Laurel Street
 - Somerset Street
- Loretta Avenue at:
 - Site Access #1
 - Site Access #2 (outbound)
 - Site Access #3

The boundary roads will be Gladstone Avenue and Loretta Avenue. The TRANS screenline SL-29 was reviewed during the zoning bylaw amendment application and no issues were noted. No additional screenline analysis will be provided within this TIA.

3.2 Time Periods

As the proposed development is composed predominantly by residential and office, the AM and PM peak hours will be examined.

3.3 Horizon Years

The anticipated build-out year is 2026. As a result, the full build-out plus five years horizon year is 2031.

4 Exemption Review

Table 8 summarizes the exemptions for this TIA.

Table 8: Exemption Review

Module	Element	Explanation	Exempt/Required
Design Review Component			
4.1 Development Design	4.1.2 Circulation and Access	Only required for site plans	Required
	4.2.3 New Street Networks	Only required for plans of subdivision	Exempt
4.2 Parking	4.2.1 Parking Supply	Only required for site plans	Required
	4.2.2 Spillover Parking	Only required for site plans where parking supply is 15% below unconstrained demand	Exempt
Network Impact Component			
4.5 Transportation Demand Management	All Elements	Not required for site plans expected to have fewer than 60 employees and/or students on location at any given time	Required
4.6 Neighbourhood Traffic Management	4.6.1 Adjacent Neighbourhoods	Only required when the development relies on local or collector streets for access and total volumes exceed ATM capacity thresholds	Required
4.8 Network Concept		Only required when proposed development generates more than 200 person-trips during the peak hour in excess of equivalent volume permitted by established zoning	Exempt (site plan matches new zoning)

5 Development-Generated Travel Demand

5.1 Mode Shares

Examining the mode shares recommended in the TRANS Trip Generation Manual (2020) for the subject district, derived from the most recent National Capital Region Origin-Destination survey (OD Survey), the existing average district mode shares by land use for Ottawa West have been summarized in Table 9.

Table 9: TRANS Trip Generation Manual Recommended Mode Shares – Ottawa West

Travel Mode	Multi-Unit (High-Rise)		Commercial Generator		Employment Generator
	AM	PM	AM	PM	AM and PM
Auto Driver	28%	33%	55%	50%	54%
Auto Passenger	11%	11%	11%	16%	8%
Transit	41%	26%	11%	11%	28%
Cycling	3%	7%	0%	5%	5%
Walking	16%	23%	23%	18%	5%
Total	100%	100%	100%	100%	100%

Since the site is being within the TOD area, a higher transit mode is considered achievable at this location. A 24% shift to transit mode from the auto driver mode and six percent shift from the auto passenger mode is proposed for both residential and non-residential land uses. The modified mode share targets are proposed for the development and are summarized in Table 10.

Table 10: Proposed Development Mode Shares

Travel Mode	Multi-Unit (High-Rise)		Commercial Generator		Employment Generator
	AM	PM	AM	PM	AM and PM
Auto Driver	10%	15%	37%	32%	36%
Auto Passenger	5%	5%	5%	10%	2%
Transit	65%	50%	35%	35%	52%
Cycling	3%	7%	0%	5%	5%
Walking	16%	23%	23%	18%	5%
Total	100%	100%	100%	100%	100%

5.2 Trip Generation

This TIA has been prepared using the vehicle and person trip rates for the residential dwellings using the TRANS Trip Generation Manual (2020) and the vehicle trip rates and derived person trip rates for commercial component from the ITE Trip Generation Manual 11th Edition (2021) using the City-prescribed conversion factor of 1.28. Table 11 summarizes the person trip rates for the proposed residential land uses for each peak period and the person trip rates for the non-residential land uses by peak hour.

Table 11: Trip Generation Person Trip Rates

Land Use	Land Use Code	Peak Period	Vehicle Trip Rate	Person Trip Rates	Note
Multi-Unit High-Rise	221 & 222 (TRANS)	AM	-	0.80	-
		PM	-	0.90	
Land Use	Land Use Code	Peak Hour	Vehicle Trip Rate	Person Trip Rates	Note
General Office	710 (ITE)	AM	1.52	1.95	Fitted Curve
		PM	1.48	1.89	
Strip Retail Plaza (<40k)	822 (ITE)	AM	2.36	3.02	Average Rate
		PM	6.59	8.44	

Using the above person trip rates, the total person trip generation has been estimated. Table 12 summarizes the total person trip generation for the residential land uses and for the non-residential land uses.

Table 12: Total Development Person Trip Generation

Land Use	Units	AM Peak Period			PM Peak Period		
		In	Out	Total	In	Out	Total
Multi-Unit (High-Rise)	872	216	482	698	455	330	785
Land Use	GFA	AM Peak Hour			PM Peak Hour		
		In	Out	Total	In	Out	Total
General Office	198,524	341	46	387	64	311	375
Strip Retail Plaza (<40k)	17,611	32	21	53	75	75	149

Internal capture rates from the ITE Trip Generation Handbook 3rd Edition have been assigned to the development's retail component for mixed-use developments. The rates summarized in Table 13 represent the percentage of trips to/from the office and retail use based on the residential component.

Table 13: Internal Capture Rates

Land Use	AM		PM	
	In	Out	In	Out
Residential to/from General Office	3%	1%	57%	2%
Residential to/from Shopping Centre	17%	14%	10%	26%

Using the above mode share targets for a TOD area, the internal capture, and the person trip rates, the person trips by mode have been projected. Trip generation by peak hour has been forecasted using the prescribed peak period conversion factors presented in the TRANS Trip Generation Manual (2020) for the residential component. Table 14 summarizes the residential trip generation and the non-residential trip generation by mode and peak hour.

Table 14: Trip Generation by Mode

Travel Mode		AM Peak Hour				PM Peak Hour			
		Mode Share	In	Out	Total	Mode Share	In	Out	Total
Multi-Unit (High-Rise)	Auto Driver	10%	10	24	34	15%	29	23	52
	Auto Passenger	5%	5	12	17	5%	10	7	17
	Transit	65%	75	175	250	50%	104	81	185
	Cycling	3%	4	8	12	7%	15	11	26
	Walking	16%	20	46	65	23%	53	41	94
	Total	100%	114	265	378	100%	211	163	374
General Office	Auto Driver	36%	119	17	136	36%	10	110	120
	Auto Passenger	2%	7	1	8	2%	1	6	7
	Transit	52%	172	24	196	52%	15	159	174
	Cycling	5%	17	2	19	5%	1	15	16
	Walking	5%	17	2	19	5%	1	15	16
	<i>Internal Capture</i>	<i>varies</i>	<i>-10</i>	<i>0</i>	<i>-10</i>	<i>varies</i>	<i>-36</i>	<i>-6</i>	<i>-42</i>
Total	100%	332	46	378	100%	28	305	333	
Strip Retail Plaza (<40k)	Auto Driver	37%	10	7	17	32%	21	18	39
	Auto Passenger	5%	1	1	2	10%	7	6	12
	Transit	35%	9	6	15	35%	23	19	42
	Cycling	0%	0	0	0	5%	3	3	6
	Walking	23%	6	4	10	18%	12	10	22
	<i>Internal Capture</i>	<i>varies</i>	<i>-5</i>	<i>-3</i>	<i>-8</i>	<i>varies</i>	<i>-8</i>	<i>-20</i>	<i>-28</i>
Total	100%	26	18	45	100%	66	56	121	
Total	Auto Driver	-	139	48	187	-	60	151	211
	Auto Passenger	-	13	14	27	-	18	19	36
	Transit	-	256	205	461	-	142	259	401
	Cycling	-	21	10	31	-	19	29	48
	Walking	-	43	52	94	-	66	66	132
	Total	-	472	329	801	-	305	524	828

As shown above, a total of 187 AM and 211 PM new peak hour two-way vehicle trips are projected as a result of the proposed development.

5.3 Trip Distribution

To understand the travel patterns of the subject development the OD Survey has been reviewed to determine the travel patterns for the Ottawa West area. Table 15 below summarizes the distributions.

Table 15: OD Survey Distribution

To/From	Ottawa West	Routing
North	5%	via Somerset (2.5% east and west)
South	30%	via Gladstone (15% west), Preston (15% south)
East	30%	via Gladstone (15% east), Preston (5% south), Preston (5% north), Gladstone (5% west to Hwy 417)

To/From	Ottawa West	Routing
West	35%	via Laurel (5%) west, Somerset (5% west), Gladstone (25% west)
Total	100%	

Note: internal trips applied to west direction

5.4 Trip Assignment

Using the distribution outlined above, turning movement splits, and access to major transportation infrastructure, the trips generated by the site have been assigned to the study area road network. Figure 12 illustrates the new site generated volumes.

Figure 12: New Site Generation Auto Volumes

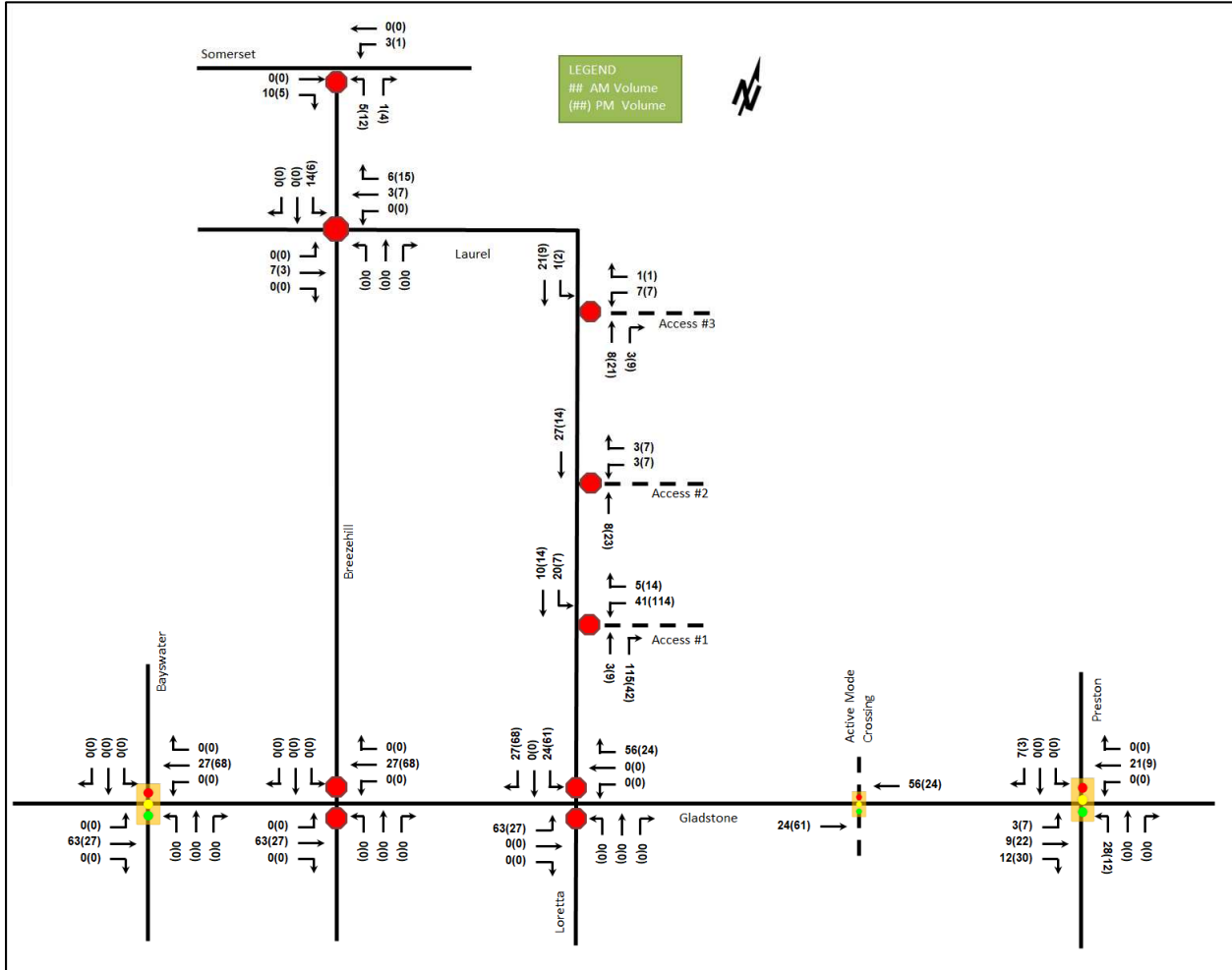

6 Background Network Travel Demands

6.1 Transportation Network Plans

The transportation network plans were discussed in Section 2.3.1. Beyond the opening of the Trillium LRT Corso Italia, no additional network changes have been included in the preparation of this TIA.

6.2 Background Growth

The auto demand within the inner area of Ottawa has been documented as decreasing over the past 10 years, resulting in reduced demand on many roadways. As such, no growth has been applied to the study area intersections. This is consistent with the zoning bylaw amendment TIA.

6.3 Other Developments

No background developments were explicitly considered as part of this TIA as no active files were documented within the area at the time. The future background traffic volumes are anticipated to remain the same as the existing conditions and no improvements are recommended.

7 Demand Rationalization

7.1 Modal Share Sensitivity

No capacity constraints have been noted at the study area intersections. As this development is targeted for a transit focus and meets the planned context of this area, rationalization for adjusted demand is not required for this TIA.

8 Development Design

8.1 Design for Sustainable Modes

The proposed development is a mixed-use development, with four surface parking spaces and 522 underground parking spaces. It is anticipated that 68 surface parking and 694 underground parking spaces will be provided. A total of 22 surface bicycle parking spaces are provided on the west and south side of the retail/office building southwest of the parcel, eight spaces are located next to the surface parking, 12 spaces are located on the north side of Tower 2, eight spaces are located on the west side of Tower 2, two spaces are located on the northwest side of Tower 3, and 16 spaces are located on the west side of Tower 3, with the remainder located underground in the bike storage rooms. The access to the bicycle storage area on P1 is via the MUP on the west side of the Trillium LRT line.

As part of the site plan, the plaza located between Towers 2 and 3 will provide access to the MUP on the west side of the Trillium LRT line, and the area between the Standard Bread and Trillium LRT line will be reconstructed as a pedestrian plaza for active mode connectivity to Corso Italia.

The infrastructure TDM checklist is provided in Appendix E.

8.2 Circulation and Access

Vehicle access is provided via a two-way access on Loretta Avenue to the Towers 1 and 2 loading and underground garage and a one-way loop to the north that exits onto Loretta Avenue. The two-way access is 8.0m wide and the one-way loop is 6.7m wide. The one-way loop is designated as the fire route within the site. Additionally, an access is provided to Tower 3 for loading and underground garage from Loretta Avenue, and this access is 6.0m wide. The garbage trucks are anticipated to enter via Access 3 and exit by reversing. All proposed accesses meet the Private Approach Bylaw widths.

According to the Private Approach By-law, a maximum of one two-way private approach and two one-way private approaches or two two-way private approaches are permitted along the 150-metre frontage of Loretta Avenue. Although not meeting the by-law requirements, the additional one-way access (Access #2) is outbound only and will operate only for drop-off/pick-up and as a fire lane, and is expected to generate six auto trips during the AM

peak hour and 14 trips during the PM peak hour. The additional one-way access (Access #2) is considered to have a negligible impact to the roadway and is a low volume driveway that improves the site operations for a transit focused site. With respect to the existing condition, this will be a reduction from the four two-way accesses and uncontrolled perpendicular parking along the street edge. The proposed condition will result in a more structured operation in line with driver expectation along a local roadway. It is recommended that the access be approved by the City.

The pedestrian and active mode access is provided along Gladstone Avenue for the Standard Bread building, retail components, and through connection into the site. Along Loretta Avenue, the lobby accesses are all located on the one-way loop.

The garbage truck, move in truck and fire truck turning movements can be accommodated on site. The turning templates are provided in Appendix F.

9 Parking

9.1 Parking Supply

The site provides a total of 526 vehicle parking spaces, which include 436 spaces for residential use, 46 spaces for office and existing buildings, 14 spaces for retail, and 30 visitor parking spaces. There are four surface vehicle parking spaces and 522 underground vehicle parking spaces in total. According to the zoning by-law, the maximum vehicle parking for the site is 1,991 parking spaces, with no minimum required for a TOD zone. The minimum requirement for visitor parking on the site is 30 spaces. The proposed vehicle parking spaces meet the bylaw requirements of maximum vehicle parking and minimum visitor parking.

The site provides a total of 694 bicycle parking spaces, including 68 surface parking and 694 underground parking spaces. According to the zoning by-law, the minimum bicycle parking for the site is 436 residential bicycle parking spaces and 80 office/retail parking spaces. The proposed bicycle parking exceeds the bylaw requirements.

10 Boundary Street Design

Table 16 summarizes the MMLOS analysis for the boundary streets of Gladstone Avenue and Loretta Avenue N. The Gladstone Avenue existing and future conditions will be the same and are considered in one row and the Loretta Avenue N will be split between existing and future conditions. The boundary street analysis is based on the policy area of “within 600m of a rapid transit station”. The MMLOS worksheets has been provided in Appendix G.

Table 16: Boundary Street MMLOS Analysis

Segment	Pedestrian LOS		Bicycle LOS		Transit LOS		Truck LOS	
	PLOS	Target	BLOS	Target	TLOS	Target	TrLOS	Target
Gladstone Avenue	C	A	D	B	D	D	-	-
Loretta Avenue North (existing)	F	A	B	D	-	-	-	-
Loretta Avenue North (future)	A	A	B	D	-	-	-	-

Gladstone Avenue and the existing Loretta Avenue N segments do not meet the pedestrian MMLOS target. Gladstone Avenue would require reduced traffic and a boulevard of 0.5m or greater to meet the PLOS A target. The addition of a sidewalk and landscaping along the Loretta Avenue N frontage will meet the PLOS target.

Gladstone Avenue segment does not meet the bicycle MMLOS target. To meet the target, operating speed has to be reduced to less or equal to 40 km/h.

11 Access Intersections Design

11.1 Location and Design of Access

The vehicle access will be located along Loretta Avenue N on a two-way driveway to the underground ramp, and a one-way loop will extend north to exit onto Loretta Avenue N. A two-way driveway to the underground ramp for Tower 3 located at the north of the site. Access #1 is located approximately 55 metres north of Gladstone Avenue and will be 8.0 metres wide to accommodate all turning movements, and the Access #2 is located approximately 105 metres north of Gladstone Avenue and will be 6.7 metres wide, permitting left and right turn lanes. Access #3 is located approximately 4 metres south of the northern property limit and is 6.0 metres wide.

The access is located approximately 55 metres from Gladstone Avenue, and it is five metres less than the Private Approach Bylaw Section 25(m)(ii) requirement of 60 metres. It is noted that the TAC Geometric Design Guidelines minimum clearance for a private driveway on local road is 15 metres, therefore, the 57 metres offset is considered sufficient. It is recommended that that access location meets TAC standards and can be approved by the City.

According to Section 25(m)(ii) of the Private Approach Bylaw, a minimum distance of 60 meters is required between a two-way private approach and any other private approach. Additionally, the TAC Geometric Design Guidelines recommend minimum 1.0 metre spacing between the ends of curb returns for adjacent low-volume driveways in residential areas along local roadways and 3.0 meters for commercial land uses. The distance between Access #1 and Access #2 is 28.5 metres, and the distance between Access #2 and Access #3 is 43.5 metres. Although the distances between accesses do not meet the Private Approach Bylaw requirements, given that Access #2 is an outbound-only, and both Access #2 and Access #3 are expected low volumes, the distances between accesses are beyond the TAC requirements and considered sufficient. It is recommended that that access location meets TAC standards and can be approved by the City.

Section 25(1)(p) of the Private Approach By-law requires a 3.0 metres off-set between the end of the curb return and the property line. The access is located appropriately within the site to have a 3.0-metre offset from the property line, although due to truck movements, the curb radii does end near the adjacent parcel access (131 Loretta Avenue). The offset distance between the radii and adjacent access is expected to be approximately 1.0-metres once the Loretta Renewal is completed. It is noted that the adjacent access does not provide any separation from the property line in its current state. Should this parcel redevelop, a greater separation can be expected through revisions to the access location. As the access is at approximately the TAC minimums, it is recommended that the access can be approved by the City.

Access #1 throat length is approximately 7.4 metres to the turn of the one-way loop radius and 20.7 metres to the first parking stall. Access #2 throat length is approximately 7.3 metre from the property line to the end the turn of the one-way loop radius and 26.2 metres to the first parking space. The Access #3 provides approximately 11.2 metres from the property line to the loading door.

11.2 Intersection Control

All accesses will include stop sign controls and one-way signage will be provided at the Access #2 location.

11.3 Access Intersection Design

11.3.1 Future Total Access Intersection Operations

The future total intersection volumes are illustrated in Figure 13 and the access intersection operations are summarized below in Table 17. Synchro 11 has been used to model the unsignalized intersections and the HCM

2010 methodology was used for unsignalized intersection operations. The synchro worksheets have been provided in Appendix H.

Figure 13: Future Total Volumes

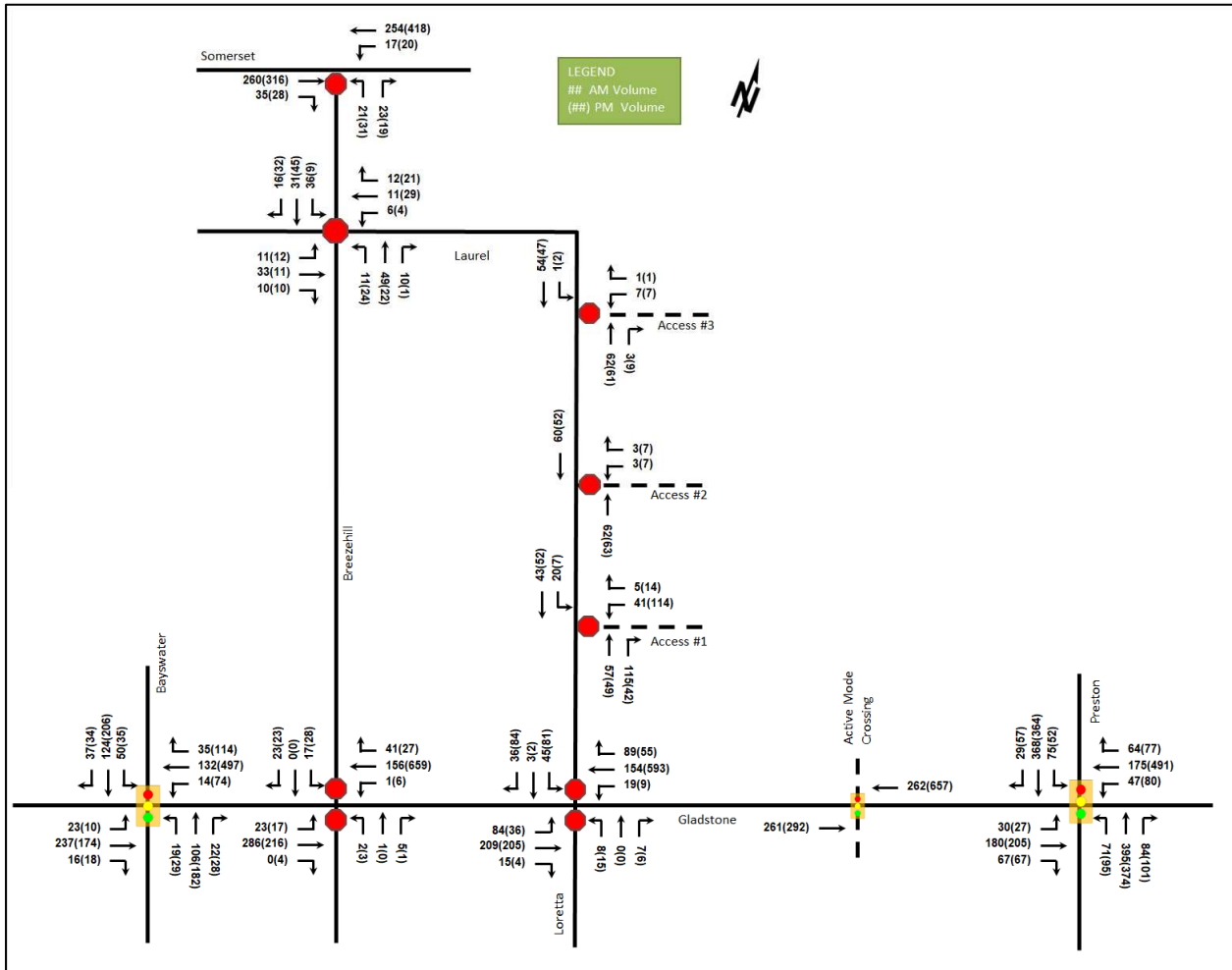

Table 17: Future Total Access Intersection Operations

Intersection	Lane	AM Peak Hour				PM Peak Hour			
		LOS	V/C	Delay	Q (95th)	LOS	V/C	Delay	Q (95th)
Access #1 & Loretta Avenue N Unsignalized	WBL/R	A	0.06	9.8	1.5	A	0.15	9.9	3.8
	NBT/R	-	-	-	-	-	-	-	-
	SBL/T	A	0.01	7.6	0.0	A	0.01	7.4	0.0
	Overall	A	-	2.1	-	A	-	4.7	-
Access #2 & Loretta Avenue N Unsignalized	WBL/R	A	0.01	8.9	0.0	A	0.02	8.9	0.0
	NBT	-	-	-	-	-	-	-	-
	SBT	-	-	-	-	-	-	-	-
	Overall	A	-	0.4	-	A	-	1.0	-
Access #3 & Loretta Avenue N Unsignalized	WBL/R	A	0.01	9.1	0.0	A	0.01	9.1	0.0
	NBT/R	-	-	-	-	-	-	-	-
	SBL/T	A	0.00	7.3	0.0	A	0.00	7.4	0.0
	Overall	A	-	0.6	-	A	-	0.7	-

Notes: Saturation flow rate of 1800 veh/h/lane
 Queue is measured in metres
 Peak Hour Factor = 1.00

m = metered queue
 # = volume for the 95th %ile cycle exceeds capacity

The access intersection operations for the future total horizon operate well.

11.3.2 Access Intersection MMLoS

No signalized intersections are used to access the proposed site.

11.3.3 Recommended Design Elements

The recommended access design elements remain consistent with City of Ottawa standards for access design for depressed curbs through the access locations and depressed sidewalks crossing the accesses.

12 Transportation Demand Management

12.1 Context for TDM

The mode shares used within the TIA represent the planning level targets for a transit-oriented design (TOD) as the site is located within the Gladstone Station TOD design priority area.

For the residential land use, total bedrooms are estimated to be 1,209 and no age restrictions are noted. The retail and office land uses will be determined by lease options and are entirely dependant on tenants to determine the number and occupation of employees, and clients/customers travelling from the Ottawa-Gatineau area and within 2.0km of the site. It is noted that the existing tenants of the site may continue to stay and rent the provided retail/office space.

12.2 Need and Opportunity

The subject site has been assumed to rely predominantly on transit due to the proximity to the future Gladstone LRT Station. The development is planned to coincide with the Corso Italia construction. The convenience of the transit station should provide the opportunity to reach the forecast transit mode share, although incentives for new residential tenants exists within the TDM framework. Hard measures, such as reduced parking provisions, would limit the risk of higher auto mode shares being produced from the site.

12.3 TDM Program

The “suite of post occupancy TDM measures” has been summarized in the TDM checklists for both the residential and non-residential land uses. The checklist is provided in Appendix E.

The key TDM measures recommended include:

- Enhanced connectivity of pedestrians and cyclists to the adjacent network and adjacent Gladstone LRT station
- Engagement with local bike share programs (e.g., VeloGO) to include onsite space for bike rack/storage
- Posting of pedestrian, cycling, and transit information and maps at primary entrances/exits
- Unbundle parking cost from purchase or rental costs
- Inclusion of a 1-year Presto card for first time new residential tenants, along with a set time frame for this offer (e.g., 6-months) from the ‘opening’ of the building/tower

The City and the proponent may engage beyond the scope of the TIA process to confirm the elements and conditions required as part of the site plan approvals.

13 Neighbourhood Traffic Management

Gladstone Avenue is a major collector road and has a 600-vehicle threshold for two-way traffic volumes per the City’s TIA Guidelines. The existing Gladstone Avenue volumes exceed this threshold in both segments to the east and west of Loretta Avenue N by at least 140 percent. The site traffic will increase the two-way vehicles by 57- 85

to the east of the site and 64-95 vehicles to the west of the site. The overall increase is not considered significant within the context of the existing Gladstone Avenue traffic. If a reduction is required to meet the TIA thresholds, the City will be required to explore options to reduce Gladstone Avenue volumes by 250-300 vehicles during the peak hours.

Along Loretta Avenue N, the existing volumes are below the local road thresholds of 120 two-way vehicles. The segment of Loretta Avenue N from Gladstone Avenue to the outbound site access will exceed the local road threshold with the addition of the site traffic and the segment north of the site will remain below the threshold. As the segment between Gladstone Avenue and the site accesses will not have any accesses or adjacent land uses that would be negatively affected by the volumes and no mitigation is recommended. It is noted that the MMLOS analysis meets the area targets for Loretta Avenue N.

14 Transit

14.1 Route Capacity

In Section 5.1 the trip generation by mode was estimated, including an estimate of the number of transit trips that will be generated by the proposed development. Table 18 summarizes the transit trip generation.

Table 18: Trip Generation by Transit Mode

Travel Mode	Mode Share	AM Peak Hour			PM Peak Hour		
		In	Out	Total	In	Out	Total
Transit	Varies	256	205	461	142	259	401

The proposed development is anticipated to generate an additional 339 AM peak hour transit trips and 289 PM peak hour transit trips. From the trip distribution found in Section 5.3, these values can further be broken down, and Table 19 summarized the transit ridership by direction and equivalent bus loads.

Table 19: Forecasted Site-Generated Transit Ridership

Direction	AM Peak Hour		PM Peak Hour		Service Type	Approximate Equivalent Peak Hour/Direction Bus Loads
	In	Out	In	Out		
North	13	9	6	13	LRT	-
South	77	62	43	78	LRT	-
East	77	62	43	78	Bus, LRT	One and one-third of a standard bus
West	89	72	50	90	Bus, LRT	One and half of a standard bus

The City has indicated that the Trillium line can accommodate the additional ridership demand. If a maximum of 10% of the transit mode share utilizes the existing route #14, this may see the need for two additional single bus (55-person capacity) during the peak hours to accommodate the additional demand.

14.2 Transit Priority

No transit priority is required explicitly for this study.

15 Network Intersection Design

15.1 Network Intersection Control

No change to the existing signalized control is recommended for the network intersections. A signal warrant was completed for the Gladstone Avenue and Loretta Avenue N intersection and is provided in Appendix I.

15.2 Network Intersection Design

15.2.1 Future Total Network Intersection Operations

The future total network intersection operations are summarized below in Table 20. The level of service for signalized intersections is based on the v/c calculation for individual lane movements and HCM 2000 v/c calculations for the overall intersection, and HCM average delay for unsignalized intersections. The synchro worksheets have been provided in Appendix H.

Table 20: Future Total Network Intersection Operations

Intersection	Lane	AM Peak Hour				PM Peak Hour			
		LOS	V/C	Delay	Q (95th)	LOS	V/C	Delay	Q (95th)
Gladstone Avenue & Preston Street <i>Signalized</i>	EB	C	0.73	36.7	27.7	B	0.63	21.6	56.9
	WBL	A	0.23	21.8	11.7	A	0.23	16.2	16.2
	WBT/R	A	0.56	24.6	40.0	D	0.88	37.4	#123.9
	NBL	A	0.15	9.6	11.5	A	0.33	17.5	18.4
	NBT/R	A	0.51	11.9	64.9	B	0.64	19.7	72.9
	SBL	A	0.19	10.4	12.6	A	0.20	15.0	10.7
	Overall	A	0.57	18.1	-	C	0.75	24.5	-
Gladstone Avenue & Active Mode Crossing <i>Signalized</i>	EB	A	0.18	3.6	17.9	A	0.21	3.6	20.3
	WB	A	0.19	2.1	15.3	A	0.46	3.1	m28.9
	Overall	A	0.17	2.9	-	A	0.43	3.3	-
Gladstone Avenue & Loretta Avenue North <i>Unsignalized</i>	EB	A	0.07	8.0	1.5	A	0.04	9.2	0.8
	WB	A	0.01	7.8	0.0	A	0.01	7.8	0.0
	NB	B	0.03	13.2	0.8	C	0.10	23.5	2.3
	SB	B	0.19	14.7	5.3	D	0.57	32.4	24.8
	Overall	A	-	3.4	-	A	-	5.8	-
Gladstone Avenue & Breezehill Avenue <i>Unsignalized</i>	EB	A	0.02	7.8	0.8	A	0.02	9.2	0.8
	WB	A	0.00	7.9	0.0	A	0.01	7.8	0.0
	NB	B	0.01	11.6	0.0	C	0.02	19.5	0.0
	SB	B	0.07	11.6	1.5	C	0.18	20.7	5.3
	Overall	A	-	1.3	-	A	-	1.4	-
Gladstone Avenue & Bayswater Avenue <i>Signalized</i>	EB	A	0.36	12.0	32.8	A	0.24	8.7	20.7
	WB	A	0.24	9.4	19.8	D	0.84	24.8	#120.0
	NB	A	0.25	13.2	20.6	A	0.47	19.6	37.4
	SB	A	0.37	15.1	29.6	A	0.55	21.3	43.5
	Overall	A	0.36	12.4	-	C	0.73	20.9	-
Somerset Street W & Breezehill Avenue <i>Unsignalized</i>	EB	-	-	-	-	-	-	-	-
	WB	A	0.02	8.1	0.0	A	0.02	8.6	0.8
	NB	B	0.08	12.4	2.3	C	0.15	17.4	3.8
	Overall	A	-	1.1	-	A	-	1.2	-
Laurel Street & Breezehill Avenue <i>Unsignalized</i>	EB	A	0.06	7.5	1.5	A	0.04	7.3	0.8
	WB	A	0.03	7.3	0.8	A	0.06	7.3	1.5
	NB	A	0.08	7.5	2.3	A	0.06	7.5	1.5
	SB	A	0.10	7.6	2.3	A	0.10	7.4	2.3
	Overall	A	-	7.5	-	A	-	7.4	-

Notes: Saturation flow rate of 1800 veh/h/lane
Queue is measured in metres
Peak Hour Factor = 1.00

m = metered queue
= volume for the 95th %ile cycle exceeds capacity

The network intersection operations for the future total conditions operate similarly to the existing conditions. A slight increase in operations is noted due to the peak hour factor of 1.00 applied when compared to the existing conditions.

15.2.2 Network Intersection MMLoS

Table 21 summarizes the MMLoS analysis for the signalized network intersections and the existing and future conditions for are assumed to be the same and are considered in one row. The intersection analysis is based on the policy area of “within 600m of a rapid transit station”, which has the same targets as “within 330m of a school”. The MMLoS worksheets has been provided in Appendix G.

Table 21: Study Area Intersection MMLoS Analysis

Intersection	Pedestrian LOS		Bicycle LOS		Transit LOS		Truck LOS		Auto LOS	
	PLOS	Target	BLOS	Target	TLOS	Target	TrLOS	Target	ALOS	Target
Gladstone Avenue & Preston Street	E	A	D	B	E	D	E	D	C	E
Gladstone Avenue & Bayswater Avenue	D	A	B	B	D	D	-	-	C	E

The MMLoS targets will not be met for the pedestrian at both intersections and bicycle LOS, transit LOS, and truck LOS at the Gladstone Avenue and Preston Street intersection.

To meet the PLOS targets, the intersection of Gladstone Avenue and Bayswater Avenue could meet the area targets on the east and west sides of the intersection with a signage change to prohibit right-turns on red, and on the north and south sides of the intersection through protected left-turns on Gladstone Avenue or a combination of zebra hi-vis crossing markings and the prohibition of right-turns on red. These are considered City improvements and can be reviewed internally for potential implementation.

At the intersection of Gladstone Avenue and Preston Street, the PLOS cannot be met due to arterial road intersection limitations. It would require reconstruction of the intersection to reduce all pedestrian crossing distances to approximately 7.0 metres and include the additional implementation of on of the following items: protected left-turns, right-turn on red prohibition or raised pedestrian crossings. The bicycle LOS would require operating speed to be reduced to less than 40 km/h, the transit LOS would require delay to be reduced to below 30 seconds on all transit approach movements, and the truck LOS would require additional receiving lanes or corner radii to be increased to greater than 15 metres to meet the targets. No improvements are recommended for this intersection to meet the MMLoS targets.

15.2.3 Recommended Design Elements

No study area intersection design elements are proposed as part of this study.

16 Summary of Improvements Indicated and Modifications Options

The following summarizes the analysis and results presented in this TIA report:

Proposed Site and Screening

- The proposed site plan application consists of approximately 872 residential units, 198,524 sq. ft of office space (including the existing Standard Bread building, live-work space) and 17,611 sq. ft of retail space
- Four existing accesses and street edge parking will be removed and replaced with a new two-way general access between Towers 1 and 2, with a one-way loop extending past Tower 2 to Loretta Avenue North and a two-way access for Tower 3

- A pedestrian plaza is proposed at the corner of the development adjacent to Gladstone Avenue and the Trillium LRT corridor
- The development is proposed to be completed by 2026
- The trip generation and location triggers were met for the TIA Screening

Existing Conditions

- Preston Street and Somerset Street W are arterial roads, Gladstone Avenue is a major collector road, and Bayswater Avenue is a collector road in the study area
- Sidewalks are generally provided on both sides of the study area roadways, with the exception of limited facilities along Loretta Avenue, no sidewalks on Laurel Street to the east of Breezehill Avenue and on the east side of Breezehill Avenue between Laurel Street and Gladstone Avenue
- Bike lanes are provided on Somerset Street W over the Trillium LRT corridor and Gladstone Avenue, Bayswater Avenue and Somerset Street W are suggested bike routes
- The Trillium Pathway runs along the east side of the Trillium LRT corridor
- The existing transit route #14 travels along Gladstone Avenue, route #11 along Somerset Street W and #85 along Preston Street
- No operational issues are noted for the study area intersections
- The study area intersections with higher collisions were reviewed and no specific mitigation recommendations are noted for the Gladstone Avenue and Bayswater Avenue intersection or Gladstone Avenue and Preston Street intersection, but additional review may be required by the City for Somerset Street W between Breezehill Avenue and Preston Street for cycling collisions

Development Generated Travel Demand

- The proposed development is forecasted produce 677 two-way people trips during the AM peak hour and 829 two-way people trips during the PM peak hour
- Of the forecasted people trips, 142 two-way trips will be vehicle trips during the AM peak hour and 211 two-way trips will be vehicle trips during the PM peak hour
- Of the forecasted people trips, 398 two-way trips will be transit trips during the AM peak hour and 400 two-way trips will be transit trips during the PM peak hour
- Of the forecasted trips, 35% are anticipated to travel west, 30% to the east and south, and 5% to the north

Background Conditions

- Adjacent developments have either been on hold for extended periods of time with an unknown horizon, or are too small to have a noticeable impact on the adjacent road network
- Additionally, the background growth in the Ottawa core has been decreasing and a 0% growth was assumed for the area
- The future background intersection operations are the same as the existing intersections

Development Design

- Bicycle parking is provided on the east and south side of the retail/office building southeast of the parcel, on the south side of Tower 3, with the remainder located underground in the bike storage rooms
- Pedestrian connections will be made along Gladstone Avenue and Loretta Avenue N, and a connection to the Trillium LRT corridor MUP will be made between Towers 2 and 3 and at the Gladstone Avenue pedestrian plaza to the LRT station

- Despite not meeting the maximum number of accesses specified in the Private Approach By-law, the one-way access (Access #2) is projected to have a negligible impact, and the proposed accesses will result in a more structured operation in line with driver expectations along a local roadway compared to the existing condition. Therefore, it is recommended that the access be approved by the City
- The one-way loop is designated as the fire route within the site
- Vehicle access is provided via a two-way access on Loretta Avenue to the Towers 1 and 2 loading and underground garage and a one-way loop to the north that exits onto Loretta Avenue. Additionally, vehicle access is available via a two-way access on Loretta Avenue to Towers 3 for loading and underground garage and exit by reversing
- The garbage truck, move in truck and fire truck turning movements can be accommodated on site

Parking

- The site provides a total of 526 vehicle parking spaces, which include 436 spaces for residential use, 46 spaces for office and existing buildings, 14 spaces for retail, and 30 visitor parking spaces
- The site provides a total of 694 bicycle parking spaces, including 68 surface parking and 694 underground parking spaces
- The proposed parking spaces meet the bylaw requirements of maximum vehicle parking, minimum visitor parking, and minimum bicycle parking

Boundary Street Design

- The boundary streets will not meet pedestrian MMLOS targets along Gladstone Avenue and the existing Loretta Avenue N, due to auto volumes and lack of boulevard space along Gladstone Avenue and no sidewalk currently provided along the frontage of Loretta Avenue N
- The addition of the sidewalk and boulevard on Loretta Avenue N will meet the pedestrian targets once the site is developed
- Gladstone Avenue segment does not meet the bicycle MMLOS target, which requires reduction of operating speed to be less or equal to 40 km/h

Access Intersections Design

- The accesses will require depressed curbs through the access locations and depressed sidewalks crossing the accesses
- All accesses will include stop sign controls and one-way signage will be provided at the Access #2 location
- The access is located beyond the TAC requirements for a private driveway on a local road and it is recommended the City approve the location

TDM

- Supportive TDM measures to be included within the proposed development should include:
 - Enhanced connectivity of pedestrians and cyclists to the adjacent network and adjacent Gladstone LRT station
 - Engagement with local bike share programs (e.g., VeloGO) to include onsite space for bike rack/storage
 - Posting of pedestrian, cycling, and transit information and maps at primary entrances/exits
 - Unbundle parking cost from purchase or rental costs

- Inclusion of a 1-year Presto card for first time new residential tenants, along with a set time frame for this offer (e.g., 6-months) from the 'opening' of the building/tower
- The City and the proponent may engage beyond the scope of the TIA process to confirm the elements and conditions required as part of the site plan approvals

Neighbourhood Traffic Management

- Gladstone Avenue currently exceeds the City's TIA Guideline thresholds for a major collector road, and the City would be required to reduce the two-way traffic along Gladstone Avenue by 250-300 vehicles during the peak hours to achieve the prescribed thresholds
- Loretta Avenue N is currently under the City's TIA Guideline thresholds for a local road and is projected to remain under the threshold to the north upon the site build-out
- Between Gladstone Avenue and the outbound access of the one-way loop is forecasted to exceed the City's TIA Guideline thresholds for a local road, and due to limited impacts along the segment, no mitigation is recommended

Transit

- The City has confirmed the forecasted transit use/ridership can be accommodated on the Trillium LRT line
- Two additional single buses during the peak hours may be needed to accommodate the additional demand
- No specific transit priority measures were considered as part of this development

Network Intersection Design

- Generally, the network intersections will operate similarly to the existing conditions
- The MMLOS targets will not be met for the pedestrian LOS at the Gladstone Avenue intersections at Bayswater Avenue and at Preston Street, the transit LOS and truck LOS at Preston Street
- At the intersection of Gladstone Avenue and Bayswater Avenue, the prohibition of right-turns on read for all approaches and the addition of zebra hi-vis crossing markings on the north and south sides of the intersection would be required to meet the pedestrian LOS, and are considered the responsibility of the City to implement should they require
- The bicycle LOS would require operating speed to be reduced to less than 40 km/h at the intersection of Gladstone Avenue and Preston Street
- The transit LOS would require delay to be reduced to below 30 seconds on all transit approach movements, and the truck LOS would require additional receiving lanes or corner radii to be increased to greater than 15 metres at the intersection of Gladstone Avenue and Preston Street
- No mitigation is recommended for the Gladstone Avenue and Preston Street intersection as reconstruction would be required to meet the pedestrian LOS targets and the truck LOS targets directly conflict with achieving the pedestrian LOS targets

17 Conclusion

It is recommended that, from a transportation perspective, the proposed development applications proceed.

Prepared By:



Yu-Chu Chen
Transportation Engineering-Intern

Reviewed By:



Andrew Harte, P.Eng.
Senior Transportation Engineer

Appendix A

TIA Screening Form and PM Certification Form

City of Ottawa 2017 TIA Guidelines
Step 1 - Screening Form

Date: 08-Apr-21
Project Number: 2020-25
Project Reference: 951 Gladstone & 145 Loretta

1.1 Description of Proposed Development	
Municipal Address	951 Gladstone Ave, 145 Loretta Ave N
Description of Location	Existing general industrial or retail/commercial uses, including the Standard Bread Building
Land Use Classification	Pending rezoning to Mixed-Use Centre
Development Size	Apartments: 843 units, Office: 198,165 sq. ft, Retail: 17,611 sq.ft (includes Standard Bread Building)
Accesses	One-way loop and garbage/move-in access on Loretta
Phase of Development	Single Phase
Buildout Year	2026
TIA Requirement	Full TIA Required

1.2 Trip Generation Trigger	
Land Use Type	Townhomes or apartments
Development Size	843 Units
Trip Generation Trigger	Yes

1.3 Location Triggers	
Does the development propose a new driveway to a boundary street that is designated as part of the City's Transit Priority, Rapid Transit or Spine Bicycle Networks?	No
Is the development in a Design Priority Area (DPA) or Transit-oriented Development (TOD) zone?	Yes
Location Trigger	Yes

1.4. Safety Triggers	
Are posted speed limits on a boundary street 80 km/hr or greater?	No
Are there any horizontal/vertical curvatures on a boundary street limits sight lines at a proposed driveway?	No
Is the proposed driveway within the area of influence of an adjacent traffic signal or roundabout (i.e. within 300 m of intersection in rural conditions, or within 150 m of intersection in urban/ suburban conditions)?	No
Is the proposed driveway within auxiliary lanes of an intersection?	No
Does the proposed driveway make use of an existing median break that serves an existing site?	No
Is there is a documented history of traffic operations or safety concerns on the boundary streets within 500 m of the development?	No
Does the development include a drive-thru facility?	No
Safety Trigger	No



TIA Plan Reports

On 14 June 2017, the Council of the City of Ottawa adopted new Transportation Impact Assessment (TIA) Guidelines. In adopting the guidelines, Council established a requirement for those preparing and delivering transportation impact assessments and reports to sign a letter of certification.

Individuals submitting TIA reports will be responsible for all aspects of development-related transportation assessment and reporting, and undertaking such work, in accordance and compliance with the City of Ottawa's Official Plan, the Transportation Master Plan and the Transportation Impact Assessment (2017) Guidelines.

By submitting the attached TIA report (and any associated documents) and signing this document, the individual acknowledges that s/he meets the four criteria listed below.

CERTIFICATION

1. I have reviewed and have a sound understanding of the objectives, needs and requirements of the City of Ottawa's Official Plan, Transportation Master Plan and the Transportation Impact Assessment (2017) Guidelines;
2. I have a sound knowledge of industry standard practice with respect to the preparation of transportation impact assessment reports, including multi modal level of service review;
3. I have substantial experience (more than 5 years) in undertaking and delivering transportation impact studies (analysis, reporting and geometric design) with strong background knowledge in transportation planning, engineering or traffic operations; and
4. I am either a licensed¹ or registered² professional in good standing, whose field of expertise [check appropriate field(s)] is either transportation engineering or transportation planning .

1,2 License of registration body that oversees the profession is required to have a code of conduct and ethics guidelines that will ensure appropriate conduct and representation for transportation planning and/or transportation engineering works.

City Of Ottawa
Infrastructure Services and Community
Sustainability
Planning and Growth Management
110 Laurier Avenue West, 4th fl.
Ottawa, ON K1P 1J1
Tel. : 613-580-2424
Fax: 613-560-6006

Ville d'Ottawa
Services d'infrastructure et Viabilité des
collectivités
Urbanisme et Gestion de la croissance
110, avenue Laurier Ouest
Ottawa (Ontario) K1P 1J1
Tél. : 613-580-2424
Télécopieur: 613-560-6006

Dated at Ottawa this 20 day of September, 2018.
(City)

Name: Andrew Harte
(Please Print)

Professional Title: Professional Engineer

Signature of Individual certifier that s/he meets the above four criteria

Office Contact Information (Please Print)
Address: 6 Plaza Court
City / Postal Code: Ottawa / K2H 7W1
Telephone / Extension: (613) 697-3797
E-Mail Address: Andrew.Harte@CGHTransportation.com



Appendix B

Turning Movement Count Data



Transportation Services - Traffic Services W.O. 36100
Turning Movement Count - 15 Minute Summary Report

BAYSWATER AVE @ GLADSTONE AVE

Survey Date: Wednesday, July 27, 2016

Total Observed U-Turns
 Northbound: 0 Southbound: 0
 Eastbound: 0 Westbound: 0

BAYSWATER AVE										GLADSTONE AVE										Grand Total
Northbound					Southbound					Eastbound					Westbound					
Time Period	LT	ST	RT	N TOT	LT	ST	RT	S TOT	STR TOT	LT	ST	RT	E TOT	LT	ST	RT	W TOT	STR TOT		
07:00 07:15	0	13	3	16	11	31	6	48	64	5	22	3	30	2	11	6	19	49	113	
07:15 07:30	2	21	2	25	3	23	3	29	54	5	21	3	29	2	18	5	25	54	108	
07:30 07:45	1	19	2	22	10	32	2	44	66	9	24	3	36	3	21	8	32	68	134	
07:45 08:00	2	25	7	34	8	35	5	48	82	5	28	3	36	4	14	4	22	58	140	
08:00 08:15	3	20	5	28	18	30	11	59	87	5	36	1	42	3	19	7	29	71	158	
08:15 08:30	5	32	3	40	8	29	7	44	84	7	28	4	39	1	22	9	32	71	155	
08:30 08:45	3	24	7	34	10	32	15	57	91	5	23	8	36	5	26	10	41	77	168	
08:45 09:00	8	30	7	45	14	33	4	51	96	6	25	3	34	5	38	9	52	86	182	
09:00 09:15	3	27	8	38	9	24	7	40	78	7	28	3	38	5	19	8	32	70	148	
09:15 09:30	4	18	10	32	10	28	9	47	79	3	29	2	34	2	20	8	30	64	143	
09:30 09:45	7	13	8	28	10	14	5	29	57	6	23	5	34	3	21	7	31	65	122	
09:45 10:00	4	12	5	21	9	19	2	30	51	5	24	3	32	1	25	6	32	64	115	
11:30 11:45	4	28	5	37	2	21	5	28	65	2	27	2	31	12	24	10	46	77	142	
11:45 12:00	5	15	14	34	10	23	6	39	73	1	30	3	34	5	46	14	65	99	172	
12:00 12:15	6	25	9	40	8	28	8	44	84	5	28	0	33	7	35	8	50	83	167	
12:15 12:30	6	17	5	28	8	23	13	44	72	4	26	4	34	6	38	15	59	93	165	
12:30 12:45	7	28	10	45	5	18	3	26	71	8	29	4	41	3	27	6	36	77	148	
12:45 13:00	7	27	13	47	10	15	4	29	76	3	26	5	34	7	28	10	45	79	155	
13:00 13:15	3	14	3	20	7	24	4	35	55	4	30	3	37	4	32	16	52	89	144	
13:15 13:30	5	20	8	33	10	17	4	31	64	9	33	4	46	2	38	10	50	96	160	
15:00 15:15	4	48	5	57	10	30	9	49	106	6	32	3	41	7	27	11	45	86	192	
15:15 15:30	2	53	3	58	6	42	8	56	114	8	20	8	36	9	35	26	70	106	220	
15:30 15:45	1	52	7	60	4	38	2	44	104	7	28	2	37	11	60	35	106	143	247	
15:45 16:00	4	46	5	55	8	25	6	39	94	5	25	5	35	9	46	23	78	113	207	
16:00 16:15	6	57	7	70	12	35	10	57	127	11	30	6	47	13	69	33	115	162	289	
16:15 16:30	7	44	3	54	9	47	9	65	119	8	26	1	35	24	66	27	117	152	271	
16:30 16:45	8	44	8	60	5	69	9	83	143	7	26	8	41	11	66	32	109	150	293	
16:45 17:00	8	37	10	55	9	55	6	70	125	4	18	3	25	26	66	22	114	139	264	
17:00 17:15	9	40	2	51	6	58	15	79	130	9	26	6	41	22	57	27	106	147	277	
17:15 17:30	5	36	10	51	9	37	12	58	109	9	23	6	38	16	73	26	115	153	262	
17:30 17:45	3	28	5	36	6	35	8	49	85	11	29	5	45	11	50	13	74	119	204	
17:45 18:00	6	26	9	41	10	28	10	48	89	6	21	2	29	5	38	11	54	83	172	
TOTAL:	148	939	208	1295	274	998	227	1499	2794	195	844	121	1160	246	1175	462	1883	3043	5837	

Note: U-Turns are included in Totals.

Comment:



Transportation Services - Traffic Services
Turning Movement Count - Cyclist Volume Report

Work Order
36100

BAYSWATER AVE @ GLADSTONE AVE

Count Date: Wednesday, July 27, 2016

Start Time: 07:00

Time Period	BAYSWATER AVE			GLADSTONE AVE			Grand Total
	Northbound	Southbound	Street Total	Eastbound	Westbound	Street Total	
07:00 08:00	6	2	8	29	14	43	51
08:00 09:00	12	7	19	63	18	81	100
09:00 10:00	5	0	5	19	15	34	39
11:30 12:30	2	0	2	11	14	25	27
12:30 13:30	2	0	2	10	0	10	12
15:00 16:00	3	4	7	10	9	19	26
16:00 17:00	3	7	10	21	51	72	82
17:00 18:00	11	11	22	35	40	75	97
Total	44	31	75	198	161	359	434

Comment:

Note: These volumes consists of bicycles only (no mopeds or motorcycles) and ARE NOT included in the Turning Movement Count Summary.



Transportation Services - Traffic Services
Turning Movement Count - Full Study Diagram

BAYSWATER AVE @ GLADSTONE AVE

Survey Date: Wednesday, July 27, 2016

WO#: 36100
Device: Miovision

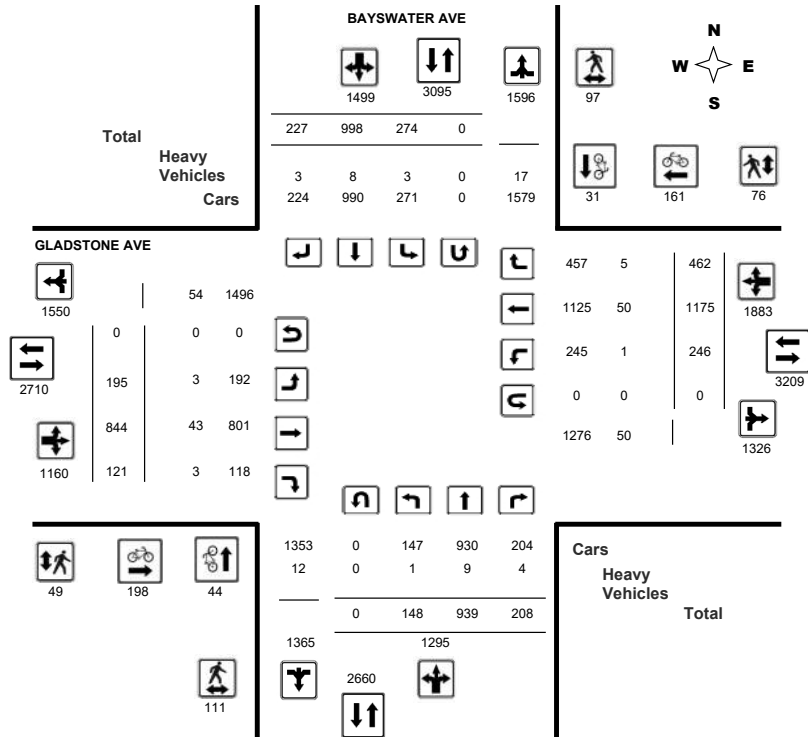

Comments



Transportation Services - Traffic Services

W.O.
36100

Turning Movement Count - Heavy Vehicle Report

BAYSWATER AVE @ GLADSTONE AVE

Survey Date: Wednesday, July 27, 2016

Time Period	BAYSWATER AVE							GLADSTONE AVE							W TOT	STR TOT	Grand Total		
	Northbound			Southbound				Eastbound			Westbound								
	LT	ST	RT	N TOT	LT	ST	RT	S TOT	STR TOT	LT	ST	RT	E TOT	LT				ST	RT
07:00	0	0	1	1	1	1	0	2	3	2	2	0	4	1	8	0	9	13	16
08:00	0	2	0	2	0	3	1	4	6	0	4	2	6	0	7	1	8	14	20
09:00	0	1	0	1	0	1	0	1	2	0	4	0	4	0	5	0	5	9	11
11:30	0	1	3	4	1	0	1	2	6	0	6	0	6	0	8	2	10	16	22
12:30	1	5	0	6	1	2	0	3	9	0	9	1	10	0	9	0	9	19	28
15:00	0	0	0	0	0	0	0	0	0	0	9	0	9	0	3	2	5	14	14
16:00	0	0	0	0	0	0	1	1	1	1	6	0	7	0	6	0	6	13	14
17:00	0	0	0	0	0	1	0	1	1	0	3	0	3	0	4	0	4	7	8
Sub Total	1	9	4	14	3	8	3	14	28	3	43	3	49	1	50	5	56	105	133
U-Turns (Heavy Vehicles)	0			0				0			0				0				
Total	1	9	4	0	3	8	3	14	28	3	43	3	49	1	50	5	56	105	133

Heavy Vehicles include Buses, Single-Unit Trucks and Articulated Trucks. Further, they ARE included in the Turning Movement Count Summary.



Transportation Services - Traffic Services
Turning Movement Count - Pedestrian Volume Report

Work Order
36100

BAYSWATER AVE @ GLADSTONE AVE

Count Date: Wednesday, July 27, 2016 Start Time: 07:00

Time Period	NB Approach (E or W Crossing)	SB Approach (E or W Crossing)	Total	EB Approach (N or S Crossing)	WB Approach (N or S Crossing)	Total	Grand Total
07:00 07:15	1	1	2	0	1	1	3
07:15 07:30	3	0	3	1	0	1	4
07:30 07:45	4	5	9	2	1	3	12
07:45 08:00	3	3	6	1	6	7	13
07:00 08:00	11	9	20	4	8	12	32
08:00 08:15	2	5	7	1	3	4	11
08:15 08:30	5	6	11	1	4	5	16
08:30 08:45	8	2	10	0	0	0	10
08:45 09:00	1	5	6	1	1	2	8
08:00 09:00	16	18	34	3	8	11	45
09:00 09:15	3	5	8	2	0	2	10
09:15 09:30	2	2	4	1	2	3	7
09:30 09:45	4	3	7	2	2	4	11
09:45 10:00	2	1	3	0	3	3	6
09:00 10:00	11	11	22	5	7	12	34
11:30 11:45	1	4	5	0	1	1	6
11:45 12:00	3	0	3	0	4	4	7
12:00 12:15	3	0	3	0	9	9	12
12:15 12:30	4	1	5	2	1	3	8
11:30 12:30	11	5	16	2	15	17	33
12:30 12:45	3	0	3	2	1	3	6
12:45 13:00	5	1	6	0	0	0	6
13:00 13:15	4	1	5	0	2	2	7
13:15 13:30	5	2	7	1	3	4	11
12:30 13:30	17	4	21	3	6	9	30
15:00 15:15	0	1	1	0	1	1	2
15:15 15:30	3	1	4	4	2	6	10
15:30 15:45	4	2	6	1	2	3	9
15:45 16:00	2	2	4	0	3	3	7
15:00 16:00	9	6	15	5	8	13	28
16:00 16:15	6	9	15	3	4	7	22
16:15 16:30	2	1	3	4	0	4	7
16:30 16:45	8	7	15	5	5	10	25
16:45 17:00	11	6	17	1	2	3	20
16:00 17:00	27	23	50	13	11	24	74
17:00 17:15	3	8	11	3	1	4	15
17:15 17:30	1	7	8	3	7	10	18
17:30 17:45	2	3	5	2	5	7	12
17:45 18:00	3	3	6	6	0	6	12
17:00 18:00	9	21	30	14	13	27	57
Total	111	97	208	49	76	125	333

Comment:



Transportation Services - Traffic Services

Work Order
36100

Turning Movement Count - Full Study Summary Report

BAYSWATER AVE @ GLADSTONE AVE

Survey Date: Wednesday, July 27, 2016

Total Observed U-Turns

AADT Factor

Northbound: 0 Southbound: 0
Eastbound: 0 Westbound: 0

.90

Full Study

Period	BAYSWATER AVE								GLADSTONE AVE								WB TOT	STR TOT	Grand Total
	Northbound				Southbound				Eastbound				Westbound						
	LT	ST	RT	NB TOT	LT	ST	RT	SB TOT	STR TOT	LT	ST	RT	EB TOT	LT	ST	RT			
07:00 08:00	5	78	14	97	32	121	16	169	266	24	95	12	131	11	64	23	98	229	495
08:00 09:00	19	106	22	147	50	124	37	211	358	23	112	16	151	14	105	35	154	305	663
09:00 10:00	18	70	31	119	38	85	23	146	265	21	104	13	138	11	85	29	125	263	528
11:30 12:30	21	85	33	139	28	95	32	155	294	12	111	9	132	30	143	47	220	352	646
12:30 13:30	22	89	34	145	32	74	15	121	266	24	118	16	158	16	125	42	183	341	607
15:00 16:00	11	199	20	230	28	135	25	188	418	26	105	18	149	36	168	95	299	448	866
16:00 17:00	29	182	28	239	35	206	34	275	514	30	100	18	148	74	267	114	455	603	1117
17:00 18:00	23	130	26	179	31	158	45	234	413	35	99	19	153	54	218	77	349	502	915
Sub Total	148	939	208	1295	274	998	227	1499	2794	195	844	121	1160	246	1175	462	1883	3043	5837
U Turns	0	0	0	0	0	0	0	0	0	0	0	0	0	0	0	0	0	0	0
Total	148	939	208	1295	274	998	227	1499	2794	195	844	121	1160	246	1175	462	1883	3043	5837
EQ 12Hr	206	1305	289	1800	381	1387	316	2084	3884	271	1173	168	1612	342	1633	642	2617	4229	8113
Note: These values are calculated by multiplying the totals by the appropriate expansion factor.																	1.39		
AVG 12Hr	185	1175	260	1620	343	1248	284	1875	3495	244	1056	151	1451	308	1470	578	2356	3807	7302
Note: These volumes are calculated by multiplying the Equivalent 12 hr. totals by the AADT factor.																	.90		
AVG 24Hr	243	1539	341	2122	449	1636	372	2457	4579	320	1383	198	1901	403	1926	757	3086	4987	9566
Note: These volumes are calculated by multiplying the Average Daily 12 hr. totals by 12 to 24 expansion factor.																	1.31		

Comments:

Note: U-Turns provided for approach totals. Refer to 'U-Turn' Report for specific breakdown.



Transportation Services - Traffic Services

Turning Movement Count - Peak Hour Diagram

BAYSWATER AVE @ GLADSTONE AVE

Survey Date: Wednesday, July 27, 2016
Start Time: 07:00

WO No: 36100
Device: Miovision

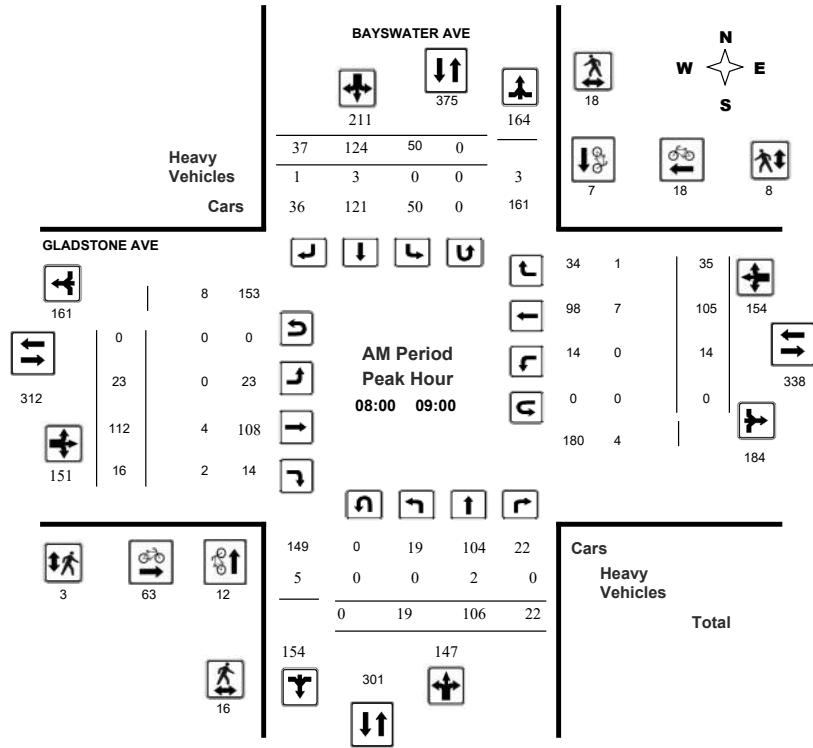

Transportation Services - Traffic Services

Turning Movement Count - Peak Hour Diagram

BAYSWATER AVE @ GLADSTONE AVE

Survey Date: Wednesday, July 27, 2016
Start Time: 07:00

WO No: 36100
Device: Miovision

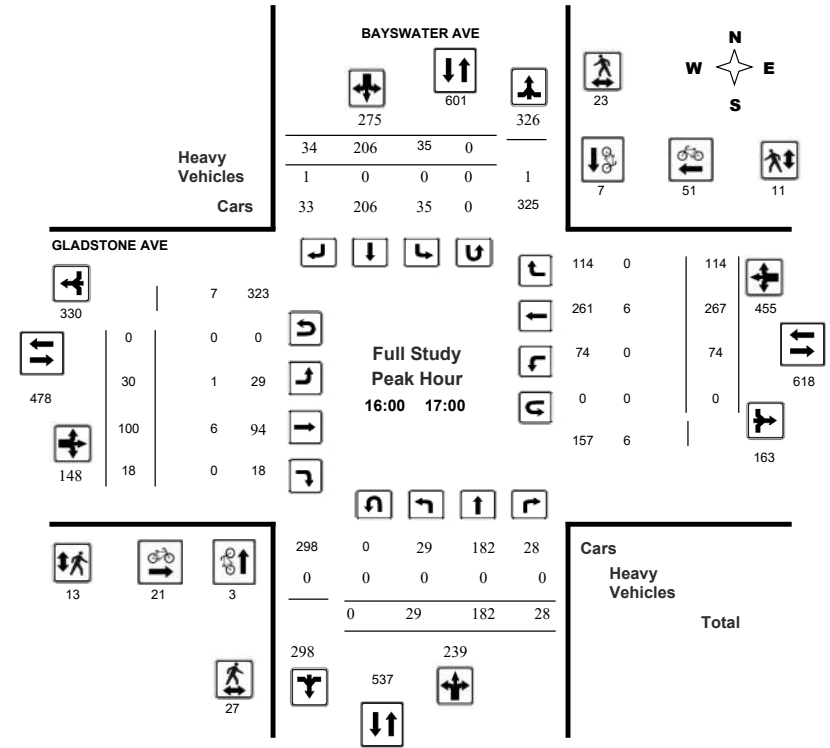



Transportation Services - Traffic Services

Turning Movement Count - Peak Hour Diagram

BAYSWATER AVE @ GLADSTONE AVE

Survey Date: Wednesday, July 27, 2016
Start Time: 07:00

WO No: 36100
Device: Miovision

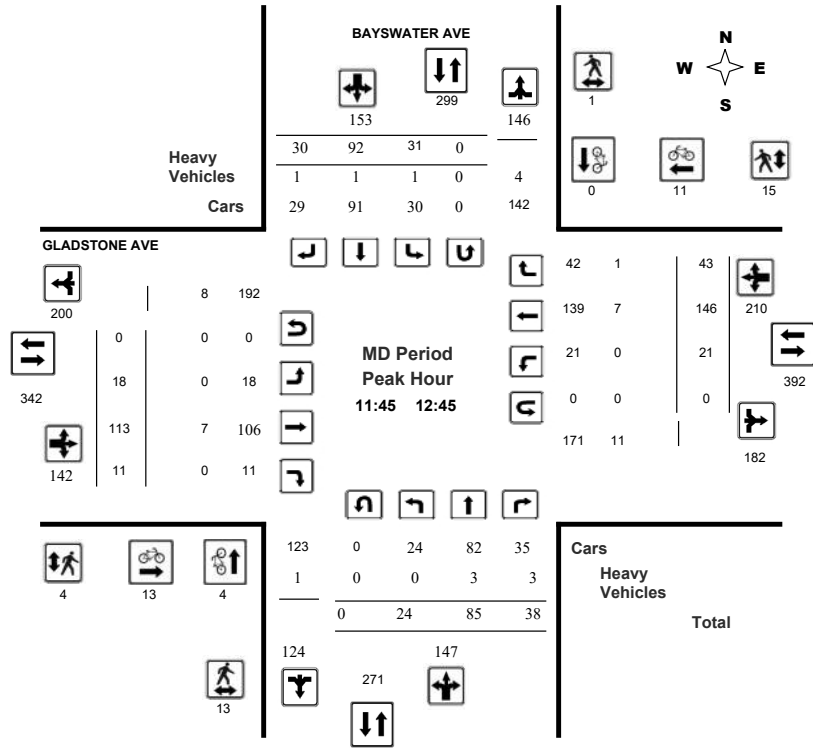

Comments



Transportation Services - Traffic Services

Turning Movement Count - Peak Hour Diagram

BAYSWATER AVE @ GLADSTONE AVE

Survey Date: Wednesday, July 27, 2016
Start Time: 07:00

WO No: 36100
Device: Miovision

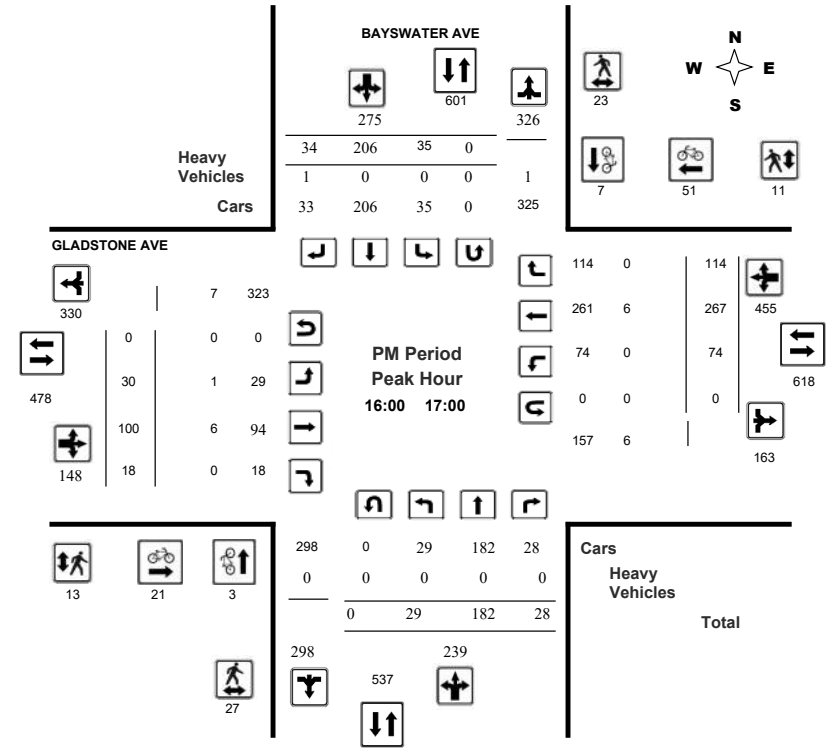

Comments



Transportation Services - Traffic Services

Work Order
36100

Turning Movement Count - 15 Min U-Turn Total Report

BAYSWATER AVE @ GLADSTONE AVE

Survey Date: Wednesday, July 27, 2016

Time Period	Northbound U-Turn Total	Southbound U-Turn Total	Eastbound U-Turn Total	Westbound U-Turn Total	Total
07:00 07:15	0	0	0	0	0
07:15 07:30	0	0	0	0	0
07:30 07:45	0	0	0	0	0
07:45 08:00	0	0	0	0	0
08:00 08:15	0	0	0	0	0
08:15 08:30	0	0	0	0	0
08:30 08:45	0	0	0	0	0
08:45 09:00	0	0	0	0	0
09:00 09:15	0	0	0	0	0
09:15 09:30	0	0	0	0	0
09:30 09:45	0	0	0	0	0
09:45 10:00	0	0	0	0	0
11:30 11:45	0	0	0	0	0
11:45 12:00	0	0	0	0	0
12:00 12:15	0	0	0	0	0
12:15 12:30	0	0	0	0	0
12:30 12:45	0	0	0	0	0
12:45 13:00	0	0	0	0	0
13:00 13:15	0	0	0	0	0
13:15 13:30	0	0	0	0	0
15:00 15:15	0	0	0	0	0
15:15 15:30	0	0	0	0	0
15:30 15:45	0	0	0	0	0
15:45 16:00	0	0	0	0	0
16:00 16:15	0	0	0	0	0
16:15 16:30	0	0	0	0	0
16:30 16:45	0	0	0	0	0
16:45 17:00	0	0	0	0	0
17:00 17:15	0	0	0	0	0
17:15 17:30	0	0	0	0	0
17:30 17:45	0	0	0	0	0
17:45 18:00	0	0	0	0	0
Total	0	0	0	0	0



Transportation Services - Traffic Services

W.O. 37971

Turning Movement Count - 15 Minute Summary Report

BREEZEHILL AVE @ GLADSTONE AVE

Survey Date: Wednesday, July 18, 2018

Total Observed U-Turns

Northbound: 0 Southbound: 0
Eastbound: 0 Westbound: 0

BREEZEHILL AVE										GLADSTONE AVE										Grand Total
Northbound					Southbound					Eastbound					Westbound					
Time Period	LT	ST	RT	N TOT	LT	ST	RT	S TOT	STR TOT	LT	ST	RT	E TOT	LT	ST	RT	W TOT	STR TOT		
07:00 07:15	0	0	0	0	2	0	1	3	3	3	32	0	35	0	18	2	20	55	58	
07:15 07:30	0	0	0	0	1	0	3	4	4	4	28	0	32	0	30	8	38	70	74	
07:30 07:45	0	1	1	2	0	0	3	3	5	3	36	0	39	0	18	4	22	61	66	
07:45 08:00	0	0	1	1	5	1	3	9	10	7	36	0	43	0	35	2	37	80	90	
08:00 08:15	0	0	1	1	4	0	4	8	9	4	40	0	44	0	30	4	34	78	87	
08:15 08:30	0	0	1	1	1	0	7	8	9	10	49	0	59	0	40	8	48	107	116	
08:30 08:45	1	1	0	2	3	0	8	11	13	4	53	0	57	0	42	7	49	106	119	
08:45 09:00	0	0	1	1	2	0	1	3	4	5	60	0	65	1	44	8	53	118	122	
09:00 09:15	1	0	1	2	2	0	2	4	6	4	38	0	42	0	27	14	41	83	89	
09:15 09:30	0	0	0	0	6	0	6	12	12	8	42	0	50	0	46	9	55	105	117	
09:30 09:45	0	0	0	0	9	0	7	16	16	3	35	0	38	2	38	8	48	86	102	
09:45 10:00	2	1	0	3	5	0	5	10	13	9	42	0	51	0	32	1	33	84	97	
11:30 11:45	2	0	1	3	5	0	5	10	13	3	44	0	47	1	39	4	44	91	104	
11:45 12:00	1	0	0	1	7	0	4	11	12	9	43	1	53	1	39	2	42	95	107	
12:00 12:15	1	0	0	1	7	0	7	14	15	7	40	1	48	0	42	6	48	96	111	
12:15 12:30	1	0	1	2	5	0	5	10	12	1	39	3	43	0	48	8	56	99	111	
12:30 12:45	0	1	0	1	8	0	3	11	12	5	36	0	41	0	37	4	41	82	94	
12:45 13:00	0	1	3	4	5	1	5	11	15	5	37	0	42	1	31	1	33	75	90	
13:00 13:15	0	0	0	0	2	0	4	6	6	2	45	0	47	0	49	2	51	98	104	
13:15 13:30	1	0	0	1	2	1	3	6	7	1	39	1	41	1	58	2	61	102	109	
15:00 15:15	2	1	0	3	2	0	6	8	11	2	43	1	46	0	67	5	72	118	129	
15:15 15:30	1	1	1	3	4	0	3	7	10	0	37	0	37	0	87	4	91	128	138	
15:30 15:45	1	1	0	2	7	0	4	11	13	2	39	0	41	0	88	2	90	131	144	
15:45 16:00	0	0	2	2	5	0	7	12	14	4	45	0	49	0	105	5	110	159	173	
16:00 16:15	0	0	0	0	2	0	6	8	8	4	56	1	61	0	103	5	108	169	177	
16:15 16:30	1	0	1	2	10	0	10	20	22	2	56	2	60	2	124	5	131	191	213	
16:30 16:45	0	0	0	0	6	0	2	8	8	8	46	2	56	0	118	9	127	183	191	
16:45 17:00	0	0	0	0	7	0	6	13	13	3	41	0	44	1	133	5	139	183	196	
17:00 17:15	2	0	0	2	5	0	5	10	12	4	44	0	48	3	122	8	133	181	193	
17:15 17:30	1	0	2	3	4	1	2	7	10	0	49	1	50	2	112	3	117	167	177	
17:30 17:45	2	0	1	3	1	0	6	7	10	2	34	2	38	1	114	2	117	155	165	
17:45 18:00	0	0	0	0	6	0	1	7	7	0	30	0	30	0	93	1	94	124	131	
TOTAL:	20	8	18	46	140	4	144	288	334	128	1334	15	1477	16	2009	158	2183	3660	3994	

Note: U-Turns are included in Totals.

Comment:



Transportation Services - Traffic Services
Turning Movement Count - Cyclist Volume Report

Work Order
37971

BREEZEHILL AVE @ GLADSTONE AVE

Count Date: Wednesday, July 18, 2018

Start Time: 07:00

Time Period	BREEZEHILL AVE			GLADSTONE AVE			Grand Total
	Northbound	Southbound	Street Total	Eastbound	Westbound	Street Total	
07:00 08:00	4	1	5	39	23	62	67
08:00 09:00	2	2	4	98	15	113	117
09:00 10:00	0	1	1	29	24	53	54
11:30 12:30	0	0	0	17	11	28	28
12:30 13:30	0	2	2	7	10	17	19
15:00 16:00	1	3	4	26	33	59	63
16:00 17:00	1	3	4	28	49	77	81
17:00 18:00	2	6	8	36	71	107	115
Total	10	18	28	280	236	516	544

Comment:

Note: These volumes consists of bicycles only (no mopeds or motorcycles) and ARE NOT included in the Turning Movement Count Summary.



Transportation Services - Traffic Services
Turning Movement Count - Full Study Diagram

BREEZEHILL AVE @ GLADSTONE AVE

Survey Date: Wednesday, July 18, 2018

WO#: 37971
 Device: Miovision

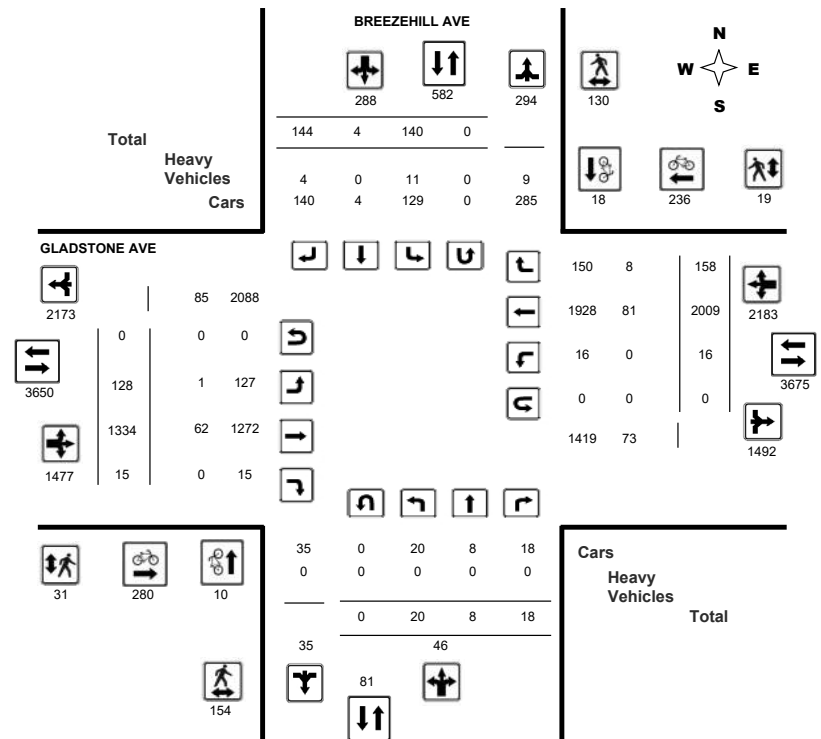

Comments



Transportation Services - Traffic Services

W.O.
37971

Turning Movement Count - Heavy Vehicle Report

BREEZEHILL AVE @ GLADSTONE AVE

Survey Date: Wednesday, July 18, 2018

BREEZEHILL AVE										GLADSTONE AVE										Grand Total
Northbound					Southbound					Eastbound					Westbound					
Time Period	LT	ST	RT	N TOT	LT	ST	RT	S TOT	STR TOT	LT	ST	RT	E TOT	LT	ST	RT	W TOT	STR TOT		
07:00 08:00	0	0	0	0	0	0	1	1	1	0	11	0	11	0	12	1	13	24	25	
08:00 09:00	0	0	0	0	0	0	0	0	0	0	0	11	0	11	0	11	0	11	22	22
09:00 10:00	0	0	0	0	1	0	0	1	1	0	10	0	10	0	12	1	13	23	24	
11:30 12:30	0	0	0	0	4	0	2	6	6	1	9	0	10	0	10	3	13	23	29	
12:30 13:30	0	0	0	0	1	0	1	2	2	0	7	0	7	0	9	0	9	16	18	
15:00 16:00	0	0	0	0	1	0	0	1	1	0	5	0	5	0	6	0	6	11	12	
16:00 17:00	0	0	0	0	3	0	0	3	3	0	7	0	7	0	15	3	18	25	28	
17:00 18:00	0	0	0	0	1	0	0	1	1	0	2	0	2	0	6	0	6	8	9	
Sub Total	0	0	0	0	11	0	4	15	15	1	62	0	63	0	81	8	89	152	167	
U-Turns (Heavy Vehicles)	0	0	0	0	0	0	0	0	0	0	0	0	0	0	0	0	0	0	0	
Total	0	0	0	0	11	0	4	15	15	1	62	0	63	0	81	8	89	152	167	

Heavy Vehicles include Buses, Single-Unit Trucks and Articulated Trucks. Further, they ARE included in the Turning Movement Count Summary.



Transportation Services - Traffic Services

Work Order
37971

Turning Movement Count - Pedestrian Volume Report

BREEZEHILL AVE @ GLADSTONE AVE

Count Date: Wednesday, July 18, 2018

Start Time: 07:00

Time Period	NB Approach (E or W Crossing)	SB Approach (E or W Crossing)	Total	EB Approach (N or S Crossing)	WB Approach (N or S Crossing)	Total	Grand Total
07:00 07:15	6	5	11	1	0	1	12
07:15 07:30	5	3	8	1	1	2	10
07:30 07:45	7	3	10	0	2	2	12
07:45 08:00	2	3	5	0	2	2	7
07:00 08:00	20	14	34	2	5	7	41
08:00 08:15	5	4	9	0	0	0	9
08:15 08:30	8	2	10	3	0	3	13
08:30 08:45	11	6	17	2	1	3	20
08:45 09:00	5	9	14	4	0	4	18
08:00 09:00	29	21	50	9	1	10	60
09:00 09:15	6	3	9	2	1	3	12
09:15 09:30	3	3	6	0	0	0	6
09:30 09:45	1	2	3	2	0	2	5
09:45 10:00	6	3	9	0	0	0	9
09:00 10:00	16	11	27	4	1	5	32
11:30 11:45	7	0	7	0	0	0	7
11:45 12:00	5	1	6	1	0	1	7
12:00 12:15	3	4	7	1	0	1	8
12:15 12:30	6	2	8	0	0	0	8
11:30 12:30	21	14	35	2	0	2	37
12:30 12:45	2	5	7	2	0	2	9
12:45 13:00	2	2	4	1	0	1	5
13:00 13:15	4	3	7	0	0	0	7
13:15 13:30	2	3	5	0	0	0	5
12:30 13:30	10	13	23	3	0	3	26
15:00 15:15	9	3	12	0	0	0	12
15:15 15:30	3	1	4	1	0	1	5
15:30 15:45	6	3	9	0	0	0	9
15:45 16:00	4	7	11	0	0	0	11
15:00 16:00	22	14	36	1	0	1	37
16:00 16:15	2	7	9	0	0	0	9
16:15 16:30	3	7	10	1	5	6	16
16:30 16:45	5	6	11	4	3	7	18
16:45 17:00	7	3	10	0	1	1	11
16:00 17:00	17	23	40	5	9	14	54
17:00 17:15	10	6	16	2	1	3	19
17:15 17:30	5	7	12	0	1	1	13
17:30 17:45	0	2	2	0	1	1	3
17:45 18:00	4	5	9	3	0	3	12
17:00 18:00	19	20	39	5	3	8	47
Total	154	130	284	31	19	50	334

Comment:



Transportation Services - Traffic Services

Turning Movement Count - Peak Hour Diagram

BREEZEHILL AVE @ GLADSTONE AVE

Survey Date: Wednesday, July 18, 2018
Start Time: 07:00

WO No: 37971
Device: Miovision

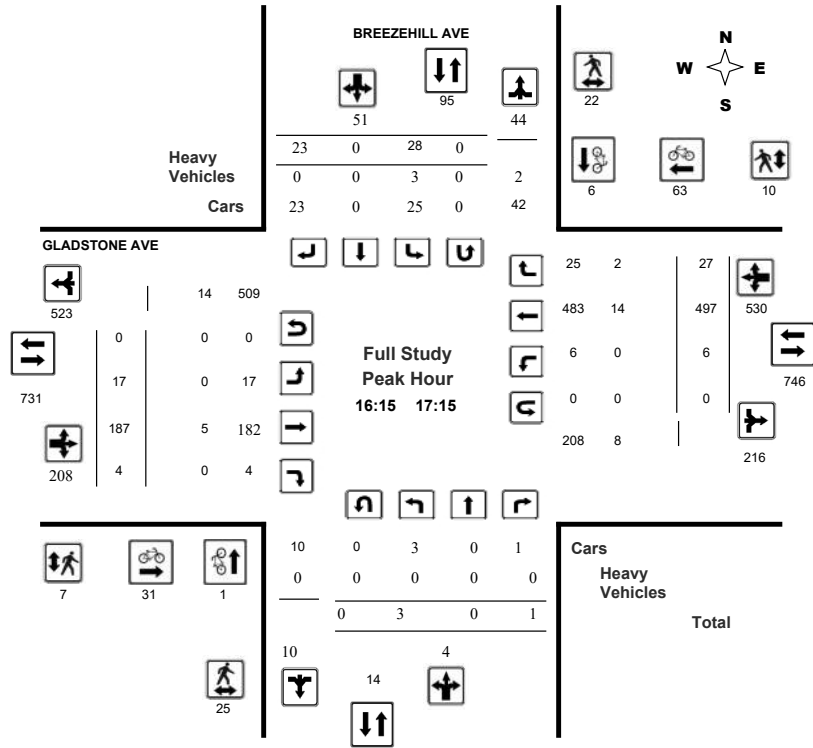

Transportation Services - Traffic Services

Turning Movement Count - Peak Hour Diagram

BREEZEHILL AVE @ GLADSTONE AVE

Survey Date: Wednesday, July 18, 2018
Start Time: 07:00

WO No: 37971
Device: Miovision

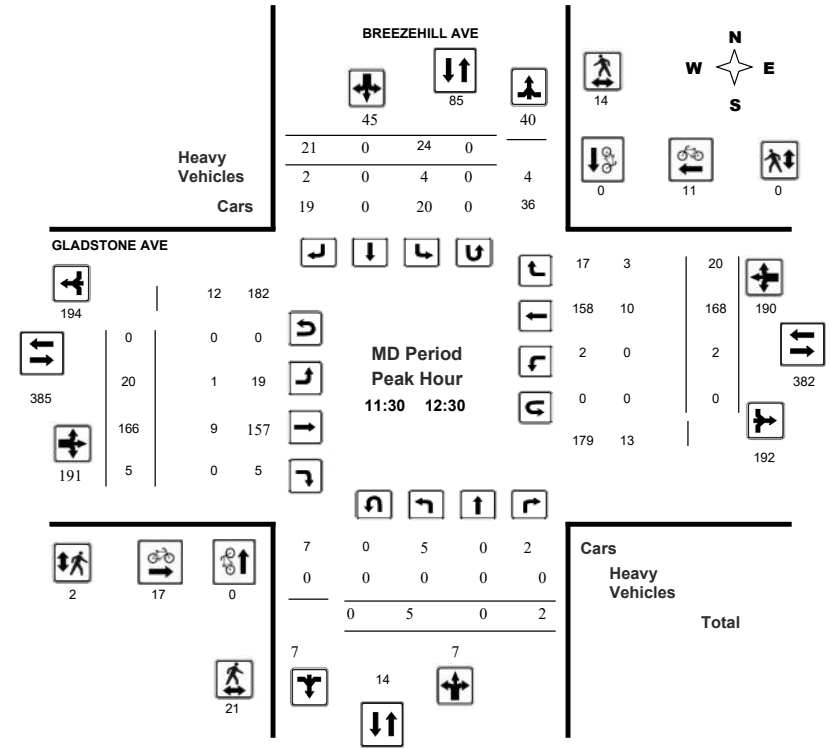



Transportation Services - Traffic Services
Turning Movement Count - Peak Hour Diagram
BREEZEHILL AVE @ GLADSTONE AVE

Survey Date: Wednesday, July 18, 2018
 Start Time: 07:00

WO No: 37971
 Device: Miovision

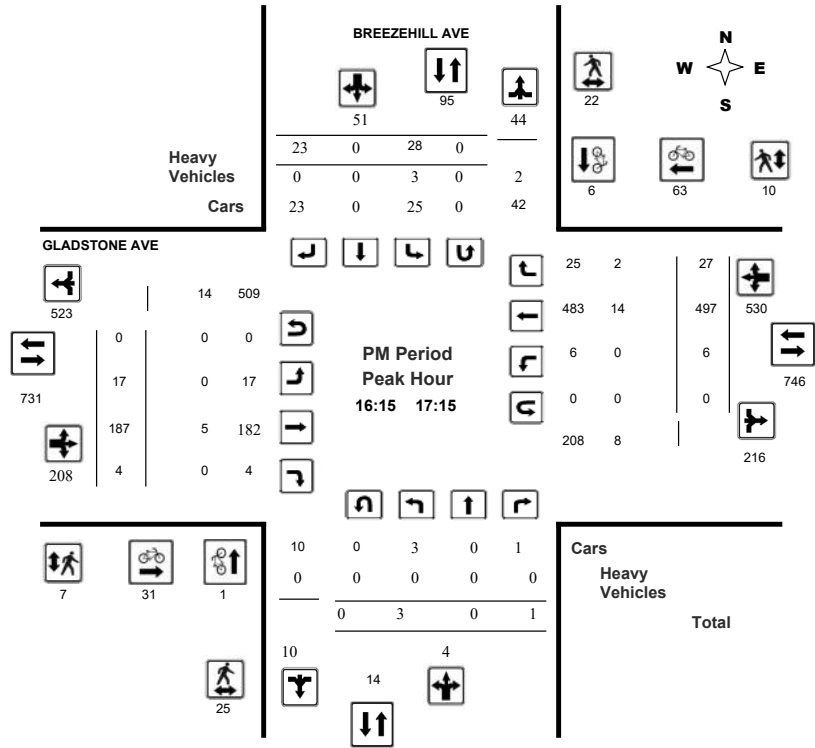

Transportation Services - Traffic Services

Work Order
37971

Turning Movement Count - 15 Min U-Turn Total Report
BREEZEHILL AVE @ GLADSTONE AVE

Survey Date: Wednesday, July 18, 2018

Time Period	Northbound U-Turn Total	Southbound U-Turn Total	Eastbound U-Turn Total	Westbound U-Turn Total	Total
07:00 07:15	0	0	0	0	0
07:15 07:30	0	0	0	0	0
07:30 07:45	0	0	0	0	0
07:45 08:00	0	0	0	0	0
08:00 08:15	0	0	0	0	0
08:15 08:30	0	0	0	0	0
08:30 08:45	0	0	0	0	0
08:45 09:00	0	0	0	0	0
09:00 09:15	0	0	0	0	0
09:15 09:30	0	0	0	0	0
09:30 09:45	0	0	0	0	0
09:45 10:00	0	0	0	0	0
11:30 11:45	0	0	0	0	0
11:45 12:00	0	0	0	0	0
12:00 12:15	0	0	0	0	0
12:15 12:30	0	0	0	0	0
12:30 12:45	0	0	0	0	0
12:45 13:00	0	0	0	0	0
13:00 13:15	0	0	0	0	0
13:15 13:30	0	0	0	0	0
15:00 15:15	0	0	0	0	0
15:15 15:30	0	0	0	0	0
15:30 15:45	0	0	0	0	0
15:45 16:00	0	0	0	0	0
16:00 16:15	0	0	0	0	0
16:15 16:30	0	0	0	0	0
16:30 16:45	0	0	0	0	0
16:45 17:00	0	0	0	0	0
17:00 17:15	0	0	0	0	0
17:15 17:30	0	0	0	0	0
17:30 17:45	0	0	0	0	0
17:45 18:00	0	0	0	0	0
Total	0	0	0	0	0



Turning Movement Count Summary, AM and PM Peak Hour Flow Diagrams

Automobiles, Taxis, Light Trucks, Vans, SUV's, Motorcycles, Heavy Trucks, Buses, and School Buses

Gladstone Avenue & Loretta Avenue North Ottawa, ON

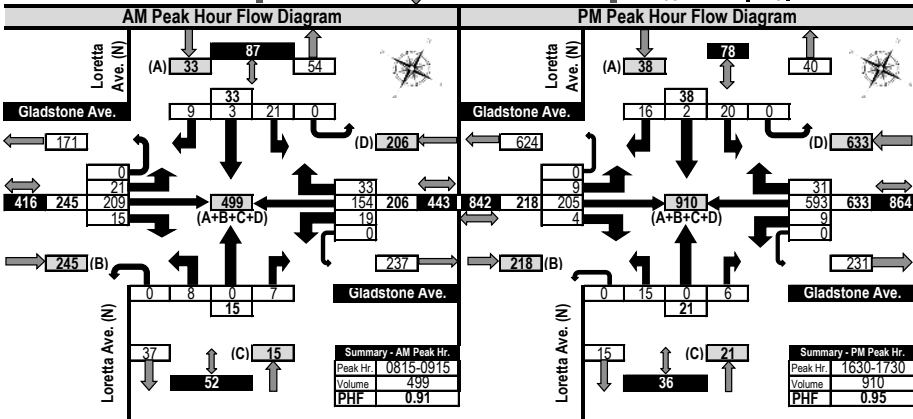
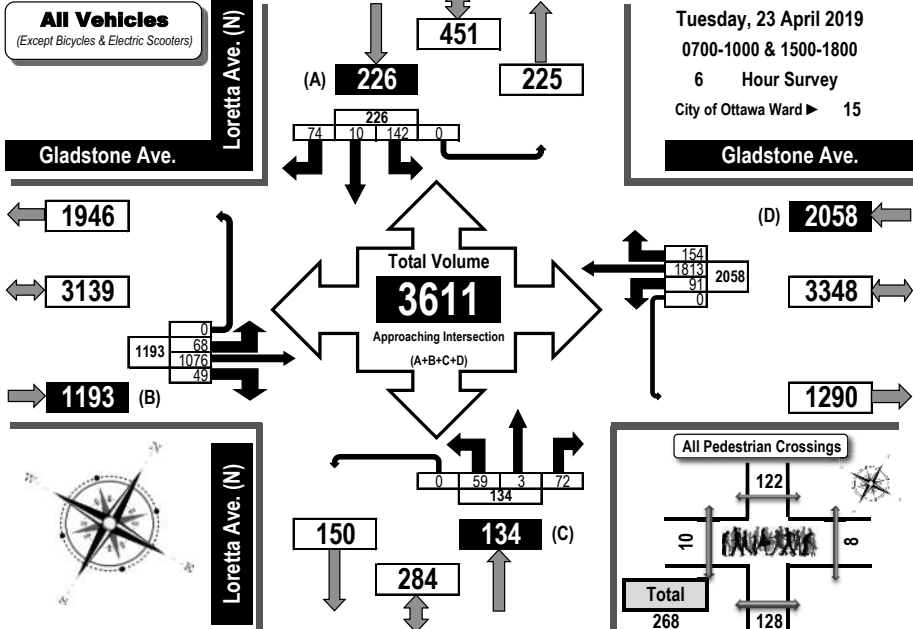

Turning Movement Count Summary Report AADT and Expansion Factors

Automobiles, Taxis, Light Trucks, Vans, SUV's, Motorcycles, Heavy Trucks, Buses, and School Buses

Gladstone Avenue & Loretta Avenue North Ottawa, ON

Survey Date: Tuesday, 23 April 2019 Start Time: 0700 AADT Factor: 0.7
Weather AM: Partly Cloudy +10°C Survey Duration: 6 Hrs. Survey Hours: 0700-1000 & 1500-1800
Weather PM: Overcast +17°C Surveyor(s): Carmody

Time Period	Gladstone Ave. Eastbound				Gladstone Ave. Westbound				Loretta Ave. (N) Northbound				Loretta Ave. (N) Southbound				Street Total	Grand Total					
	LT	ST	RT	UT	LT	ST	RT	UT	LT	ST	RT	UT	LT	ST	RT	UT							
0700-0800	6	142	18	0	166	22	112	24	0	158	324	1	0	6	0	7	13	3	4	0	20	27	351
0800-0900	17	214	9	0	240	19	140	35	0	194	434	8	0	10	0	18	20	2	3	0	25	43	477
0900-1000	16	168	11	0	195	24	160	27	0	211	406	2	0	7	0	9	14	2	11	0	27	36	442
1500-1600	10	174	5	0	189	13	358	22	0	393	582	26	1	35	0	62	39	1	24	0	64	126	708
1600-1700	9	188	2	0	199	4	525	18	0	547	746	11	1	10	0	22	37	1	20	0	58	80	826
1700-1800	10	190	4	0	204	9	518	28	0	555	759	11	1	4	0	16	19	1	12	0	32	48	807
Totals	68	1076	49	0	1193	91	1813	154	0	2058	3251	59	3	72	0	134	142	10	74	0	226	360	3611

Equivalent 12 & 24-hour Vehicle Volumes Including the Annual Average Daily Traffic (AADT) Factor
Applicable to the Day and Month of the Turning Movement Count

Expansion factors are applied exclusively to standard weekday 8-hour turning movement counts conducted during the hours of 0700h - 1000h, 1130h - 1330h and 1500h - 1800h

Equ. 12 Hr	LT	ST	RT	UT	TOT	S.TOT	LT	ST	RT	UT	TOT	S.TOT	LT	ST	RT	UT	TOT	S.TOT	G.TOT					
Equivalent 12-hour vehicle volumes. These volumes are calculated by multiplying the 8-hour totals by the 8 → 12 expansion factor of 1.39	n/a	n/a	n/a	n/a	n/a	n/a	n/a	n/a	n/a	n/a	n/a	n/a	n/a	n/a	n/a	n/a	n/a	n/a	n/a	n/a	n/a	n/a	n/a	
Average daily 12-hour vehicle volumes. These volumes are calculated by multiplying the equivalent 12-hour totals by the AADT factor of: 0.7	n/a	n/a	n/a	n/a	n/a	n/a	n/a	n/a	n/a	n/a	n/a	n/a	n/a	n/a	n/a	n/a	n/a	n/a	n/a	n/a	n/a	n/a	n/a	n/a
24-Hour AADT. These volumes are calculated by multiplying the average daily 12-hour vehicle volumes by the 12 → 24 expansion factor of 1.31	n/a	n/a	n/a	n/a	n/a	n/a	n/a	n/a	n/a	n/a	n/a	n/a	n/a	n/a	n/a	n/a	n/a	n/a	n/a	n/a	n/a	n/a	n/a	n/a

AADT and expansion factors provided by the City of Ottawa

AM Peak Hour Factor	Highest Hourly Vehicle Volume Between 0700h & 1000h																						
AM Peak Hr	LT	ST	RT	UT	TOT	LT	ST	RT	UT	TOT	S.TOT	LT	ST	RT	UT	TOT	LT	ST	RT	UT	TOT	S.TOT	G.TOT
0815-0915	21	209	15	0	245	19	154	33	0	206	451	8	0	7	0	15	21	3	9	0	33	48	499

PM Peak Hour Factor	Highest Hourly Vehicle Volume Between 1500h & 1800h																						
PM Peak Hr	LT	ST	RT	UT	TOT	LT	ST	RT	UT	TOT	S.TOT	LT	ST	RT	UT	TOT	LT	ST	RT	UT	TOT	S.TOT	G.TOT
1630-1730	9	205	4	0	218	9	593	31	0	633	851	15	0	6	0	21	20	2	16	0	38	59	910

Comments:

No traffic issues noted during survey.

Notes:

- Includes all vehicle types except bicycles, electric bicycles, and electric scooters.
- When expansion and AADT factors are applied, the results will differ slightly due to rounding.



Turning Movement Count Pedestrian Crossings Summary and Flow Diagram



Gladstone Avenue & Loretta Avenue North Ottawa, ON

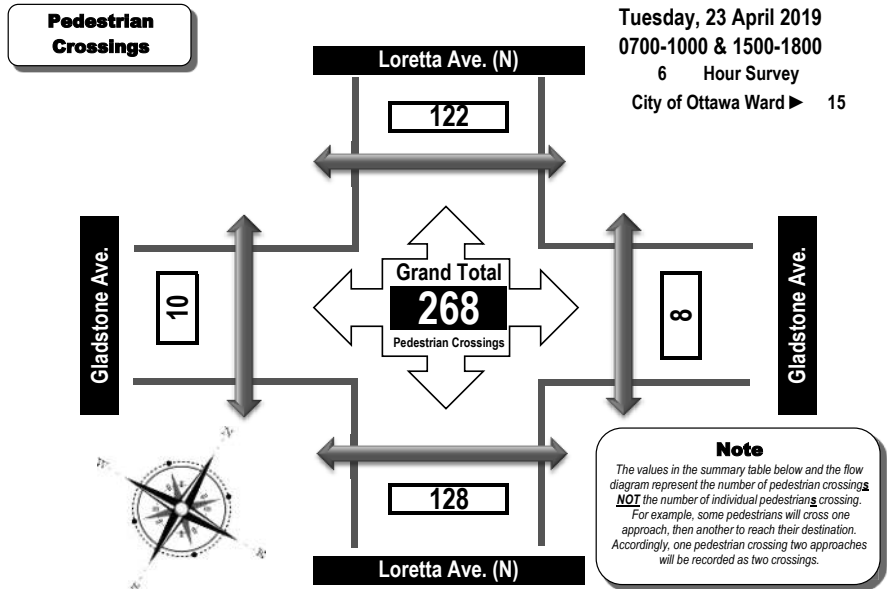

Time Period	West Side Crossing Gladstone Ave.	East Side Crossing Gladstone Ave.	Street Total	South Side Crossing Loretta Ave. (N)	North Side Crossing Loretta Ave. (N)	Street Total	Grand Total
0700-0800	6	2	8	13	15	28	36
0800-0900	2	2	4	14	16	30	34
0900-1000	0	0	0	16	17	33	33
1500-1600	0	1	1	24	23	47	48
1600-1700	0	0	0	27	28	55	55
1700-1800	2	3	5	34	23	57	62
Totals	10	8	18	128	122	250	268

Comments:
No traffic issues noted during survey.



Turning Movement Count Bicycle Summary Flow Diagram



Gladstone Avenue & Loretta Avenue North Ottawa, ON

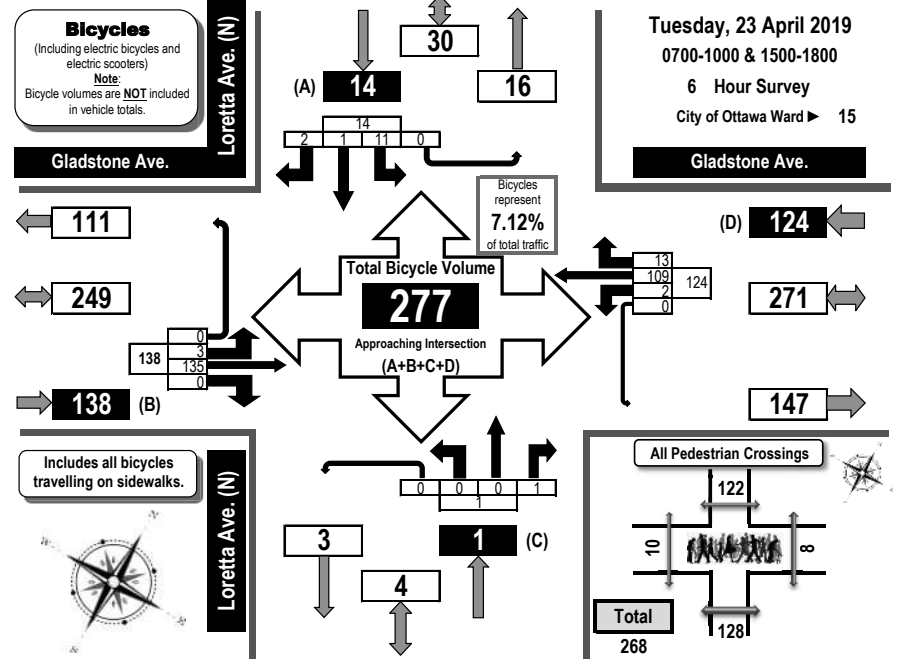

Time Period	Gladstone Ave. Eastbound				Gladstone Ave. Westbound				Loretta Ave. (N) Northbound				Loretta Ave. (N) Southbound				G.Tot.			
	LT	ST	RT	UT	LT	ST	RT	UT	LT	ST	RT	UT	LT	ST	RT	UT				
0700-0800	0	26	0	0	26	0	9	1	0	10	0	0	0	0	1	1	0	0	2	38
0800-0900	1	55	0	0	56	1	15	2	0	18	0	1	0	1	7	0	0	0	7	82
0900-1000	0	15	0	0	15	0	8	0	0	8	0	0	0	0	1	0	0	0	1	24
1500-1600	1	10	0	0	11	0	14	1	0	15	0	0	0	0	1	0	1	0	2	28
1600-1700	1	17	0	0	18	1	29	2	0	32	0	0	0	0	1	0	0	0	1	51
1700-1800	0	12	0	0	12	0	34	7	0	41	0	0	0	0	0	1	0	1	1	54
Totals	3	135	0	0	138	2	109	13	0	124	0	1	0	1	11	1	2	14	277	

Comments:
No traffic issues noted during survey.



Turning Movement Count Heavy Vehicle Summary Flow Diagram

Heavy Trucks, Buses,
and School Buses

Gladstone Avenue & Loretta Avenue North Ottawa, ON

Heavy Vehicles
(Construction Vehicles, Heavy Trucks, Buses & School Buses).
Heavy vehicle totals ARE included in the all vehicles summary and flow diagrams.

Gladstone Ave.

Loretta Ave. (N)

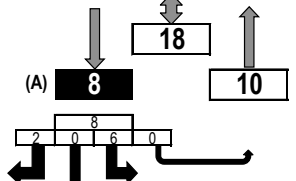

Tuesday, 23 April 2019
0700-1000 & 1500-1800
6 Hour Survey
City of Ottawa Ward ► 15

Gladstone Ave.

60

112

52 (B)



Loretta Ave. (N)

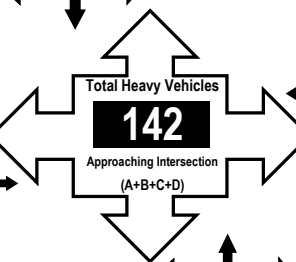

(D) 73

131

58

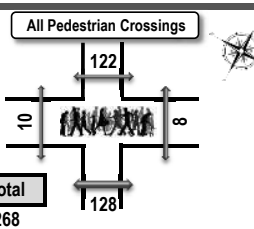

	Gladstone Ave. Eastbound				Gladstone Ave. Westbound				Loretta Ave. (N) Northbound				Loretta Ave. (N) Southbound			
Time Period	LT	ST	RT	UT	LT	ST	RT	UT	LT	ST	RT	UT	LT	ST	RT	UT

Time Period	LT	ST	RT	UT	S. Tot	LT	ST	RT	UT	S. Tot	LT	ST	RT	UT	S. Tot	LT	ST	RT	UT	S. Tot	G.Tot.
0700-0800	0	6	2	0	8	1	7	1	0	9	0	0	1	0	1	0	0	0	0	0	18
0800-0900	0	8	1	0	9	0	10	3	0	13	0	0	4	0	4	2	0	0	0	2	28
0900-1000	1	14	1	0	16	2	15	3	0	20	0	0	0	0	0	1	0	2	0	3	39
1500-1600	0	6	1	0	7	3	7	1	0	11	0	0	2	0	2	1	0	0	0	1	21
1600-1700	0	5	1	0	6	1	10	0	0	11	2	0	0	0	2	1	0	0	0	1	20
1700-1800	0	6	0	0	6	1	7	1	0	9	0	0	0	0	0	1	0	0	0	1	16
Totals	1	45	6	0	52	8	56	9	0	73	2	0	7	0	9	6	0	2	0	8	142

Comments:
No traffic issues noted during survey.



Transportation Services - Traffic Services w.o. 37132 Turning Movement Count - 15 Minute Summary Report

GLADSTONE AVE @ PRESTON ST

Survey Date: Tuesday, June 20, 2017
Total Observed U-Turns
Northbound: 0 Southbound: 0
Eastbound: 1 Westbound: 0

Time Period	PRESTON ST Northbound				PRESTON ST Southbound				PRESTON ST Eastbound				PRESTON ST Westbound				Grand Total		
	LT	ST	RT	TOT	LT	ST	RT	TOT	LT	ST	RT	TOT	LT	ST	RT	TOT			
07:00-07:15	12	66	16	94	12	82	2	96	190	4	25	10	39	10	27	19	56	95	285
07:15-07:30	3	78	19	100	14	104	3	121	221	2	24	8	34	10	23	12	45	79	300
07:30-07:45	13	85	15	113	10	70	4	84	197	3	29	13	45	8	25	12	45	90	287
07:45-08:00	13	95	15	123	17	90	7	114	237	11	32	10	53	13	24	14	51	104	341
08:00-08:15	12	99	17	128	19	85	3	107	235	7	39	16	62	13	28	21	62	124	359
08:15-08:30	14	100	27	141	18	91	10	119	260	9	56	19	84	17	40	17	74	158	418
08:30-08:45	9	120	21	150	20	91	3	114	264	5	52	14	71	6	49	14	69	140	404
08:45-09:00	10	94	16	120	16	78	0	94	214	10	50	13	73	12	41	16	69	142	356
09:00-09:15	13	81	20	114	21	108	10	139	253	5	27	13	45	12	35	17	64	109	362
09:15-09:30	19	61	18	98	23	94	8	125	223	8	27	12	47	12	40	21	73	120	343
09:30-09:45	14	79	17	110	24	84	11	119	229	9	25	10	45	21	26	15	62	107	336
09:45-10:00	9	73	19	101	16	75	3	94	195	4	30	11	45	11	38	17	66	111	306
11:30-11:45	8	70	20	98	20	63	4	87	185	5	24	14	43	29	22	20	71	114	299
11:45-12:00	9	67	23	99	15	89	13	117	216	2	38	12	52	27	53	27	107	159	375
12:00-12:15	13	79	21	113	11	84	11	106	219	5	35	13	53	30	41	28	99	152	371
12:15-12:30	11	89	25	125	16	67	5	88	213	5	35	14	54	22	44	29	95	149	362
12:30-12:45	7	53	19	79	18	97	11	126	205	6	33	13	52	21	34	27	82	134	339
12:45-13:00	16	63	27	106	21	77	4	102	208	8	32	19	59	22	44	25	91	150	358
13:00-13:15	13	89	19	121	14	83	9	106	227	9	40	19	68	24	44	21	89	157	384
13:15-13:30	12	73	22	107	29	75	8	112	219	10	35	11	56	21	41	21	83	139	358
15:00-15:15	15	84	29	128	8	95	8	111	239	5	39	26	70	24	62	27	113	183	422
15:15-15:30	21	118	24	163	17	97	9	123	286	6	40	11	57	16	64	15	95	152	438
15:30-15:45	12	98	16	126	13	73	10	96	222	5	39	14	58	26	92	20	138	196	418
15:45-16:00	13	108	16	137	12	86	6	104	241	10	48	14	72	19	96	15	130	202	443
16:00-16:15	27	118	19	164	15	83	9	107	271	4	40	8	52	22	97	14	133	185	456
16:15-16:30	14	104	22	140	12	95	10	117	257	3	48	11	62	18	107	20	145	207	464
16:30-16:45	16	83	29	128	9	86	8	103	231	6	51	13	70	24	101	20	145	215	446
16:45-17:00	22	92	23	137	15	103	10	128	265	3	43	6	52	18	114	24	156	208	473
17:00-17:15	24	95	27	146	16	80	21	117	263	8	45	8	61	20	117	13	150	211	474
17:15-17:30	12	79	24	115	7	85	8	100	215	1	40	9	50	24	100	20	144	194	409
17:30-17:45	13	86	31	130	15	71	7	93	223	8	48	8	64	26	85	25	136	200	423
17:45-18:00	13	84	12	109	6	94	11	111	220	8	45	12	65	27	78	20	125	190	410
TOTAL:	432	2763	668	3863	499	2735	246	3480	7343	194	1214	404	1813	605	1832	626	3063	4876	12219

Note: U-Turns are included in Totals. Comment:



Transportation Services - Traffic Services
Turning Movement Count - Cyclist Volume Report

Work Order
37132

GLADSTONE AVE @ PRESTON ST

Count Date: Tuesday, June 20, 2017

Start Time: 07:00

Time Period	PRESTON ST			GLADSTONE AVE			Grand Total
	Northbound	Southbound	Street Total	Eastbound	Westbound	Street Total	
07:00 08:00	0	8	8	19	14	33	41
08:00 09:00	10	14	24	47	25	72	96
09:00 10:00	7	8	15	15	21	36	51
11:30 12:30	5	9	14	10	8	18	32
12:30 13:30	8	10	18	4	14	18	36
15:00 16:00	8	8	16	17	15	32	48
16:00 17:00	11	13	24	20	42	62	86
17:00 18:00	7	8	15	27	38	65	80
Total	56	78	134	159	177	336	470

Comment:

Note: These volumes consists of bicycles only (no mopeds or motorcycles) and ARE NOT included in the Turning Movement Count Summary.



Transportation Services - Traffic Services
Turning Movement Count - Full Study Diagram

GLADSTONE AVE @ PRESTON ST

Survey Date: Tuesday, June 20, 2017

WO#: 37132
Device: Miovision

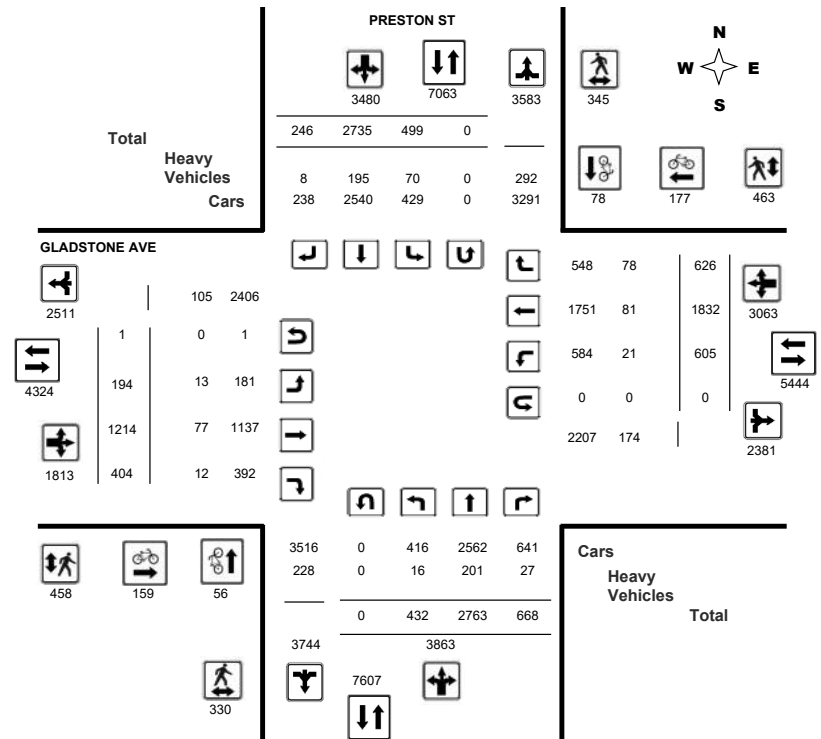

Comments



Transportation Services - Traffic Services

W.O.
37132

Turning Movement Count - Heavy Vehicle Report

GLADSTONE AVE @ PRESTON ST

Survey Date: Tuesday, June 20, 2017

PRESTON ST										GLADSTONE AVE										W TOT	STR TOT	Grand Total
Northbound					Southbound					Eastbound					Westbound							
Time Period	LT	ST	RT	N TOT	LT	ST	RT	S TOT	STR TOT	LT	ST	RT	E TOT	LT	ST	RT	W TOT	STR TOT				
07:00 08:00	1	26	5	32	13	22	1	36	68	2	12	1	15	0	9	5	14	29	97			
08:00 09:00	1	28	5	34	11	26	0	37	71	4	10	3	17	4	12	10	26	43	114			
09:00 10:00	4	33	5	42	12	40	0	52	94	2	12	4	18	3	13	12	28	46	140			
11:30 12:30	1	25	2	28	6	29	4	39	67	1	9	1	11	3	9	14	26	37	104			
12:30 13:30	5	27	2	34	15	22	0	37	71	1	10	2	13	7	11	11	29	42	113			
15:00 16:00	3	27	4	34	3	24	3	30	64	3	6	1	10	3	12	8	23	33	97			
16:00 17:00	1	21	3	25	7	18	0	25	50	0	11	0	11	0	9	11	20	31	81			
17:00 18:00	0	14	1	15	3	14	0	17	32	0	7	0	7	1	6	7	14	21	53			
Sub Total	16	201	27	244	70	195	8	273	517	13	77	12	102	21	81	78	180	282	799			
U-Turns (Heavy Vehicles)	0	0	0	0	0	0	0	0	0	0	0	0	0	0	0	0	0	0	0			
Total	16	201	27	244	70	195	8	273	517	13	77	12	102	21	81	78	180	282	799			

Heavy Vehicles include Buses, Single-Unit Trucks and Articulated Trucks. Further, they ARE included in the Turning Movement Count Summary.



Transportation Services - Traffic Services

Work Order
37132

Turning Movement Count - Pedestrian Volume Report

GLADSTONE AVE @ PRESTON ST

Count Date: Tuesday, June 20, 2017

Start Time: 07:00

Time Period	NB Approach (E or W Crossing)	SB Approach (E or W Crossing)	Total	EB Approach (N or S Crossing)	WB Approach (N or S Crossing)	Total	Grand Total
07:00 07:15	1	3	4	1	3	4	8
07:15 07:30	7	5	12	3	4	7	19
07:30 07:45	7	10	17	8	12	20	37
07:45 08:00	19	6	25	12	14	26	51
07:00 08:00	34	24	58	24	33	57	115
08:00 08:15	10	7	17	9	16	25	42
08:15 08:30	8	9	17	4	15	19	36
08:30 08:45	26	22	48	21	40	61	109
08:45 09:00	13	16	29	10	23	33	62
08:00 09:00	57	54	111	44	94	138	249
09:00 09:15	12	6	18	3	9	12	30
09:15 09:30	8	6	14	5	14	19	33
09:30 09:45	4	9	13	9	3	12	25
09:45 10:00	9	10	19	10	12	22	41
09:00 10:00	33	31	64	27	38	65	129
11:30 11:45	9	4	13	8	14	22	35
11:45 12:00	8	9	17	11	9	20	37
12:00 12:15	14	13	27	18	13	31	58
12:15 12:30	14	9	23	27	8	35	58
11:30 12:30	45	35	80	64	44	108	188
12:30 12:45	10	9	19	16	20	36	55
12:45 13:00	8	8	16	13	16	29	45
13:00 13:15	6	11	17	20	14	34	51
13:15 13:30	4	6	10	12	12	24	34
12:30 13:30	28	34	62	61	62	123	185
15:00 15:15	6	7	13	16	14	30	43
15:15 15:30	9	11	20	10	19	29	49
15:30 15:45	10	5	15	17	11	28	43
15:45 16:00	21	11	32	11	13	24	56
15:00 16:00	46	34	80	54	57	111	191
16:00 16:15	8	14	22	22	14	36	58
16:15 16:30	10	15	25	20	16	36	61
16:30 16:45	10	16	26	33	22	55	81
16:45 17:00	16	12	28	28	12	40	68
16:00 17:00	44	57	101	103	64	167	268
17:00 17:15	15	16	31	23	18	41	72
17:15 17:30	13	17	30	18	22	40	70
17:30 17:45	9	18	27	13	8	21	48
17:45 18:00	6	25	31	27	23	50	81
17:00 18:00	43	76	119	81	71	152	271
Total	330	345	675	458	463	921	1596

Comment:



Transportation Services - Traffic Services

Work Order
37132

Turning Movement Count - Full Study Summary Report

GLADSTONE AVE @ PRESTON ST

Survey Date: Tuesday, June 20, 2017

Total Observed U-Turns		AADT Factor .90
Northbound: 0	Southbound: 0	
Eastbound: 1	Westbound: 0	
Grand Total: 1		

Full Study

Period	PRESTON ST								GLADSTONE AVE								WB TOT	STR TOT	Grand Total			
	Northbound				Southbound				Eastbound				Westbound									
	LT	ST	RT	NB TOT	LT	ST	RT	SB TOT	STR TOT	LT	ST	RT	EB TOT	LT	ST	RT				WB TOT		
07:00 08:00	41	324	65	430	53	346	16	415	845	20	110	41	171	41	99	57	197	368	1213			
08:00 09:00	45	413	81	539	73	345	16	434	973	31	197	62	290	48	158	68	274	564	1537			
09:00 10:00	55	294	74	423	84	361	32	477	900	26	109	46	181	56	139	70	265	446	1346			
11:30 12:30	41	305	89	435	62	303	33	398	833	17	132	53	202	108	160	104	372	574	1407			
12:30 13:30	48	278	87	413	82	332	32	446	859	33	140	62	235	88	163	94	345	580	1439			
15:00 16:00	61	408	85	554	50	351	33	434	988	26	166	65	257	85	314	77	476	733	1721			
16:00 17:00	79	397	93	569	51	367	37	455	1024	16	182	38	236	82	419	78	579	815	1839			
17:00 18:00	62	344	94	500	44	330	47	421	921	25	178	37	240	97	380	78	555	795	1716			
Sub Total	432	2763	668	3863	499	2735	246	3480	7343	194	1214	404	1812	605	1832	626	3063	4875	12218			
U Turns	0				0				0				1				0				1	1
Total	432	2763	668	3863	499	2735	246	3480	7343	194	1214	404	1813	605	1832	626	3063	4876	12219			

EQ 12Hr 600 3841 929 5370 694 3802 342 4837 10207 270 1687 562 2520 841 2546 870 4258 6778 16985

Note: These values are calculated by multiplying the totals by the appropriate expansion factor. 1.39

AVG 12Hr 540 3457 836 4833 624 3421 308 4353 9186 243 1519 505 2268 757 2292 783 3832 6100 15286

Note: These volumes are calculated by multiplying the Equivalent 12 hr. totals by the AADT factor. .90

AVG 24Hr 708 4528 1095 6331 818 4482 403 5703 12034 318 1990 662 2971 991 3002 1026 5020 7991 20025

Note: These volumes are calculated by multiplying the Average Daily 12 hr. totals by 12 to 24 expansion factor. 1.31

Comments:

Note: U-Turns provided for approach totals. Refer to 'U-Turn' Report for specific breakdown.



Transportation Services - Traffic Services

Turning Movement Count - Peak Hour Diagram

GLADSTONE AVE @ PRESTON ST

Survey Date: Tuesday, June 20, 2017

WO No: 37132

Start Time: 07:00

Device: Miovision

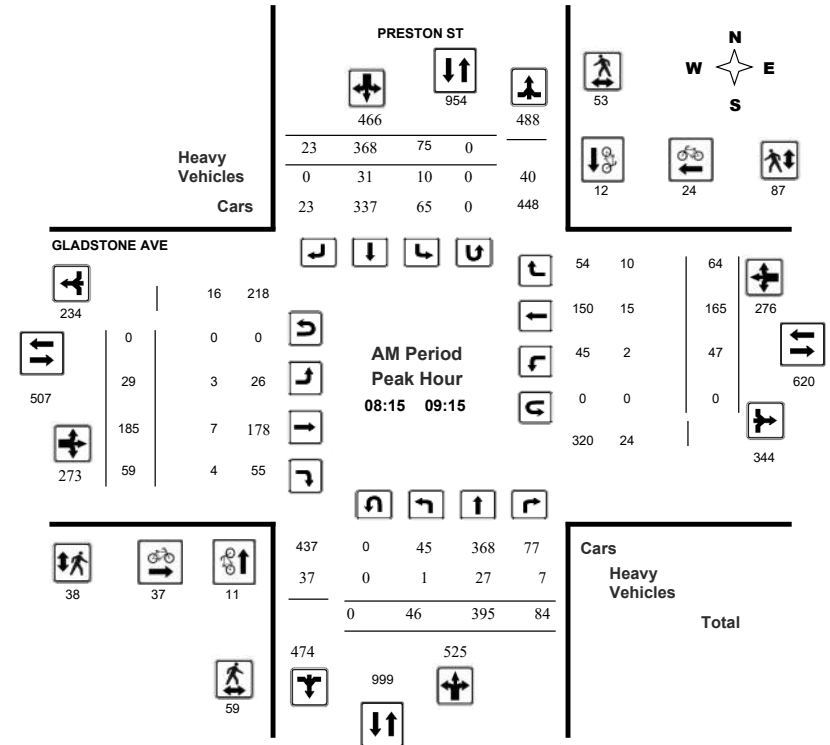



Transportation Services - Traffic Services

Turning Movement Count - Peak Hour Diagram

GLADSTONE AVE @ PRESTON ST

Survey Date: Tuesday, June 20, 2017
Start Time: 07:00

WO No: 37132
Device: Miovision

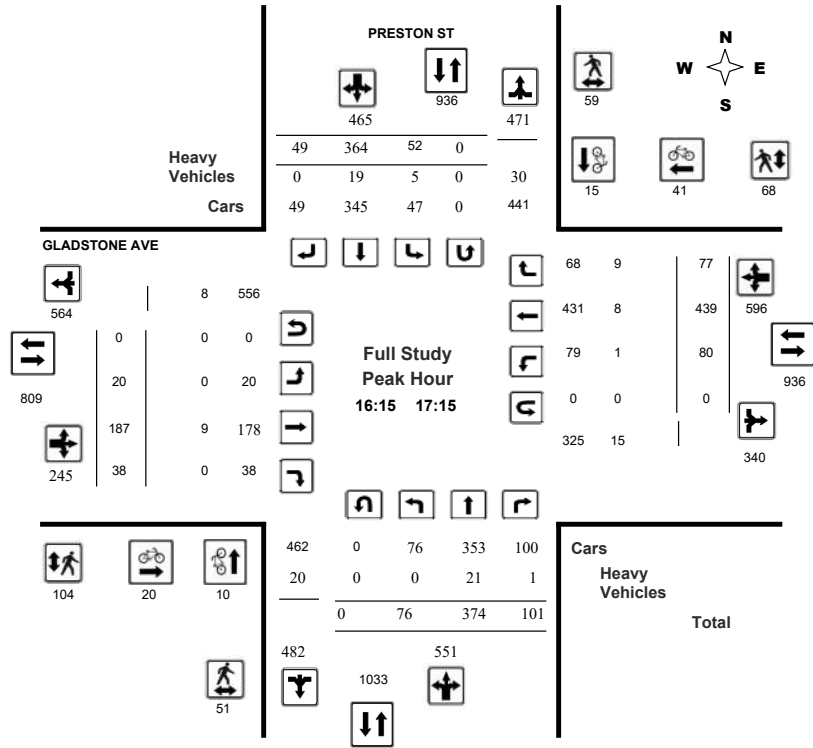

Transportation Services - Traffic Services

Turning Movement Count - Peak Hour Diagram

GLADSTONE AVE @ PRESTON ST

Survey Date: Tuesday, June 20, 2017
Start Time: 07:00

WO No: 37132
Device: Miovision

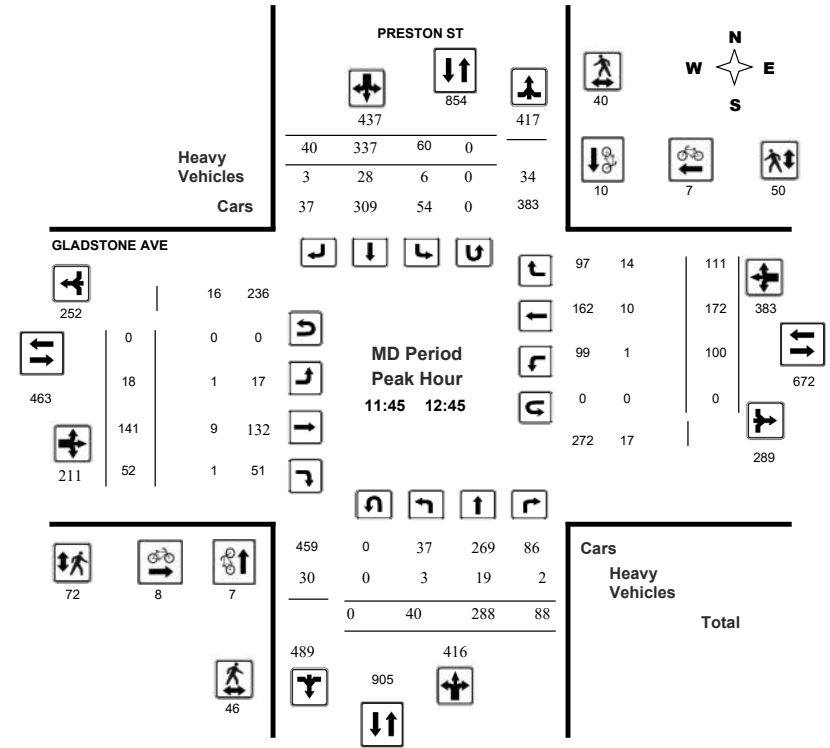



Transportation Services - Traffic Services
Turning Movement Count - Peak Hour Diagram
GLADSTONE AVE @ PRESTON ST

Survey Date: Tuesday, June 20, 2017
 Start Time: 07:00

WO No: 37132
 Device: Miovision

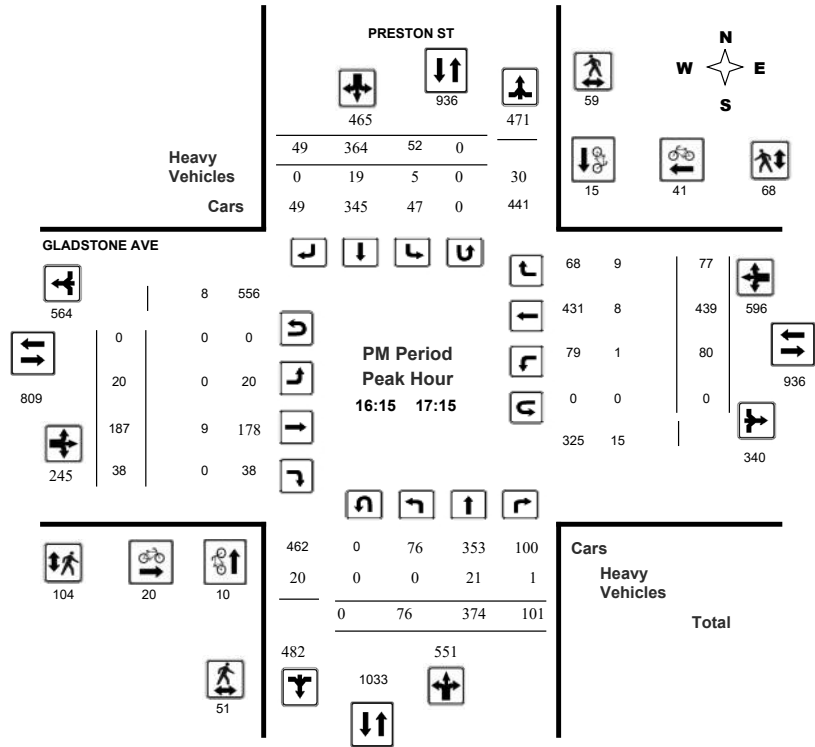

Transportation Services - Traffic Services

Work Order
37132

Turning Movement Count - 15 Min U-Turn Total Report
GLADSTONE AVE @ PRESTON ST

Survey Date: Tuesday, June 20, 2017

Time Period	Northbound U-Turn Total	Southbound U-Turn Total	Eastbound U-Turn Total	Westbound U-Turn Total	Total
07:00 07:15	0	0	0	0	0
07:15 07:30	0	0	0	0	0
07:30 07:45	0	0	0	0	0
07:45 08:00	0	0	0	0	0
08:00 08:15	0	0	0	0	0
08:15 08:30	0	0	0	0	0
08:30 08:45	0	0	0	0	0
08:45 09:00	0	0	0	0	0
09:00 09:15	0	0	0	0	0
09:15 09:30	0	0	0	0	0
09:30 09:45	0	0	1	0	1
09:45 10:00	0	0	0	0	0
11:30 11:45	0	0	0	0	0
11:45 12:00	0	0	0	0	0
12:00 12:15	0	0	0	0	0
12:15 12:30	0	0	0	0	0
12:30 12:45	0	0	0	0	0
12:45 13:00	0	0	0	0	0
13:00 13:15	0	0	0	0	0
13:15 13:30	0	0	0	0	0
15:00 15:15	0	0	0	0	0
15:15 15:30	0	0	0	0	0
15:30 15:45	0	0	0	0	0
15:45 16:00	0	0	0	0	0
16:00 16:15	0	0	0	0	0
16:15 16:30	0	0	0	0	0
16:30 16:45	0	0	0	0	0
16:45 17:00	0	0	0	0	0
17:00 17:15	0	0	0	0	0
17:15 17:30	0	0	0	0	0
17:30 17:45	0	0	0	0	0
17:45 18:00	0	0	0	0	0
Total	0	0	1	0	1



Turning Movement Count Summary, AM and PM Peak Hour Flow Diagrams

Automobiles, Taxis, Light Trucks, Vans, SUV's, Motorcycles, Heavy Trucks, Buses, and School Buses

Breezhill Avenue & Laurel Street Ottawa, ON

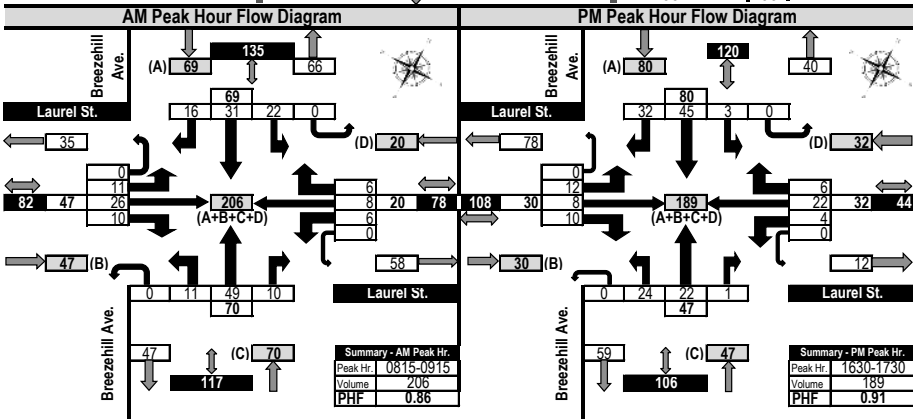
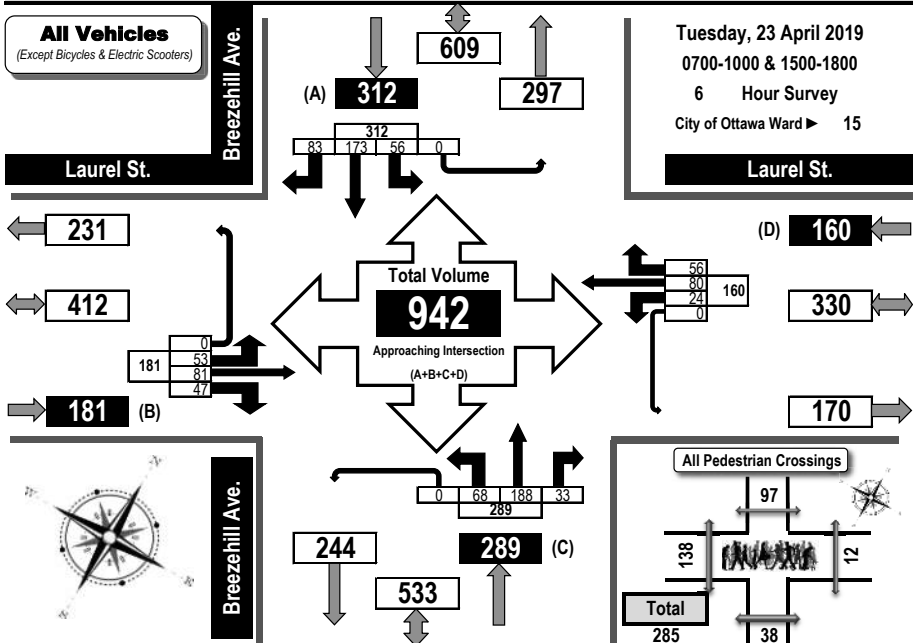

Turning Movement Count Summary Report AADT and Expansion Factors

Automobiles, Taxis, Light Trucks, Vans, SUV's, Motorcycles, Heavy Trucks, Buses, and School Buses

Breezhill Avenue & Laurel Street Ottawa, ON

Survey Date: Tuesday, 23 April 2019
Weather AM: Partly Cloudy +10°C
Weather PM: Overcast +17°C
Start Time: 0700
Survey Duration: 6 Hrs.
Survey Hours: 0700-1000 & 1500-1800
Surveyor(s): Carmody
AADT Factor: 0.7

Time Period	Laurel St. Eastbound					Laurel St. Westbound					Breezhill Ave. Northbound					Breezhill Ave. Southbound					Grand Total		
	LT	ST	RT	UT	TOT	LT	ST	RT	UT	TOT	LT	ST	RT	UT	TOT	LT	ST	RT	UT	TOT			
0700-0800	4	16	4	0	24	2	5	7	0	14	38	7	26	7	0	40	10	17	2	0	29	69	107
0800-0900	12	19	5	0	36	6	8	11	0	25	61	12	44	9	0	65	15	36	18	0	69	134	195
0900-1000	12	19	11	0	42	4	11	10	0	25	67	4	39	8	0	51	14	21	9	0	44	95	162
1500-1600	4	9	12	0	25	6	19	16	0	41	66	14	29	6	0	49	8	29	8	0	45	94	160
1600-1700	12	11	10	0	33	4	19	7	0	30	63	9	27	0	0	36	6	33	18	0	57	93	156
1700-1800	9	7	5	0	21	2	18	5	0	25	46	22	23	3	0	48	3	37	28	0	68	116	162
Totals	53	81	47	0	181	24	80	56	0	160	341	68	188	33	0	289	56	173	83	0	312	601	942

Equivalent 12 & 24-hour Vehicle Volumes Including the Annual Average Daily Traffic (AADT) Factor
Applicable to the Day and Month of the Turning Movement Count

Expansion factors are applied exclusively to standard weekday 8-hour turning movement counts conducted during the hours of 0700h - 1000h, 1130h - 1330h and 1500h - 1800h

Equ. 12 Hr	LT	ST	RT	UT	TOT	LT	ST	RT	UT	TOT	LT	ST	RT	UT	TOT	LT	ST	RT	UT	TOT	LT	ST	RT	UT	TOT	LT	ST	RT	UT	TOT	LT	ST	RT	UT	TOT	LT	ST	RT	UT	TOT
Equ. 12 Hr	n/a	n/a	n/a	n/a	n/a	n/a	n/a	n/a	n/a	n/a	n/a	n/a	n/a	n/a	n/a	n/a	n/a	n/a	n/a	n/a	n/a	n/a	n/a	n/a	n/a	n/a	n/a	n/a	n/a	n/a	n/a	n/a	n/a	n/a	n/a	n/a	n/a	n/a	n/a	n/a
AADT 12-hr	n/a	n/a	n/a	n/a	n/a	n/a	n/a	n/a	n/a	n/a	n/a	n/a	n/a	n/a	n/a	n/a	n/a	n/a	n/a	n/a	n/a	n/a	n/a	n/a	n/a	n/a	n/a	n/a	n/a	n/a	n/a	n/a	n/a	n/a	n/a	n/a	n/a	n/a	n/a	n/a
AADT 24 Hr	n/a	n/a	n/a	n/a	n/a	n/a	n/a	n/a	n/a	n/a	n/a	n/a	n/a	n/a	n/a	n/a	n/a	n/a	n/a	n/a	n/a	n/a	n/a	n/a	n/a	n/a	n/a	n/a	n/a	n/a	n/a	n/a	n/a	n/a	n/a	n/a	n/a	n/a	n/a	n/a

AADT and expansion factors provided by the City of Ottawa

AM Peak Hr	LT	ST	RT	UT	TOT	LT	ST	RT	UT	TOT	LT	ST	RT	UT	TOT	LT	ST	RT	UT	TOT	LT	ST	RT	UT	TOT	LT	ST	RT	UT	TOT	LT	ST	RT	UT	TOT	LT	ST	RT	UT	TOT					
AM Peak Hr	LT	ST	RT	UT	TOT	LT	ST	RT	UT	TOT	LT	ST	RT	UT	TOT	LT	ST	RT	UT	TOT	LT	ST	RT	UT	TOT	LT	ST	RT	UT	TOT	LT	ST	RT	UT	TOT	LT	ST	RT	UT	TOT	LT	ST	RT	UT	TOT
0815-0915	11	26	10	0	47	6	8	6	0	20	67	11	49	10	0	70	22	31	16	0	69	139	206																						

PM Peak Hr	LT	ST	RT	UT	TOT	LT	ST	RT	UT	TOT	LT	ST	RT	UT	TOT	LT	ST	RT	UT	TOT	LT	ST	RT	UT	TOT	LT	ST	RT	UT	TOT	LT	ST	RT	UT	TOT	LT	ST	RT	UT	TOT					
PM Peak Hr	LT	ST	RT	UT	TOT	LT	ST	RT	UT	TOT	LT	ST	RT	UT	TOT	LT	ST	RT	UT	TOT	LT	ST	RT	UT	TOT	LT	ST	RT	UT	TOT	LT	ST	RT	UT	TOT	LT	ST	RT	UT	TOT	LT	ST	RT	UT	TOT
1630-1730	12	8	10	0	30	4	22	6	0	32	62	24	22	1	0	47	3	45	32	0	80	127	189																						

Comments:

A cedar hedge growing along the property frontage on the southwest quadrant is creating a serious sightline problem. The majority of the cyclists as well as some drivers ignore the all-way stop control. Vehicles parked too close to the intersection on both Laurel Street, east of Breezhill Avenue and Breezhill Avenue, south of Laurel Street create a sightline problem.

Notes:

1. Includes all vehicle types except bicycles, electric bicycles, and electric scooters.
2. When expansion and AADT factors are applied, the results will differ slightly due to rounding.



Turning Movement Count Pedestrian Crossings Summary and Flow Diagram



Breezhill Avenue & Laurel Street Ottawa, ON

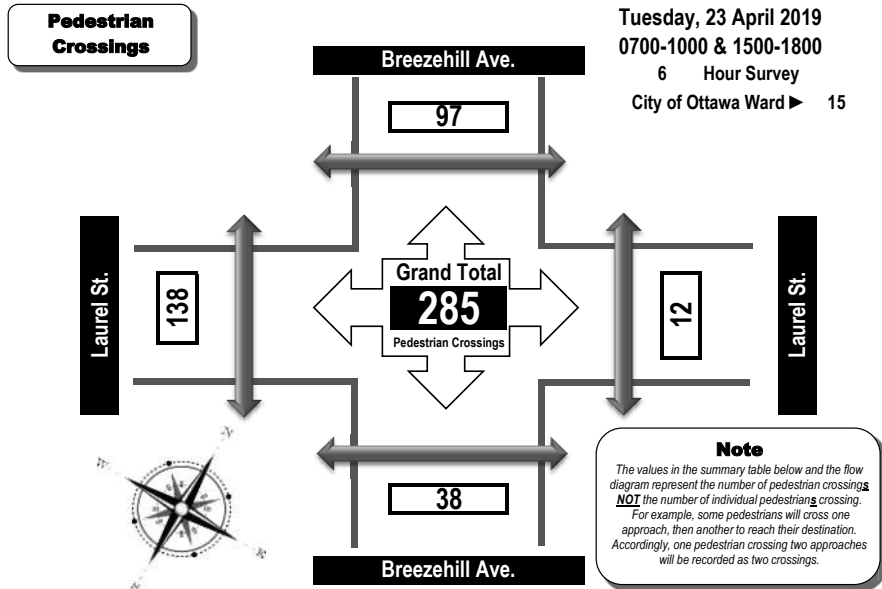

Time Period	West Side Crossing		East Side Crossing		Street Total	South Side Crossing		North Side Crossing		Street Total	Grand Total
	Laurel St.	Laurel St.	Laurel St.	Breezhill Ave.		Breezhill Ave.	Breezhill Ave.	Breezhill Ave.			
0700-0800	5	1	6	3	11	17					
0800-0900	54	4	58	14	32	90					
0900-1000	2	0	2	0	4	6					
1500-1600	50	0	50	12	35	85					
1600-1700	12	1	13	2	24	37					
1700-1800	15	6	21	7	29	50					
Totals	138	12	150	38	135	285					

Comments:

A cedar hedge growing along the property frontage on the southwest quadrant is creating a serious sightline problem. The majority of the cyclists as well as some drivers ignore the all-way stop control. Vehicles parked too close to the intersection on both Laurel Street, east of Breezhill Avenue and Breezhill Avenue, south of Laurel Street create a sightline problem.



Turning Movement Count Bicycle Summary Flow Diagram



Breezhill Avenue & Laurel Street Ottawa, ON

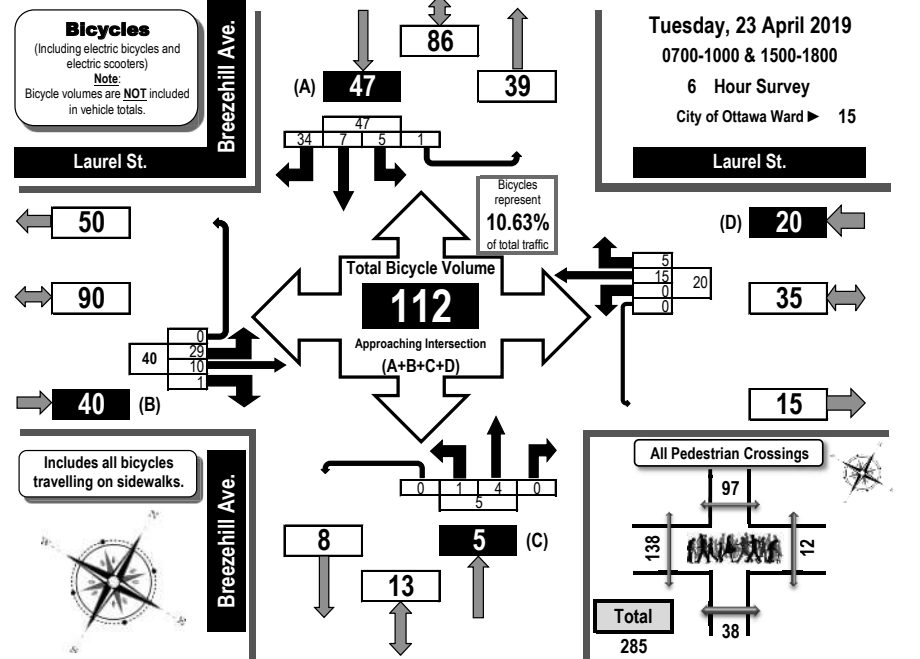

Time Period	Laurel St. Eastbound				Laurel St. Westbound				Breezhill Ave. Northbound				Breezhill Ave. Southbound				S. Tot	G. Tot	
	LT	ST	RT	UT	LT	ST	RT	UT	LT	ST	RT	UT	LT	ST	RT	UT			
0700-0800	6	1	0	0	7	0	0	0	0	1	2	0	0	3	0	0	0	0	10
0800-0900	15	6	1	0	22	0	2	1	0	3	0	1	0	1	1	0	0	1	28
0900-1000	4	1	0	0	5	0	2	0	0	2	0	0	0	0	2	0	0	0	9
1500-1600	3	2	0	0	5	0	3	2	0	5	0	0	0	0	2	1	11	0	24
1600-1700	1	0	0	0	1	0	4	1	0	5	0	1	0	1	0	2	14	0	23
1700-1800	0	0	0	0	0	0	4	1	0	5	0	0	0	0	0	4	9	0	13
Totals	29	10	1	0	40	0	15	5	0	20	1	4	0	5	5	7	34	1	112

Comments:

A cedar hedge growing along the property frontage on the southwest quadrant is creating a serious sightline problem. The majority of the cyclists as well as some drivers ignore the all-way stop control. Vehicles parked too close to the intersection on both Laurel Street, east of Breezhill Avenue and Breezhill Avenue, south of Laurel Street create a sightline problem.



Turning Movement Count Heavy Vehicle Summary Flow Diagram

Heavy Trucks, Buses,
and School Buses

Breezhill Avenue & Laurel Street Ottawa, ON

Heavy Vehicles
(Construction Vehicles, Heavy Trucks, Buses & School Buses).
Heavy vehicle totals **ARE** included in the all vehicles summary and flow diagrams.

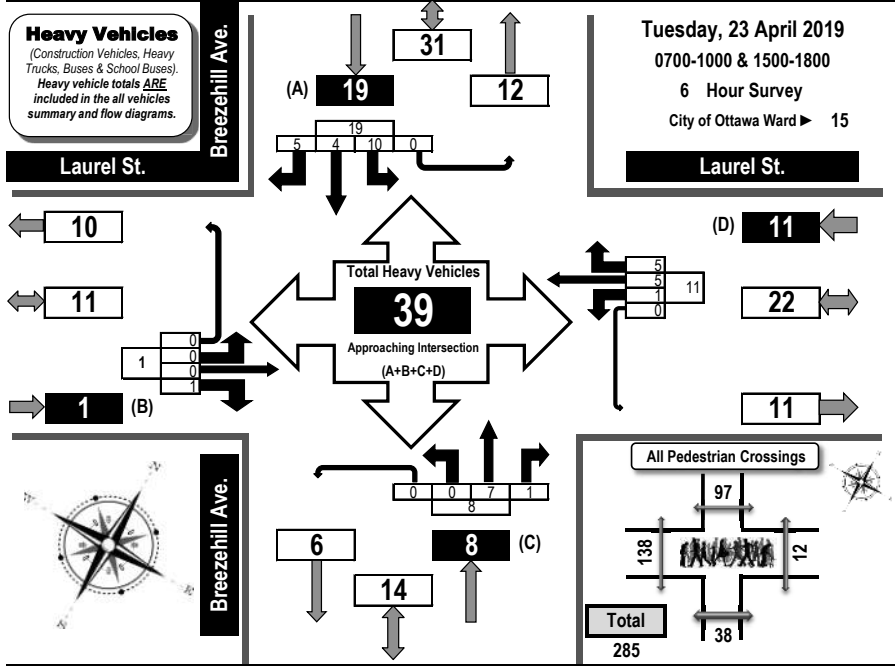

Time Period	Laurel St. Eastbound				Laurel St. Westbound				Breezhill Ave. Northbound				Breezhill Ave. Southbound				S. Tot	G.Tot.	
	LT	ST	RT	UT	LT	ST	RT	UT	LT	ST	RT	UT	LT	ST	RT	UT			
0700-0800	0	0	0	0	0	0	1	0	1	0	1	0	1	2	0	0	1	2	4
0800-0900	0	0	0	0	0	0	0	3	3	0	0	1	1	3	0	3	6	10	
0900-1000	0	0	1	0	1	1	2	1	4	0	4	0	4	2	2	1	5	14	
1500-1600	0	0	0	0	0	0	1	0	1	0	1	0	1	1	0	1	2	4	
1600-1700	0	0	0	0	0	0	1	0	1	0	0	0	0	1	1	0	2	3	
1700-1800	0	0	0	0	0	0	0	1	1	0	1	0	1	1	1	0	2	4	
Totals	0	0	1	0	1	1	5	5	11	0	7	1	8	10	4	5	19	39	

Comments:
A cedar hedge growing along the property frontage on the southwest quadrant is creating a serious sightline problem. The majority of the cyclists as well as some drivers ignore the all-way stop control. Vehicles parked too close to the intersection on both Laurel Street, east of Breezhill Avenue and Breezhill Avenue, south of Laurel Street create a sightline problem.



Transportation Services - Traffic Services W.O. 35301

Turning Movement Count - 15 Minute Summary Report

BREEZHILL AVE @ SOMERSET ST

Survey Date: Thursday, August 13, 2015 Total Observed U-Turns
Northbound: 0 Southbound: 0
Eastbound: 4 Westbound: 2

Time Period	BREEZHILL AVE Northbound				BREEZHILL AVE Southbound				SOMERSET ST Eastbound				SOMERSET ST Westbound				Grand Total		
	LT	ST	RT	N TOT	LT	ST	RT	S TOT	STR TOT	LT	ST	RT	E TOT	LT	ST	RT		W TOT	
07:00-07:15	2	0	2	4	0	0	0	0	4	0	27	5	32	3	21	0	24	56	60
07:15-07:30	0	0	6	6	0	0	0	0	6	0	29	3	32	2	35	0	37	69	75
07:30-07:45	2	0	3	5	0	0	0	0	5	0	53	2	55	1	35	0	36	91	96
07:45-08:00	2	0	4	6	0	0	0	0	6	0	62	3	65	4	54	0	58	123	129
08:00-08:15	3	0	6	9	0	0	0	0	9	0	65	5	70	4	56	0	60	130	139
08:15-08:30	4	0	5	9	0	0	0	0	9	0	92	3	95	4	42	0	46	141	150
08:30-08:45	3	0	4	7	0	0	0	0	7	0	54	5	59	3	40	0	43	102	109
08:45-09:00	3	0	9	12	0	0	0	0	12	0	64	4	68	4	50	0	54	122	134
09:00-09:15	3	0	6	9	0	0	0	0	9	0	63	8	71	5	68	0	73	144	153
09:15-09:30	5	0	4	9	0	0	0	0	9	0	62	4	66	5	53	0	58	124	133
09:30-09:45	6	0	7	13	0	0	0	0	13	0	76	3	79	2	66	0	68	147	160
09:45-10:00	2	0	5	7	0	0	0	0	7	0	59	10	70	2	67	0	69	139	146
11:30-11:45	5	0	2	7	0	0	0	0	7	0	81	2	83	3	74	0	77	160	167
11:45-12:00	9	0	3	12	0	0	0	0	12	0	81	3	84	5	69	0	74	158	170
12:00-12:15	7	0	12	19	0	0	0	0	19	0	78	8	86	12	80	0	92	178	197
12:15-12:30	4	0	8	12	0	0	0	0	12	0	69	4	74	5	70	0	75	149	161
12:30-12:45	6	0	3	9	0	0	0	0	9	0	71	5	76	2	64	0	66	142	151
12:45-13:00	1	0	4	5	0	0	0	0	5	0	80	9	89	5	72	0	77	166	171
13:00-13:15	4	0	3	7	0	0	0	0	7	0	65	7	72	2	66	0	68	140	147
13:15-13:30	5	0	5	10	0	0	0	0	10	0	49	5	54	6	86	0	92	146	156
15:00-15:15	6	0	2	8	0	0	0	0	8	0	65	5	70	2	74	0	76	146	154
15:15-15:30	7	0	6	13	0	0	0	0	13	0	66	2	68	5	89	0	94	162	175
15:30-15:45	8	0	8	16	0	0	0	0	16	0	58	4	62	3	93	0	96	158	174
15:45-16:00	4	0	2	6	0	0	0	0	6	0	61	4	66	6	75	0	81	147	153
16:00-16:15	2	0	7	9	0	0	0	0	9	0	73	3	76	5	96	0	101	177	186
16:15-16:30	3	0	5	8	0	0	0	0	8	0	87	7	94	7	108	0	115	209	217
16:30-16:45	5	0	3	8	0	0	0	0	8	0	65	8	73	4	104	0	109	182	190
16:45-17:00	3	0	4	7	0	0	0	0	7	0	86	3	89	6	114	0	120	209	216
17:00-17:15	8	0	3	11	0	0	0	0	11	0	78	5	83	2	92	0	94	177	188
17:15-17:30	4	0	3	7	0	0	0	0	7	0	78	3	81	7	113	0	121	202	209
17:30-17:45	4	0	5	9	0	0	0	0	9	0	64	3	68	7	110	0	117	185	194
17:45-18:00	2	0	6	8	0	0	0	0	8	0	76	2	78	3	93	0	96	174	182
TOTAL:	132	0	155	287	0	0	0	0	287	0	2137	147	2288	136	2329	0	2467	4755	5042

Note: U-Turns are included in Totals.

Comment:



Transportation Services - Traffic Services
Turning Movement Count - Cyclist Volume Report

Work Order
 35301

BREEZEHILL AVE @ SOMERSET ST

Count Date: Thursday, August 13, 2015

Start Time: 07:00

Time Period	BREEZEHILL AVE			SOMERSET ST			Grand Total
	Northbound	Southbound	Street Total	Eastbound	Westbound	Street Total	
07:00 08:00	6	0	6	38	24	62	68
08:00 09:00	17	0	17	99	39	138	155
09:00 10:00	6	0	6	33	28	61	67
11:30 12:30	4	0	4	28	25	53	57
12:30 13:30	2	0	2	21	30	51	53
15:00 16:00	3	0	3	41	34	75	78
16:00 17:00	3	0	3	50	79	129	132
17:00 18:00	4	0	4	59	101	160	164
Total	45	0	45	369	360	729	774

Comment:

Note: These volumes consists of bicycles only (no mopeds or motorcycles) and ARE NOT included in the Turning Movement Count Summary.



Transportation Services - Traffic Services
Turning Movement Count - Full Study Diagram

BREEZEHILL AVE @ SOMERSET ST

Survey Date: Thursday, August 13, 2015

WO#: 35301
 Device: Miovision

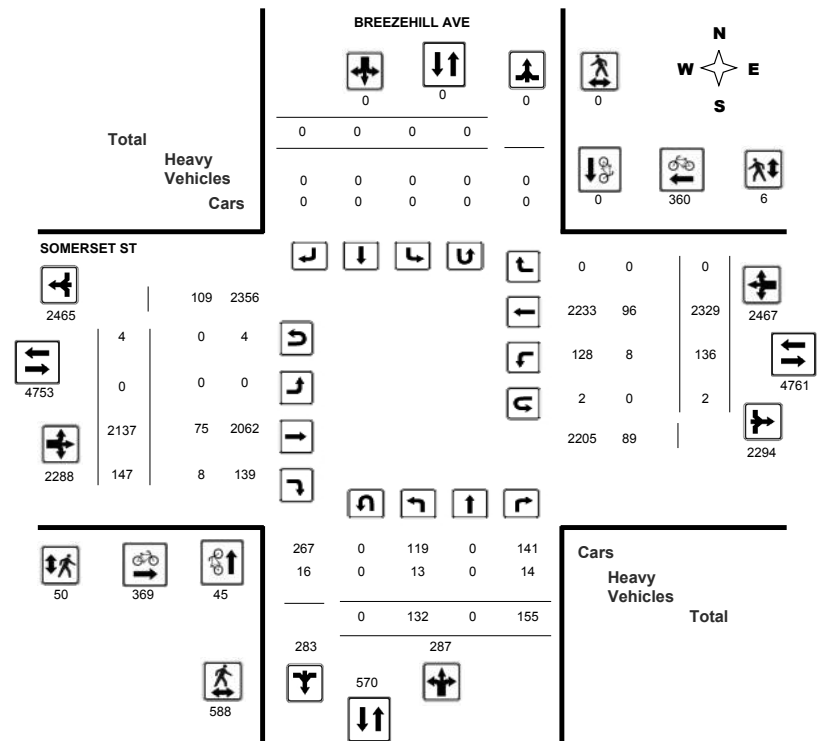

Comments



Transportation Services - Traffic Services

W.O. 35301

Turning Movement Count - Heavy Vehicle Report

BREEZEHILL AVE @ SOMERSET ST

Survey Date: Thursday, August 13, 2015

Table with columns for Time Period, Northbound (LT, ST, RT, N TOT), Southbound (LT, ST, RT, S TOT, STR TOT), Eastbound (LT, ST, RT, E TOT), Westbound (LT, ST, RT, W TOT, STR TOT), and Grand Total. Includes sub-totals for U-Turns and overall totals.

Heavy Vehicles include Buses, Single-Unit Trucks and Articulated Trucks. Further, they ARE included in the Turning Movement Count Summary.



Transportation Services - Traffic Services

Work Order 35301

Turning Movement Count - Pedestrian Volume Report

BREEZEHILL AVE @ SOMERSET ST

Count Date: Thursday, August 13, 2015

Start Time: 07:00

Table with columns for Time Period, NB Approach (E or W Crossing), SB Approach (E or W Crossing), Total, EB Approach (N or S Crossing), WB Approach (N or S Crossing), Total, and Grand Total. Lists pedestrian volume counts for various time intervals.

Comment:



Transportation Services - Traffic Services

Work Order
35301

Turning Movement Count - Full Study Summary Report

BREEZEHILL AVE @ SOMERSET ST

Survey Date: Thursday, August 13, 2015

Total Observed U-Turns		AADT Factor
Northbound: 0	Southbound: 0	
Eastbound: 4	Westbound: 2	
.90		

Full Study

Period	BREEZEHILL AVE									SOMERSET ST									Grand Total
	Northbound			Southbound			Eastbound			Westbound			STR TOT	WB TOT	STR TOT	WB TOT			
	LT	ST	RT	NB TOT	LT	ST	RT	SB TOT	STR TOT	LT	ST	RT					EB TOT	LT	
07:00 08:00	6	0	15	21	0	0	0	0	21	0	171	13	184	10	145	0	155	339	360
08:00 09:00	13	0	24	37	0	0	0	0	37	0	275	17	292	15	188	0	203	495	532
09:00 10:00	16	0	22	38	0	0	0	0	38	0	260	25	285	14	254	0	268	553	591
11:30 12:30	25	0	25	50	0	0	0	0	50	0	309	17	326	25	293	0	318	644	694
12:30 13:30	16	0	15	31	0	0	0	0	31	0	265	26	291	15	288	0	303	594	625
15:00 16:00	25	0	18	43	0	0	0	0	43	0	250	15	265	16	331	0	347	612	655
16:00 17:00	13	0	19	32	0	0	0	0	32	0	311	21	332	22	422	0	444	776	808
17:00 18:00	18	0	17	35	0	0	0	0	35	0	296	13	309	19	408	0	427	736	771
Sub Total	132	0	155	287	0	0	0	0	287	0	2137	147	2284	136	2329	0	2465	4749	5036
U Turns	0			0	0			0	4			2			6	6			
Total	132	0	155	287	0	0	0	0	287	0	2137	147	2288	136	2329	0	2467	4755	5042
EQ 12Hr	183	0	215	399	0	0	0	0	399	0	2970	204	3180	189	3237	0	3429	6609	7008
Note: These values are calculated by multiplying the totals by the appropriate expansion factor.													1.39						
AVG 12Hr	165	0	194	359	0	0	0	0	359	0	2673	184	2862	170	2914	0	3086	5948	6307
Note: These volumes are calculated by multiplying the Equivalent 12 hr. totals by the AADT factor.													.90						
AVG 24Hr	216	0	254	470	0	0	0	0	470	0	3502	241	3750	223	3817	0	4043	7793	8263
Note: These volumes are calculated by multiplying the Average Daily 12 hr. totals by 12 to 24 expansion factor.													1.31						

Comments:

Note: U-Turns provided for approach totals. Refer to 'U-Turn' Report for specific breakdown.



Transportation Services - Traffic Services

Turning Movement Count - Peak Hour Diagram

BREEZEHILL AVE @ SOMERSET ST

Survey Date: Thursday, August 13, 2015

Start Time: 07:00

WO No: 35301

Device: Miovision

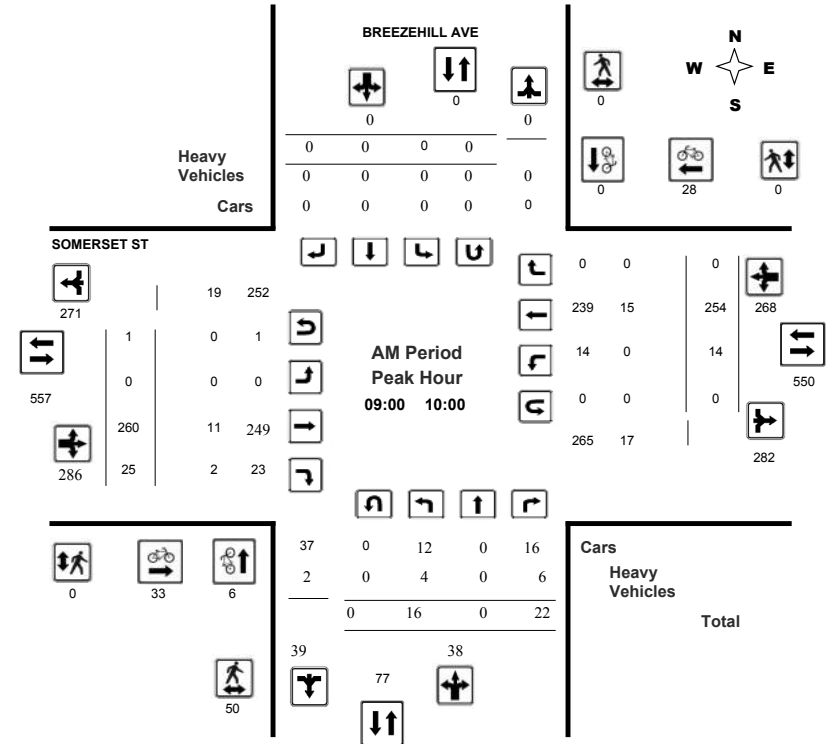

Comments



Transportation Services - Traffic Services

Turning Movement Count - Peak Hour Diagram

BREEZEHILL AVE @ SOMERSET ST

Survey Date: Thursday, August 13, 2015

Start Time: 07:00

WO No: 35301

Device: Miovision

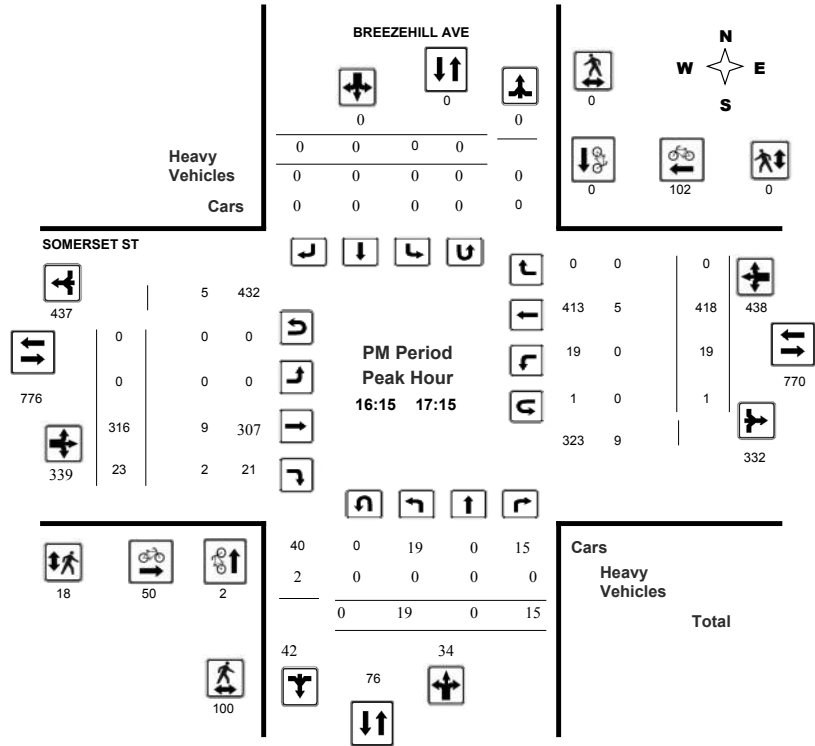

Comments



Transportation Services - Traffic Services

Work Order 35301

Turning Movement Count - 15 Min U-Turn Total Report

BREEZEHILL AVE @ SOMERSET ST

Survey Date: Thursday, August 13, 2015

Time Period	Northbound U-Turn Total	Southbound U-Turn Total	Eastbound U-Turn Total	Westbound U-Turn Total	Total
07:00 - 07:15	0	0	0	0	0
07:15 - 07:30	0	0	0	0	0
07:30 - 07:45	0	0	0	0	0
07:45 - 08:00	0	0	0	0	0
08:00 - 08:15	0	0	0	0	0
08:15 - 08:30	0	0	0	0	0
08:30 - 08:45	0	0	0	0	0
08:45 - 09:00	0	0	0	0	0
09:00 - 09:15	0	0	0	0	0
09:15 - 09:30	0	0	0	0	0
09:30 - 09:45	0	0	0	0	0
09:45 - 10:00	0	0	1	0	1
11:30 - 11:45	0	0	0	0	0
11:45 - 12:00	0	0	0	0	0
12:00 - 12:15	0	0	0	0	0
12:15 - 12:30	0	0	1	0	1
12:30 - 12:45	0	0	0	0	0
12:45 - 13:00	0	0	0	0	0
13:00 - 13:15	0	0	0	0	0
13:15 - 13:30	0	0	0	0	0
15:00 - 15:15	0	0	0	0	0
15:15 - 15:30	0	0	0	0	0
15:30 - 15:45	0	0	0	0	0
15:45 - 16:00	0	0	1	0	1
16:00 - 16:15	0	0	0	0	0
16:15 - 16:30	0	0	0	0	0
16:30 - 16:45	0	0	0	1	1
16:45 - 17:00	0	0	0	0	0
17:00 - 17:15	0	0	0	0	0
17:15 - 17:30	0	0	0	1	1
17:30 - 17:45	0	0	1	0	1
17:45 - 18:00	0	0	0	0	0
Total	0	0	4	2	6

Appendix C

Synchro Intersection Worksheets – Existing Conditions

HCM 2010 TWSC
1: Breezhill & Gladstone

951 Gladstone & 145 Loretta
Existing - AM Peak Hour

Intersection												
Int Delay, s/veh	1.5											
Movement	EBL	EBT	EBR	WBL	WBT	WBR	NBL	NBT	NBR	SBL	SBT	SBR
Lane Configurations	↔		↔		↔		↔		↔		↔	
Traffic Vol, veh/h	23	223	0	1	129	41	2	1	5	17	0	23
Future Vol, veh/h	23	223	0	1	129	41	2	1	5	17	0	23
Conflicting Peds, #/hr	21	0	25	25	0	21	8	0	2	2	0	8
Sign Control	Free	Free	Free	Free	Free	Free	Stop	Stop	Stop	Stop	Stop	Stop
RT Channelized	-	-	None	-	-	None	-	-	None	-	-	None
Storage Length	-	-	-	-	-	-	-	-	-	-	-	-
Veh in Median Storage, #	-	0	-	-	0	-	-	0	-	-	0	-
Grade, %	-	0	-	-	0	-	-	0	-	-	0	-
Peak Hour Factor	90	90	90	90	90	90	90	90	90	90	90	90
Heavy Vehicles, %	2	2	2	2	2	2	2	2	2	2	2	2
Mvmt Flow	26	248	0	1	143	46	2	1	6	19	0	26
Major/Minor	Major1		Major2		Minor1		Minor2					
Conflicting Flow All	210	0	0	273	0	0	514	537	275	495	514	195
Stage 1	-	-	-	-	-	-	325	325	-	189	189	-
Stage 2	-	-	-	-	-	-	189	212	-	306	325	-
Critical Hdwy	4.12	-	-	4.12	-	-	7.12	6.52	6.22	7.12	6.52	6.22
Critical Hdwy Stg 1	-	-	-	-	-	-	6.12	5.52	-	6.12	5.52	-
Critical Hdwy Stg 2	-	-	-	-	-	-	6.12	5.52	-	6.12	5.52	-
Follow-up Hdwy	2.218	-	-	2.218	-	-	3.518	4.018	3.318	3.518	4.018	3.318
Pot Cap-1 Maneuver	1361	-	-	1290	-	-	471	450	764	485	464	846
Stage 1	-	-	-	-	-	-	687	649	-	813	744	-
Stage 2	-	-	-	-	-	-	813	727	-	704	649	-
Platoon blocked, %	-	-	-	-	-	-	-	-	-	-	-	-
Mov Cap-1 Maneuver	1339	-	-	1265	-	-	437	424	748	463	437	827
Mov Cap-2 Maneuver	-	-	-	-	-	-	437	424	-	463	437	-
Stage 1	-	-	-	-	-	-	658	622	-	781	731	-
Stage 2	-	-	-	-	-	-	782	715	-	680	622	-
Approach	EB		WB		NB		SB					
HCM Control Delay, s	0.7		0		11.2		11.3					
HCM LOS	B		B		B		B					
Minor Lane/Major Mvmt	NBLn1	EBL	EBT	EBR	WBL	WBT	WBR	SBLn1				
Capacity (veh/h)	587	1339	-	-	1265	-	-	620				
HCM Lane V/C Ratio	0.015	0.019	-	-	0.001	-	-	0.072				
HCM Control Delay (s)	11.2	7.7	0	-	7.8	0	-	11.3				
HCM Lane LOS	B	A	A	-	A	A	-	B				
HCM 95th %tile Q(veh)	0	0.1	-	-	0	-	-	0.2				

Lanes, Volumes, Timings
2: Preston & Gladstone

951 Gladstone & 145 Loretta
Existing - AM Peak Hour

Lane Group	EBL	EBT	EBR	WBL	WBT	WBR	NBL	NBT	NBR	SBL	SBT	SBR
Lane Configurations		↔		↔	↔		↔	↔		↔	↔	
Traffic Volume (vph)	27	171	55	47	154	64	43	395	84	75	368	22
Future Volume (vph)	27	171	55	47	154	64	43	395	84	75	368	22
Satd. Flow (prot)	0	1616	0	1658	1588	0	1658	1643	0	1658	1722	0
Fit Permitted		0.936		0.487			0.465			0.389		
Satd. Flow (perm)	0	1507	0	791	1588	0	782	1643	0	635	1722	0
Satd. Flow (RTOR)					29			25				
Lane Group Flow (vph)	0	281	0	52	242	0	48	532	0	83	433	0
Turn Type	Perm	NA		Perm	NA		Perm	NA		Perm	NA	
Protected Phases		4			8			2			6	
Permitted Phases	4				8			2			6	
Detector Phase	4	4			8	8		2	2		6	6
Switch Phase												
Minimum Initial (s)	10.0	10.0			10.0	10.0		10.0	10.0		10.0	10.0
Minimum Split (s)	24.5	24.5			24.5	24.5		23.7	23.7		23.7	23.7
Total Split (s)	25.0	25.0			25.0	25.0		45.0	45.0		45.0	45.0
Total Split (%)	35.7%	35.7%			35.7%	35.7%		64.3%	64.3%		64.3%	64.3%
Yellow Time (s)	3.0	3.0			3.0	3.0		3.3	3.3		3.3	3.3
All-Red Time (s)	3.5	3.5			3.5	3.5		2.4	2.4		2.4	2.4
Lost Time Adjust (s)		0.0			0.0	0.0		0.0	0.0		0.0	0.0
Total Lost Time (s)		6.5			6.5	6.5		5.7	5.7		5.7	5.7
Lead/Lag												
Lead-Lag Optimize?												
Recall Mode	None	None			None	None		C-Min	C-Min		C-Min	C-Min
Act Effct Green (s)		17.3			17.3	17.3		40.5	40.5		40.5	40.5
Actuated g/C Ratio		0.25			0.25	0.25		0.58	0.58		0.58	0.58
v/c Ratio		0.76			0.27	0.59		0.11	0.55		0.23	0.43
Control Delay		37.8			23.8	25.9		8.5	12.2		10.3	10.7
Queue Delay		0.0			0.0	0.0		0.0	0.0		0.0	0.0
Total Delay		37.8			23.8	25.9		8.5	12.2		10.3	10.7
LOS		D			C	C		A	B		B	B
Approach Delay		37.8			25.5			11.9			10.7	
Approach LOS		D			C			B			B	
Queue Length 50th (m)		33.3			5.4	23.8		2.7	38.4		5.0	30.0
Queue Length 95th (m)		#57.3			13.6	43.1		7.6	68.1		12.8	52.0
Internal Link Dist (m)		300.5				149.8		122.5			139.6	
Turn Bay Length (m)					37.5			24.0			28.0	
Base Capacity (vph)		414			217	457		461	979		374	1015
Starvation Cap Reductn		0			0	0		0	0		0	0
Spillback Cap Reductn		0			0	0		0	0		0	0
Storage Cap Reductn		0			0	0		0	0		0	0
Reduced v/c Ratio		0.68			0.24	0.53		0.10	0.54		0.22	0.43
Intersection Summary												
Cycle Length: 70												
Actuated Cycle Length: 70												
Offset: 37 (53%), Referenced to phase 2:NBT and 6:SBTL, Start of Green												
Natural Cycle: 60												
Control Type: Actuated-Coordinated												

Lanes, Volumes, Timings
2: Preston & Gladstone

951 Gladstone & 145 Loretta
Existing - AM Peak Hour

Maximum v/c Ratio: 0.76	Intersection LOS: B
Intersection Signal Delay: 18.3	ICU Level of Service E
Intersection Capacity Utilization 86.4%	
Analysis Period (min) 15	
# 95th percentile volume exceeds capacity, queue may be longer.	
Queue shown is maximum after two cycles.	

Splits and Phases: 2: Preston & Gladstone



HCM 2010 TWSC
3: Breezehill & Somerset

951 Gladstone & 145 Loretta
Existing - AM Peak Hour

Intersection						
Int Delay, s/veh	1					
Movement	EBT	EBR	WBL	WBT	NBL	NBR
Lane Configurations	↔		↔		↔	
Traffic Vol, veh/h	260	25	14	254	16	22
Future Vol, veh/h	260	25	14	254	16	22
Conflicting Peds, #/hr	0	50	50	0	0	0
Sign Control	Free	Free	Free	Free	Stop	Stop
RT Channelized	-	None	-	None	-	None
Storage Length	-	-	-	-	0	-
Veh in Median Storage, #	0	-	-	0	0	-
Grade, %	0	-	-	0	0	-
Peak Hour Factor	90	90	90	90	90	90
Heavy Vehicles, %	2	2	2	2	2	2
Mvmt Flow	289	28	16	282	18	24

Major/Minor	Major1	Major2	Minor1
Conflicting Flow All	0	0	367
Stage 1	-	-	353
Stage 2	-	-	314
Critical Hdwy	-	4.12	6.42
Critical Hdwy Stg 1	-	-	5.42
Critical Hdwy Stg 2	-	-	5.42
Follow-up Hdwy	-	2.218	3.318
Pot Cap-1 Maneuver	-	1192	424
Stage 1	-	-	711
Stage 2	-	-	741
Platoon blocked, %	-	-	-
Mov Cap-1 Maneuver	-	1146	401
Mov Cap-2 Maneuver	-	-	401
Stage 1	-	-	683
Stage 2	-	-	728

Approach	EB	WB	NB
HCM Control Delay, s	0	0.4	12.5
HCM LOS			B

Minor Lane/Major Mvmt	NBLn1	EBT	EBR	WBL	WBT
Capacity (veh/h)	520	-	-	1146	-
HCM Lane V/C Ratio	0.081	-	-	0.014	-
HCM Control Delay (s)	12.5	-	-	8.2	0
HCM Lane LOS	B	-	-	A	A
HCM 95th %tile Q(veh)	0.3	-	-	0	-

HCM 2010 TWSC
6: Loretta & Gladstone

951 Gladstone & 145 Loretta
Existing - AM Peak Hour

Intersection												
Int Delay, s/veh	1.8											
Movement	EBL	EBT	EBR	WBL	WBT	WBR	NBL	NBT	NBR	SBL	SBT	SBR
Lane Configurations	↕			↕			↕			↕		
Traffic Vol, veh/h	21	209	15	19	154	33	8	0	7	21	3	9
Future Vol, veh/h	21	209	15	19	154	33	8	0	7	21	3	9
Conflicting Peds, #/hr	15	0	13	13	0	15	3	0	2	2	0	3
Sign Control	Free	Free	Free	Free	Free	Free	Stop	Stop	Stop	Stop	Stop	Stop
RT Channelized	-	-	None	-	-	None	-	-	None	-	-	None
Storage Length	-	-	-	-	-	-	-	-	-	-	-	-
Veh in Median Storage, #	-	0	-	-	0	-	-	0	-	-	0	-
Grade, %	-	0	-	-	0	-	-	0	-	-	0	-
Peak Hour Factor	90	90	90	90	90	90	90	90	90	90	90	90
Heavy Vehicles, %	2	2	2	2	2	2	2	2	2	2	2	2
Mvmt Flow	23	232	17	21	171	37	9	0	8	23	3	10
Major/Minor	Major1	Major2	Minor1	Minor2								
Conflicting Flow All	223	0	0	262	0	0	541	565	256	540	555	208
Stage 1	-	-	-	-	-	300	300	-	247	247	-	-
Stage 2	-	-	-	-	-	241	265	-	293	308	-	-
Critical Hdwy	4.12	-	-	4.12	-	7.12	6.52	6.22	7.12	6.52	6.22	-
Critical Hdwy Stg 1	-	-	-	-	-	6.12	5.52	-	6.12	5.52	-	-
Critical Hdwy Stg 2	-	-	-	-	-	6.12	5.52	-	6.12	5.52	-	-
Follow-up Hdwy	2.218	-	-	2.218	-	3.518	4.018	3.318	3.518	4.018	3.318	-
Pot Cap-1 Maneuver	1346	-	-	1302	-	452	434	783	453	440	832	-
Stage 1	-	-	-	-	-	709	666	-	757	702	-	-
Stage 2	-	-	-	-	-	762	689	-	715	660	-	-
Platoon blocked, %	-	-	-	-	-	-	-	-	-	-	-	-
Mov Cap-1 Maneuver	1330	-	-	1289	-	425	408	774	429	414	820	-
Mov Cap-2 Maneuver	-	-	-	-	-	425	408	-	429	414	-	-
Stage 1	-	-	-	-	-	688	646	-	734	680	-	-
Stage 2	-	-	-	-	-	733	668	-	693	640	-	-
Approach	EB	WB	NB	SB								
HCM Control Delay, s	0.7	0.7	11.9	12.9								
HCM LOS			B	B								
Minor Lane/Major Mvmt	NBLn1	EBL	EBT	EBR	WBL	WBT	WBR	SBLn1				
Capacity (veh/h)	538	1330	-	-	1289	-	-	491				
HCM Lane V/C Ratio	0.031	0.018	-	-	0.016	-	-	0.075				
HCM Control Delay (s)	11.9	7.8	0	-	7.8	0	-	12.9				
HCM Lane LOS	B	A	A	-	A	A	-	B				
HCM 95th %tile Q(veh)	0.1	0.1	-	-	0.1	-	-	0.2				

HCM 2010 AWSC
7: Breezehill & Laurel

951 Gladstone & 145 Loretta
Existing - AM Peak Hour

Intersection												
Intersection Delay, s/veh	7.5											
Intersection LOS	A											
Movement	EBL	EBT	EBR	WBL	WBT	WBR	NBL	NBT	NBR	SBL	SBT	SBR
Lane Configurations	↕			↕			↕			↕		
Traffic Vol, veh/h	11	26	10	6	8	6	11	49	10	22	31	16
Future Vol, veh/h	11	26	10	6	8	6	11	49	10	22	31	16
Peak Hour Factor	0.90	0.90	0.90	0.90	0.90	0.90	0.90	0.90	0.90	0.90	0.90	0.90
Heavy Vehicles, %	2	2	2	2	2	2	2	2	2	2	2	2
Mvmt Flow	12	29	11	7	9	7	12	54	11	24	34	18
Number of Lanes	0	1	0	0	1	0	0	1	0	0	1	0
Approach	EB	WB	NB	SB								
Opposing Approach	WB	EB	SB	NB								
Opposing Lanes	1	1	1	1								
Conflicting Approach Left	SB	NB	EB	WB								
Conflicting Lanes Left	1	1	1	1								
Conflicting Approach Right	NB	SB	WB	EB								
Conflicting Lanes Right	1	1	1	1								
HCM Control Delay	7.5	7.3	7.5	7.5								
HCM LOS	A	A	A	A								
Lane	NBLn1	EBLn1	WBLn1	SBLn1								
Vol Left, %	16%	23%	30%	32%								
Vol Thru, %	70%	55%	40%	45%								
Vol Right, %	14%	21%	30%	23%								
Sign Control	Stop	Stop	Stop	Stop								
Traffic Vol by Lane	70	47	20	69								
LT Vol	11	11	6	22								
Through Vol	49	26	8	31								
RT Vol	10	10	6	16								
Lane Flow Rate	78	52	22	77								
Geometry Grp	1	1	1	1								
Degree of Util (X)	0.088	0.06	0.025	0.086								
Departure Headway (Hd)	4.067	4.136	4.12	4.047								
Convergence, Y/N	Yes	Yes	Yes	Yes								
Cap	875	855	857	879								
Service Time	2.12	2.212	2.204	2.101								
HCM Lane V/C Ratio	0.089	0.061	0.026	0.088								
HCM Control Delay	7.5	7.5	7.3	7.5								
HCM Lane LOS	A	A	A	A								
HCM 95th %tile Q	0.3	0.2	0.1	0.3								

Lanes, Volumes, Timings
8: Bayswater & Gladstone

951 Gladstone & 145 Loretta
Existing - AM Peak Hour

Lane Group	EBL	EBT	EBR	WBL	WBT	WBR	NBL	NBT	NBR	SBL	SBT	SBR
Lane Configurations		↔			↔			↔			↔	
Traffic Volume (vph)	23	174	16	14	105	35	19	106	22	50	124	37
Future Volume (vph)	23	174	16	14	105	35	19	106	22	50	124	37
Satd. Flow (prot)	0	1706	0	0	1657	0	0	1688	0	0	1673	0
Fit Permitted		0.960			0.966			0.946			0.894	
Satd. Flow (perm)	0	1641	0	0	1606	0	0	1606	0	0	1510	0
Satd. Flow (RTOR)		9			32			16			20	
Lane Group Flow (vph)	0	237	0	0	172	0	0	163	0	0	235	0
Turn Type	Perm	NA		Perm	NA		Perm	NA		Perm	NA	
Protected Phases		2			6			8			4	
Permitted Phases	2			6			8			4		
Detector Phase	2	2		6	6		8	8		4	4	
Switch Phase												
Minimum Initial (s)	10.0	10.0		10.0	10.0		10.0	10.0		10.0	10.0	
Minimum Split (s)	22.5	22.5		22.5	22.5		22.5	22.5		22.5	22.5	
Total Split (s)	33.0	33.0		33.0	33.0		27.0	27.0		27.0	27.0	
Total Split (%)	55.0%	55.0%		55.0%	55.0%		45.0%	45.0%		45.0%	45.0%	
Yellow Time (s)	3.0	3.0		3.0	3.0		3.3	3.3		3.3	3.3	
All-Red Time (s)	2.5	2.5		2.5	2.5		2.0	2.0		2.0	2.0	
Lost Time Adjust (s)		0.0			0.0			0.0			0.0	
Total Lost Time (s)		5.5			5.5			5.3			5.3	
Lead/Lag												
Lead-Lag Optimize?												
Recall Mode	C-Max	C-Max		C-Max	C-Max		Max	Max		Max	Max	
Act Effct Green (s)		27.5			27.5			21.7			21.7	
Actuated g/C Ratio		0.46			0.46			0.36			0.36	
v/c Ratio		0.31			0.23			0.28			0.42	
Control Delay		11.3			8.9			13.8			16.0	
Queue Delay		0.0			0.0			0.0			0.0	
Total Delay		11.3			8.9			13.8			16.0	
LOS		B			A			B			B	
Approach Delay		11.3			8.9			13.8			16.0	
Approach LOS		B			A			B			B	
Queue Length 50th (m)		14.8			8.6			11.1			17.1	
Queue Length 95th (m)		27.8			18.4			22.9			33.3	
Internal Link Dist (m)		95.1			81.5			119.0			98.4	
Turn Bay Length (m)												
Base Capacity (vph)		757			753			591			558	
Starvation Cap Reductn		0			0			0			0	
Spillback Cap Reductn		0			0			0			0	
Storage Cap Reductn		0			0			0			0	
Reduced v/c Ratio		0.31			0.23			0.28			0.42	
Intersection Summary												
Cycle Length: 60												
Actuated Cycle Length: 60												
Offset: 29 (48%), Referenced to phase 2:EBTL and 6:WBTL, Start of Green												
Natural Cycle: 45												
Control Type: Actuated-Coordinated												

Lanes, Volumes, Timings
8: Bayswater & Gladstone

951 Gladstone & 145 Loretta
Existing - AM Peak Hour

Maximum v/c Ratio: 0.42	Intersection LOS: B
Intersection Signal Delay: 12.7	Intersection Capacity Utilization 46.5%
ICU Level of Service A	Analysis Period (min) 15

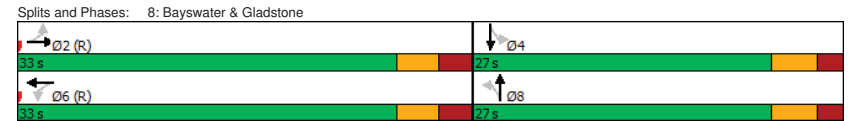

HCM 2010 TWSC
1: Breezhill & Gladstone

951 Gladstone & 145 Loretta
Existing - PM Peak Hour

Intersection												
Int Delay, s/veh	1.5											
Movement	EBL	EBT	EBR	WBL	WBT	WBR	NBL	NBT	NBR	SBL	SBT	SBR
Lane Configurations	↔		↔		↔		↔		↔		↔	
Traffic Vol, veh/h	17	189	4	6	591	27	3	0	1	28	0	23
Future Vol, veh/h	17	189	4	6	591	27	3	0	1	28	0	23
Conflicting Peds, #/hr	22	0	25	25	0	22	7	0	10	10	0	7
Sign Control	Free	Free	Free	Free	Free	Free	Stop	Stop	Stop	Stop	Stop	Stop
RT Channelized	-	-	None	-	-	None	-	-	None	-	-	None
Storage Length	-	-	-	-	-	-	-	-	-	-	-	-
Veh in Median Storage, #	-	0	-	-	0	-	-	0	-	-	0	-
Grade, %	-	0	-	-	0	-	-	0	-	-	0	-
Peak Hour Factor	90	90	90	90	90	90	90	90	90	90	90	90
Heavy Vehicles, %	2	2	2	2	2	2	2	2	2	2	2	2
Mvmt Flow	19	210	4	7	657	30	3	0	1	31	0	26
Major/Minor	Major1		Major2		Minor1		Minor2					
Conflicting Flow All	709	0	0	239	0	0	981	998	247	969	985	701
Stage 1	-	-	-	-	-	-	275	275	-	708	708	-
Stage 2	-	-	-	-	-	-	706	723	-	261	277	-
Critical Hdwy	4.12	-	-	4.12	-	-	7.12	6.52	6.22	7.12	6.52	6.22
Critical Hdwy Stg 1	-	-	-	-	-	-	6.12	5.52	-	6.12	5.52	-
Critical Hdwy Stg 2	-	-	-	-	-	-	6.12	5.52	-	6.12	5.52	-
Follow-up Hdwy	2.218	-	-	2.218	-	-	3.518	4.018	3.318	3.518	4.018	3.318
Pot Cap-1 Maneuver	890	-	-	1328	-	-	229	244	792	233	248	439
Stage 1	-	-	-	-	-	-	731	683	-	426	438	-
Stage 2	-	-	-	-	-	-	427	431	-	744	681	-
Platoon blocked, %	-	-	-	-	-	-	-	-	-	-	-	-
Mov Cap-1 Maneuver	875	-	-	1302	-	-	205	227	771	221	231	429
Mov Cap-2 Maneuver	-	-	-	-	-	-	205	227	-	221	231	-
Stage 1	-	-	-	-	-	-	699	653	-	408	427	-
Stage 2	-	-	-	-	-	-	396	420	-	719	651	-
Approach	EB		WB		NB		SB					
HCM Control Delay, s	0.7		0.1		19.6		20.9					
HCM LOS	C		C		C		C					
Minor Lane/Major Mvmt	NBLn1	EBL	EBT	EBR	WBL	WBT	WBR	SBLn1				
Capacity (veh/h)	251	875	-	-	1302	-	-	283				
HCM Lane V/C Ratio	0.018	0.022	-	-	0.005	-	-	0.2				
HCM Control Delay (s)	19.6	9.2	0	-	7.8	0	-	20.9				
HCM Lane LOS	C	A	A	-	A	A	-	C				
HCM 95th %tile Q(veh)	0.1	0.1	-	-	0	-	-	0.7				

Lanes, Volumes, Timings
2: Preston & Gladstone

951 Gladstone & 145 Loretta
Existing - PM Peak Hour



Lane Group	EBL	EBT	EBR	WBL	WBT	WBR	NBL	NBT	NBR	SBL	SBT	SBR
Lane Configurations		↔		↔	↔		↔	↔		↔	↔	
Traffic Volume (vph)	20	183	37	80	482	77	83	374	101	52	364	54
Future Volume (vph)	20	183	37	80	482	77	83	374	101	52	364	54
Satd. Flow (prot)	0	1663	0	1658	1671	0	1658	1633	0	1658	1661	0
Fit Permitted		0.778		0.595			0.355			0.290		
Satd. Flow (perm)	0	1299	0	968	1671	0	568	1633	0	483	1661	0
Satd. Flow (RTOR)					13			25				
Lane Group Flow (vph)	0	266	0	89	622	0	92	528	0	58	464	0
Turn Type	Perm	NA		Perm	NA		Perm	NA		Perm	NA	
Protected Phases		4			8			2			6	
Permitted Phases	4				8			2			6	
Detector Phase	4	4			8	8		2	2		6	6
Switch Phase												
Minimum Initial (s)	10.0	10.0		10.0	10.0		10.0	10.0		10.0	10.0	
Minimum Split (s)	24.5	24.5		24.5	24.5		23.7	23.7		23.7	23.7	
Total Split (s)	33.0	33.0		33.0	33.0		37.0	37.0		37.0	37.0	
Total Split (%)	47.1%	47.1%		47.1%	47.1%		52.9%	52.9%		52.9%	52.9%	
Yellow Time (s)	3.0	3.0		3.0	3.0		3.3	3.3		3.3	3.3	
All-Red Time (s)	3.5	3.5		3.5	3.5		2.4	2.4		2.4	2.4	
Lost Time Adjust (s)		0.0		0.0	0.0		0.0	0.0		0.0	0.0	
Total Lost Time (s)		6.5		6.5	6.5		5.7	5.7		5.7	5.7	
Lead/Lag												
Lead-Lag Optimize?												
Recall Mode	None	None		None	None		C-Min	C-Min		C-Min	C-Min	
Act Effct Green (s)		28.4			28.4		29.4	29.4		29.4	29.4	
Actuated g/C Ratio		0.41			0.41		0.42	0.42		0.42	0.42	
v/c Ratio		0.50			0.23	0.91		0.39	0.76		0.29	0.67
Control Delay		20.0			16.0	40.2		19.7	24.4		17.7	21.8
Queue Delay		0.0			0.0	0.0		0.0	0.0		0.0	0.0
Total Delay		20.0			16.0	40.2		19.7	24.4		17.7	21.8
LOS		C			B	D		B	C		B	C
Approach Delay		20.0				37.2		23.7			21.4	
Approach LOS		C				D		C			C	
Queue Length 50th (m)		23.7			7.0	68.6		8.5	57.0		5.1	49.8
Queue Length 95th (m)		47.8			17.5	#140.8		19.0	85.2		12.7	73.0
Internal Link Dist (m)		300.5				149.8		122.5			139.6	
Turn Bay Length (m)					37.5			24.0			28.0	
Base Capacity (vph)		527			392	686		253	744		215	742
Starvation Cap Reductn		0			0	0		0	0		0	0
Spillback Cap Reductn		0			0	0		0	0		0	0
Storage Cap Reductn		0			0	0		0	0		0	0
Reduced v/c Ratio		0.50			0.23	0.91		0.36	0.71		0.27	0.63
Intersection Summary												
Cycle Length: 70												
Actuated Cycle Length: 70												
Offset: 40 (57%), Referenced to phase 2:NBT and 6:SBTL, Start of Green												
Natural Cycle: 65												
Control Type: Actuated-Coordinated												

Lanes, Volumes, Timings
2: Preston & Gladstone

951 Gladstone & 145 Loretta
Existing - PM Peak Hour

Maximum v/c Ratio: 0.91	Intersection LOS: C
Intersection Signal Delay: 27.2	ICU Level of Service E
Intersection Capacity Utilization 83.9%	
Analysis Period (min) 15	

95th percentile volume exceeds capacity, queue may be longer.
Queue shown is maximum after two cycles.

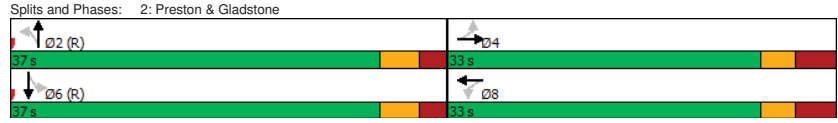

HCM 2010 TWSC
3: Breezehill & Somerset

951 Gladstone & 145 Loretta
Existing - PM Peak Hour

Intersection						
Int Delay, s/veh	1					
Movement	EBT	EBR	WBL	WBT	NBL	NBR
Lane Configurations	↕		↕		↕	
Traffic Vol, veh/h	316	23	19	418	19	15
Future Vol, veh/h	316	23	19	418	19	15
Conflicting Peds, #/hr	0	100	100	0	19	0
Sign Control	Free	Free	Free	Free	Stop	Stop
RT Channelized	-	None	-	None	-	None
Storage Length	-	-	-	-	0	-
Veh in Median Storage, #	0	-	-	0	0	-
Grade, %	0	-	-	0	0	-
Peak Hour Factor	90	90	90	90	90	90
Heavy Vehicles, %	2	2	2	2	2	2
Mvmt Flow	351	26	21	464	21	17
Major/Minor	Major1	Major2	Minor1			
Conflicting Flow All	0	0	477	0	989	464
Stage 1	-	-	-	-	464	-
Stage 2	-	-	-	-	525	-
Critical Hdwy	-	-	4.12	-	6.42	6.22
Critical Hdwy Stg 1	-	-	-	-	5.42	-
Critical Hdwy Stg 2	-	-	-	-	5.42	-
Follow-up Hdwy	-	-	2.218	-	3.518	3.318
Pot Cap-1 Maneuver	-	-	1085	-	274	598
Stage 1	-	-	-	-	633	-
Stage 2	-	-	-	-	593	-
Platoon blocked, %	-	-	-	-	-	-
Mov Cap-1 Maneuver	-	-	1001	-	242	552
Mov Cap-2 Maneuver	-	-	-	-	242	-
Stage 1	-	-	-	-	584	-
Stage 2	-	-	-	-	568	-
Approach	EB	WB	NB			
HCM Control Delay, s	0	0.4	17.7			
HCM LOS			C			
Minor Lane/Major Mvmt	NBLn1	EBT	EBR	WBL	WBT	
Capacity (veh/h)	322	-	-	1001	-	
HCM Lane V/C Ratio	0.117	-	-	0.021	-	
HCM Control Delay (s)	17.7	-	-	8.7	0	
HCM Lane LOS	C	-	-	A	A	
HCM 95th %tile Q(veh)	0.4	-	-	0.1	-	

HCM 2010 TWSC
6: Loretta & Gladstone

951 Gladstone & 145 Loretta
Existing - PM Peak Hour

Intersection												
Int Delay, s/veh	1.5											
Movement	EBL	EBT	EBR	WBL	WBT	WBR	NBL	NBT	NBR	SBL	SBT	SBR
Lane Configurations	↕			↕			↕			↕		
Traffic Vol, veh/h	9	205	4	9	593	31	15	0	6	20	2	16
Future Vol, veh/h	9	205	4	9	593	31	15	0	6	20	2	16
Conflicting Peds, #/hr	23	0	34	34	0	23	2	0	3	3	0	2
Sign Control	Free	Free	Free	Free	Free	Free	Stop	Stop	Stop	Stop	Stop	Stop
RT Channelized	-	-	None	-	-	None	-	-	None	-	-	None
Storage Length	-	-	-	-	-	-	-	-	-	-	-	-
Veh in Median Storage, #	-	0	-	-	0	-	-	0	-	-	0	-
Grade, %	-	0	-	-	0	-	-	0	-	-	0	-
Peak Hour Factor	90	90	90	90	90	90	90	90	90	90	90	90
Heavy Vehicles, %	2	2	2	2	2	2	2	2	2	2	2	2
Mvmt Flow	10	228	4	10	659	34	17	0	7	22	2	18
Major/Minor	Major1	Major2	Minor1	Minor2								
Conflicting Flow All	716	0	0	266	0	0	992	1020	267	976	1005	701
Stage 1	-	-	-	-	-	284	284	-	719	719	-	-
Stage 2	-	-	-	-	-	708	736	-	257	286	-	-
Critical Hdwy	4.12	-	-	4.12	-	7.12	6.52	6.22	7.12	6.52	6.22	-
Critical Hdwy Stg 1	-	-	-	-	-	6.12	5.52	-	6.12	5.52	-	-
Critical Hdwy Stg 2	-	-	-	-	-	6.12	5.52	-	6.12	5.52	-	-
Follow-up Hdwy	2.218	-	-	2.218	-	3.518	4.018	3.318	3.518	4.018	3.318	-
Pot Cap-1 Maneuver	885	-	-	1298	-	225	237	772	230	241	439	-
Stage 1	-	-	-	-	-	723	676	-	420	433	-	-
Stage 2	-	-	-	-	-	426	425	-	748	675	-	-
Platoon blocked, %	-	-	-	-	-	-	-	-	-	-	-	-
Mov Cap-1 Maneuver	869	-	-	1264	-	204	221	750	219	225	430	-
Mov Cap-2 Maneuver	-	-	-	-	-	204	221	-	219	225	-	-
Stage 1	-	-	-	-	-	695	650	-	407	420	-	-
Stage 2	-	-	-	-	-	400	412	-	730	649	-	-
Approach	EB	WB	NB	SB								
HCM Control Delay, s	0.4	0.1	20.3	20.3								
HCM LOS			C	C								
Minor Lane/Major Mvmt	NBLn1	EBL	EBT	EBR	WBL	WBT	WBR	SBLn1				
Capacity (veh/h)	258	869	-	-	1264	-	-	277				
HCM Lane V/C Ratio	0.09	0.012	-	-	0.008	-	-	0.152				
HCM Control Delay (s)	20.3	9.2	0	-	7.9	0	-	20.3				
HCM Lane LOS	C	A	A	-	A	A	-	C				
HCM 95th %tile Q(veh)	0.3	0	-	-	0	-	-	0.5				

HCM 2010 AWSC
7: Breezehill & Laurel

951 Gladstone & 145 Loretta
Existing - PM Peak Hour

Intersection												
Intersection Delay, s/veh	7.4											
Intersection LOS	A											
Movement	EBL	EBT	EBR	WBL	WBT	WBR	NBL	NBT	NBR	SBL	SBT	SBR
Lane Configurations	↕			↕			↕			↕		
Traffic Vol, veh/h	12	8	10	4	22	6	24	22	1	3	45	32
Future Vol, veh/h	12	8	10	4	22	6	24	22	1	3	45	32
Peak Hour Factor	0.90	0.90	0.90	0.90	0.90	0.90	0.90	0.90	0.90	0.90	0.90	0.90
Heavy Vehicles, %	2	2	2	2	2	2	2	2	2	2	2	2
Mvmt Flow	13	9	11	4	24	7	27	24	1	3	50	36
Number of Lanes	0	1	0	0	1	0	0	1	0	0	1	0
Approach	EB	WB	NB	SB								
Opposing Approach	WB	EB	SB	NB								
Opposing Lanes	1	1	1	1								
Conflicting Approach Left	SB	NB	EB	WB								
Conflicting Lanes Left	1	1	1	1								
Conflicting Approach Right	NB	SB	WB	EB								
Conflicting Lanes Right	1	1	1	1								
HCM Control Delay	7.3	7.4	7.5	7.3								
HCM LOS	A	A	A	A								
Lane	NBLn1	EBLn1	WBLn1	SBLn1								
Vol Left, %	51%	40%	12%	4%								
Vol Thru, %	47%	27%	69%	56%								
Vol Right, %	2%	33%	19%	40%								
Sign Control	Stop	Stop	Stop	Stop								
Traffic Vol by Lane	47	30	32	80								
LT Vol	24	12	4	3								
Through Vol	22	8	22	45								
RT Vol	1	10	6	32								
Lane Flow Rate	52	33	36	89								
Geometry Grp	1	1	1	1								
Degree of Util (X)	0.061	0.038	0.041	0.095								
Departure Headway (Hd)	4.212	4.085	4.116	3.862								
Convergence, Y/N	Yes	Yes	Yes	Yes								
Cap	846	867	861	923								
Service Time	2.26	2.153	2.183	1.908								
HCM Lane V/C Ratio	0.061	0.038	0.042	0.096								
HCM Control Delay	7.5	7.3	7.4	7.3								
HCM Lane LOS	A	A	A	A								
HCM 95th %tile Q	0.2	0.1	0.1	0.3								

Lanes, Volumes, Timings
8: Bayswater & Gladstone

951 Gladstone & 145 Loretta
Existing - PM Peak Hour

Lane Group	EBL	EBT	EBR	WBL	WBT	WBR	NBL	NBT	NBR	SBL	SBT	SBR
Lane Configurations		↔			↔			↔			↔	
Traffic Volume (vph)	10	147	18	74	429	114	29	182	28	35	206	34
Future Volume (vph)	10	147	18	74	429	114	29	182	28	35	206	34
Satd. Flow (prot)	0	1701	0	0	1661	0	0	1698	0	0	1694	0
Fit Permitted		0.960			0.937			0.938			0.934	
Satd. Flow (perm)	0	1636	0	0	1558	0	0	1600	0	0	1589	0
Satd. Flow (RTOR)		14			28			12			12	
Lane Group Flow (vph)	0	194	0	0	686	0	0	265	0	0	306	0
Turn Type	Perm	NA		Perm	NA		Perm	NA		Perm	NA	
Protected Phases		2			6			8			4	
Permitted Phases	2			6			8			4		
Detector Phase	2	2		6	6		8	8		4	4	
Switch Phase												
Minimum Initial (s)	10.0	10.0		10.0	10.0		10.0	10.0		10.0	10.0	
Minimum Split (s)	22.5	22.5		22.5	22.5		22.5	22.5		22.5	22.5	
Total Split (s)	36.0	36.0		36.0	36.0		24.0	24.0		24.0	24.0	
Total Split (%)	60.0%	60.0%		60.0%	60.0%		40.0%	40.0%		40.0%	40.0%	
Yellow Time (s)	3.0	3.0		3.0	3.0		3.3	3.3		3.3	3.3	
All-Red Time (s)	2.5	2.5		2.5	2.5		2.0	2.0		2.0	2.0	
Lost Time Adjust (s)		0.0			0.0			0.0			0.0	
Total Lost Time (s)		5.5			5.5			5.3			5.3	
Lead/Lag												
Lead-Lag Optimize?												
Recall Mode	C-Max	C-Max		C-Max	C-Max		Max	Max		Max	Max	
Act Effct Green (s)		30.5			30.5			18.7			18.7	
Actuated g/C Ratio		0.51			0.51			0.31			0.31	
v/c Ratio		0.23			0.85			0.52			0.61	
Control Delay		8.5			25.5			20.7			23.0	
Queue Delay		0.0			0.0			0.0			0.0	
Total Delay		8.5			25.5			20.7			23.0	
LOS		A			C			C			C	
Approach Delay		8.5			25.5			20.7			23.0	
Approach LOS		A			C			C			C	
Queue Length 50th (m)		10.1			57.9			22.4			27.0	
Queue Length 95th (m)		19.8			#121.1			41.7			49.3	
Internal Link Dist (m)		95.1			81.5			119.0			98.4	
Turn Bay Length (m)												
Base Capacity (vph)		838			805			506			503	
Starvation Cap Reductn		0			0			0			0	
Spillback Cap Reductn		0			0			0			0	
Storage Cap Reductn		0			0			0			0	
Reduced v/c Ratio		0.23			0.85			0.52			0.61	
Intersection Summary												
Cycle Length: 60												
Actuated Cycle Length: 60												
Offset: 53 (88%), Referenced to phase 2:EBTL and 6:WBTL, Start of Green												
Natural Cycle: 60												
Control Type: Actuated-Coordinated												

Lanes, Volumes, Timings
8: Bayswater & Gladstone

951 Gladstone & 145 Loretta
Existing - PM Peak Hour

Maximum v/c Ratio: 0.85	Intersection Signal Delay: 21.8	Intersection LOS: C
Intersection Capacity Utilization 84.1%	ICU Level of Service E	
Analysis Period (min) 15		
# 95th percentile volume exceeds capacity, queue may be longer.		
Queue shown is maximum after two cycles.		



Appendix D

Collision Data

Appendix E

TDM Checklist

TDM Measures Checklist:
Non-Residential Developments (office, institutional, retail or industrial)

Legend	
BASIC	The measure is generally feasible and effective, and in most cases would benefit the development and its users
BETTER	The measure could maximize support for users of sustainable modes, and optimize development performance
★	The measure is one of the most dependably effective tools to encourage the use of sustainable modes

TDM measures: <i>Non-residential developments</i>		Check if proposed & add descriptions
1. TDM PROGRAM MANAGEMENT		
1.1 Program coordinator		
BASIC	★ 1.1.1 Designate an internal coordinator, or contract with an external coordinator	<input checked="" type="checkbox"/>
1.2 Travel surveys		
BETTER	1.2.1 Conduct periodic surveys to identify travel-related behaviours, attitudes, challenges and solutions, and to track progress	<input type="checkbox"/>
2. WALKING AND CYCLING		
2.1 Information on walking/cycling routes & destinations		
BASIC	2.1.1 Display local area maps with walking/cycling access routes and key destinations at major entrances	<input checked="" type="checkbox"/>
2.2 Bicycle skills training		
<i>Commuter travel</i>		
BETTER	★ 2.2.1 Offer on-site cycling courses for commuters, or subsidize off-site courses	<input type="checkbox"/>
2.3 Valet bike parking		
<i>Visitor travel</i>		
BETTER	2.3.1 Offer secure valet bike parking during public events when demand exceeds fixed supply (e.g. for festivals, concerts, games)	<input type="checkbox"/>

TDM measures: <i>Non-residential developments</i>		Check if proposed & add descriptions
3. TRANSIT		
3.1 Transit information		
BASIC	3.1.1 Display relevant transit schedules and route maps at entrances	<input checked="" type="checkbox"/>
BASIC	3.1.2 Provide online links to OC Transpo and STO information	<input checked="" type="checkbox"/>
BETTER	3.1.3 Provide real-time arrival information display at entrances	<input type="checkbox"/>
3.2 Transit fare incentives		
<i>Commuter travel</i>		
BETTER	3.2.1 Offer preloaded PRESTO cards to encourage commuters to use transit	<input checked="" type="checkbox"/>
BETTER	★ 3.2.2 Subsidize or reimburse monthly transit pass purchases by employees	<input type="checkbox"/>
<i>Visitor travel</i>		
BETTER	3.2.3 Arrange inclusion of same-day transit fare in price of tickets (e.g. for festivals, concerts, games)	<input type="checkbox"/>
3.3 Enhanced public transit service		
<i>Commuter travel</i>		
BETTER	3.3.1 Contract with OC Transpo to provide enhanced transit services (e.g. for shift changes, weekends)	<input type="checkbox"/>
<i>Visitor travel</i>		
BETTER	3.3.2 Contract with OC Transpo to provide enhanced transit services (e.g. for festivals, concerts, games)	<input type="checkbox"/>
3.4 Private transit service		
<i>Commuter travel</i>		
BETTER	3.4.1 Provide shuttle service when OC Transpo cannot offer sufficient quality or capacity to serve demand (e.g. for shift changes, weekends)	<input type="checkbox"/>
<i>Visitor travel</i>		
BETTER	3.4.2 Provide shuttle service when OC Transpo cannot offer sufficient quality or capacity to serve demand (e.g. for festivals, concerts, games)	<input type="checkbox"/>

TDM measures: <i>Non-residential developments</i>		Check if proposed & add descriptions
4. RIDESHARING		
4.1 Ridematching service		
<i>Commuter travel</i>		
BASIC ★	4.1.1 Provide a dedicated ridematching portal at OttawaRideMatch.com	<input type="checkbox"/>
4.2 Carpool parking price incentives		
<i>Commuter travel</i>		
BETTER	4.2.1 Provide discounts on parking costs for registered carpools	<input type="checkbox"/>
4.3 Vanpool service		
<i>Commuter travel</i>		
BETTER	4.3.1 Provide a vanpooling service for long-distance commuters	<input type="checkbox"/>
5. CARSHARING & BIKESHARING		
5.1 Bikeshare stations & memberships		
BETTER	5.1.1 Contract with provider to install on-site bikeshare station for use by commuters and visitors	<input checked="" type="checkbox"/>
<i>Commuter travel</i>		
BETTER	5.1.2 Provide employees with bikeshare memberships for local business travel	<input type="checkbox"/>
5.2 Carshare vehicles & memberships		
<i>Commuter travel</i>		
BETTER	5.2.1 Contract with provider to install on-site carshare vehicles and promote their use by tenants	<input checked="" type="checkbox"/>
BETTER	5.2.2 Provide employees with carshare memberships for local business travel	<input type="checkbox"/>
6. PARKING		
6.1 Priced parking		
<i>Commuter travel</i>		
BASIC ★	6.1.1 Charge for long-term parking (daily, weekly, monthly)	<input type="checkbox"/>
BASIC	6.1.2 Unbundle parking cost from lease rates at multi-tenant sites	<input checked="" type="checkbox"/>
<i>Visitor travel</i>		
BETTER	6.1.3 Charge for short-term parking (hourly)	<input checked="" type="checkbox"/>

TDM measures: <i>Non-residential developments</i>		Check if proposed & add descriptions
7. TDM MARKETING & COMMUNICATIONS		
7.1 Multimodal travel information		
<i>Commuter travel</i>		
BASIC ★	7.1.1 Provide a multimodal travel option information package to new/relocating employees and students	<input checked="" type="checkbox"/>
<i>Visitor travel</i>		
BETTER ★	7.1.2 Include multimodal travel option information in invitations or advertising that attract visitors or customers (e.g. for festivals, concerts, games)	<input type="checkbox"/>
7.2 Personalized trip planning		
<i>Commuter travel</i>		
BETTER ★	7.2.1 Offer personalized trip planning to new/relocating employees	<input type="checkbox"/>
7.3 Promotions		
<i>Commuter travel</i>		
BETTER	7.3.1 Deliver promotions and incentives to maintain awareness, build understanding, and encourage trial of sustainable modes	<input type="checkbox"/>
8. OTHER INCENTIVES & AMENITIES		
8.1 Emergency ride home		
<i>Commuter travel</i>		
BETTER ★	8.1.1 Provide emergency ride home service to non-driving commuters	<input type="checkbox"/>
8.2 Alternative work arrangements		
<i>Commuter travel</i>		
BASIC ★	8.2.1 Encourage flexible work hours	<input type="checkbox"/>
BETTER	8.2.2 Encourage compressed workweeks	<input type="checkbox"/>
BETTER ★	8.2.3 Encourage telework	<input type="checkbox"/>
8.3 Local business travel options		
<i>Commuter travel</i>		
BASIC ★	8.3.1 Provide local business travel options that minimize the need for employees to bring a personal car to work	<input type="checkbox"/>
8.4 Commuter incentives		
<i>Commuter travel</i>		
BETTER	8.4.1 Offer employees a taxable, mode-neutral commuting allowance	<input type="checkbox"/>
8.5 On-site amenities		
<i>Commuter travel</i>		
BETTER	8.5.1 Provide on-site amenities/services to minimize mid-day or mid-commute errands	<input type="checkbox"/>

TDM Measures Checklist:
Residential Developments (multi-family, condominium or subdivision)

Legend	
BASIC	The measure is generally feasible and effective, and in most cases would benefit the development and its users
BETTER	The measure could maximize support for users of sustainable modes, and optimize development performance
★	The measure is one of the most dependably effective tools to encourage the use of sustainable modes

TDM measures: Residential developments		Check if proposed & add descriptions
1. TDM PROGRAM MANAGEMENT		
1.1 Program coordinator		
BASIC ★	1.1.1 Designate an internal coordinator, or contract with an external coordinator	<input checked="" type="checkbox"/>
1.2 Travel surveys		
BETTER	1.2.1 Conduct periodic surveys to identify travel-related behaviours, attitudes, challenges and solutions, and to track progress	<input checked="" type="checkbox"/>
2. WALKING AND CYCLING		
2.1 Information on walking/cycling routes & destinations		
BASIC	2.1.1 Display local area maps with walking/cycling access routes and key destinations at major entrances (<i>multi-family, condominium</i>)	<input checked="" type="checkbox"/>
2.2 Bicycle skills training		
BETTER	2.2.1 Offer on-site cycling courses for residents, or subsidize off-site courses	<input type="checkbox"/>

TDM measures: Residential developments		Check if proposed & add descriptions
3. TRANSIT		
3.1 Transit information		
BASIC	3.1.1 Display relevant transit schedules and route maps at entrances (<i>multi-family, condominium</i>)	<input checked="" type="checkbox"/>
BETTER	3.1.2 Provide real-time arrival information display at entrances (<i>multi-family, condominium</i>)	<input type="checkbox"/>
3.2 Transit fare incentives		
BASIC ★	3.2.1 Offer PRESTO cards preloaded with one monthly transit pass on residence purchase/move-in, to encourage residents to use transit	<input type="checkbox"/>
BETTER	3.2.2 Offer at least one year of free monthly transit passes on residence purchase/move-in	<input checked="" type="checkbox"/>
3.3 Enhanced public transit service		
BETTER ★	3.3.1 Contract with OC Transpo to provide early transit services until regular services are warranted by occupancy levels (<i>subdivision</i>)	<input type="checkbox"/>
3.4 Private transit service		
BETTER	3.4.1 Provide shuttle service for seniors homes or lifestyle communities (e.g. scheduled mall or supermarket runs)	<input type="checkbox"/>
4. CARSHARING & BIKESHARING		
4.1 Bikeshare stations & memberships		
BETTER	4.1.1 Contract with provider to install on-site bikeshare station (<i>multi-family</i>)	<input checked="" type="checkbox"/>
BETTER	4.1.2 Provide residents with bikeshare memberships, either free or subsidized (<i>multi-family</i>)	<input type="checkbox"/>
4.2 Carshare vehicles & memberships		
BETTER	4.2.1 Contract with provider to install on-site carshare vehicles and promote their use by residents	<input checked="" type="checkbox"/>
BETTER	4.2.2 Provide residents with carshare memberships, either free or subsidized	<input type="checkbox"/>
5. PARKING		
5.1 Priced parking		
BASIC ★	5.1.1 Unbundle parking cost from purchase price (<i>condominium</i>)	<input checked="" type="checkbox"/>
BASIC ★	5.1.2 Unbundle parking cost from monthly rent (<i>multi-family</i>)	<input checked="" type="checkbox"/>

TDM measures: Residential developments		Check if proposed & add descriptions
6. TDM MARKETING & COMMUNICATIONS		
6.1 Multimodal travel information		
BASIC ★	6.1.1 Provide a multimodal travel option information package to new residents	<input type="checkbox"/>
6.2 Personalized trip planning		
BETTER ★	6.2.1 Offer personalized trip planning to new residents	<input type="checkbox"/>

TDM-Supportive Development Design and Infrastructure Checklist:
Non-Residential Developments (office, institutional, retail or industrial)

Legend	
REQUIRED	The Official Plan or Zoning By-law provides related guidance that must be followed
BASIC	The measure is generally feasible and effective, and in most cases would benefit the development and its users
BETTER	The measure could maximize support for users of sustainable modes, and optimize development performance

TDM-supportive design & infrastructure measures: Non-residential developments		Check if completed & add descriptions, explanations or plan/drawing references
1. WALKING & CYCLING: ROUTES		
1.1 Building location & access points		
BASIC	1.1.1 Locate building close to the street, and do not locate parking areas between the street and building entrances	<input checked="" type="checkbox"/>
BASIC	1.1.2 Locate building entrances in order to minimize walking distances to sidewalks and transit stops/stations	<input checked="" type="checkbox"/>
BASIC	1.1.3 Locate building doors and windows to ensure visibility of pedestrians from the building, for their security and comfort	<input checked="" type="checkbox"/>
1.2 Facilities for walking & cycling		
REQUIRED	1.2.1 Provide convenient, direct access to stations or major stops along rapid transit routes within 600 metres; minimize walking distances from buildings to rapid transit; provide pedestrian-friendly, weather-protected (where possible) environment between rapid transit accesses and building entrances; ensure quality linkages from sidewalks through building entrances to integrated stops/stations (see Official Plan policy 4.3.3)	<input checked="" type="checkbox"/>
REQUIRED	1.2.2 Provide safe, direct and attractive pedestrian access from public sidewalks to building entrances through such measures as: reducing distances between public sidewalks and major building entrances; providing walkways from public streets to major building entrances; within a site, providing walkways along the front of adjoining buildings, between adjacent buildings, and connecting areas where people may congregate, such as courtyards and transit stops; and providing weather protection through canopies, colonnades, and other design elements wherever possible (see Official Plan policy 4.3.12)	<input checked="" type="checkbox"/>

TDM-supportive design & infrastructure measures: <i>Non-residential developments</i>		Check if completed & add descriptions, explanations or plan/drawing references
REQUIRED	1.2.3 Provide sidewalks of smooth, well-drained walking surfaces of contrasting materials or treatments to differentiate pedestrian areas from vehicle areas, and provide marked pedestrian crosswalks at intersection sidewalks (see <i>Official Plan policy 4.3.10</i>)	<input checked="" type="checkbox"/>
REQUIRED	1.2.4 Make sidewalks and open space areas easily accessible through features such as gradual grade transition, depressed curbs at street corners and convenient access to extra-wide parking spaces and ramps (see <i>Official Plan policy 4.3.10</i>)	<input checked="" type="checkbox"/>
REQUIRED	1.2.5 Include adequately spaced inter-block/street cycling and pedestrian connections to facilitate travel by active transportation. Provide links to the existing or planned network of public sidewalks, multi-use pathways and on-road cycle routes. Where public sidewalks and multi-use pathways intersect with roads, consider providing traffic control devices to give priority to cyclists and pedestrians (see <i>Official Plan policy 4.3.11</i>)	<input checked="" type="checkbox"/>
BASIC	1.2.6 Provide safe, direct and attractive walking routes from building entrances to nearby transit stops	<input checked="" type="checkbox"/>
BASIC	1.2.7 Ensure that walking routes to transit stops are secure, visible, lighted, shaded and wind-protected wherever possible	<input checked="" type="checkbox"/>
BASIC	1.2.8 Design roads used for access or circulation by cyclists using a target operating speed of no more than 30 km/h, or provide a separated cycling facility	<input type="checkbox"/>
1.3 Amenities for walking & cycling		
BASIC	1.3.1 Provide lighting, landscaping and benches along walking and cycling routes between building entrances and streets, sidewalks and trails	<input checked="" type="checkbox"/>
BASIC	1.3.2 Provide wayfinding signage for site access (where required, e.g. when multiple buildings or entrances exist) and egress (where warranted, such as when directions to reach transit stops/stations, trails or other common destinations are not obvious)	<input checked="" type="checkbox"/>

TDM-supportive design & infrastructure measures: <i>Non-residential developments</i>		Check if completed & add descriptions, explanations or plan/drawing references
2. WALKING & CYCLING: END-OF-TRIP FACILITIES		
2.1 Bicycle parking		
REQUIRED	2.1.1 Provide bicycle parking in highly visible and lighted areas, sheltered from the weather wherever possible (see <i>Official Plan policy 4.3.6</i>)	<input checked="" type="checkbox"/>
REQUIRED	2.1.2 Provide the number of bicycle parking spaces specified for various land uses in different parts of Ottawa; provide convenient access to main entrances or well-used areas (see <i>Zoning By-law Section 111</i>)	<input checked="" type="checkbox"/>
REQUIRED	2.1.3 Ensure that bicycle parking spaces and access aisles meet minimum dimensions; that no more than 50% of spaces are vertical spaces; and that parking racks are securely anchored (see <i>Zoning By-law Section 111</i>)	<input checked="" type="checkbox"/>
BASIC	2.1.4 Provide bicycle parking spaces equivalent to the expected number of commuter cyclists (assuming the cycling mode share target is met), plus the expected peak number of customer/visitor cyclists	<input type="checkbox"/>
BETTER	2.1.5 Provide bicycle parking spaces equivalent to the expected number of commuter and customer/visitor cyclists, plus an additional buffer (e.g. 25 percent extra) to encourage other cyclists and ensure adequate capacity in peak cycling season	<input type="checkbox"/>
2.2 Secure bicycle parking		
REQUIRED	2.2.1 Where more than 50 bicycle parking spaces are provided for a single office building, locate at least 25% of spaces within a building/structure, a secure area (e.g. supervised parking lot or enclosure) or bicycle lockers (see <i>Zoning By-law Section 111</i>)	<input checked="" type="checkbox"/>
BETTER	2.2.2 Provide secure bicycle parking spaces equivalent to the expected number of commuter cyclists (assuming the cycling mode share target is met)	<input type="checkbox"/>
2.3 Shower & change facilities		
BASIC	2.3.1 Provide shower and change facilities for the use of active commuters	<input type="checkbox"/>
BETTER	2.3.2 In addition to shower and change facilities, provide dedicated lockers, grooming stations, drying racks and laundry facilities for the use of active commuters	<input type="checkbox"/>
2.4 Bicycle repair station		
BETTER	2.4.1 Provide a permanent bike repair station, with commonly used tools and an air pump, adjacent to the main bicycle parking area (or secure bicycle parking area, if provided)	<input checked="" type="checkbox"/>

TDM-supportive design & infrastructure measures: <i>Non-residential developments</i>		Check if completed & add descriptions, explanations or plan/drawing references
3. TRANSIT		
3.1 Customer amenities		
BASIC	3.1.1 Provide shelters, lighting and benches at any on-site transit stops	<input type="checkbox"/>
BASIC	3.1.2 Where the site abuts an off-site transit stop and insufficient space exists for a transit shelter in the public right-of-way, protect land for a shelter and/or install a shelter	<input type="checkbox"/>
BETTER	3.1.3 Provide a secure and comfortable interior waiting area by integrating any on-site transit stops into the building	<input checked="" type="checkbox"/>
4. RIDESHARING		
4.1 Pick-up & drop-off facilities		
BASIC	4.1.1 Provide a designated area for carpool drivers (plus taxis and ride-hailing services) to drop off or pick up passengers without using fire lanes or other no-stopping zones	<input type="checkbox"/>
4.2 Carpool parking		
BASIC	4.2.1 Provide signed parking spaces for carpools in a priority location close to a major building entrance, sufficient in number to accommodate the mode share target for carpools	<input type="checkbox"/>
BETTER	4.2.2 At large developments, provide spaces for carpools in a separate, access-controlled parking area to simplify enforcement	<input type="checkbox"/>
5. CARSHARING & BIKESHARING		
5.1 Carshare parking spaces		
BETTER	5.1.1 Provide carshare parking spaces in permitted non-residential zones, occupying either required or provided parking spaces (<i>see Zoning By-law Section 94</i>)	<input checked="" type="checkbox"/>
5.2 Bikeshare station location		
BETTER	5.2.1 Provide a designated bikeshare station area near a major building entrance, preferably lighted and sheltered with a direct walkway connection	<input checked="" type="checkbox"/>

TDM-supportive design & infrastructure measures: <i>Non-residential developments</i>		Check if completed & add descriptions, explanations or plan/drawing references
6. PARKING		
6.1 Number of parking spaces		
REQUIRED	6.1.1 Do not provide more parking than permitted by zoning, nor less than required by zoning, unless a variance is being applied for	<input checked="" type="checkbox"/>
BASIC	6.1.2 Provide parking for long-term and short-term users that is consistent with mode share targets, considering the potential for visitors to use off-site public parking	<input type="checkbox"/>
BASIC	6.1.3 Where a site features more than one use, provide shared parking and reduce the cumulative number of parking spaces accordingly (<i>see Zoning By-law Section 104</i>)	<input checked="" type="checkbox"/>
BETTER	6.1.4 Reduce the minimum number of parking spaces required by zoning by one space for each 13 square metres of gross floor area provided as shower rooms, change rooms, locker rooms and other facilities for cyclists in conjunction with bicycle parking (<i>see Zoning By-law Section 111</i>)	<input type="checkbox"/>
6.2 Separate long-term & short-term parking areas		
BETTER	6.2.1 Separate short-term and long-term parking areas using signage or physical barriers, to permit access controls and simplify enforcement (i.e. to discourage employees from parking in visitor spaces, and vice versa)	<input type="checkbox"/>
7. OTHER		
7.1 On-site amenities to minimize off-site trips		
BETTER	7.1.1 Provide on-site amenities to minimize mid-day or mid-commute errands	<input type="checkbox"/>

TDM-Supportive Development Design and Infrastructure Checklist:
Residential Developments (multi-family or condominium)

Legend	
REQUIRED	The Official Plan or Zoning By-law provides related guidance that must be followed
BASIC	The measure is generally feasible and effective, and in most cases would benefit the development and its users
BETTER	The measure could maximize support for users of sustainable modes, and optimize development performance

TDM-supportive design & infrastructure measures: <i>Residential developments</i>		Check if completed & add descriptions, explanations or plan/drawing references
1. WALKING & CYCLING: ROUTES		
1.1 Building location & access points		
BASIC	1.1.1 Locate building close to the street, and do not locate parking areas between the street and building entrances	<input checked="" type="checkbox"/>
BASIC	1.1.2 Locate building entrances in order to minimize walking distances to sidewalks and transit stops/stations	<input checked="" type="checkbox"/>
BASIC	1.1.3 Locate building doors and windows to ensure visibility of pedestrians from the building, for their security and comfort	<input checked="" type="checkbox"/>
1.2 Facilities for walking & cycling		
REQUIRED	1.2.1 Provide convenient, direct access to stations or major stops along rapid transit routes within 600 metres; minimize walking distances from buildings to rapid transit; provide pedestrian-friendly, weather-protected (where possible) environment between rapid transit accesses and building entrances; ensure quality linkages from sidewalks through building entrances to integrated stops/stations (see <i>Official Plan policy 4.3.3</i>)	<input checked="" type="checkbox"/>
REQUIRED	1.2.2 Provide safe, direct and attractive pedestrian access from public sidewalks to building entrances through such measures as: reducing distances between public sidewalks and major building entrances; providing walkways from public streets to major building entrances; within a site, providing walkways along the front of adjoining buildings, between adjacent buildings, and connecting areas where people may congregate, such as courtyards and transit stops; and providing weather protection through canopies, colonnades, and other design elements wherever possible (see <i>Official Plan policy 4.3.12</i>)	<input checked="" type="checkbox"/>

TDM-supportive design & infrastructure measures: <i>Residential developments</i>		Check if completed & add descriptions, explanations or plan/drawing references
REQUIRED	1.2.3 Provide sidewalks of smooth, well-drained walking surfaces of contrasting materials or treatments to differentiate pedestrian areas from vehicle areas, and provide marked pedestrian crosswalks at intersection sidewalks (see <i>Official Plan policy 4.3.10</i>)	<input checked="" type="checkbox"/>
REQUIRED	1.2.4 Make sidewalks and open space areas easily accessible through features such as gradual grade transition, depressed curbs at street corners and convenient access to extra-wide parking spaces and ramps (see <i>Official Plan policy 4.3.10</i>)	<input checked="" type="checkbox"/>
REQUIRED	1.2.5 Include adequately spaced inter-block/street cycling and pedestrian connections to facilitate travel by active transportation. Provide links to the existing or planned network of public sidewalks, multi-use pathways and on-road cycle routes. Where public sidewalks and multi-use pathways intersect with roads, consider providing traffic control devices to give priority to cyclists and pedestrians (see <i>Official Plan policy 4.3.11</i>)	<input checked="" type="checkbox"/>
BASIC	1.2.6 Provide safe, direct and attractive walking routes from building entrances to nearby transit stops	<input checked="" type="checkbox"/>
BASIC	1.2.7 Ensure that walking routes to transit stops are secure, visible, lighted, shaded and wind-protected wherever possible	<input checked="" type="checkbox"/>
BASIC	1.2.8 Design roads used for access or circulation by cyclists using a target operating speed of no more than 30 km/h, or provide a separated cycling facility	<input type="checkbox"/>
1.3 Amenities for walking & cycling		
BASIC	1.3.1 Provide lighting, landscaping and benches along walking and cycling routes between building entrances and streets, sidewalks and trails	<input checked="" type="checkbox"/>
BASIC	1.3.2 Provide wayfinding signage for site access (where required, e.g. when multiple buildings or entrances exist) and egress (where warranted, such as when directions to reach transit stops/stations, trails or other common destinations are not obvious)	<input checked="" type="checkbox"/>

TDM-supportive design & infrastructure measures: <i>Residential developments</i>		Check if completed & add descriptions, explanations or plan/drawing references
2. WALKING & CYCLING: END-OF-TRIP FACILITIES		
2.1 Bicycle parking		
REQUIRED	2.1.1 Provide bicycle parking in highly visible and lighted areas, sheltered from the weather wherever possible (see <i>Official Plan policy 4.3.6</i>)	<input checked="" type="checkbox"/>
REQUIRED	2.1.2 Provide the number of bicycle parking spaces specified for various land uses in different parts of Ottawa; provide convenient access to main entrances or well-used areas (see <i>Zoning By-law Section 111</i>)	<input checked="" type="checkbox"/>
REQUIRED	2.1.3 Ensure that bicycle parking spaces and access aisles meet minimum dimensions; that no more than 50% of spaces are vertical spaces; and that parking racks are securely anchored (see <i>Zoning By-law Section 111</i>)	<input checked="" type="checkbox"/>
BASIC	2.1.4 Provide bicycle parking spaces equivalent to the expected number of resident-owned bicycles, plus the expected peak number of visitor cyclists	<input type="checkbox"/>
2.2 Secure bicycle parking		
REQUIRED	2.2.1 Where more than 50 bicycle parking spaces are provided for a single residential building, locate at least 25% of spaces within a building/structure, a secure area (e.g. supervised parking lot or enclosure) or bicycle lockers (see <i>Zoning By-law Section 111</i>)	<input checked="" type="checkbox"/>
BETTER	2.2.2 Provide secure bicycle parking spaces equivalent to at least the number of units at condominiums or multi-family residential developments	<input type="checkbox"/>
2.3 Bicycle repair station		
BETTER	2.3.1 Provide a permanent bike repair station, with commonly used tools and an air pump, adjacent to the main bicycle parking area (or secure bicycle parking area, if provided)	<input checked="" type="checkbox"/>
3. TRANSIT		
3.1 Customer amenities		
BASIC	3.1.1 Provide shelters, lighting and benches at any on-site transit stops	<input type="checkbox"/>
BASIC	3.1.2 Where the site abuts an off-site transit stop and insufficient space exists for a transit shelter in the public right-of-way, protect land for a shelter and/or install a shelter	<input type="checkbox"/>
BETTER	3.1.3 Provide a secure and comfortable interior waiting area by integrating any on-site transit stops into the building	<input checked="" type="checkbox"/>

TDM-supportive design & infrastructure measures: <i>Residential developments</i>		Check if completed & add descriptions, explanations or plan/drawing references
4. RIDESHARING		
4.1 Pick-up & drop-off facilities		
BASIC	4.1.1 Provide a designated area for carpool drivers (plus taxis and ride-hailing services) to drop off or pick up passengers without using fire lanes or other no-stopping zones	<input type="checkbox"/>
5. CARSHARING & BIKESHARING		
5.1 Carshare parking spaces		
BETTER	5.1.1 Provide up to three carshare parking spaces in an R3, R4 or R5 Zone for specified residential uses (see <i>Zoning By-law Section 94</i>)	<input type="checkbox"/>
5.2 Bikeshare station location		
BETTER	5.2.1 Provide a designated bikeshare station area near a major building entrance, preferably lighted and sheltered with a direct walkway connection	<input checked="" type="checkbox"/>
6. PARKING		
6.1 Number of parking spaces		
REQUIRED	6.1.1 Do not provide more parking than permitted by zoning, nor less than required by zoning, unless a variance is being applied for	<input checked="" type="checkbox"/>
BASIC	6.1.2 Provide parking for long-term and short-term users that is consistent with mode share targets, considering the potential for visitors to use off-site public parking	<input type="checkbox"/>
BASIC	6.1.3 Where a site features more than one use, provide shared parking and reduce the cumulative number of parking spaces accordingly (see <i>Zoning By-law Section 104</i>)	<input checked="" type="checkbox"/>
BETTER	6.1.4 Reduce the minimum number of parking spaces required by zoning by one space for each 13 square metres of gross floor area provided as shower rooms, change rooms, locker rooms and other facilities for cyclists in conjunction with bicycle parking (see <i>Zoning By-law Section 111</i>)	<input type="checkbox"/>
6.2 Separate long-term & short-term parking areas		
BETTER	6.2.1 Provide separate areas for short-term and long-term parking (using signage or physical barriers) to permit access controls and simplify enforcement (i.e. to discourage residents from parking in visitor spaces, and vice versa)	<input type="checkbox"/>

Appendix F

Turning Templates

HSU Inbound Movement - Northbound

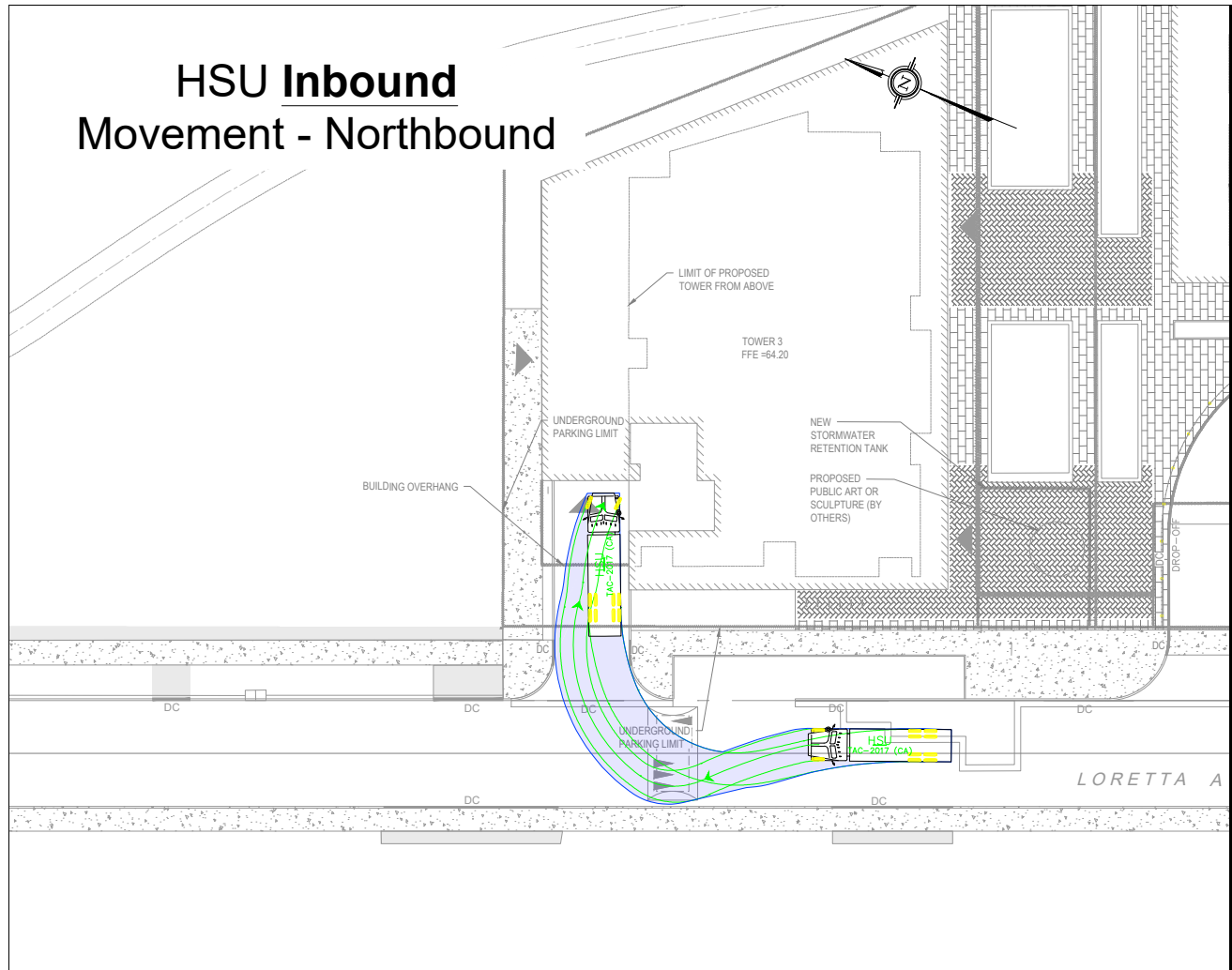

HSU Inbound Movement - Southbound

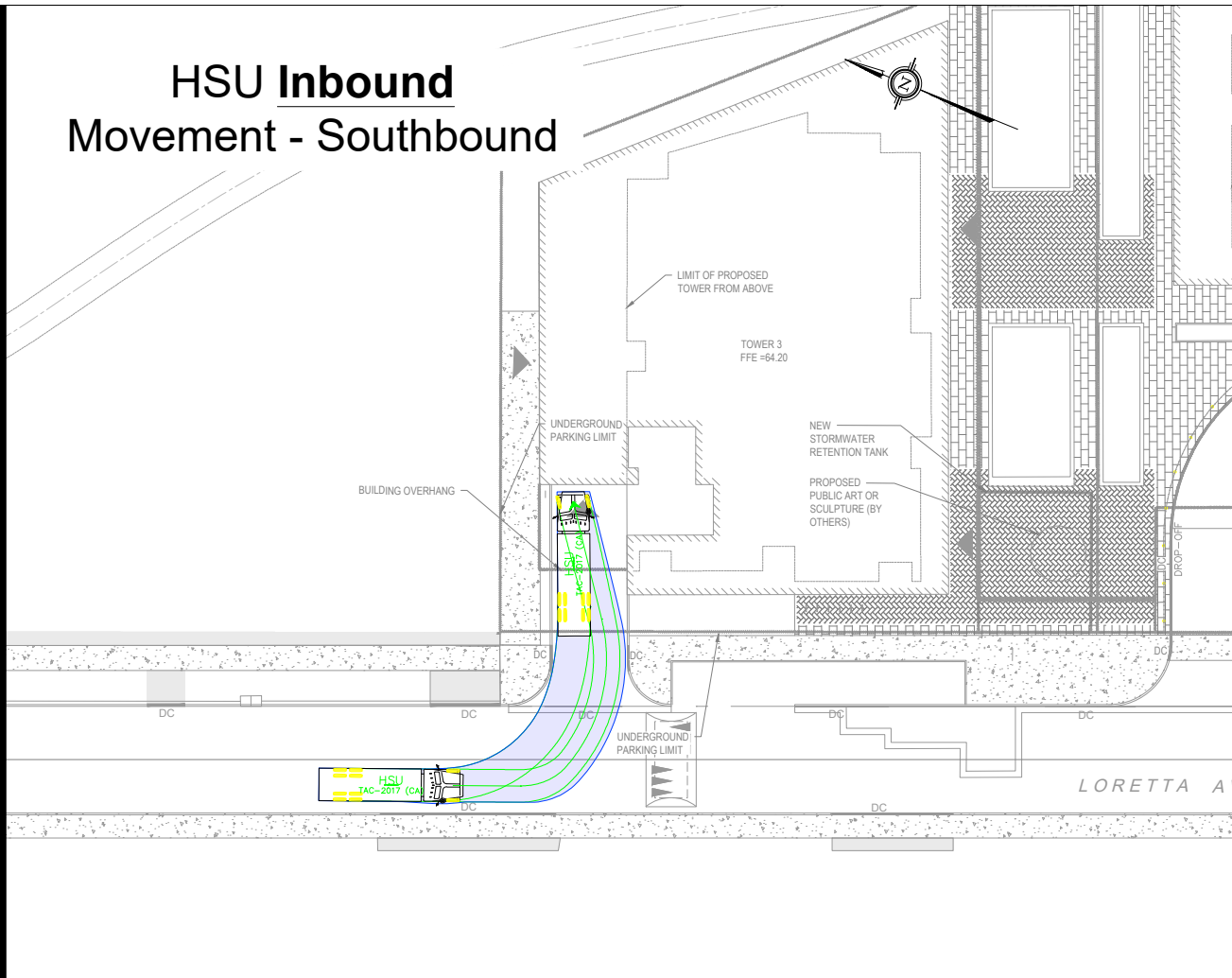

HSU Outbound Movement - Northbound

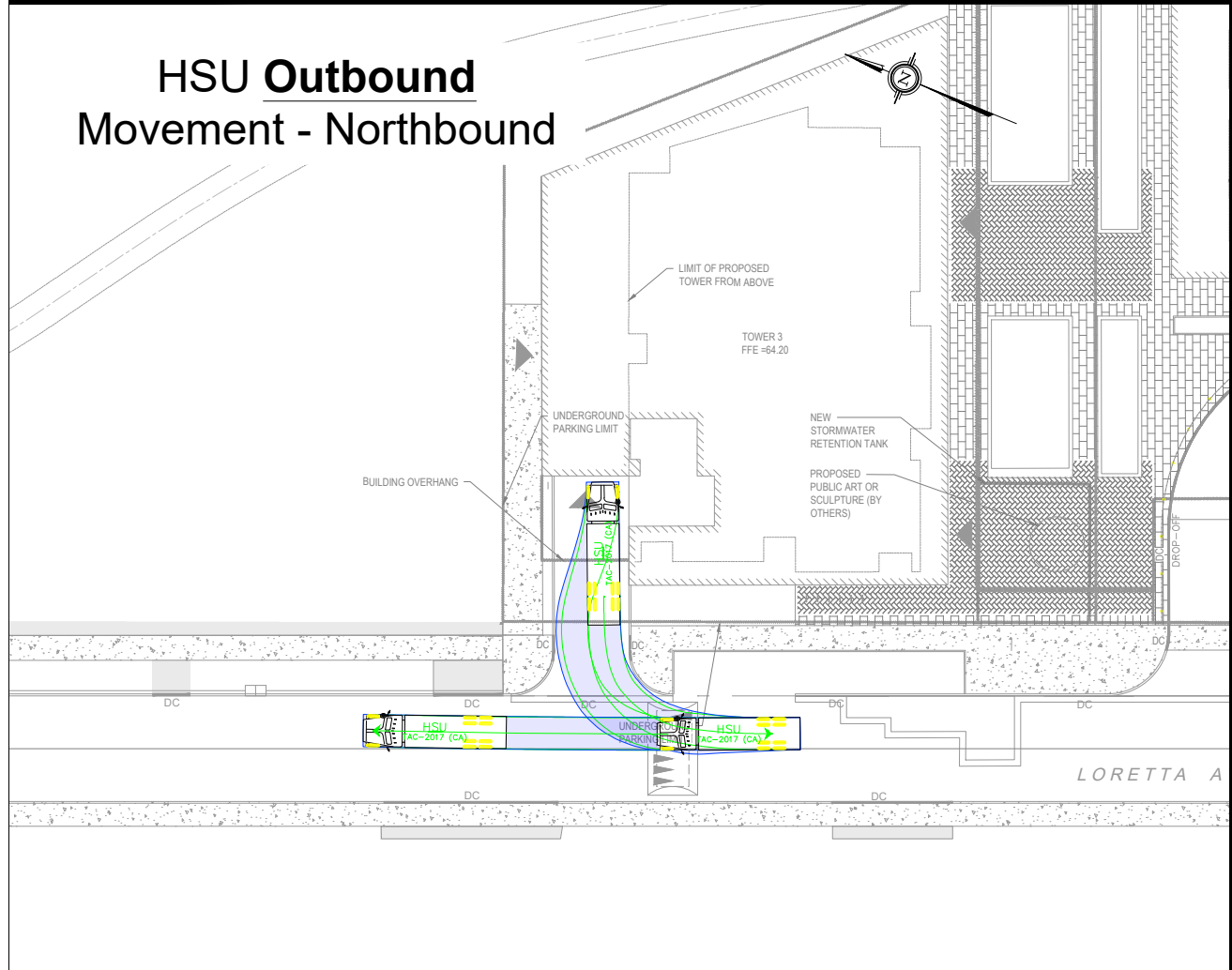

HSU Outbound Movement - Southbound

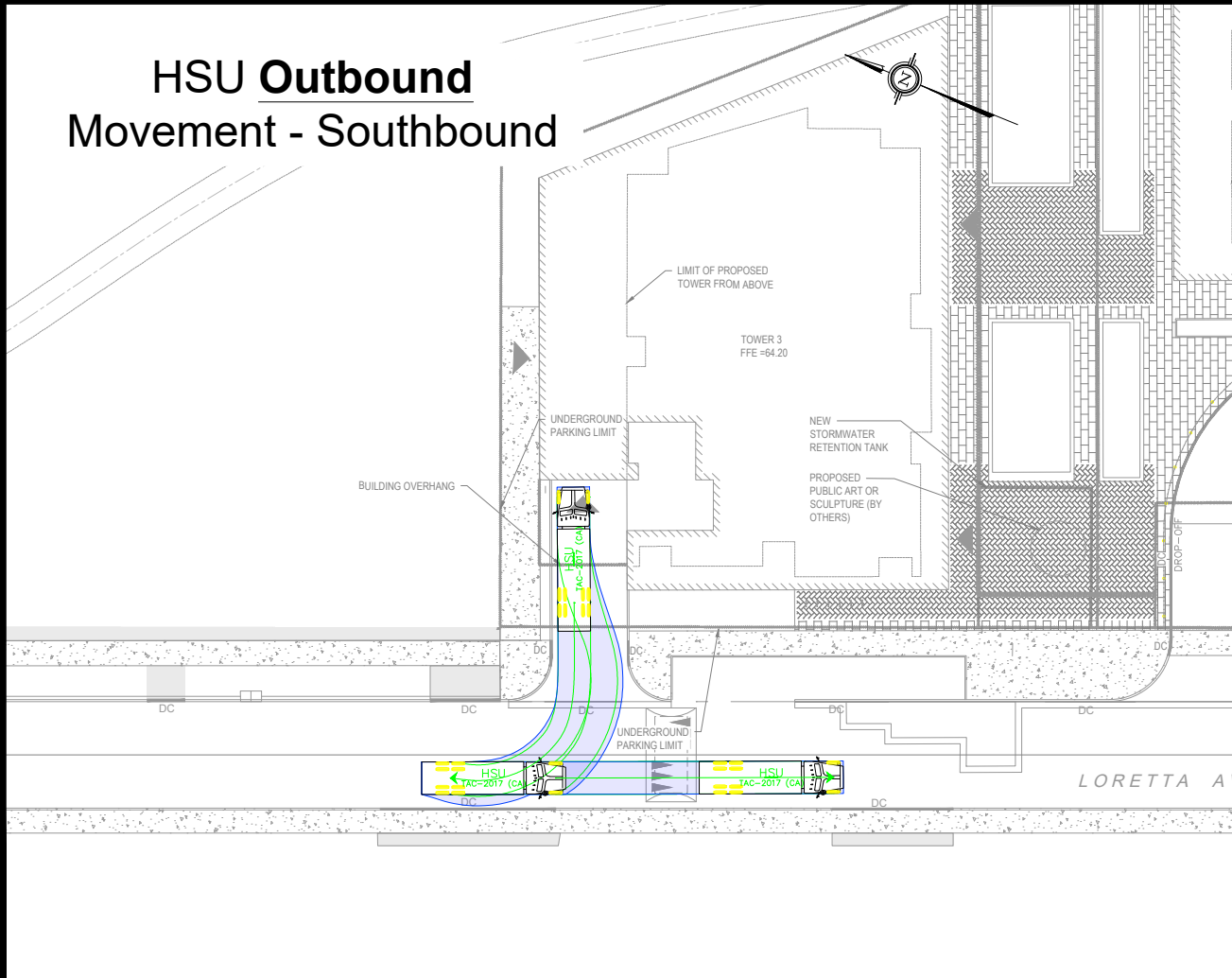

Notes:

Key Plan:

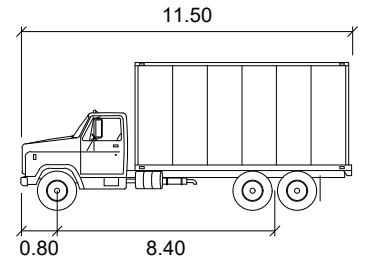
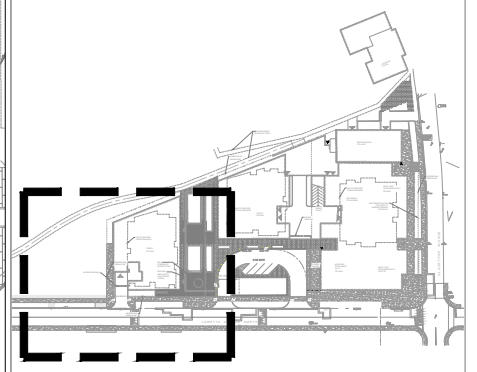

HSU

	units
Width	: 2.60 meters
Track	: 2.60
Lock to Lock Time	: 6.0
Steering Angle	: 40.0

01	Issued for Review:	AN	2024-05-16
REV:	DESCRIPTION:	BY:	DATE:
STATUS:			

CGH Transportation
 6 Plaza Court
 Ottawa, ON
 K2H 7W1
 (343) 999-9117

CLIENT: Trinity Development Group Inc.
 ARCHITECT:

SITE: 951 Gladstone & 145 Loretta
 TITLE: HSU Turning Movements North Access

SCALE AT A3:	DATE:	DRAWN:	CHECKED:
NTS	2024-05-16	AN	AH
PROJECT NO:	DRAWING NO:	REVISION:	
2020-25	001	01	

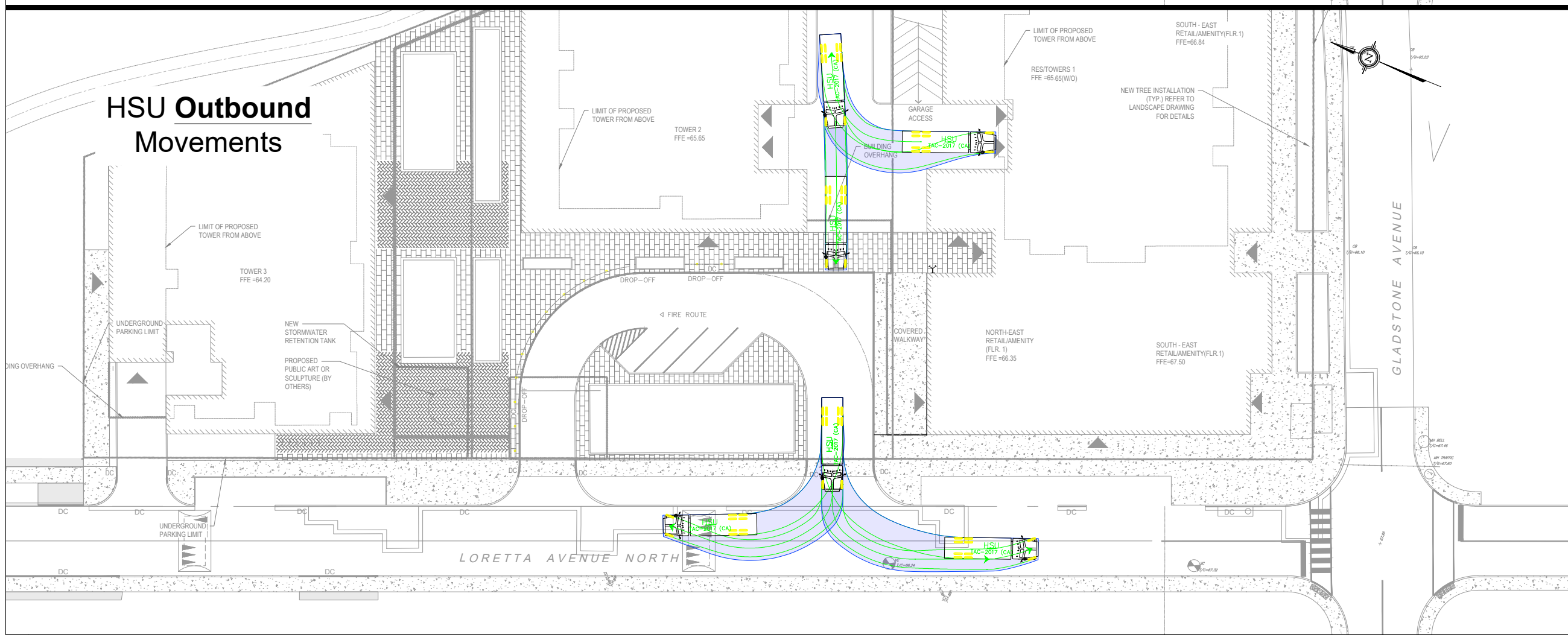
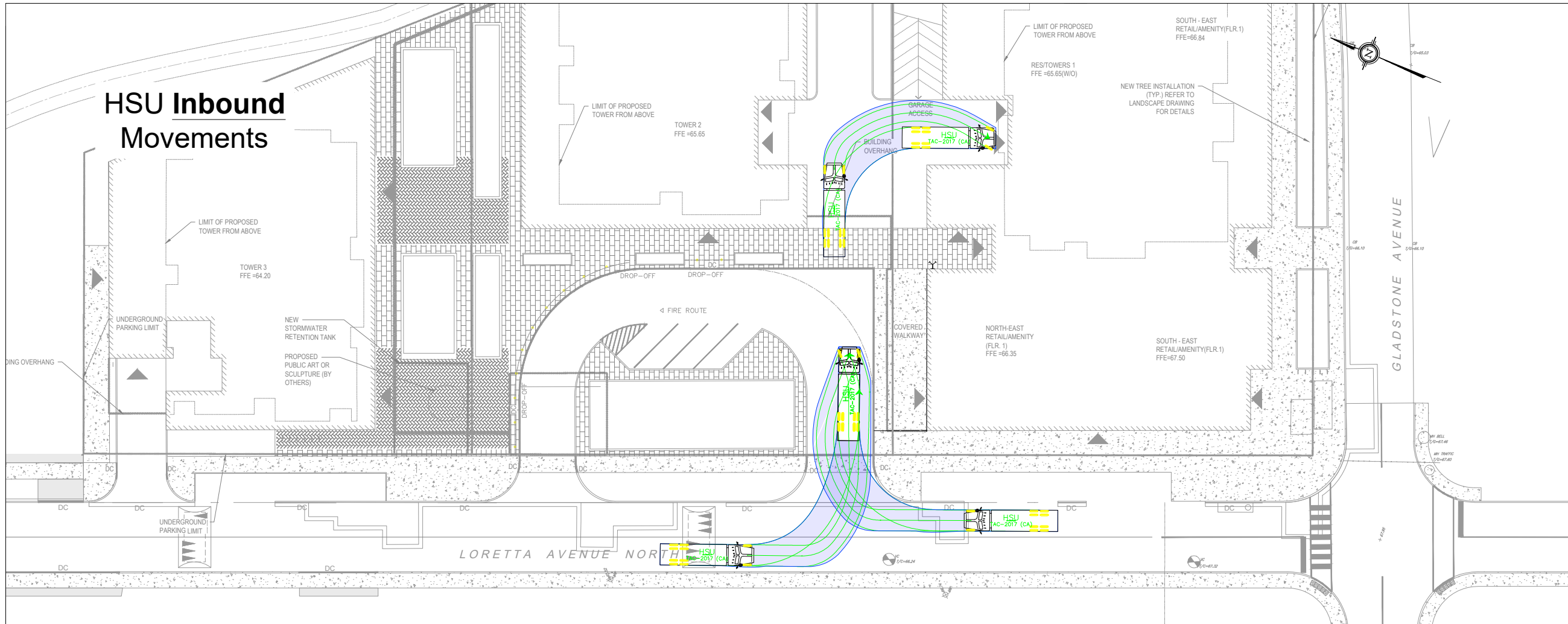

Notes:

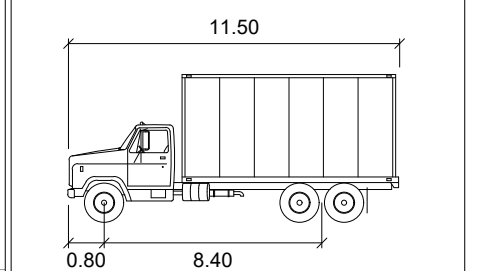
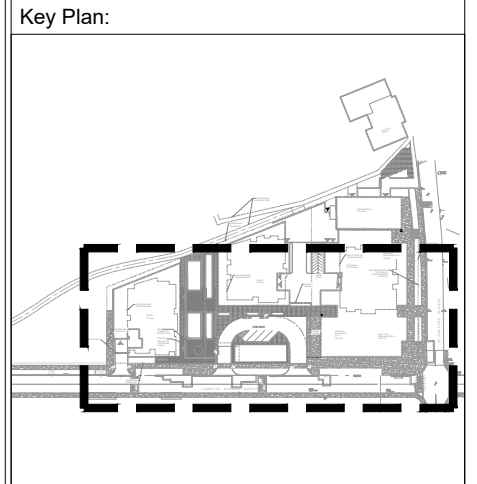

HSU

	units
Width	: 2.60
Track	: 2.60
Lock to Lock Time	: 6.0
Steering Angle	: 40.0

01	Issued for Review:	AN	2024-05-16
REV:	DESCRIPTION:	BY:	DATE:
STATUS:			

CGH Transportation
6 Plaza Court
Ottawa, ON
K2H 7W1
(343) 999-9117

CLIENT: Trinity Development Group Inc.

ARCHITECT:

SITE: 951 Gladstone & 145 Loretta

TITLE: HSU Turning Movements South Access

SCALE AT A3:	DATE:	DRAWN:	CHECKED:
NTS	2024-05-16	AN	AH
PROJECT NO:	DRAWING NO:	REVISION:	
2020-25	002	01	

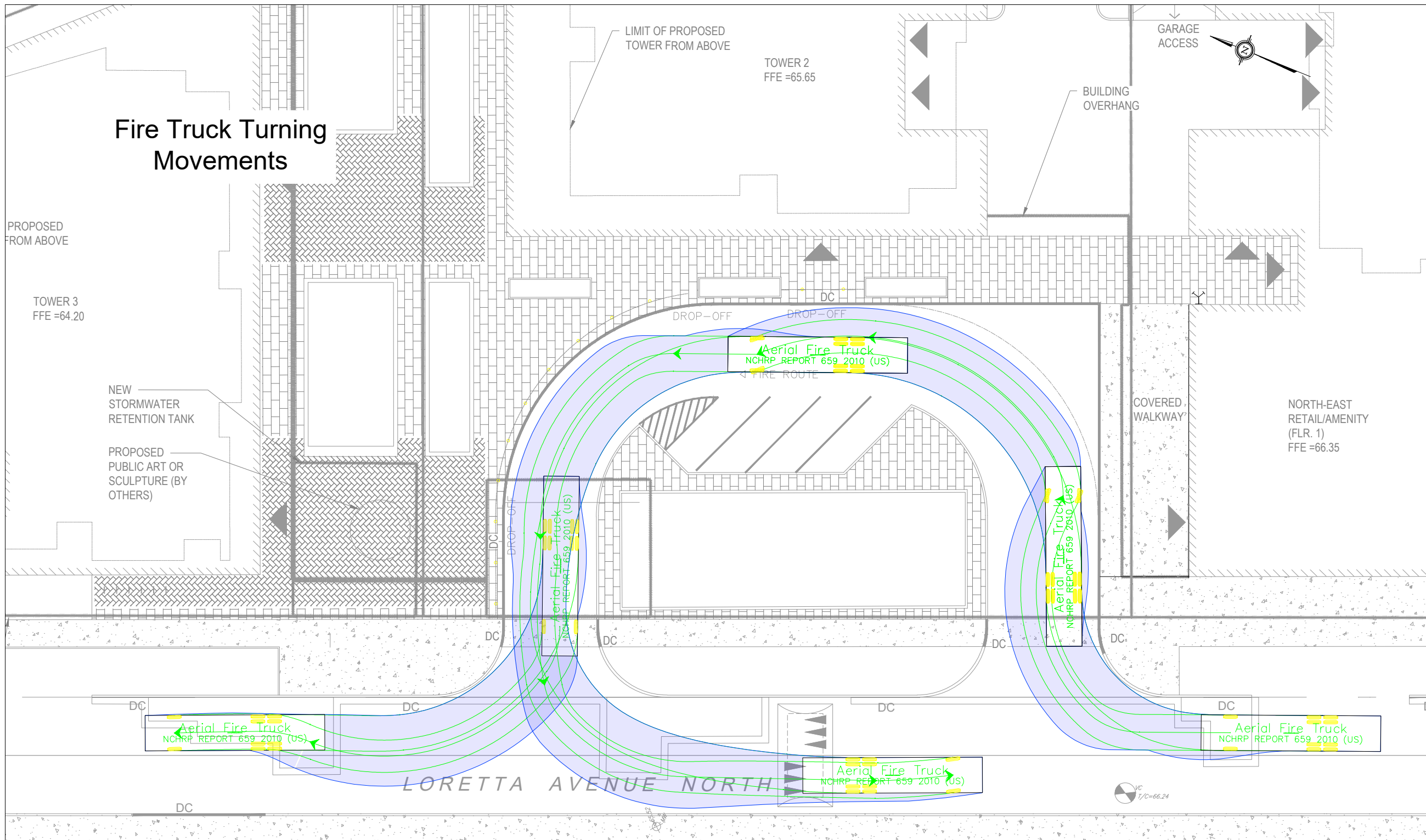

Fire Truck Turning Movements

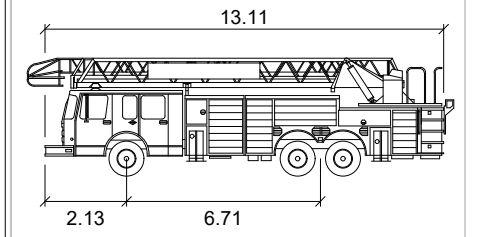
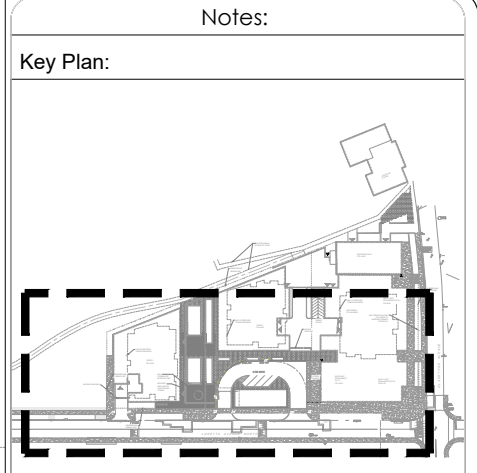

Aerial Fire Truck

	units
Width	: 2.59
Track	: 2.59
Lock to Lock Time	: 6.0
Steering Angle	: 33.3

01	Issued for Review:	AN	2024-05-16
REV:	DESCRIPTION:	BY:	DATE:
STATUS:			

CGH Transportation
 6 Plaza Court
 Ottawa, ON
 K2H 7W1
 (343) 999-9117

CLIENT: Trinity Development Group Inc.

ARCHITECT:

SITE: 951 Gladstone & 145 Loretta

TITLE: Turning Movement Analysis
 Fire Turning Movements

SCALE AT A3: NTS	DATE: 2024-05-16	DRAWN: AN	CHECKED: AH
PROJECT NO: 2020-25	DRAWING NO: 003	REVISION: 01	

Appendix G

MMLOS Analysis

Multi-Modal Level of Service - Intersections Form

Consultant
Scenario
Comments

CGH Transportation Inc
Existing and Future

Project
Date

2020-25
12/20/2021

INTERSECTIONS		Gladstone @ Bayswater				Gladstone @ Preston			
Crossing Side		NORTH	SOUTH	EAST	WEST	NORTH	SOUTH	EAST	WEST
Pedestrian	Lanes	4	3	3	3	4	4	5	0 - 2
	Median	No Median - 2.4 m	No Median - 2.4 m	No Median - 2.4 m	No Median - 2.4 m	No Median - 2.4 m	No Median - 2.4 m	No Median - 2.4 m	No Median - 2.4 m
	Conflicting Left Turns	Permissive	Permissive	Permissive	Permissive	Permissive	Permissive	Permissive	Permissive
	Conflicting Right Turns	Permissive or yield control	Permissive or yield control	Permissive or yield control	Permissive or yield control	Permissive or yield control	Permissive or yield control	Permissive or yield control	Permissive or yield control
	Right Turns on Red (RTor) ?	RTOR allowed	RTOR allowed	RTOR allowed	RTOR allowed	RTOR allowed	RTOR prohibited	RTOR prohibited	RTOR allowed
	Ped Signal Leading Interval?	No	No	No	No	no	no	no	No
	Right Turn Channel	No Channel	No Channel	No Channel	No Channel	No Channel	No Channel	No Channel	No Channel
	Corner Radius	5-10m	5-10m	5-10m	5-10m	5-10m	5-10m	10-15m	5-10m
	Crosswalk Type	Std transverse markings	Std transverse markings	Zebra stripe hi-vis markings	Zebra stripe hi-vis markings	Textured/coloured pavement	Textured/coloured pavement	Textured/coloured pavement	Textured/coloured pavement
	PETSI Score	54	71	74	74	57	60	43	89
	Ped. Exposure to Traffic LoS	D	C	C	C	D	C	E	B
	Cycle Length	60	60	60	60	70	70	70	70
Effective Walk Time	22	22	11	11	28	28	11	11	
Average Pedestrian Delay	12	12	20	20	13	13	25	25	
Pedestrian Delay LoS	B	B	C	C	B	B	C	C	
Level of Service	D	C	C	C	D	C	E	C	
		D				E			
Approach From		NORTH	SOUTH	EAST	WEST	NORTH	SOUTH	EAST	WEST
Bicycle	Bicycle Lane Arrangement on Approach	Mixed Traffic	Mixed Traffic	Mixed Traffic	Mixed Traffic	Mixed Traffic	Mixed Traffic	Mixed Traffic	Mixed Traffic
	Right Turn Lane Configuration								
	Right Turning Speed								
	Cyclist relative to RT motorists	#N/A	#N/A	#N/A	#N/A	#N/A	#N/A	#N/A	#N/A
	Separated or Mixed Traffic	Mixed Traffic	Mixed Traffic	Mixed Traffic	Mixed Traffic	Mixed Traffic	Mixed Traffic	Mixed Traffic	Mixed Traffic
	Left Turn Approach	No lane crossed	No lane crossed	No lane crossed	No lane crossed	One lane crossed	One lane crossed	One lane crossed	No lane crossed
	Operating Speed	≤ 40 km/h	≤ 40 km/h	> 40 to ≤ 50 km/h	> 40 to ≤ 50 km/h	> 40 to ≤ 50 km/h	> 40 to ≤ 50 km/h	> 40 to ≤ 50 km/h	> 40 to ≤ 50 km/h
Left Turning Cyclist	B	B	B	B	D	D	D	B	
Level of Service	#N/A	#N/A	#N/A	#N/A	#N/A	#N/A	#N/A	#N/A	
		#N/A				#N/A			
Transit	Average Signal Delay			≤ 30 sec	≤ 20 sec	≤ 20 sec	≤ 20 sec	≤ 40 sec	≤ 40 sec
	Level of Service	-	-	D	C	C	C	E	E
		D				E			
Truck	Effective Corner Radius					10 - 15 m	10 - 15 m	10 - 15 m	
	Number of Receiving Lanes on Departure from Intersection					1	1	1	
	Level of Service	-	-	-	-	E	E	E	-
		-				E			
Auto	Volume to Capacity Ratio		0.71 - 0.80				0.71 - 0.80		
	Level of Service	C				C			

Multi-Modal Level of Service - Segments Form

Consultant
Scenario
Comments

CGH Transportation Inc
Existing and Future

Project
Date

2020-25
4/7/2021

SEGMENTS			Gladstone	Loretta (frontage)	Loretta (frontage)
			1	2	3
Pedestrian	Sidewalk Width	C	≥ 2 m	no sidewalk	≥ 2 m
	Boulevard Width		< 0.5	n/a	0.5 - 2 m
	Avg Daily Curb Lane Traffic Volume		> 3000	≤ 3000	≤ 3000
	Operating Speed		> 30 to 50 km/h	> 30 to 50 km/h	> 30 to 50 km/h
	On-Street Parking		no	yes	no
	Exposure to Traffic PLoS		C	F	A
	Effective Sidewalk Width		2.0 m		
	Pedestrian Volume		500 ped /hr		
Crowding PLoS	B	-	-		
Level of Service	C	-	-		
Bicycle	Type of Cycling Facility	D	Mixed Traffic	Mixed Traffic	Mixed Traffic
	Number of Travel Lanes		2-3 lanes total	≤ 2 (no centreline)	≤ 2 (no centreline)
	Operating Speed		>40 to <50 km/h	>40 to <50 km/h	>40 to <50 km/h
	# of Lanes & Operating Speed LoS		D	B	B
	Bike Lane (+ Parking Lane) Width				
	Bike Lane Width LoS		-	-	-
	Bike Lane Blockages				
	Blockage LoS		-	-	-
	Median Refuge Width (no median = < 1.8 m)		< 1.8 m refuge	< 1.8 m refuge	< 1.8 m refuge
	No. of Lanes at Unsignalized Crossing		≤ 3 lanes	≤ 3 lanes	≤ 3 lanes
	Sidestreet Operating Speed		>40 to 50 km/h	≤ 40 km/h	≤ 40 km/h
Unsignalized Crossing - Lowest LoS	B	A	A		
Level of Service	D	B	B		
Transit	Facility Type	D	Mixed Traffic		
	Friction or Ratio Transit:Posted Speed		Vt/Vp ≥ 0.8		
	Level of Service		D	-	-
Truck	Truck Lane Width	-			
	Travel Lanes per Direction				
Level of Service	-	-	-	-	
Auto	Level of Service	Not Applicable			

Appendix H

Synchro Intersection Worksheets – Future Total Conditions

HCM 2010 TWSC
1: Breezhill & Gladstone

951 Gladstone & 145 Loretta
Future Total- AM Peak Hour

Intersection												
Int Delay, s/veh	1.4											
Movement	EBL	EBT	EBR	WBL	WBT	WBR	NBL	NBT	NBR	SBL	SBT	SBR
Lane Configurations	↔		↔		↔		↔		↔		↔	
Traffic Vol, veh/h	23	268	0	1	148	41	2	1	5	17	0	23
Future Vol, veh/h	23	268	0	1	148	41	2	1	5	17	0	23
Conflicting Peds, #/hr	25	0	25	25	0	25	8	0	2	2	0	8
Sign Control	Free	Free	Free	Free	Free	Free	Stop	Stop	Stop	Stop	Stop	Stop
RT Channelized	-	-	None	-	-	None	-	-	None	-	-	None
Storage Length	-	-	-	-	-	-	-	-	-	-	-	-
Veh in Median Storage, #	-	0	-	-	0	-	-	0	-	-	0	-
Grade, %	-	0	-	-	0	-	-	0	-	-	0	-
Peak Hour Factor	100	100	100	100	100	100	100	100	100	100	100	100
Heavy Vehicles, %	2	2	2	2	2	2	2	2	2	2	2	2
Mvmt Flow	23	268	0	1	148	41	2	1	5	17	0	23

Major/Minor	Major1	Major2	Minor1	Minor2
Conflicting Flow All	214	0	293	0
Stage 1	-	-	339	339
Stage 2	-	-	190	216
Critical Hdwy	4.12	-	4.12	-
Critical Hdwy Stg 1	-	-	6.12	5.52
Critical Hdwy Stg 2	-	-	6.12	5.52
Follow-up Hdwy	2.218	-	2.218	-
Pot Cap-1 Maneuver	1356	-	1269	-
Stage 1	-	-	676	640
Stage 2	-	-	812	724
Platoon blocked, %	-	-	-	-
Mov Cap-1 Maneuver	1330	-	1244	-
Mov Cap-2 Maneuver	-	-	429	414
Stage 1	-	-	650	615
Stage 2	-	-	783	710

Approach	EB	WB	NB	SB
HCM Control Delay, s	0.6	0	11.4	11.4
HCM LOS			B	B

Minor Lane/Major Mvmt	NBLn1	EBL	EBT	EBR	WBL	WBT	WBR	SBLn1
Capacity (veh/h)	574	1330	-	-	1244	-	-	606
HCM Lane V/C Ratio	0.014	0.017	-	-	0.001	-	-	0.066
HCM Control Delay (s)	11.4	7.8	0	-	7.9	0	-	11.4
HCM Lane LOS	B	A	A	-	A	A	-	B
HCM 95th %tile Q(veh)	0	0.1	-	-	0	-	-	0.2

Lanes, Volumes, Timings
2: Preston & Gladstone

951 Gladstone & 145 Loretta
Future Total- AM Peak Hour



Lane Group	EBL	EBT	EBR	WBL	WBT	WBR	NBL	NBT	NBR	SBL	SBT	SBR
Lane Configurations		↔		↔	↔		↔	↔		↔	↔	
Traffic Volume (vph)	29	177	64	47	169	64	63	395	84	75	368	27
Future Volume (vph)	29	177	64	47	169	64	63	395	84	75	368	27
Satd. Flow (prot)	0	1596	0	1658	1590	0	1658	1643	0	1658	1715	0
Fit Permitted		0.938		0.507			0.494			0.427		
Satd. Flow (perm)	0	1490	0	815	1590	0	826	1643	0	690	1715	0
Satd. Flow (RTOR)					26			25				
Lane Group Flow (vph)	0	270	0	47	233	0	63	479	0	75	395	0
Turn Type	Perm	NA		Perm	NA		Perm	NA		Perm	NA	
Protected Phases		4			8			2			6	
Permitted Phases	4				8			2			6	
Detector Phase	4	4			8	8		2	2		6	6
Switch Phase												
Minimum Initial (s)	10.0	10.0		10.0	10.0		10.0	10.0		10.0	10.0	
Minimum Split (s)	24.5	24.5		24.5	24.5		23.7	23.7		23.7	23.7	
Total Split (s)	25.0	25.0		25.0	25.0		45.0	45.0		45.0	45.0	
Total Split (%)	35.7%	35.7%		35.7%	35.7%		64.3%	64.3%		64.3%	64.3%	
Yellow Time (s)	3.0	3.0		3.0	3.0		3.3	3.3		3.3	3.3	
All-Red Time (s)	3.5	3.5		3.5	3.5		2.4	2.4		2.4	2.4	
Lost Time Adjust (s)		0.0		0.0	0.0		0.0	0.0		0.0	0.0	
Total Lost Time (s)		6.5		6.5	6.5		5.7	5.7		5.7	5.7	
Lead/Lag												
Lead-Lag Optimize?												
Recall Mode	None	None		None	None		C-Min	C-Min		C-Min	C-Min	
Act Effct Green (s)		17.6		17.6	17.6		40.2	40.2		40.2	40.2	
Actuated g/C Ratio		0.25		0.25	0.25		0.57	0.57		0.57	0.57	
v/c Ratio		0.72		0.23	0.56		0.13	0.50		0.19	0.40	
Control Delay		36.6		21.8	24.5		9.4	11.8		10.4	10.9	
Queue Delay		0.0		0.0	0.0		0.0	0.0		0.0	0.0	
Total Delay		36.6		21.8	24.5		9.4	11.8		10.4	10.9	
LOS		D		C	C		A	B		B	B	
Approach Delay		36.6			24.1			11.5			10.8	
Approach LOS		D			C			B			B	
Queue Length 50th (m)		39.7		4.9	23.3		3.5	32.3		4.3	26.1	
Queue Length 95th (m)		27.1		11.5	38.5		10.6	66.0		12.8	52.5	
Internal Link Dist (m)		140.4			149.8			122.5			139.6	
Turn Bay Length (m)					37.5			24.0			28.0	
Base Capacity (vph)		422		231	469		489	985		409	1017	
Starvation Cap Reductn		0		0	0		0	0		0	0	
Spillback Cap Reductn		0		0	0		0	0		0	0	
Storage Cap Reductn		0		0	0		0	0		0	0	
Reduced v/c Ratio		0.64		0.20	0.50		0.13	0.49		0.18	0.39	

Intersection Summary	
Cycle Length: 70	
Actuated Cycle Length: 70	
Offset: 37 (53%), Referenced to phase 2:NBTL and 6:SBTL, Start of Green	
Natural Cycle: 55	
Control Type: Actuated-Coordinated	

Lanes, Volumes, Timings
2: Preston & Gladstone

951 Gladstone & 145 Loretta
Future Total- AM Peak Hour

Maximum v/c Ratio: 0.72	Intersection LOS: B
Intersection Signal Delay: 17.9	ICU Level of Service E
Intersection Capacity Utilization 88.4%	
Analysis Period (min) 15	

Splits and Phases: 2: Preston & Gladstone

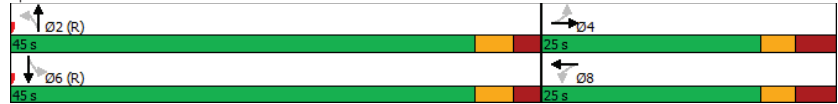

HCM 2010 TWSC
3: Breezehill & Somerset

951 Gladstone & 145 Loretta
Future Total- AM Peak Hour

Intersection						
Int Delay, s/veh	1.1					
Movement	EBT	EBR	WBL	WBT	NBL	NBR
Lane Configurations	↔		↔		↔	
Traffic Vol, veh/h	260	32	16	254	19	23
Future Vol, veh/h	260	32	16	254	19	23
Conflicting Peds, #/hr	0	50	50	0	0	0
Sign Control	Free	Free	Free	Free	Stop	Stop
RT Channelized	-	None	-	None	-	None
Storage Length	-	-	-	-	0	-
Veh in Median Storage, #	0	-	-	0	0	-
Grade, %	0	-	-	0	0	-
Peak Hour Factor	100	100	100	100	100	100
Heavy Vehicles, %	2	2	2	2	2	2
Mvmt Flow	260	32	16	254	19	23

Major/Minor	Major1	Major2	Minor1
Conflicting Flow All	0	0	342
Stage 1	-	-	326
Stage 2	-	-	286
Critical Hdwy	-	-	4.12
Critical Hdwy Stg 1	-	-	5.42
Critical Hdwy Stg 2	-	-	5.42
Follow-up Hdwy	-	-	2.218
Pot Cap-1 Maneuver	-	-	1217
Stage 1	-	-	731
Stage 2	-	-	763
Platoon blocked, %	-	-	-
Mov Cap-1 Maneuver	-	-	1170
Mov Cap-2 Maneuver	-	-	431
Stage 1	-	-	702
Stage 2	-	-	751

Approach	EB	WB	NB
HCM Control Delay, s	0	0.5	12.2
HCM LOS			B

Minor Lane/Major Mvmt	NBLn1	EBT	EBR	WBL	WBT
Capacity (veh/h)	541	-	-	1170	-
HCM Lane V/C Ratio	0.078	-	-	0.014	-
HCM Control Delay (s)	12.2	-	-	8.1	0
HCM Lane LOS	B	-	-	A	A
HCM 95th %tile Q(veh)	0.3	-	-	0	-

HCM 2010 TWSC
6: Loretta & Gladstone

951 Gladstone & 145 Loretta
Future Total- AM Peak Hour

Intersection												
Int Delay, s/veh	2.9											
Movement	EBL	EBT	EBR	WBL	WBT	WBR	NBL	NBT	NBR	SBL	SBT	SBR
Lane Configurations	↕			↕			↕			↕		
Traffic Vol, veh/h	66	209	15	19	154	73	8	0	7	38	3	28
Future Vol, veh/h	66	209	15	19	154	73	8	0	7	38	3	28
Conflicting Peds, #/hr	25	0	14	14	0	25	3	0	3	3	0	3
Sign Control	Free	Free	Free	Free	Free	Free	Stop	Stop	Stop	Stop	Stop	Stop
RT Channelized	-	-	None	-	-	None	-	-	None	-	-	None
Storage Length	-	-	-	-	-	-	-	-	-	-	-	-
Veh in Median Storage, #	-	0	-	-	0	-	-	0	-	-	0	-
Grade, %	-	0	-	-	0	-	-	0	-	-	0	-
Peak Hour Factor	100	100	100	100	100	100	100	100	100	100	100	100
Heavy Vehicles, %	2	2	2	2	2	2	2	2	2	2	2	2
Mvmt Flow	66	209	15	19	154	73	8	0	7	38	3	28
Major/Minor	Major1	Major2	Minor1	Minor2								
Conflicting Flow All	252	0	0	238	0	0	610	653	234	609	624	219
Stage 1	-	-	-	-	-	-	363	363	-	254	254	-
Stage 2	-	-	-	-	-	-	247	290	-	355	370	-
Critical Hdwy	4.12	-	-	4.12	-	-	7.12	6.52	6.22	7.12	6.52	6.22
Critical Hdwy Stg 1	-	-	-	-	-	-	6.12	5.52	-	6.12	5.52	-
Critical Hdwy Stg 2	-	-	-	-	-	-	6.12	5.52	-	6.12	5.52	-
Follow-up Hdwy	2.218	-	-	2.218	-	-	3.518	4.018	3.318	3.518	4.018	3.318
Pot Cap-1 Maneuver	1313	-	-	1329	-	-	407	387	805	407	402	821
Stage 1	-	-	-	-	-	-	656	625	-	750	697	-
Stage 2	-	-	-	-	-	-	757	672	-	662	620	-
Platoon blocked, %	-	-	-	-	-	-	-	-	-	-	-	-
Mov Cap-1 Maneuver	1288	-	-	1315	-	-	363	347	794	372	361	803
Mov Cap-2 Maneuver	-	-	-	-	-	-	363	347	-	372	361	-
Stage 1	-	-	-	-	-	-	611	582	-	692	672	-
Stage 2	-	-	-	-	-	-	713	648	-	616	577	-
Approach	EB	WB	NB	SB								
HCM Control Delay, s	1.8	0.6	12.6	13.9								
HCM LOS			B	B								
Minor Lane/Major Mvmt	NBLn1	EBL	EBT	EBR	WBL	WBT	WBR	SBLn1				
Capacity (veh/h)	486	1288	-	-	1315	-	-	475				
HCM Lane V/C Ratio	0.031	0.051	-	-	0.014	-	-	0.145				
HCM Control Delay (s)	12.6	7.9	0	-	7.8	0	-	13.9				
HCM Lane LOS	B	A	A	-	A	A	-	B				
HCM 95th %tile Q(veh)	0.1	0.2	-	-	0	-	-	0.5				

HCM 2010 AWSC
7: Breezehill & Laurel

951 Gladstone & 145 Loretta
Future Total- AM Peak Hour

Intersection												
Intersection Delay, s/veh	7.5											
Intersection LOS	A											
Movement	EBL	EBT	EBR	WBL	WBT	WBR	NBL	NBT	NBR	SBL	SBT	SBR
Lane Configurations	↕			↕			↕			↕		
Traffic Vol, veh/h	11	31	10	6	10	10	11	49	10	32	31	16
Future Vol, veh/h	11	31	10	6	10	10	11	49	10	32	31	16
Peak Hour Factor	1.00	1.00	1.00	1.00	1.00	1.00	1.00	1.00	1.00	1.00	1.00	1.00
Heavy Vehicles, %	2	2	2	2	2	2	2	2	2	2	2	2
Mvmt Flow	11	31	10	6	10	10	11	49	10	32	31	16
Number of Lanes	0	1	0	0	1	0	0	1	0	0	1	0
Approach	EB	WB	NB	SB								
Opposing Approach	WB	EB	SB	NB								
Opposing Lanes	1	1	1	1								
Conflicting Approach Left	SB	NB	EB	WB								
Conflicting Lanes Left	1	1	1	1								
Conflicting Approach Right	NB	SB	WB	EB								
Conflicting Lanes Right	1	1	1	1								
HCM Control Delay	7.5	7.3	7.5	7.5								
HCM LOS	A	A	A	A								
Lane	NBLn1	EBLn1	WBLn1	SBLn1								
Vol Left, %	16%	21%	23%	41%								
Vol Thru, %	70%	60%	38%	39%								
Vol Right, %	14%	19%	38%	20%								
Sign Control	Stop	Stop	Stop	Stop								
Traffic Vol by Lane	70	52	26	79								
LT Vol	11	11	6	32								
Through Vol	49	31	10	31								
RT Vol	10	10	10	16								
Lane Flow Rate	70	52	26	79								
Geometry Grp	1	1	1	1								
Degree of Util (X)	0.079	0.06	0.029	0.09								
Departure Headway (Hd)	4.075	4.137	4.046	4.082								
Convergence, Y/N	Yes	Yes	Yes	Yes								
Cap	872	855	872	871								
Service Time	2.131	2.214	2.13	2.136								
HCM Lane V/C Ratio	0.08	0.061	0.03	0.091								
HCM Control Delay	7.5	7.5	7.3	7.5								
HCM Lane LOS	A	A	A	A								
HCM 95th %tile Q	0.3	0.2	0.1	0.3								

Lanes, Volumes, Timings
8: Bayswater & Gladstone

951 Gladstone & 145 Loretta
Future Total- AM Peak Hour

Lane Group	EBL	EBT	EBR	WBL	WBT	WBR	NBL	NBT	NBR	SBL	SBT	SBR
Lane Configurations		↔			↔			↔				↔
Traffic Volume (vph)	23	219	16	14	124	35	19	106	22	50	124	37
Future Volume (vph)	23	219	16	14	124	35	19	106	22	50	124	37
Satd. Flow (prot)	0	1713	0	0	1666	0	0	1687	0	0	1673	0
Fit Permitted		0.968			0.970			0.950			0.902	
Satd. Flow (perm)	0	1661	0	0	1620	0	0	1612	0	0	1522	0
Satd. Flow (RTOR)		7			28			17			20	
Lane Group Flow (vph)	0	258	0	0	173	0	0	147	0	0	211	0
Turn Type	Perm	NA		Perm	NA		Perm	NA		Perm	NA	
Protected Phases		2			6			8			4	
Permitted Phases	2			6			8			4		
Detector Phase	2	2		6	6		8	8		4	4	
Switch Phase												
Minimum Initial (s)	10.0	10.0		10.0	10.0		10.0	10.0		10.0	10.0	
Minimum Split (s)	22.5	22.5		22.5	22.5		22.5	22.5		22.5	22.5	
Total Split (s)	33.0	33.0		33.0	33.0		27.0	27.0		27.0	27.0	
Total Split (%)	55.0%	55.0%		55.0%	55.0%		45.0%	45.0%		45.0%	45.0%	
Yellow Time (s)	3.0	3.0		3.0	3.0		3.3	3.3		3.3	3.3	
All-Red Time (s)	2.5	2.5		2.5	2.5		2.0	2.0		2.0	2.0	
Lost Time Adjust (s)		0.0			0.0			0.0			0.0	
Total Lost Time (s)		5.5			5.5			5.3			5.3	
Lead/Lag												
Lead-Lag Optimize?												
Recall Mode	C-Max	C-Max		C-Max	C-Max		Max	Max		Max	Max	
Act Effct Green (s)		27.5			27.5			21.7			21.7	
Actuated g/C Ratio		0.46			0.46			0.36			0.36	
v/c Ratio		0.34			0.23			0.25			0.37	
Control Delay		11.7			9.2			13.2			15.1	
Queue Delay		0.0			0.0			0.0			0.0	
Total Delay		11.7			9.2			13.2			15.1	
LOS		B			A			B			B	
Approach Delay		11.7			9.2			13.2			15.1	
Approach LOS		B			A			B			B	
Queue Length 50th (m)		16.6			8.9			9.7			14.9	
Queue Length 95th (m)		30.6			18.9			20.6			29.6	
Internal Link Dist (m)		95.1			81.5			119.0			98.4	
Turn Bay Length (m)												
Base Capacity (vph)		765			757			593			563	
Starvation Cap Reductn		0			0			0			0	
Spillback Cap Reductn		0			0			0			0	
Storage Cap Reductn		0			0			0			0	
Reduced v/c Ratio		0.34			0.23			0.25			0.37	

Intersection Summary

Cycle Length: 60
Actuated Cycle Length: 60
Offset: 29 (48%), Referenced to phase 2:EBTL and 6:WBTL, Start of Green
Natural Cycle: 45
Control Type: Actuated-Coordinated

Lanes, Volumes, Timings
8: Bayswater & Gladstone

951 Gladstone & 145 Loretta
Future Total- AM Peak Hour

Maximum v/c Ratio: 0.37	Intersection LOS: B
Intersection Signal Delay: 12.3	ICU Level of Service A
Intersection Capacity Utilization 49.4%	
Analysis Period (min) 15	

Splits and Phases: 8: Bayswater & Gladstone

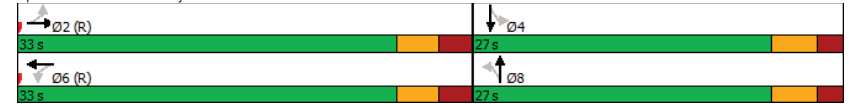

Lanes, Volumes, Timings
9: Gladstone

951 Gladstone & 145 Loretta
Future Total- AM Peak Hour

Lane Group	EBL	EBT	EBR	WBL	WBT	WBR	NBL	NBT	NBR	SBL	SBT	SBR
Lane Configurations		↑			↑							
Traffic Volume (vph)	0	254	0	0	246	0	0	0	0	0	0	0
Future Volume (vph)	0	254	0	0	246	0	0	0	0	0	0	0
Satd. Flow (prot)	0	1745	0	0	1745	0	0	0	0	0	0	0
Fit Permitted												
Satd. Flow (perm)	0	1745	0	0	1745	0	0	0	0	0	0	0
Satd. Flow (RTOR)												
Lane Group Flow (vph)	0	254	0	0	246	0	0	0	0	0	0	0
Turn Type		NA			NA							
Protected Phases		2			6							
Permitted Phases												
Detector Phase		2			6							
Switch Phase												
Minimum Initial (s)		10.0			10.0							
Minimum Split (s)		22.5			22.5							
Total Split (s)		50.0			50.0							
Total Split (%)		71.4%			71.4%							
Yellow Time (s)		3.0			3.0							
All-Red Time (s)		1.9			1.9							
Lost Time Adjust (s)		0.0			0.0							
Total Lost Time (s)		4.9			4.9							
Lead/Lag												
Lead-Lag Optimize?												
Recall Mode		C-Max			C-Max							
Act Effct Green (s)		56.8			56.8							
Actuated g/C Ratio		0.81			0.81							
v/c Ratio		0.18			0.17							
Control Delay		3.5			2.1							
Queue Delay		0.0			0.0							
Total Delay		3.5			2.1							
LOS		A			A							
Approach Delay		3.5			2.1							
Approach LOS		A			A							
Queue Length 50th (m)		10.1			3.8							
Queue Length 95th (m)		17.5			13.8							
Internal Link Dist (m)		136.1			140.4			3.1			12.7	
Turn Bay Length (m)												
Base Capacity (vph)		1416			1416							
Starvation Cap Reductn		0			0							
Spillback Cap Reductn		0			0							
Storage Cap Reductn		0			0							
Reduced v/c Ratio		0.18			0.17							
Intersection Summary												
Cycle Length: 70												
Actuated Cycle Length: 70												
Offset: 0 (0%), Referenced to phase 2:EBT and 6:WBT, Start of Green												
Natural Cycle: 45												
Control Type: Actuated-Coordinated												

Lanes, Volumes, Timings
9: Gladstone

951 Gladstone & 145 Loretta
Future Total- AM Peak Hour

Lane Group	Ø4	Ø8
Lane Configurations		
Traffic Volume (vph)		
Future Volume (vph)		
Satd. Flow (prot)		
Fit Permitted		
Satd. Flow (perm)		
Satd. Flow (RTOR)		
Lane Group Flow (vph)		
Turn Type		
Protected Phases	4	8
Permitted Phases		
Detector Phase		
Switch Phase		
Minimum Initial (s)	10.0	10.0
Minimum Split (s)	18.0	18.0
Total Split (s)	20.0	20.0
Total Split (%)	29%	29%
Yellow Time (s)	3.0	3.0
All-Red Time (s)	1.1	1.1
Lost Time Adjust (s)		
Total Lost Time (s)		
Lead/Lag		
Lead-Lag Optimize?		
Recall Mode	None	None
Act Effct Green (s)		
Actuated g/C Ratio		
v/c Ratio		
Control Delay		
Queue Delay		
Total Delay		
LOS		
Approach Delay		
Approach LOS		
Queue Length 50th (m)		
Queue Length 95th (m)		
Internal Link Dist (m)		
Turn Bay Length (m)		
Base Capacity (vph)		
Starvation Cap Reductn		
Spillback Cap Reductn		
Storage Cap Reductn		
Reduced v/c Ratio		
Intersection Summary		

Lanes, Volumes, Timings
9: Gladstone

951 Gladstone & 145 Loretta
Future Total- AM Peak Hour

Maximum v/c Ratio: 0.18	Intersection LOS: A
Intersection Signal Delay: 2.8	ICU Level of Service A
Intersection Capacity Utilization 18.2%	
Analysis Period (min) 15	

Splits and Phases: 9: Gladstone

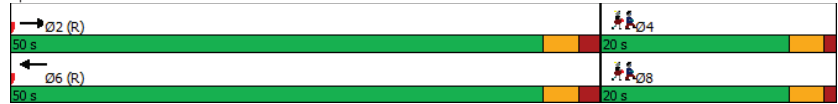

HCM 2010 TWSC
5: Loretta & Access #1

951 Gladstone & 145 Loretta
Future Total- AM Peak Hour

Intersection						
Int Delay, s/veh	1.7					
Movement	WBL	WBR	NBT	NBR	SBL	SBT
Lane Configurations	W	R	T	R	T	R
Traffic Vol, veh/h	26	3	57	82	14	42
Future Vol, veh/h	26	3	57	82	14	42
Conflicting Peds, #/hr	0	0	0	0	0	0
Sign Control	Stop	Stop	Free	Free	Free	Free
RT Channelized	-	None	-	None	-	None
Storage Length	0	-	-	-	-	-
Veh in Median Storage, #	0	-	0	-	-	0
Grade, %	0	-	0	-	-	0
Peak Hour Factor	100	100	100	100	100	100
Heavy Vehicles, %	2	2	2	2	2	2
Mvmt Flow	26	3	57	82	14	42
Major/Minor	Minor1	Major1	Major2			
Conflicting Flow All	168	98	0	0	139	0
Stage 1	98	-	-	-	-	-
Stage 2	70	-	-	-	-	-
Critical Hdwy	6.42	6.22	-	-	4.12	-
Critical Hdwy Stg 1	5.42	-	-	-	-	-
Critical Hdwy Stg 2	5.42	-	-	-	-	-
Follow-up Hdwy	3.518	3.318	-	-	2.218	-
Pot Cap-1 Maneuver	822	958	-	-	1445	-
Stage 1	926	-	-	-	-	-
Stage 2	953	-	-	-	-	-
Platoon blocked, %	-	-	-	-	-	-
Mov Cap-1 Maneuver	814	958	-	-	1445	-
Mov Cap-2 Maneuver	814	-	-	-	-	-
Stage 1	926	-	-	-	-	-
Stage 2	943	-	-	-	-	-
Approach	WB	NB	SB			
HCM Control Delay, s	9.5	0	1.9			
HCM LOS	A					
Minor Lane/Major Mvmt	NBT	NBRWBLn1	SBL	SBT		
Capacity (veh/h)	-	-	827	1445		
HCM Lane V/C Ratio	-	-	0.035	0.01		
HCM Control Delay (s)	-	-	9.5	7.5	0	
HCM Lane LOS	-	-	A	A	A	
HCM 95th %tile Q(veh)	-	-	0.1	0		

HCM 2010 TWSC
4: Loretta & Access #2

951 Gladstone & 145 Loretta
Future Total- AM Peak Hour

Intersection						
Int Delay, s/veh	0.3					
Movement	WBL	WBR	NBT	NBR	SBL	SBT
Lane Configurations	↔		↑			↑
Traffic Vol, veh/h	2	2	60	0	0	54
Future Vol, veh/h	2	2	60	0	0	54
Conflicting Peds, #/hr	0	0	0	0	0	0
Sign Control	Stop	Stop	Free	Free	Free	Free
RT Channelized	-	None	-	None	-	None
Storage Length	0	-	-	-	-	-
Veh in Median Storage, #	0	-	0	-	-	0
Grade, %	0	-	0	-	-	0
Peak Hour Factor	100	100	100	100	100	100
Heavy Vehicles, %	2	2	2	2	2	2
Mvmt Flow	2	2	60	0	0	54

Major/Minor	Minor1	Major1	Major2
Conflicting Flow All	114	60	0
Stage 1	60	-	-
Stage 2	54	-	-
Critical Hdwy	6.42	6.22	-
Critical Hdwy Stg 1	5.42	-	-
Critical Hdwy Stg 2	5.42	-	-
Follow-up Hdwy	3.518	3.318	-
Pot Cap-1 Maneuver	882	1005	0
Stage 1	963	-	0
Stage 2	969	-	0
Platoon blocked, %	-	-	-
Mov Cap-1 Maneuver	882	1005	-
Mov Cap-2 Maneuver	882	-	-
Stage 1	963	-	-
Stage 2	969	-	-

Approach	WB	NB	SB
HCM Control Delay, s	8.9	0	0
HCM LOS	A		

Minor Lane/Major Mvmt	NBTWBLn1	SBT
Capacity (veh/h)	-	939
HCM Lane V/C Ratio	-	0.004
HCM Control Delay (s)	-	8.9
HCM Lane LOS	-	A
HCM 95th %tile Q(veh)	-	0

HCM 2010 TWSC
10: Loretta & Access #3

951 Gladstone & 145 Loretta
Future Total- AM Peak Hour

Intersection						
Int Delay, s/veh	0.6					
Movement	WBL	WBR	NBT	NBR	SBL	SBT
Lane Configurations	↔		↔			↔
Traffic Vol, veh/h	7	1	59	3	1	48
Future Vol, veh/h	7	1	59	3	1	48
Conflicting Peds, #/hr	0	0	0	0	0	0
Sign Control	Stop	Stop	Free	Free	Free	Free
RT Channelized	-	None	-	None	-	None
Storage Length	0	-	-	-	-	-
Veh in Median Storage, #	0	-	0	-	-	0
Grade, %	0	-	0	-	-	0
Peak Hour Factor	100	100	100	100	100	100
Heavy Vehicles, %	2	2	2	2	2	2
Mvmt Flow	7	1	59	3	1	48

Major/Minor	Minor1	Major1	Major2
Conflicting Flow All	111	61	0
Stage 1	61	-	-
Stage 2	50	-	-
Critical Hdwy	6.42	6.22	4.12
Critical Hdwy Stg 1	5.42	-	-
Critical Hdwy Stg 2	5.42	-	-
Follow-up Hdwy	3.518	3.318	2.218
Pot Cap-1 Maneuver	886	1004	1541
Stage 1	962	-	-
Stage 2	972	-	-
Platoon blocked, %	-	-	-
Mov Cap-1 Maneuver	885	1004	1541
Mov Cap-2 Maneuver	885	-	-
Stage 1	962	-	-
Stage 2	971	-	-

Approach	WB	NB	SB
HCM Control Delay, s	9	0	0.1
HCM LOS	A		

Minor Lane/Major Mvmt	NBT	NBRWBLn1	SBL	SBT
Capacity (veh/h)	-	-	898	1541
HCM Lane V/C Ratio	-	-	0.009	0.001
HCM Control Delay (s)	-	-	9	7.3
HCM Lane LOS	-	-	A	A
HCM 95th %tile Q(veh)	-	-	0	0

HCM 2010 TWSC
1: Breezehill & Gladstone

951 Gladstone & 145 Loretta
Future Total - PM Peak Hour

Intersection												
Int Delay, s/veh	1.4											
Movement	EBL	EBT	EBR	WBL	WBT	WBR	NBL	NBT	NBR	SBL	SBT	SBR
Lane Configurations	↔		↔		↔		↔		↔		↔	
Traffic Vol, veh/h	17	216	4	6	659	27	3	0	1	28	0	23
Future Vol, veh/h	17	216	4	6	659	27	3	0	1	28	0	23
Conflicting Peds, #/hr	26	0	25	25	0	26	7	0	10	10	0	7
Sign Control	Free	Free	Free	Free	Free	Free	Stop	Stop	Stop	Stop	Stop	Stop
RT Channelized	-	-	None	-	-	None	-	-	None	-	-	None
Storage Length	-	-	-	-	-	-	-	-	-	-	-	-
Veh in Median Storage, #	-	0	-	-	0	-	-	0	-	-	0	-
Grade, %	-	0	-	-	0	-	-	0	-	-	0	-
Peak Hour Factor	100	100	100	100	100	100	100	100	100	100	100	100
Heavy Vehicles, %	2	2	2	2	2	2	2	2	2	2	2	2
Mvmt Flow	17	216	4	6	659	27	3	0	1	28	0	23
Major/Minor	Major1		Major2		Minor1		Minor2					
Conflicting Flow All	712	0	0	245	0	0	980	1001	253	974	990	706
Stage 1	-	-	-	-	-	-	277	-	711	711	-	-
Stage 2	-	-	-	-	-	-	703	724	-	263	279	-
Critical Hdwy	4.12	-	-	4.12	-	-	7.12	6.52	6.22	7.12	6.52	6.22
Critical Hdwy Stg 1	-	-	-	-	-	-	6.12	5.52	-	6.12	5.52	-
Critical Hdwy Stg 2	-	-	-	-	-	-	6.12	5.52	-	6.12	5.52	-
Follow-up Hdwy	2.218	-	-	2.218	-	-	3.518	4.018	3.318	3.518	4.018	3.318
Pot Cap-1 Maneuver	888	-	-	1321	-	-	229	243	786	231	246	436
Stage 1	-	-	-	-	-	-	729	681	-	424	436	-
Stage 2	-	-	-	-	-	-	428	430	-	742	680	-
Platoon blocked, %	-	-	-	-	-	-	-	-	-	-	-	-
Mov Cap-1 Maneuver	870	-	-	1295	-	-	206	227	765	219	230	425
Mov Cap-2 Maneuver	-	-	-	-	-	-	206	227	-	219	230	-
Stage 1	-	-	-	-	-	-	699	653	-	406	424	-
Stage 2	-	-	-	-	-	-	399	418	-	719	652	-
Approach	EB		WB		NB		SB					
HCM Control Delay, s	0.7		0.1		19.5		20.7					
HCM LOS	C		C		C		C					
Minor Lane/Major Mvmt	NBLn1	EBL	EBT	EBR	WBL	WBT	WBR	SBLn1				
Capacity (veh/h)	252	870	-	-	1295	-	-	280				
HCM Lane V/C Ratio	0.016	0.02	-	-	0.005	-	-	0.182				
HCM Control Delay (s)	19.5	9.2	0	-	7.8	0	-	20.7				
HCM Lane LOS	C	A	A	-	A	A	-	C				
HCM 95th %tile Q(veh)	0	0.1	-	-	0	-	-	0.7				

Lanes, Volumes, Timings
2: Preston & Gladstone

951 Gladstone & 145 Loretta
Future Total - PM Peak Hour

Lane Group	EBL	EBT	EBR	WBL	WBT	WBR	NBL	NBT	NBR	SBL	SBT	SBR
Lane Configurations		↔		↔	↔		↔	↔		↔	↔	
Traffic Volume (vph)	27	205	67	80	491	77	95	374	101	52	364	57
Future Volume (vph)	27	205	67	80	491	77	95	374	101	52	364	57
Satd. Flow (prot)	0	1628	0	1658	1665	0	1658	1633	0	1658	1657	0
Fit Permitted		0.758		0.553			0.414			0.361		
Satd. Flow (perm)	0	1234	0	905	1665	0	654	1633	0	597	1657	0
Satd. Flow (RTOR)					13			25				
Lane Group Flow (vph)	0	299	0	80	568	0	95	475	0	52	421	0
Turn Type	Perm	NA		Perm	NA		Perm	NA		Perm	NA	
Protected Phases		4			8			2		6		
Permitted Phases	4				8			2		6		
Detector Phase	4	4			8	8		2	2	6	6	
Switch Phase												
Minimum Initial (s)	10.0	10.0		10.0	10.0		10.0	10.0		10.0	10.0	
Minimum Split (s)	24.5	24.5		24.5	24.5		23.7	23.7		23.7	23.7	
Total Split (s)	33.0	33.0		33.0	33.0		37.0	37.0		37.0	37.0	
Total Split (%)	47.1%	47.1%		47.1%	47.1%		52.9%	52.9%		52.9%	52.9%	
Yellow Time (s)	3.0	3.0		3.0	3.0		3.3	3.3		3.3	3.3	
All-Red Time (s)	3.5	3.5		3.5	3.5		2.4	2.4		2.4	2.4	
Lost Time Adjust (s)		0.0		0.0	0.0		0.0	0.0		0.0	0.0	
Total Lost Time (s)		6.5		6.5	6.5		5.7	5.7		5.7	5.7	
Lead/Lag												
Lead-Lag Optimize?												
Recall Mode	None	None		None	None		C-Min	C-Min		C-Min	C-Min	
Act Effct Green (s)		26.7		26.7	26.7		31.1	31.1		31.1	31.1	
Actuated g/C Ratio		0.38		0.38	0.38		0.44	0.44		0.44	0.44	
v/c Ratio		0.63		0.23	0.88		0.33	0.64		0.20	0.57	
Control Delay		21.6		16.2	37.4		17.5	19.7		15.0	18.9	
Queue Delay		0.0		0.0	0.0		0.0	0.0		0.0	0.0	
Total Delay		21.6		16.2	37.4		17.5	19.7		15.0	18.9	
LOS		C		B	D		B	B		B	B	
Approach Delay		21.6			34.8			19.4			18.4	
Approach LOS		C			C			B			B	
Queue Length 50th (m)		19.1		6.3	60.4		8.5	48.0		4.3	43.1	
Queue Length 95th (m)		56.9		16.2	#123.9		18.4	72.9		10.7	64.5	
Internal Link Dist (m)		137.4			149.8			122.5			139.6	
Turn Bay Length (m)					37.5			24.0			28.0	
Base Capacity (vph)		488		357	666		301	765		274	762	
Starvation Cap Reductn		0		0	0		0	0		0	0	
Spillback Cap Reductn		0		0	0		0	0		0	0	
Storage Cap Reductn		0		0	0		0	0		0	0	
Reduced v/c Ratio		0.61		0.22	0.85		0.32	0.62		0.19	0.55	
Intersection Summary												
Cycle Length: 70												
Actuated Cycle Length: 70												
Offset: 40 (57%), Referenced to phase 2:NBTL and 6:SBTL, Start of Green												
Natural Cycle: 60												
Control Type: Actuated-Coordinated												

Lanes, Volumes, Timings
2: Preston & Gladstone

951 Gladstone & 145 Loretta
Future Total - PM Peak Hour

Maximum v/c Ratio: 0.88	Intersection LOS: C
Intersection Signal Delay: 24.5	ICU Level of Service F
Intersection Capacity Utilization 92.6%	
Analysis Period (min) 15	
# 95th percentile volume exceeds capacity, queue may be longer.	
Queue shown is maximum after two cycles.	

Splits and Phases: 2: Preston & Gladstone

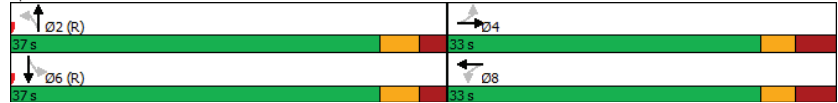

HCM 2010 TWSC
3: Breezehill & Somerset

951 Gladstone & 145 Loretta
Future Total - PM Peak Hour

Intersection						
Int Delay, s/veh	1.3					
Movement	EBT	EBR	WBL	WBT	NBL	NBR
Lane Configurations	↔		↔		↔	
Traffic Vol, veh/h	316	28	20	418	31	19
Future Vol, veh/h	316	28	20	418	31	19
Conflicting Peds, #/hr	0	100	100	0	19	0
Sign Control	Free	Free	Free	Free	Stop	Stop
RT Channelized	-	None	-	None	-	None
Storage Length	-	-	-	-	0	-
Veh in Median Storage, #	0	-	-	0	0	-
Grade, %	0	-	-	0	0	-
Peak Hour Factor	100	100	100	100	100	100
Heavy Vehicles, %	2	2	2	2	2	2
Mvmt Flow	316	28	20	418	31	19

Major/Minor	Major1	Major2	Minor1
Conflicting Flow All	0	0	444
Stage 1	-	-	430
Stage 2	-	-	477
Critical Hdwy	-	4.12	6.42
Critical Hdwy Stg 1	-	-	5.42
Critical Hdwy Stg 2	-	-	5.42
Follow-up Hdwy	-	2.218	3.318
Pot Cap-1 Maneuver	-	1116	306
Stage 1	-	-	656
Stage 2	-	-	624
Platoon blocked, %	-	-	-
Mov Cap-1 Maneuver	-	1029	271
Mov Cap-2 Maneuver	-	-	271
Stage 1	-	-	605
Stage 2	-	-	600

Approach	EB	WB	NB
HCM Control Delay, s	0	0.4	17.4
HCM LOS			C

Minor Lane/Major Mvmt	NBLn1	EBT	EBR	WBL	WBT
Capacity (veh/h)	339	-	-	1029	-
HCM Lane V/C Ratio	0.147	-	-	0.019	-
HCM Control Delay (s)	17.4	-	-	8.6	0
HCM Lane LOS	C	-	-	A	A
HCM 95th %tile Q(veh)	0.5	-	-	0.1	-

HCM 2010 TWSC
6: Loretta & Gladstone

951 Gladstone & 145 Loretta
Future Total - PM Peak Hour

Intersection												
Int Delay, s/veh	5.8											
Movement	EBL	EBT	EBR	WBL	WBT	WBR	NBL	NBT	NBR	SBL	SBT	SBR
Lane Configurations	↕			↕			↕			↕		
Traffic Vol, veh/h	36	205	4	9	593	55	15	0	6	81	2	84
Future Vol, veh/h	36	205	4	9	593	55	15	0	6	81	2	84
Conflicting Peds, #/hr	36	0	35	35	0	36	2	0	4	4	0	2
Sign Control	Free	Free	Free	Free	Free	Free	Stop	Stop	Stop	Stop	Stop	Stop
RT Channelized	-	-	None	-	-	None	-	-	None	-	-	None
Storage Length	-	-	-	-	-	-	-	-	-	-	-	-
Veh in Median Storage, #	-	0	-	-	0	-	-	0	-	-	0	-
Grade, %	-	0	-	-	0	-	-	0	-	-	0	-
Peak Hour Factor	100	100	100	100	100	100	100	100	100	100	100	100
Heavy Vehicles, %	2	2	2	2	2	2	2	2	2	2	2	2
Mvmt Flow	36	205	4	9	593	55	15	0	6	81	2	84
Major/Minor	Major1			Major2			Minor1			Minor2		
Conflicting Flow All	684	0	0	244	0	0	998	1016	246	961	991	659
Stage 1	-	-	-	-	-	-	314	314	-	675	675	-
Stage 2	-	-	-	-	-	-	684	702	-	286	316	-
Critical Hdwy	4.12	-	-	4.12	-	-	7.12	6.52	6.22	7.12	6.52	6.22
Critical Hdwy Stg 1	-	-	-	-	-	-	6.12	5.52	-	6.12	5.52	-
Critical Hdwy Stg 2	-	-	-	-	-	-	6.12	5.52	-	6.12	5.52	-
Follow-up Hdwy	2.218	-	-	2.218	-	-	3.518	4.018	3.318	3.518	4.018	3.318
Pot Cap-1 Maneuver	909	-	-	1322	-	-	223	238	793	236	246	464
Stage 1	-	-	-	-	-	-	697	656	-	444	453	-
Stage 2	-	-	-	-	-	-	439	440	-	721	655	-
Platoon blocked, %	-	-	-	-	-	-	-	-	-	-	-	-
Mov Cap-1 Maneuver	884	-	-	1286	-	-	167	212	769	217	219	450
Mov Cap-2 Maneuver	-	-	-	-	-	-	167	212	-	217	219	-
Stage 1	-	-	-	-	-	-	647	609	-	412	435	-
Stage 2	-	-	-	-	-	-	351	423	-	680	608	-
Approach	EB			WB			NB			SB		
HCM Control Delay, s	1.4			0.1			23.5			32.4		
HCM LOS	A			A			C			D		
Minor Lane/Major Mvmt	NBLn1	EBL	EBT	EBR	WBL	WBT	WBR	SBLn1				
Capacity (veh/h)	215	884	-	-	1286	-	-	293				
HCM Lane V/C Ratio	0.098	0.041	-	-	0.007	-	-	0.57				
HCM Control Delay (s)	23.5	9.2	0	-	7.8	0	-	32.4				
HCM Lane LOS	C	A	A	-	A	A	-	D				
HCM 95th %tile Q(veh)	0.3	0.1	-	-	0	-	-	3.3				

HCM 2010 AWSC
7: Breezehill & Laurel

951 Gladstone & 145 Loretta
Future Total - PM Peak Hour

Intersection												
Intersection Delay, s/veh	7.4											
Intersection LOS	A											
Movement	EBL	EBT	EBR	WBL	WBT	WBR	NBL	NBT	NBR	SBL	SBT	SBR
Lane Configurations	↕			↕			↕			↕		
Traffic Vol, veh/h	12	11	10	4	29	21	24	22	1	9	45	32
Future Vol, veh/h	12	11	10	4	29	21	24	22	1	9	45	32
Peak Hour Factor	1.00	1.00	1.00	1.00	1.00	1.00	1.00	1.00	1.00	1.00	1.00	1.00
Heavy Vehicles, %	2	2	2	2	2	2	2	2	2	2	2	2
Mvmt Flow	12	11	10	4	29	21	24	22	1	9	45	32
Number of Lanes	0	1	0	0	1	0	0	1	0	0	1	0
Approach	EB			WB			NB			SB		
Opposing Approach	WB			EB			SB			NB		
Opposing Lanes	1			1			1			1		
Conflicting Approach Left	SB			NB			EB			WB		
Conflicting Lanes Left	1			1			1			1		
Conflicting Approach Right	NB			SB			WB			EB		
Conflicting Lanes Right	1			1			1			1		
HCM Control Delay	7.3			7.3			7.5			7.4		
HCM LOS	A			A			A			A		
Lane	NBLn1	EBLn1	WBLn1	SBLn1								
Vol Left, %	51%	36%	7%	10%								
Vol Thru, %	47%	33%	54%	52%								
Vol Right, %	2%	30%	39%	37%								
Sign Control	Stop	Stop	Stop	Stop								
Traffic Vol by Lane	47	33	54	86								
LT Vol	24	12	4	9								
Through Vol	22	11	29	45								
RT Vol	1	10	21	32								
Lane Flow Rate	47	33	54	86								
Geometry Grp	1	1	1	1								
Degree of Util (X)	0.055	0.038	0.06	0.094								
Departure Headway (Hd)	4.239	4.096	3.97	3.918								
Convergence, Y/N	Yes	Yes	Yes	Yes								
Cap	838	864	892	908								
Service Time	2.297	2.167	2.038	1.97								
HCM Lane V/C Ratio	0.056	0.038	0.061	0.095								
HCM Control Delay	7.5	7.3	7.3	7.4								
HCM Lane LOS	A	A	A	A								
HCM 95th %tile Q	0.2	0.1	0.2	0.3								

Lanes, Volumes, Timings
8: Bayswater & Gladstone

951 Gladstone & 145 Loretta
Future Total - PM Peak Hour

Lane Group	EBL	EBT	EBR	WBL	WBT	WBR	NBL	NBT	NBR	SBL	SBT	SBR
Lane Configurations		↔			↔			↔			↔	
Traffic Volume (vph)	10	174	18	74	497	114	29	182	28	35	206	34
Future Volume (vph)	10	174	18	74	497	114	29	182	28	35	206	34
Satd. Flow (prot)	0	1707	0	0	1669	0	0	1697	0	0	1694	0
Fit Permitted		0.966			0.943			0.935			0.934	
Satd. Flow (perm)	0	1652	0	0	1575	0	0	1594	0	0	1589	0
Satd. Flow (RTOR)		12			24			12			12	
Lane Group Flow (vph)	0	202	0	0	685	0	0	239	0	0	275	0
Turn Type	Perm	NA		Perm	NA		Perm	NA		Perm	NA	
Protected Phases		2			6			8			4	
Permitted Phases	2			6			8			4		
Detector Phase	2	2		6	6		8	8		4	4	
Switch Phase												
Minimum Initial (s)	10.0	10.0		10.0	10.0		10.0	10.0		10.0	10.0	
Minimum Split (s)	22.5	22.5		22.5	22.5		22.5	22.5		22.5	22.5	
Total Split (s)	36.0	36.0		36.0	36.0		24.0	24.0		24.0	24.0	
Total Split (%)	60.0%	60.0%		60.0%	60.0%		40.0%	40.0%		40.0%	40.0%	
Yellow Time (s)	3.0	3.0		3.0	3.0		3.3	3.3		3.3	3.3	
All-Red Time (s)	2.5	2.5		2.5	2.5		2.0	2.0		2.0	2.0	
Lost Time Adjust (s)		0.0			0.0			0.0			0.0	
Total Lost Time (s)		5.5			5.5			5.3			5.3	
Lead/Lag												
Lead-Lag Optimize?												
Recall Mode	C-Max	C-Max		C-Max	C-Max		Max	Max		Max	Max	
Act Effct Green (s)		30.5			30.5			18.7			18.7	
Actuated g/C Ratio		0.51			0.51			0.31			0.31	
v/c Ratio		0.24			0.84			0.47			0.55	
Control Delay		8.7			24.8			19.6			21.3	
Queue Delay		0.0			0.0			0.0			0.0	
Total Delay		8.7			24.8			19.6			21.3	
LOS		A			C			B			C	
Approach Delay		8.7			24.8			19.6			21.3	
Approach LOS		A			C			B			C	
Queue Length 50th (m)		10.7			57.6			19.8			23.6	
Queue Length 95th (m)		20.7			#120.0			37.4			43.5	
Internal Link Dist (m)		95.1			81.5			119.0			98.4	
Turn Bay Length (m)												
Base Capacity (vph)		845			812			505			503	
Starvation Cap Reductn		0			0			0			0	
Spillback Cap Reductn		0			0			0			0	
Storage Cap Reductn		0			0			0			0	
Reduced v/c Ratio		0.24			0.84			0.47			0.55	

Intersection Summary

Cycle Length: 60
Actuated Cycle Length: 60
Offset: 53 (88%), Referenced to phase 2:EBTL and 6:WBTL, Start of Green
Natural Cycle: 60
Control Type: Actuated-Coordinated

Lanes, Volumes, Timings
8: Bayswater & Gladstone

951 Gladstone & 145 Loretta
Future Total - PM Peak Hour

Maximum v/c Ratio: 0.84	Intersection LOS: C
Intersection Signal Delay: 20.9	ICU Level of Service E
Intersection Capacity Utilization 87.9%	
Analysis Period (min) 15	
# 95th percentile volume exceeds capacity, queue may be longer.	
Queue shown is maximum after two cycles.	

Splits and Phases: 8: Bayswater & Gladstone

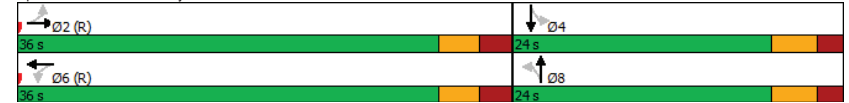

Lanes, Volumes, Timings
9: Gladstone

951 Gladstone & 145 Loretta
Future Total - PM Peak Hour

Lane Group	EBL	EBT	EBR	WBL	WBT	WBR	NBL	NBT	NBR	SBL	SBT	SBR
Lane Configurations		↑			↑							
Traffic Volume (vph)	0	292	0	0	657	0	0	0	0	0	0	0
Future Volume (vph)	0	292	0	0	657	0	0	0	0	0	0	0
Satd. Flow (prot)	0	1745	0	0	1745	0	0	0	0	0	0	0
Fit Permitted												
Satd. Flow (perm)	0	1745	0	0	1745	0	0	0	0	0	0	0
Satd. Flow (RTOR)												
Lane Group Flow (vph)	0	292	0	0	657	0	0	0	0	0	0	0
Turn Type		NA			NA							
Protected Phases		2			6							
Permitted Phases												
Detector Phase		2			6							
Switch Phase												
Minimum Initial (s)		10.0			10.0							
Minimum Split (s)		22.5			22.5							
Total Split (s)		50.0			50.0							
Total Split (%)		71.4%			71.4%							
Yellow Time (s)		3.0			3.0							
All-Red Time (s)		1.9			1.9							
Lost Time Adjust (s)		0.0			0.0							
Total Lost Time (s)		4.9			4.9							
Lead/Lag												
Lead-Lag Optimize?												
Recall Mode		C-Max			C-Max							
Act Effct Green (s)		56.8			56.8							
Actuated g/C Ratio		0.81			0.81							
v/c Ratio		0.21			0.46							
Control Delay		3.6			3.1							
Queue Delay		0.0			0.0							
Total Delay		3.6			3.1							
LOS		A			A							
Approach Delay		3.6			3.1							
Approach LOS		A			A							
Queue Length 50th (m)		11.9			19.8							
Queue Length 95th (m)		20.3			m28.9							
Internal Link Dist (m)		139.1			137.4			12.5			12.7	
Turn Bay Length (m)												
Base Capacity (vph)		1416			1416							
Starvation Cap Reductn		0			59							
Spillback Cap Reductn		0			0							
Storage Cap Reductn		0			0							
Reduced v/c Ratio		0.21			0.48							
Intersection Summary												
Cycle Length: 70												
Actuated Cycle Length: 70												
Offset: 0 (0%), Referenced to phase 2:EBT and 6:WBT, Start of Green												
Natural Cycle: 55												
Control Type: Actuated-Coordinated												

Lanes, Volumes, Timings
9: Gladstone

951 Gladstone & 145 Loretta
Future Total - PM Peak Hour

Lane Group	Ø4	Ø8
Lane Configurations		
Traffic Volume (vph)		
Future Volume (vph)		
Satd. Flow (prot)		
Fit Permitted		
Satd. Flow (perm)		
Satd. Flow (RTOR)		
Lane Group Flow (vph)		
Turn Type		
Protected Phases	4	8
Permitted Phases		
Detector Phase		
Switch Phase		
Minimum Initial (s)	10.0	10.0
Minimum Split (s)	18.0	18.0
Total Split (s)	20.0	20.0
Total Split (%)	29%	29%
Yellow Time (s)	3.0	3.0
All-Red Time (s)	1.1	1.1
Lost Time Adjust (s)		
Total Lost Time (s)		
Lead/Lag		
Lead-Lag Optimize?		
Recall Mode	None	None
Act Effct Green (s)		
Actuated g/C Ratio		
v/c Ratio		
Control Delay		
Queue Delay		
Total Delay		
LOS		
Approach Delay		
Approach LOS		
Queue Length 50th (m)		
Queue Length 95th (m)		
Internal Link Dist (m)		
Turn Bay Length (m)		
Base Capacity (vph)		
Starvation Cap Reductn		
Spillback Cap Reductn		
Storage Cap Reductn		
Reduced v/c Ratio		
Intersection Summary		

Lanes, Volumes, Timings
9: Gladstone

951 Gladstone & 145 Loretta
Future Total - PM Peak Hour

Maximum v/c Ratio: 0.46	Intersection LOS: A
Intersection Signal Delay: 3.3	ICU Level of Service A
Intersection Capacity Utilization 40.6%	
Analysis Period (min) 15	
m Volume for 95th percentile queue is metered by upstream signal.	

Splits and Phases: 9: Gladstone

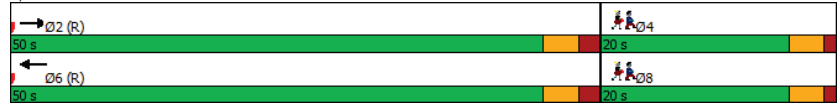

HCM 2010 TWSC
5: Loretta & Access #1

951 Gladstone & 145 Loretta
Future Total - PM Peak Hour

Intersection						
Int Delay, s/veh	4.7					
Movement	WBL	WBR	NBT	NBR	SBL	SBT
Lane Configurations	↔	↔	↔	↔	↔	↔
Traffic Vol, veh/h	114	14	49	42	7	52
Future Vol, veh/h	114	14	49	42	7	52
Conflicting Peds, #/hr	0	0	0	0	0	0
Sign Control	Stop	Stop	Free	Free	Free	Free
RT Channelized	-	None	-	None	-	None
Storage Length	0	-	-	-	-	-
Veh in Median Storage, #	0	-	0	-	-	0
Grade, %	0	-	0	-	-	0
Peak Hour Factor	100	100	100	100	100	100
Heavy Vehicles, %	2	2	2	2	2	2
Mvmt Flow	114	14	49	42	7	52

Major/Minor	Minor1	Major1	Major2
Conflicting Flow All	136	70	0
Stage 1	70	-	-
Stage 2	66	-	-
Critical Hdwy	6.42	6.22	-
Critical Hdwy Stg 1	5.42	-	-
Critical Hdwy Stg 2	5.42	-	-
Follow-up Hdwy	3,518	3,318	-
Pot Cap-1 Maneuver	857	993	-
Stage 1	953	-	-
Stage 2	957	-	-
Platoon blocked, %	-	-	-
Mov Cap-1 Maneuver	853	993	-
Mov Cap-2 Maneuver	853	-	-
Stage 1	953	-	-
Stage 2	952	-	-

Approach	WB	NB	SB
HCM Control Delay, s	9.9	0	0.9
HCM LOS	A		

Minor Lane/Major Mvmt	NBT	NBRWBLn1	SBL	SBT
Capacity (veh/h)	-	-	866	1504
HCM Lane V/C Ratio	-	-	0.148	0.005
HCM Control Delay (s)	-	-	9.9	7.4
HCM Lane LOS	-	-	A	A
HCM 95th %tile Q(veh)	-	-	0.5	0

HCM 2010 TWSC
4: Loretta & Access #2

951 Gladstone & 145 Loretta
Future Total - PM Peak Hour

Intersection						
Int Delay, s/veh	1					
Movement	WBL	WBR	NBT	NBR	SBL	SBT
Lane Configurations	↔		↑			↑
Traffic Vol, veh/h	7	7	63	0	0	52
Future Vol, veh/h	7	7	63	0	0	52
Conflicting Peds, #/hr	0	0	0	0	0	0
Sign Control	Stop	Stop	Free	Free	Free	Free
RT Channelized	-	None	-	None	-	None
Storage Length	0	-	-	-	-	-
Veh in Median Storage, #	0	-	0	-	-	0
Grade, %	0	-	0	-	-	0
Peak Hour Factor	100	100	100	100	100	100
Heavy Vehicles, %	2	2	2	2	2	2
Mvmt Flow	7	7	63	0	0	52

Major/Minor	Minor1	Major1	Major2
Conflicting Flow All	115	63	0
Stage 1	63	-	-
Stage 2	52	-	-
Critical Hdwy	6.42	6.22	-
Critical Hdwy Stg 1	5.42	-	-
Critical Hdwy Stg 2	5.42	-	-
Follow-up Hdwy	3.518	3.318	-
Pot Cap-1 Maneuver	881	1002	0
Stage 1	960	-	0
Stage 2	970	-	0
Platoon blocked, %	-	-	-
Mov Cap-1 Maneuver	881	1002	-
Mov Cap-2 Maneuver	881	-	-
Stage 1	960	-	-
Stage 2	970	-	-

Approach	WB	NB	SB
HCM Control Delay, s	8.9	0	0
HCM LOS	A		

Minor Lane/Major Mvmt	NBTWBLn1	SBT
Capacity (veh/h)	-	938
HCM Lane V/C Ratio	-	0.015
HCM Control Delay (s)	-	8.9
HCM Lane LOS	-	A
HCM 95th %tile Q(veh)	-	0

HCM 2010 TWSC
10: Loretta & Access #3

951 Gladstone & 145 Loretta
Future Total - PM Peak Hour

Intersection						
Int Delay, s/veh	0.7					
Movement	WBL	WBR	NBT	NBR	SBL	SBT
Lane Configurations	↔		↔			↔
Traffic Vol, veh/h	7	1	61	9	2	47
Future Vol, veh/h	7	1	61	9	2	47
Conflicting Peds, #/hr	0	0	0	0	0	0
Sign Control	Stop	Stop	Free	Free	Free	Free
RT Channelized	-	None	-	None	-	None
Storage Length	0	-	-	-	-	-
Veh in Median Storage, #	0	-	0	-	-	0
Grade, %	0	-	0	-	-	0
Peak Hour Factor	100	100	100	100	100	100
Heavy Vehicles, %	2	2	2	2	2	2
Mvmt Flow	7	1	61	9	2	47

Major/Minor	Minor1	Major1	Major2
Conflicting Flow All	117	66	0
Stage 1	66	-	-
Stage 2	51	-	-
Critical Hdwy	6.42	6.22	4.12
Critical Hdwy Stg 1	5.42	-	-
Critical Hdwy Stg 2	5.42	-	-
Follow-up Hdwy	3.518	3.318	2.218
Pot Cap-1 Maneuver	879	998	1531
Stage 1	957	-	-
Stage 2	971	-	-
Platoon blocked, %	-	-	-
Mov Cap-1 Maneuver	878	998	1531
Mov Cap-2 Maneuver	878	-	-
Stage 1	957	-	-
Stage 2	970	-	-

Approach	WB	NB	SB
HCM Control Delay, s	9.1	0	0.3
HCM LOS	A		

Minor Lane/Major Mvmt	NBT	NBRWBLn1	SBL	SBT
Capacity (veh/h)	-	-	891	1531
HCM Lane V/C Ratio	-	-	0.009	0.001
HCM Control Delay (s)	-	-	9.1	7.4
HCM Lane LOS	-	-	A	A
HCM 95th %tile Q(veh)	-	-	0	0

Appendix I

Signal Warrant – OTM Justification 7

Gladstone Ave @ Loretta Ave N
 Future Total

Justification #7

Justification	Description	Minimum Requirement		Minimum Requirement		Compliance			Signal
		1 Lane Highway		2 or More Lanes		Sectional		Entire %	
		Free Flow	Restr. Flow	Free Flow	Restr. Flow	Numerical	%		
1. Minimum Vehicular Volume	A. Vehicle volume, all approaches (average hour)	480	720	600	900	428	59%	40%	No
	B. Vehicle volume, along minor streets (average hour)	120	170	120	170	68	40%		
2. Delay to Cross Traffic	A. Vehicle volumes, major street (average hour)	480	720	600	900	360	50%	49%	No
	B. Combined vehicle and pedestrian volume crossing artery from minor streets (average hour)	50	75	50	75	37	49%		

Notes

1. Refer to OTM Book 12, pg 92, Mar 2012
2. Lowest section percentage governs justification
3. Average hourly volumes estimated from peak hour volumes, $AHV = PM/2$ or $(AM + PM) / 4$, including amplification factors
4. T-intersection factor corrected, applies only to 1B