



2180 Montreal Rd,  
Ottawa, ON

# STORMWATER MANAGEMENT REPORT

FOR PROPERTY OF PETRO-CANADA LOCATED AT

**2180 MONTREAL RD, OTTAWA, ONTARIO**

Prepared For  
**SUNCOR ENERGY PRODUCTS PARTNERSHIP**



Prepared By  
J and B Engineering Inc.  
25 Centurian Drive, Suite 201  
Markham, Ontario  
L3R 5N8

April, 2026



## Table of Contents

1. INTRODUCTION .....	4
2. GENERAL INFORMATION .....	4
2.1 STUDY AREA .....	4
2.2 BACKGROUND .....	5
2.3 OBJECTIVES OF DRAINAGE AND STORMWATER MANAGEMENT STUDY .....	5
3. DESIGN .....	6
3.1 DESIGN CRITERIA .....	6
3.2 SITE DRAINAGE CONDITIONS .....	6
3.2.1 EXISTING DRAINAGE CONDITIONS .....	6
3.2.2 PROPOSED DRAINAGE CONDITIONS .....	7
3.3 ALLOWABLE RELEASE RATE .....	8
3.4 PROPOSED STORMWATER MANAGEMENT PLAN .....	9
3.4.1 QUANTITY CONTROL .....	9
3.4.2 QUANTITY CONTROL SUMMARY .....	13
3.4.3 WATER BALANCE TARGET .....	14
3.4.4 QUALITY CONTROL .....	15
4. OPERATIONS AND MAINTENANCE MANUAL .....	15
5. EROSION AND SEDIMENT CONTROL DURING CONSTRUCTION .....	15
6. SUMMARY AND CONCLUSION .....	16

## TABLES

Table 3-1 Runoff coefficients for Pre-development controlled catchment 1 .....	7
Table 3-2 Runoff coefficients for Pre-development controlled catchment 2 .....	7
Table 3-3 Runoff coefficients for Post-development catchment 1 .....	8
Table 3-4 Runoff coefficients for Post-development catchment 2 .....	8
Table 3-5 Adjusted runoff coefficients .....	8
Table 3-6 Peak Flows 5 - 100 Year Events (Controlled) .....	9
Table 3-7 Peak Flows 5 - 100 Year Events (Uncontrolled) .....	10
Table 3-8 Required Storage Volume for 100yr storm event (Catchment 1) .....	11
Table 3-9 Summary of Actual Storage Provided in Stormwater management structures for Catchment 1 .....	11
Table 3-10 Summary of Actual Storage Provided in Ponding for Catchment 1 .....	12
Table 3-11 Summary of Actual Storage Provided in Underground conduits for Catchment 1 .....	12



Table 3-12 Summary of Total Storage for Catchment 1..... 12

Table 3-13 Summary of Actual Storage Provided..... 13

Table 3-14 Water balance requirement for the site..... 14

Table 3-15 Water Balance – Total Water Retained on site..... 14

FIGURES

Figure 1: Study Area..... 4

## 1. INTRODUCTION

This stormwater management report was prepared on April 2026 by James Sam (P.Eng with direct experience with the Ministry related items for 15+ years in the civil field) for the site located in 2180 Montreal Rd to meet the stormwater management objectives set out by the MOE, City of Ottawa and the MECP and in a manner that mitigates any adverse effects. This report is accurate as of April 2026 based on the site assessment conducted in respect to the catchment area of the stormwater management works and following information provided:

- (1) Topographical and Legal survey by Northern Link Survey Group dated 23 November 2024
- (2) City Record Drawing obtained from City of Ottawa : (Drg No: 87-1268-6 prepared by R.W. Connerly Associated Ltd dated April 1988)
- (3) Site plan prepared by K Paul Archirect Inc dated 2026-04-02
- (4) Geotechnical Investigation Report prepared by Terrapex dated May 24, 2024

## 2. GENERAL INFORMATION

### 2.1 Study Area

The study area is located at south-west corner of the intersection of Shefford Rd and Montreal Rd. The civic address for this property is 2180 Montreal Rd, Ottawa, Ontario and is shown in Figure 1. The study area includes two existing properties which are to be combined. The larger property is an existing gas station and a car wash and the other is a small residential development with a house. Please refer to SP1 in the appendix. The proposed redevelopment scope includes relocation of gas pumps and relocation of the existing convenience store into a new building to include a drive through restaurant. A portion of the site will be redeveloped to accommodate for the abovementioned changes.



Figure 1: Study Area



I, James Sam conducted an assessment of the site and in my opinion, the proposed activity is an activity prescribed by section 2 of Environmental Protection Act - O. Reg. 245/11 -Registration under Part II.2 of the Act – General. The main activities proposed at this site as part of this redevelopment are fuel refilling, instore sales, drive through sales, and a carwash. Monitoring wells have been installed at various locations throughout the site to monitor any impact to the groundwater from the proposed activities at this site.

The site is located within the Rideau Valley Source Protection Area and not within any drinking water intake protection zones or well head protection areas. Moreover, the site is situated in Ottawa, and not located in the Lake Simcoe watershed, Niagara escarpment planning area, the portion of the Oak Ridges Moraine Area or the protected countryside in the greenbelt plan established under the Greenbelt Act 2025.

The precipitation patterns in this area is characterized by a humid continental climate with precipitation throughout the year, including snowy winters and wet summer months. Although annual precipitation is consistent, the highest rainfall typically occurs in late spring and summer, particularly in June while early spring conditions are influenced by snowmelt and increased runoff.

The site itself is generally flat, with most drainage contained internally; however, a portion along the property boundary adjacent to Shefford Rd and Montreal Rd currently drains toward the right-of-way. As per the Geotechnical Report prepared by Terrapex dated May 24, 2024, the groundwater depth at the site varies between 0.7 to 1.7 meters below ground surface. As per the report, the nature of the soil beneath the topsoil is mostly Sily clay.

## 2.2 Background

This study addresses the Stormwater Management (SWM) requirements for the proposed redevelopment and provides details for stormwater quantity and quality control to ensure that the proposed development will not have any adverse effects on the existing drainage system.

## 2.3 Objectives of Drainage and Stormwater Management Study

The objectives of the SWM study are to develop a strategy that will:

- Identify potential stormwater runoff (quality and quantity) impacts to the receiving watercourses from the proposed development area.
- Address concerns from the review agencies including the City of Ottawa, and the Ministry of Environment, Conservation and Parks (MECP) for the preparation of a Stormwater Management study for quantity & quality purposes.
- Provide an appropriate site drainage system for safe operational use.

### 3. DESIGN

#### 3.1 Design criteria

General Stormwater Management guidelines and information was obtained from the criteria outlined in the comments received from City of Ottawa dated 2025, the Stormwater Management Planning and Design Manual 2003 and Ontario MOE: *Understanding Stormwater Management: An Introduction to Stormwater Management Planning and Design*.

The post-development hydrologic conditions for the site were established utilizing the current (IDF information derived from the Meteorological Services of Canada rainfall data taken from the MacDonald Cartier Airport) including the current 5-Year to 100-Year IDF data. A conservative surface run-off coefficient of 0.90 was used for impervious surfaces and 0.25 was used for pervious surfaces (ie. landscape). (Refer to drainage plan P-302). Considering the subject property is a relatively small area, the “Modified Rational Method” was used to calculate the predevelopment and post development flow generated from the property.

#### 3.2 Site Drainage Conditions

##### 3.2.1 Existing Drainage Conditions

The existing gas station property is fully developed with a car wash, pumping station and a convenience store with an area of 0.51 ha. The rear property which is to be included with this site as part of the redevelopment, includes a residential dwelling and a driveway with an area of 0.09 ha. The existing commercial property is fully developed with drainage structures and conveyance system in place. It is currently directing the captured drainage to the municipal storm sewer along Shefford Rd. The site topography drains in the easterly direction towards Shefford Rd. The residential property does not have any stormwater management controls in place.

The study area is delineated into two catchments for both predevelopment and post development conditions, identified as controlled catchment 1 and uncontrolled sub-catchment 2. Refer to Drainage Plan P-302.

##### **Predevelopment Catchment-1 (Controlled)**

The controlled Predevelopment Catchment-1 consists of the majority of the commercial site area (0.4784 ha). The existing residential property does not have any stormwater control in place, therefore the predevelopment catchment 1 comprises only of the controlled portion of the commercial property. The stormwater runoff from the predevelopment catchment-1 is captured by the currently existing stormwater catchment structures within the commercial property. Table 3-1 below summarizes the existing areas and runoff coefficients for the entire predevelopment-controlled catchment 1.

Surface Composition		Impervious	Pervious Grass / Mulch	Total under consideration
Existing Condition	(m <sup>2</sup> )	3178.72	1605.28	4784
	(ha)	0.318	0.161	0.478
Runoff Coefficient		0.900	0.250	0.68

Table 3-1 Runoff coefficients for Pre-development controlled catchment 1

### Predevelopment Catchment-2 (Uncontrolled)

The Predevelopment catchment -2 (0.128 ha) represents a small strip of landscape area along the north east and east of the commercial property and the entire area of the residential property. This area will flow uncontrolled mostly towards Shefford Rd while a portion will flow on to Montreal Rd and they will both enter the stormwater collection system along the municipal right of way. Table 3-2 below summarize the existing areas and runoff coefficients for the entire predevelopment uncontrolled catchment 2.

Surface Composition		Impervious	Pervious Grass / Mulch	Total under consideration
Existing Condition	(m <sup>2</sup> )	853.46	423.20	1277
	(ha)	0.0853	0.042	0.128
Runoff Coefficient		0.900	0.250	0.68

Table 3-2 Runoff coefficients for Pre-development controlled catchment 2

### 3.2.2 Proposed Drainage Conditions

The post development study area is delineated into two catchments, identified as controlled catchment 1 and uncontrolled sub-catchment 2 (Refer to Drainage Plan P-303).

#### Post-development Catchment-1 (Controlled)

Catchment-1 consist of the majority of the site area (0.5438 ha). The stormwater runoff from the post-development catchment-1 will be captured by various existing and proposed drainage structures throughout the site. The flow will be controlled by a 121mm orifice tube installed at the outlet of STM MH3 and treated by a proposed Jellyfish filter, prior to discharging into the 400mm lateral and eventually into the 550 mm existing storm sewer along Shefford Rd. (Refer to Servicing Plan P-301 in Appendix C). The proposed areas and runoff coefficients and for Post-development catchment-1 are shown in Table 3-3 below:

Surface Composition		Impervious	Pervious Grass	Total under consideration
Proposed Condition	(m <sup>2</sup> )	4159	1279	5438
	(ha)	0.416	0.128	0.544
Runoff Coefficient		0.900	0.250	0.75

Table 3-3 Runoff coefficients for Post-development catchment 1

### Post-development Catchment-2 (Un-controlled)

The uncontrolled catchment -2 (0.072 ha) represents a small strip of landscape area along the northeast and east of the property. This area will sheetflow uncontrolled mostly towards Shefford Rd while a portion will flow on to Montreal Rd and they will both enter the stormwater collection structures along the municipal right of way. The proposed areas and runoff coefficients for the post-development sub-catchment-2 are shown below in Table 3-4.

Surface Composition		Impervious	Pervious Grass	Total under consideration
Proposed Condition	(m <sup>2</sup> )	68	555	623
	(ha)	0.007	0.055	0.062
Runoff Coefficient		0.900	0.250	0.32

Table 3-4 Runoff coefficients for Post-development catchment 2

### 3.3 Allowable Release Rate

For estimating flows using the Rational Method for storms greater than the 10-year return storm, for proposed site conditions, runoff coefficients are increased 10%, 20% and 25% for the 25-year, 50-year and 100-year storms respectively to account for additional runoff due to soil saturation and the reduced accuracy associated with larger storms. (Refer to Table 3-5 below)

St. Event	Controlled	
	Existing	Proposed
Runoff Coefficient		
2-Year	0.500	0.75
5-Year	0.500	0.75
10-Year	0.500	0.75
25-Year	0.500	0.82
50-Year	0.500	0.90
100-Year	0.500	0.93

Table 3-5 Adjusted runoff coefficients



A runoff coefficient of **0.5** was used to generate the flow for existing site condition. The calculated allowable release rate for the project site is as follows:

$$Q = 0.00278 C I A \leftarrow \text{Equation (1)}$$

Where Q: = Maximum Runoff Rate (m<sup>3</sup>/sec)

C: = Runoff Coefficient

I: = Rainfall Intensity (mm/hr) (5 – year storm event)

A: = Drainage Area (ha)

$$Q_{\text{target}} = 0.00278 * 0.5 * 104.19 * 0.478$$

$$Q_{\text{target}} = 0.0693 \text{m}^3/\text{sec} \rightarrow \text{Allowable Release Rate}$$

### 3.4 Proposed Stormwater management plan

#### 3.4.1 Quantity Control

The drainage pattern is expected to change due to the increase in impervious surfaces for the proposed development. In order to satisfy the City requirements, quantity controls have been provided to ensure post development peak run-off is controlled to pre-development levels for the 5 – 100-year storm events.

Onsite storage and flow control is provided using an orifice tube restrictor located at the outlet of Storm Manhole #3 for the post development controlled catchment 1 prior to discharging off-site to limit the release rates to the allowable release rate.

Considering this is a relatively small area, the “Modified Rational Method” was used to generate the surface runoff for each storm event as follows:

#### Proposed Controlled flow rate

The results of peak flow rates (m<sup>3</sup>) generated by the “Modified Rational Method” for existing and proposed conditions for the controlled and uncontrolled catchments in the post development conditions are shown in Table 3-6 & Table 3-7 below.

Storm Event	Rainfall Intensity (mm/hr)				<Equation 1> Flow Rate (m <sup>3</sup> /sec)		
	a	b	c	I	Existing Controlled	Proposed- Controlled	Excess Flow
2- Year	732.951	0.810	6.199	76.81	0.0511	0.0867	0.0357
5- Year	<b>998.071</b>	<b>0.814</b>	<b>6.053</b>	<b>104.19</b>	<b>0.0693</b>	<b>0.1177</b>	<b>0.0484</b>
10- Year	1174.184	0.816	6.014	122.14	0.0812	0.1379	0.0567
25- Year	1402.884	0.819	6.018	144.69	0.0962	0.1798	0.0835
50- Year	1569.580	0.820	6.014	161.47	0.1074	0.2188	0.1115
100- Year	1735.688	0.820	6.014	178.56	0.1187	<b>0.2521</b>	0.1333

Table 3-6 Peak Flows 5 - 100 Year Events (Controlled)

Storm Event	Rainfall Intensity (mm/hr)				<Equation 1> Flow Rate (m <sup>3</sup> /sec)		
	a	b	c	I	Existing - Uncontrolled	Proposed - Uncontrolled	Excess Flow Uncontrolled
2-Year	732.951	0.810	6.199	76.81	0.0187	0.0043	-0.0144
5-Year	<b>998.071</b>	<b>0.814</b>	<b>6.053</b>	<b>104.19</b>	0.0253	0.0058	-0.0195
10-Year	1174.184	0.816	6.014	122.14	0.0297	0.0068	-0.0229
25-Year	1402.884	0.819	6.018	144.69	0.0352	0.0080	-0.0271
50-Year	1569.580	0.820	6.014	161.47	0.0392	0.0090	-0.0303
100-Year	1735.688	0.820	6.014	178.56	0.0434	<b>0.0099</b>	-0.0335

Table 3-7 Peak Flows 5 – 100 Year Events (Uncontrolled)

As per Table 3-6, the allowable release rate for the predevelopment catchment 1 is based on the 5-year storm event which has a flow rate of 0.0693m<sup>3</sup>/s. However, this rate will be reduced to a target flow rate of **0.0594m<sup>3</sup>/s** to compensate for the flow from the uncontrolled post development catchment 2 (0.009m<sup>3</sup>/s). The target release rate will be achieved using an orifice tube restrictor at the outlet of Storm Manhole #3.

Sizing of the orifice is given by the formula.

$$Q = C A \sqrt{2 g h} \quad \leftarrow \text{Equation (2)}$$

Where  $Q$ : = Flow Rate Through Orifice (m<sup>3</sup>/sec) =  $Q_{\text{Allowable}}$

$C$ : = Contraction Coefficient = 0.80 (For Orifice Pipe)

$A$ : = Area of Orifice Pipe (m<sup>2</sup>)

$g$ : = Acceleration Due To Gravity (m/sec<sup>2</sup>) = 9.81 (m/sec<sup>2</sup>)

$h$ : = Pressure Head To Be Dissipated (m)

By trial-and-error calculations, a 121mm orifice pipe is required to control the flow to the Target release rate.

$$Q = (0.80)\pi\left(\frac{0.121}{2}\right)^2 \sqrt{2 * 9.81 * \left(67.45 - 65.29 - \left(\frac{0.121}{2}\right)\right)}$$

$$Q = 0.0590 \text{ m}^3/\text{sec} \leq 0.0594 \text{ m}^3/\text{sec} \text{ (target release rate)}$$

Based on the calculated orifice release rate of  $Q = 0.0590\text{m}^3/\text{s}$ , the required storage for the 100-year storm event is calculated using the “Modified Rational Method” and is shown below Table 3-8.



Storm Event	Tc	Id 100 Years	Qpost	Qorrifice	Excess Flow	Volume(m <sup>3</sup> )
5 Yr Pre 100 Yr Post	5	243	0.3426	0.0590	0.2836	85.088
	7	212	0.2988	0.0590	0.2398	100.721
	10	179	0.2521	0.0590	0.1931	115.842
	15	143	0.2017	0.0590	0.1427	128.448
	20	120	0.1693	0.0590	0.1103	132.394
	25	104	0.1466	0.0590	0.0876	131.391
	30	92	0.1297	0.0590	0.0707	127.229
	35	83	0.1166	0.0590	0.0576	120.893
	40	75	0.1061	0.0590	0.0471	112.978
	45	69	0.0975	0.0590	0.0385	103.868
	50	64	0.0903	0.0590	0.0313	93.824
	55	60	0.0842	0.0590	0.0252	83.032
	60	56	0.0789	0.0590	0.0199	71.628
	65	53	0.0743	0.0590	0.0153	59.713
	70	50	0.0703	0.0590	0.0113	47.367
Max Volume Required						<b>132.39</b>

Table 3-8 Required Storage Volume for 100yr storm event (Catchment 1)

Therefore, the 121mm orifice tube at the outlet of Storm Manhole #3 will generate an on-site required storage of 132.39 m<sup>3</sup>. The storage is met by a combination of underground piping, storm drainage structures (CB's and MH's) and proposed dry ponds above stormwater catchment structures within the subject property. The generated storage is illustrated in the tables below:

Structure	Size	Area	Maximum.	Invert	Volume
	(mm)	(m <sup>2</sup> )	Water level	(m)	(m <sup>3</sup> )
CB1	600x600	0.36	67.45	66.05	0.50
CBMH1	1500	1.77	67.31	65.83	2.61
CB2	600x600	0.36	67.33	65.91	0.51
STM MH1	1200	1.13	67.34	65.63	1.94
CBMH2	1500	1.77	67.20	65.47	3.05
EX.STM MH1	1200	1.13	67.45	66.68	0.87
CB3	600x600	0.36	67.39	66.08	0.47
CBMH3	1200	1.13	67.25	65.93	1.49
CBMH4	1500	1.77	67.20	65.76	2.54
STM MH3	1500	1.77	67.45	65.29	3.81
CB4	600x600	0.36	66.80	65.99	0.29
<b>Sum</b>					<b>18.09</b>

Table 3-9 Summary of Actual Storage Provided in Stormwater management structures for Catchment 1



Ponding	Area	Top of Ponding	Bottom of Ponding	Volume
	( $\text{m}^2$ )			( $\text{m}^3$ )
Ponding 1	132.00	67.45	67.33	5.28
Ponding 2	57.48	67.45	67.31	2.68
Ponding 3	179.96	67.45	67.20	15.00
Ponding 4	381.29	67.45	67.20	31.77
Ponding 5	44.92	67.45	67.25	2.99
Ponding 6	19.48	67.45	67.35	0.65
Ponding 7	88.38	67.45	66.80	31.91
<b>Sum</b>				<b>90.3</b>

Table 3-10 Summary of Actual Storage Provided in Ponding for Catchment 1

Pipe ID	Diameter	Area	Length	Volume
	(mm)	( $\text{m}^2$ )	(m)	( $\text{m}^3$ )
1	250	0.05	19.40	0.95
2	250	0.05	18.20	0.89
3	150	0.02	9.40	0.17
4	150	0.02	9.10	0.16
5	600	0.28	32.30	9.13
6	150	0.02	6.30	0.11
7	150	0.02	9.50	0.17
8	300	0.07	12.90	0.91
9	400	0.13	8.20	1.03
10	250	0.05	20.40	1.00
11	300	0.07	9.40	0.66
12	150	0.02	11.20	0.20
13	600	0.28	28.90	8.17
14	300	0.07	19.50	1.38
15	600	0.28	16.70	4.72
<b>Sum</b>				<b>29.65</b>

Table 3-11 Summary of Actual Storage Provided in Underground conduits for Catchment 1

<b>Storage Volume for 100-year Storm Event (<math>\text{m}^3</math>)</b>	
Catch Basins and Manholes	18.07
Underground Conduits	29.65
Ponding	90.29
<b>Total Provided</b>	<b>138.01</b>
<b>Total Required</b>	<b>132.39</b>

Table 3-12 Summary of Total Storage for Catchment 1

The total storage provided on site for stormwater runoff is  $132.39 \text{ m}^3$  which is more than the required volume of  $132.39 \text{ m}^3$ .



### 50% Blockage

The inlet capacity of the stormwater catchment structures have been analyzed below, assuming 50% blockage-on-site for the 100 yr storm flow rate, using the “MTO Design Chart 4.19 Inlet Capacity at Road Sag”.

Drain Catchment Reference	Drain Reference	Catchment Structure Top Elevation	Max Ponding Elevation	Depth/Head (m)	Inlet Capacity (m <sup>3</sup> /s) (MTO Design 4.19)	Inlet Capacity at 50% Blocked Condition (m <sup>3</sup> /s) <sup>2</sup>	Excess Flow Capacity of CB/MH (m <sup>3</sup> /s)
A	CB1	67.55	67.45		-		
C	CB2	67.33	67.45	0.12	0.09	0.04	0.02
B	CBMH1	67.31	67.45	0.14	0.11	0.06	0.03
D	CBMH2	67.20	67.45	0.25	0.18	0.09	0.06
F	CB3	67.35	67.45	0.10	0.06	0.03	0.01
G	CBMH3	67.25	67.45	0.20	0.16	0.08	0.07
H	CBMH4	67.20	67.45	0.25	0.18	0.09	0.06

Table 3-13 Summary of Actual Storage Provided

The 50% blocked inlet condition capacity of each catchment at 100-Year Post Dev exceeds the 100-Year Post Site flow rate indicating that the catch basins will have sufficient capacity to capture runoffs within the internal storm sewer system.

### 3.4.2 Quantity Control Summary

The overall release rate for the site is the sum of the controlled flow rate from the post-development controlled catchment 1+ the post development uncontrolled flow from the catchment 2. See below for overall release rate.

Overall release rate for the site = Controlled Post-development Catchment 1+ Uncontrolled Post-development Catchment 2

$$Q = 0.0590 + 0.009$$

$$Q = 0.0689 \text{ m}^3/\text{s}$$

Therefore, the overall release rate is 0.0689m<sup>3</sup>/s which is less than the allowable release rate of 0.0693m<sup>3</sup>/s as per calculations shown in section 3.2.1.

The controlled flow from the site will discharge into the city 550mm storm sewer via the existing city owned catch basin along Shefford Rd.

### 3.4.3 Water Balance target

The primary objective of the Water Balance Targets/Criteria is to capture and manage annual rainfall on the development site itself to preserve the pre-development hydrology through a combination of infiltration, evapotranspiration, landscaping, rainwater reuse and/or other low impact development practices. The water balance target for this site is to retain runoff from a **5mm, 24-hour event** as illustrated in Table 3-14.

<b>Total Site Area [m2]</b>	<b>6060.66</b>
Rainfall depth to be retained [m]	5.00
Volume to be retained [m3]	30.30

Table 3-14 Water balance requirement for the site

To achieve the required water balance, the site composition is assigned an initial abstraction value as follows: 5mm (landscape) and 1mm (hard surface -roof/concrete/asphalt).

In addition to the initial abstraction, the dry pond proposed at the southwest corner of the site for quantity control purpose will also contribute to the water balance requirement. However due to high groundwater elevation, limited space and the nature of the type of soil encountered in this site, the amount of water to be infiltrated is limited.

Cover Type	Area	IA	Volume
	[m2]	[mm]	[m3]
Landscape	2028.48	5	10.14
Asphalt/ Concrete	2911.87	1	2.91
Building	1120.30	1	1.12
<b>Total - Initial Abstraction</b>	<b>6060.66</b>	-	<b>14.17</b>
Dry pond #6	-	-	31.91
<b>Total - Infiltration</b>	-	-	<b>31.91</b>
<b>TOTAL WATER RETAINED</b>	-	-	<b>46.08</b>

Table 3-15 Water Balance – Total Water Retained on site

Methods investigated that could not be implemented due site conditions and restrictions included:

1. Green roofs – cannot be implemented due to additional loading to structure and conflicts with mechanical equipment.
2. Infiltration trench – cannot be implemented due to high ground water levels (Based on the Geotech report prepared by Terrapex dated May 24, 2024, the groundwater depth at the site varies between 0.7 to 1.7 meters below ground surface. )
3. Bio-retention – cannot be implemented with the limited amount of space.

Therefore the maximum volume of water that can be retain in the site for water balance purpose is 46.08 m3. Overall, various water balance techniques were explored, and best management practices have been implemented on this project.



### **3.4.4 Quality Control**

Jellyfish JF4-2-1 has been proposed at the outlet of the storm system prior to discharging into the existing City storm network on Shefford Rd. The JF4-2-1 has ETV verification and has a TSS removal rate of 85% based on the sizing report in the Appendix D.

Monitoring of discharge from the JF Filter is required in accordance with the ECA and documentation of the monitoring to be kept on file for a period of 5 years.

## **4. OPERATIONS AND MAINTENANCE MANUAL**

A sediment collection device (stormwater pretreatment device) and other methods are utilized to treat discharge that is leaving the site. Examples of pretreatment devices include, but are not limited to, an appropriately sized catch basin with sump, pretreatment catchment device and a Jellyfish filter. Installation, operation, and maintenance of these devices shall be in accordance with manufacturer's recommendations. With this in place, most of the suspended solids captured on the site will be settle into the Jellyfish filter. The pretreatment structures shall be inspected for any debris that will restrict inlet flow rates. Outfall structures such as orifice tube must also be inspected for any obstructions that would restrict outlet flow rates. OSHA Guidelines must be followed when inspecting or cleaning any structure. This manual should be used in conjunction with but does not supersede local regulations or regulatory authorities.

Please refer to the Jellyfish filter Owner's Manual in the appendix for operations and maintenance details.

## **5. EROSION AND SEDIMENT CONTROL DURING CONSTRUCTION**

During Site construction, various temporary measures will be implemented to prevent the discharge of sediment laden Stormwater from the Site. These measures include silt fencing, catch basin silt-sacks and mud-mats, etc. as shown on Drg P-303 - Erosion Control Plan.

In addition to the above, the following "good housekeeping" measures are recommended:

- All exposed soil shall be stabilized as soon as possible with a seed and mulch application as directed by the Engineer.
- No construction activity or machinery shall intrude beyond the silt/snow fence or limit of construction area. All construction vehicles shall leave the site at designated locations as shown on the plans.
- Stockpiles of soil shall be set back from any watercourse and stabilized against erosion as soon as possible. A set back of at least 15m from any top-of-bank, watercourse or pond is required.
- Cleaning and repairs of mud-mats and any other temporary sediment control measures shall be completed as deemed necessary through regular inspection.
- Sediment/silt shall be removed from the sediment control devices after storm events and deposited in areas as approved by the engineer.

- All re-graded areas within the development which are not occupied by buildings, roadways, sidewalks, or driveways shall be top-soiled and sodded/seeded immediately after completion of final grading operations as directed by the engineer.

## 6. SUMMARY AND CONCLUSION

In summary, required conditions of the City of Ottawa have been satisfied as follows:

- The Stormwater flow from the Site is controlled to pre-development conditions.
- The proposed SWM facilities provide ENHANCED level of protection as specified by the Ministry of the Environment
- The proposed SWM techniques meet both quantity and quality requirements.
- The Sediment and Erosion Control Plan demonstrates how erosion and sedimentation will be minimized during construction

This SWM Report satisfies all requirements for stormwater quantity, quality, sedimentation, and erosion control.



James Sam, P.Eng  
Tel (416) 229-2636  
[j.sam@jandb-inc.com](mailto:j.sam@jandb-inc.com)



2180 Montreal Rd,  
Ottawa, ON

## Appendix A - GRADING PLAN

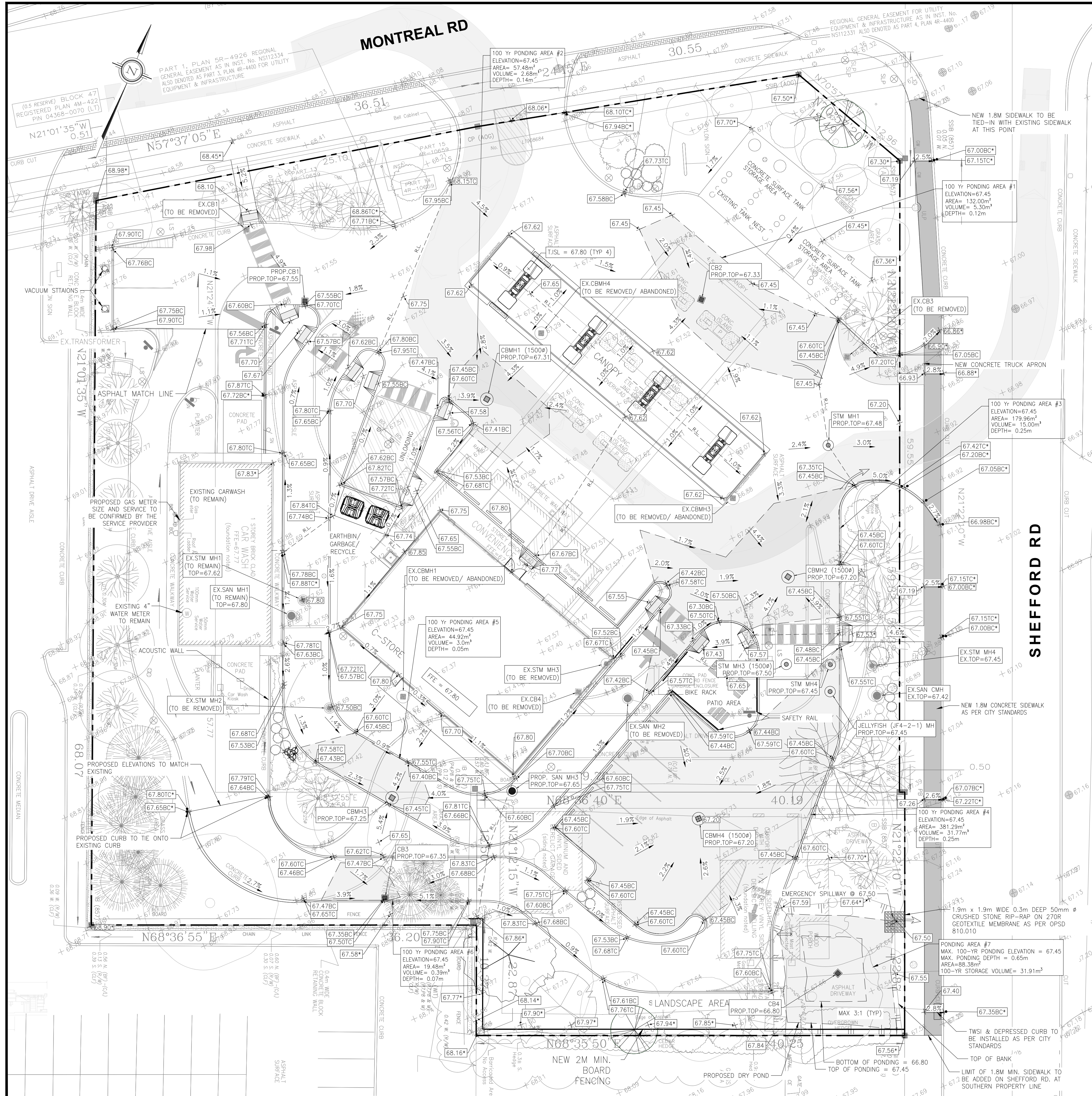

- GENERAL NOTES**
1. VERIFY ALL DIMENSIONS PRIOR TO CONSTRUCTION.
  2. DO NOT SCALE DRAWINGS.
  3. REPORT ALL DISCOVERIES OF ERRORS, OMISSIONS OR DISCREPANCIES TO THE DESIGN ENGINEER AS APPLICABLE.
  4. USE ONLY LATEST REVISED DRAWINGS OR THOSE THAT ARE MARKED "ISSUED FOR CONSTRUCTION".
  5. DESIGN AND CONSTRUCTION OF THIS PROJECT SHALL COMPLY WITH THE PROVINCIAL AND LOCAL BUILDING CODES LATEST EDITION.
  6. ALL WORKS AND MATERIALS USED SHALL COMPLY AS REQUIRED BY THE BUILDING CODE LATEST EDITION.
  7. THIS DRAWING SHALL BE READ IN CONJUNCTION WITH ALL RELEVANT DRAWINGS & SPECIFICATIONS.
  8. EVERYTHING IS TO BE CONSIDERED NEW UNLESS SPECIFIED OTHERWISE.

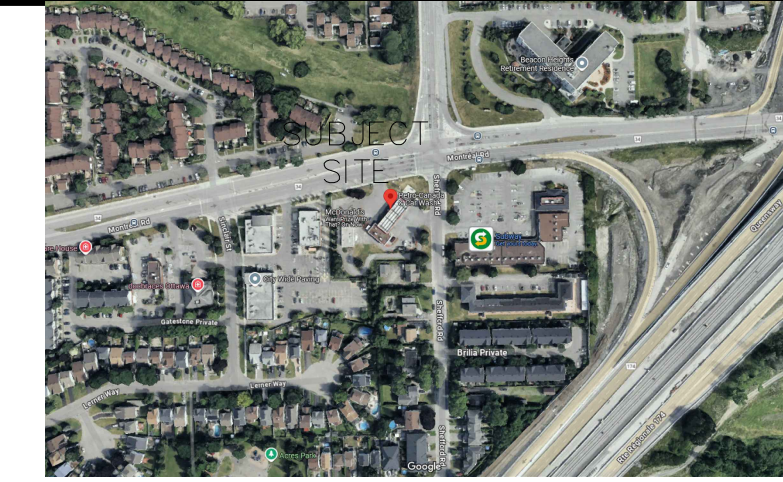

KEY PLAN  
NTS

PLAN OF SURVEY OF  
BLOCK 60 AND PART OF BLOCK 59  
REGISTERED PLAN 4M-916  
AND PART OF LOT 16  
CONCESSION 1 (OTTAWA FRONT)  
(GEOGRAPHIC TOWNSHIP OF GLOUCESTER)  
CITY OF OTTAWA

**BEARINGS**

BEARINGS SHOWN HEREON ARE GRID AND ARE REFERRED TO THE WESTERLY LIMIT OF SHEFFORD ROAD AS DERIVED FROM OBSERVED CONTROL POINTS "A" AND "B" AND HAVING A BEARING OF N 21°22'10" W.  
GRID BEARINGS ARE 3' MTM ZONE 09, CENTRAL MERIDIAN 76°30' WEST LONGITUDE, NAD83 (CSRS-2010.0).

**NOTES**

TREE CALIPER'S SHOWN HEREON ARE AS MEASURED BY OUR SURVEY CREW; CROWN DIMENSIONS ARE AS SHOWN ON THE FACE OF PLAN AND CONFIRMED VIA AERIAL REFERENCE DATA. THIS DATA HAS NOT BEEN CONFIRMED OR REVIEWED BY A PROFESSIONAL ARBORIST.

FENCES AND OCCUPATION ARE AS INDICATED ON THIS PLAN OF SURVEY.  
OBSERVATIONS TO STRUCTURES ON THE SUBJECT LANDS HAVE BEEN MADE TO THE EXPOSED EXTERIOR CLADDING OF THE STRUCTURES AS SHOWN.

**BEARING ROTATION:**

FOR BEARING COMPARISONS, A ROTATION OF 00°39'40" COUNTER-CLOCKWISE WAS APPLIED TO PLAN P3.

**BENCHMARK**

ELEVATIONS SHOWN HEREON ARE GEODETIC AND WERE DERIVED FROM GNSS OBSERVATIONS TO OUR CONTROL NETWORK. ELEVATIONS ARE REFERENCED TO OUR LOCAL BENCHMARK:

**LOCAL BENCHMARK:**

THE TOP NUT OF A FIRE HYDRANT LOCATED APPROXIMATELY 14m SOUTH OF DRIVEWAY ENTRANCE TO THE SUBJECT LANDS ALONG SHEFFORD ROAD AND HAVING AN ELEVATION OF 67.88. (NAD83; CSRS: v7-2010, GEOID MODEL HT2.0-2002.0)

**LEGEND**

- EXISTING ELEVATION
- EXISTING CATCHBASIN
- EXISTING C.B./M.H.
- EXISTING STM MANHOLE
- EXISTING SANITARY MANHOLE
- PROPOSED SLOPE
- FLUSH WITH FINISH GRADE ABOVE FINISH GRADE
- PROPOSED ELEVATION
- MATCH EXIST. ELEVATION
- PROP. ELE. (CURB TOP)
- PROP. ELE. (CURB BOTTOM)
- NEW CATCHBASIN
- NEW C.B./M.H.
- NEW SANITARY MANHOLE
- PROPERTY LINE
- RIDGE LINE
- OVERLAND FLOW
- SURFACE PONDING AREA

**REVISION TABLE**

REV.	DESCRIPTION	DRAWN	APP'D.	DATE
1	-	-	-	-

**ISSUE TABLE**

TO	FOR	DATE
SUNCOR	ISSUED FOR REVIEW	16 MAR '26
SUNCOR	ISSUED FOR REVIEW	31 MAR '26

**METRIC**  
ALL DIMENSIONS ARE IN MILLIMETRES U.N.O. CONTRACTOR TO CHECK/VERIFY ALL DIMENSIONS PRIOR TO COMMENCEMENT OF WORK. ALL DISCREPANCIES TO BE REPORTED TO THE PROJECT DESIGNER. DO NOT SCALE DRAWINGS.

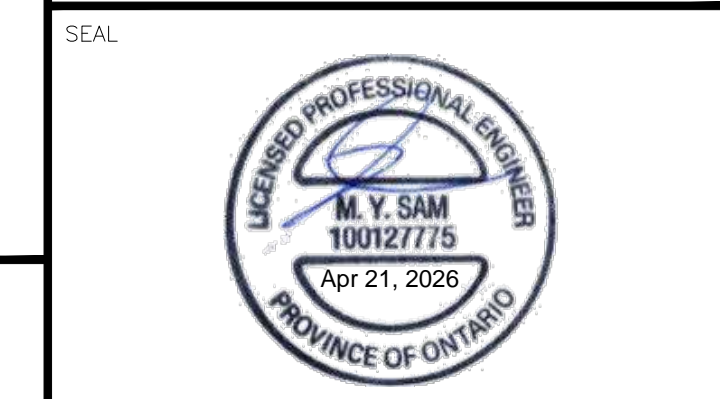

CONSULTANT

**J + B ENGINEERING INC.**  
TORONTO: 25 CHESTERMAN DR. CALGARY: 5301 STEELES AVE. SW  
SUITE 201 SUITE 200  
MARIPOSA, ON L3R 9N8 CALGARY, AB T2R 1E2  
416 229 2908 403 555 2256

**PETRO-CANADA**  
A Suncor Energy Business

DRAWING TITLE:  
**SITE GRADING PLAN**

PROJECT:  
**2180 MONTREAL RD  
@SHEFFORD RD  
OTTAWA, ON**

DRAWN BY: EM	CAD INFO.: SHEET SIZE D (559 x 864)
DRAWING SCALE: 1:200	CONSULTANT: PETRO-CANADA
DATE DRAWN: DEC 03 '25	PLOT SCALE: 1:1
CHECKED BY:	PLOT DATE
APPROVED BY:	PLOT CONFIGURATION
STD No./OUTLET No. 65004	SHEET No. P300



2180 Montreal Rd,  
Ottawa, ON

## Appendix B – ESC PLAN

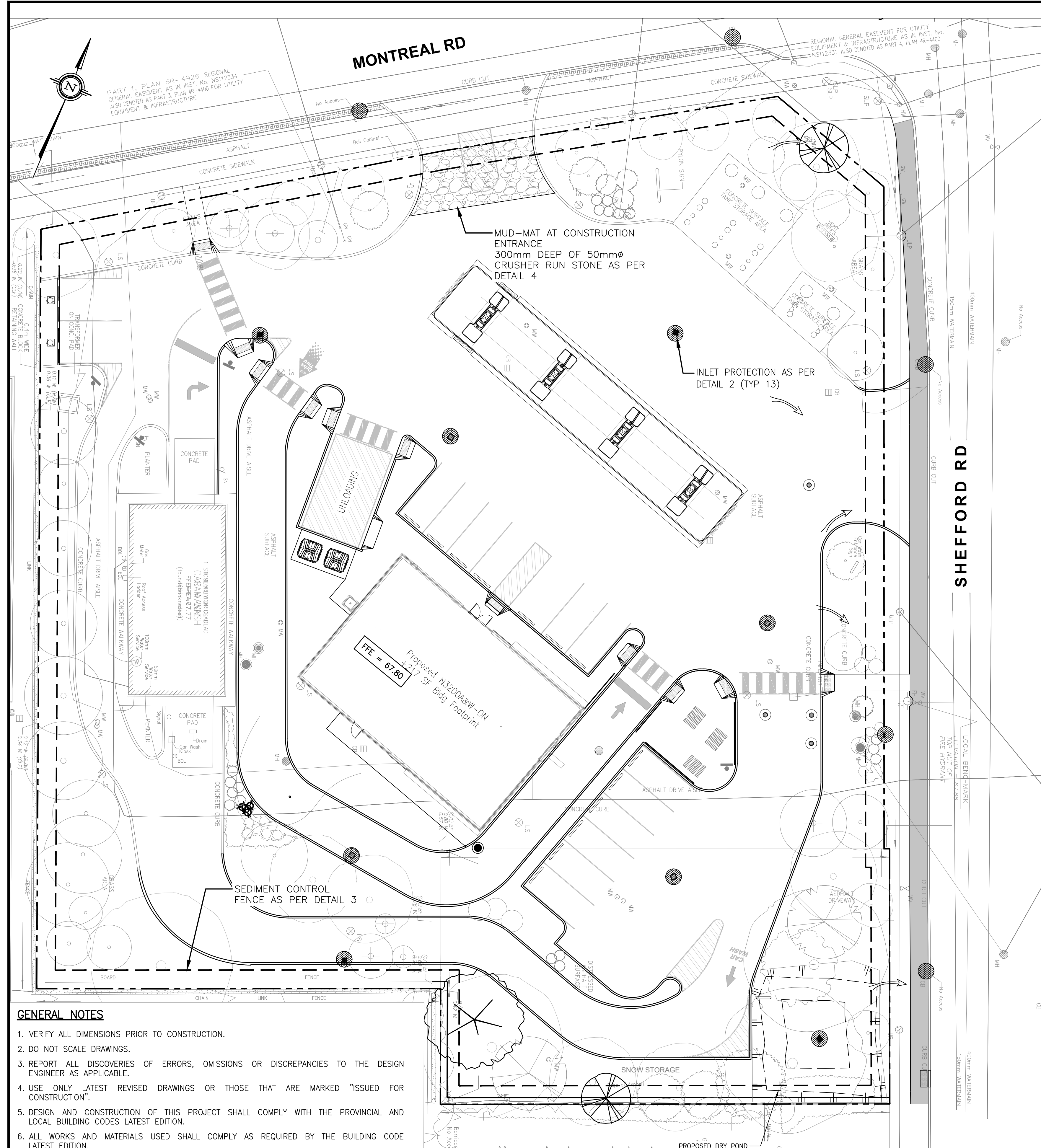

**GENERAL NOTES**

1. VERIFY ALL DIMENSIONS PRIOR TO CONSTRUCTION.
2. DO NOT SCALE DRAWINGS.
3. REPORT ALL DISCOVERIES OF ERRORS, OMISSIONS OR DISCREPANCIES TO THE DESIGN ENGINEER AS APPLICABLE.
4. USE ONLY LATEST REVISED DRAWINGS OR THOSE THAT ARE MARKED "ISSUED FOR CONSTRUCTION".
5. DESIGN AND CONSTRUCTION OF THIS PROJECT SHALL COMPLY WITH THE PROVINCIAL AND LOCAL BUILDING CODES LATEST EDITION.
6. ALL WORKS AND MATERIALS USED SHALL COMPLY AS REQUIRED BY THE BUILDING CODE LATEST EDITION.
7. THIS DRAWING SHALL BE READ IN CONJUNCTION WITH ALL RELEVANT DRAWINGS & SPECIFICATIONS.
8. EVERYTHING IS TO BE CONSIDERED NEW UNLESS SPECIFIED EXISTING OTHERWISE.

**1 EROSION AND SEDIMENT CONTROL PLAN**  
P-303 SCALE: 1:200

**EROSION & SEDIMENT CONTROL NOTES:**

1. THE OWNER IS RESPONSIBLE FOR OBTAINING ALL NECESSARY APPROVALS FROM THE CITY AND EXTERNAL AGENCIES PRIOR TO ANY SITE ALTERATION ACTIVITY.
2. PRIOR TO COMMENCEMENT OF ANY ON-SITE WORK/SOIL STRIPPING, EROSION AND SEDIMENT CONTROL (ESC) MEASURES, AS PER ACCEPTED SITE ALTERATION PLANS, MUST BE INSTALLED AND APPROVED BY THE DIRECTOR OF ENGINEERING. ADDITIONAL ESC MEASURES, IF REQUIRED, SHALL BE INSTALLED AS DIRECTOR OF ENGINEERING. THE ESC MEASURES SHALL REMAIN IN PLACE UNTIL DIRECTOR OF ENGINEERING FOR THEIR REMOVAL.
3. TREES ARE TO BE PRESERVED AS PER THE ACCEPTED TREE PRESERVATION PLANS.
4. NO CONSTRUCTION ACTIVITIES OR MACHINERY SHALL BE ALLOWED BEYOND THE SILT/SNOW FENCE OR LIMITS OF THE SUBDIVISION.
5. THE CONTRACTOR IS RESPONSIBLE TO IMPLEMENT DUST CONTROL MEASURES AND CONSTRUCTION PRACTICE GUIDELINES AS APPROVED BY THE CITY.
6. THE CONTRACTOR IS RESPONSIBLE FOR MAINTAINING ALL ESC MEASURES IN WORKING CONDITION AT ALL TIMES TO THE SATISFACTION OF THE DIRECTOR OF ENGINEERING. THE CONTRACTOR SHALL ROUTINELY INSPECT ALL ESC MEASURES AT A MINIMUM OF ONCE A WEEK AND AFTER EACH RAINFALL EVENT GREATER THAN 10mm TO ENSURE THE ESC MEASURES ARE IN PROPER WORKING CONDITIONS. ANY DAMAGES MUST BE REPAIRED WITHIN 24 HOURS.
7. ALL CONSTRUCTION VEHICLES MUST ENTER AND EXIT THE SITE ONLY FROM THE APPROVED ACCESS ROUTE(S) AS SHOWN ON THE ACCEPTED SITE ALTERATION PLANS.
8. CATCHBASIN SEDIMENT CONTROL MEASURES ARE TO BE INSTALLED IMMEDIATELY AFTER INSTALLATION OF CATCHBASINS.
9. ALL DISTURBED GROUND LEFT INACTIVE FOR OVER 30 DAYS SHALL BE VEGETATED, SUBJECT TO WEATHER CONDITIONS, BY SEEDING OR APPROVED EQUIVALENT TO THE SATISFACTION OF THE DIRECTOR OF ENGINEERING.
10. ALL SOIL STOCKPILES IF REMAINING ON SITE FOR MORE THAN 30 DAYS SHALL BE VEGETATED, SUBJECT TO WEATHER CONDITIONS, BY SEEDING OR APPROVED EQUIVALENT TO THE SATISFACTION OF THE DIRECTOR OF ENGINEERING.
11. STREET SWEEPING/CATCHBASIN CLEANING PROGRAM SHALL BE IMPLEMENTED UPON COMPLETION OF BASE ASPHALT TO THE SATISFACTION OF THE DIRECTOR OF ENGINEERING.
12. ALL SOIL STOCKPILES SHALL BE SURROUNDED WITH SEDIMENT CONTROL FENCE. THE MAXIMUM SIDE SLOPES FOR STOCKPILES SHALL BE 1.5 (H) TO 1.0 (V). THE MAXIMUM HEIGHT OF STOCKPILE SHALL NOT EXCEED 3.0 m.
13. THE CONTRACTOR SHALL ENDEAVOR TO PREVENT MUD TRUCKING ONTO EXISTING RIGHT-OF-WAY AND SHALL PROVIDE CLEAN UP AT HIS/HER OWN EXPENSE AS DIRECTED BY THE DIRECTOR OF ENGINEERING.
14. THE CONTRACTOR SHALL CARE AND CONTROL SPILLS, FLUIDS, AND MATERIALS DURING CONSTRUCTION TO MINIMIZE RISK TO THE ENVIRONMENT.

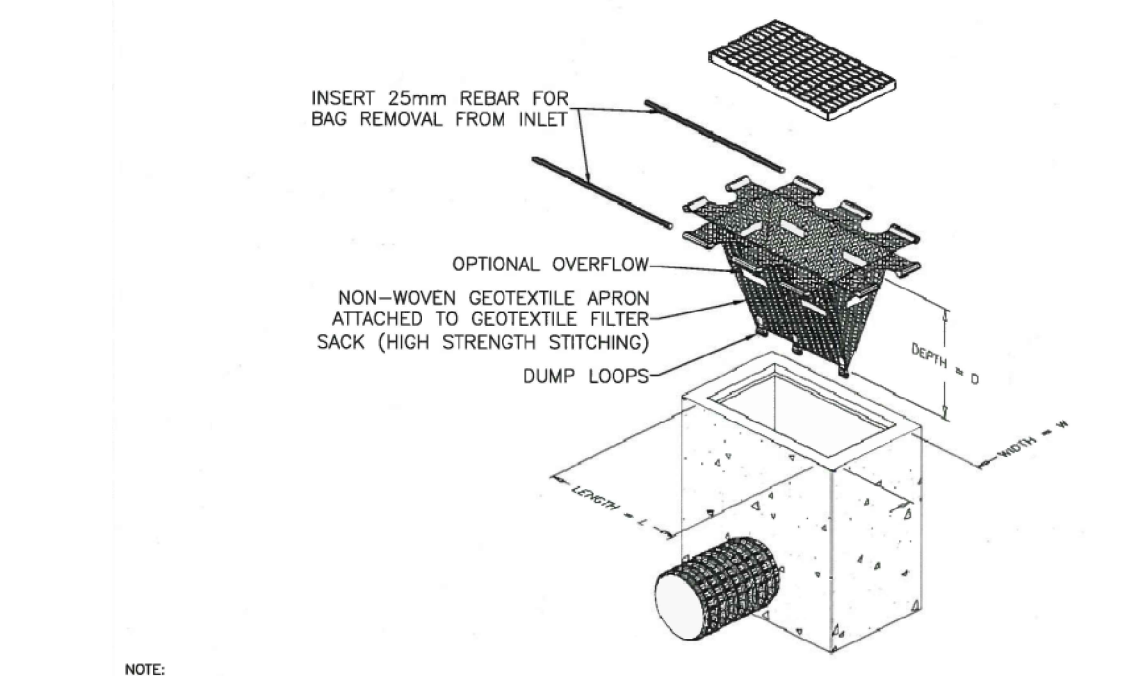

**2 TYP. CATCHBASIN SEDIMENT PROTECTION DETAIL**  
P-303 SCALE: NTS

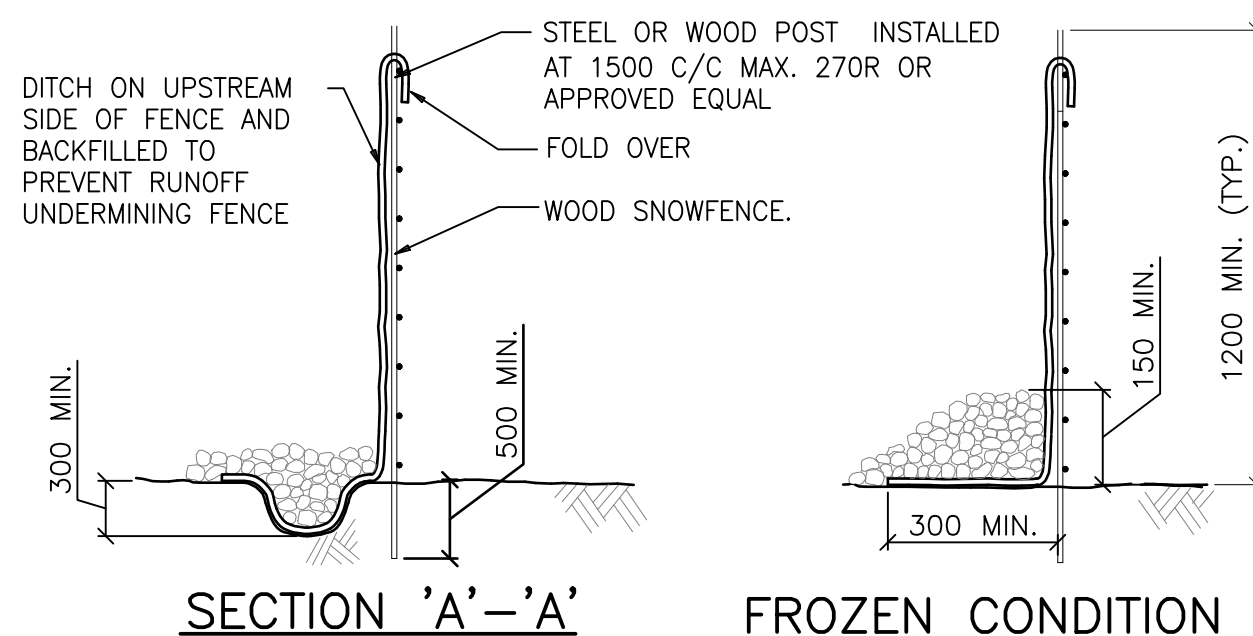
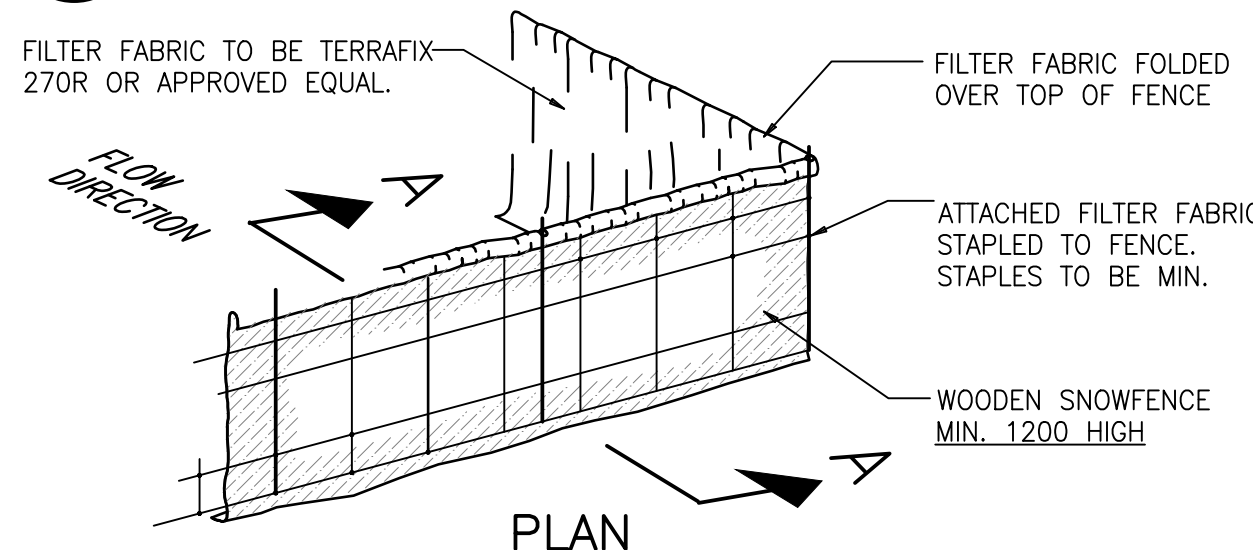

**3 SEDIMENT CONTROL FENCE**  
P-303 SCALE: NTS

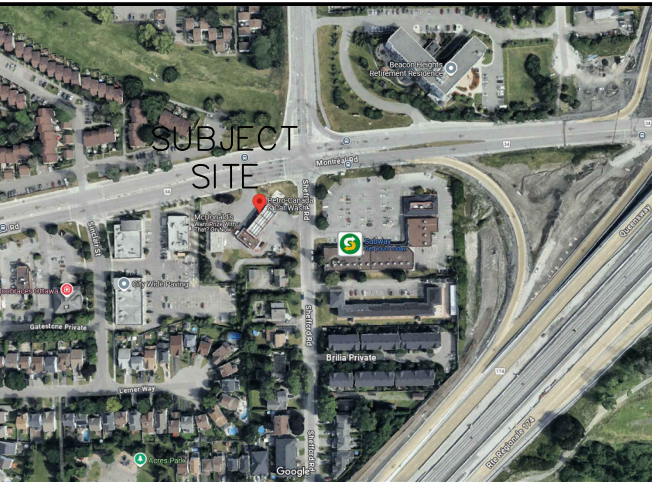

**KEY PLAN**  
NTS

**PLAN OF SURVEY OF**  
BLOCK 60 AND PART OF BLOCK 59  
REGISTERED PLAN 4M-916  
AND PART OF LOT 16  
CONCESSION 1 (OTTAWA FRONT)  
(GEOGRAPHIC TOWNSHIP OF GLOUCESTER)  
CITY OF OTTAWA

**BEARING**  
BEARINGS SHOWN HEREON ARE GRID AND ARE REFERRED TO THE WESTERLY LIMIT OF SHEFFORD ROAD AS DERIVED FROM OBSERVED CONTROL POINTS 'A' AND 'B' AND HAVING A BEARING OF N 21°22'10" W.  
GRID BEARINGS ARE 3' MTM ZONE 09, CENTRAL MERIDIAN 76°30' WEST LONGITUDE, NAD83 (CSRS-2010.0).

**NOTES**  
TREE CALIPER'S SHOWN HEREON ARE AS MEASURED BY OUR SURVEY CREW; CROWN DIMENSIONS ARE AS SHOWN ON THE FACE OF PLAN AND CONFIRMED VIA AERIAL REFERENCE DATA. THIS DATA HAS NOT BEEN CONFIRMED OR REVIEWED BY A PROFESSIONAL ARBORIST.

FENCES AND OCCUPATION ARE AS INDICATED ON THIS PLAN OF SURVEY.  
OBSERVATIONS TO STRUCTURES ON THE SUBJECT LANDS HAVE BEEN MADE TO THE EXPOSED EXTERIOR CLADDING OF THE STRUCTURES AS SHOWN.

**BEARING ROTATION:**  
FOR BEARING COMPARISONS, A ROTATION OF 00°39'40" COUNTER-CLOCKWISE WAS APPLIED TO PLAN P3.

**BENCHMARK**  
ELEVATIONS SHOWN HEREON ARE GEODETIC AND WERE DERIVED FROM GNSS OBSERVATIONS TO OUR CONTROL NETWORK. ELEVATIONS ARE REFERENCED TO OUR LOCAL BENCHMARK:

**LOCAL BENCHMARK:**  
THE TOP NUT OF A FIRE HYDRANT LOCATED APPROXIMATELY 14m SOUTH OF DRIVEWAY ENTRANCE TO THE SUBJECT LANDS ALONG SHEFFORD ROAD AND HAVING AN ELEVATION OF 67.88. (NAD83; CSRS: v7-2010, GEOD MODEL HT2.0-2002.0)

**LEGEND**

- EXISTING CATCHBASIN
- EXISTING MANHOLE
- NEW SANITARY MANHOLE
- NEW CATCHBASIN
- NEW C.B./M.H.
- NEW STORM MANHOLE
- PROPERTY LINE
- OVERLAND FLOW
- INLET PROTECTION
- SILT FENCE

REVISION TABLE		
REV.	DESCRIPTION	DRAWN APP'D. DATE
1		

ISSUE TABLE		
TO	FOR	DATE
SUNCOR	ISSUED FOR REVIEW	16 MAR '26

**METRIC**  
ALL DIMENSIONS ARE IN MILLIMETRES U.N.O. CONTRACTOR TO CHECK/VERIFY ALL DIMENSIONS PRIOR TO COMMENCEMENT OF WORK. ALL DISCREPANCIES TO BE REPORTED TO THE PROJECT DESIGNER. DO NOT SCALE DRAWINGS.



**CONSULTANT**

**J + B ENGINEERING INC.**  
TORONTO: 25 GERRARD ST. E. SUITE 201, WILLOWDALE, ON L3R 9N8, 416 229 2908  
CALGARY: 60411TH AVE. SW. SUITE 200, CALGARY, AB T2R 0E2, 403 555 2256



DRAWING TITLE:

**EROSION AND SEDIMENT CONTROL PLAN**

PROJECT:  
2180 MONTREAL RD  
@SHEFFORD RD  
OTTAWA, ON

DRAWN BY: EM	CAD INFO.: SHEET SIZE D (559 x 864)
DRAWING SCALE: 1:200	CONSULTANT: PETRO-CANADA
DATE DRAWN: DEC 03 '25	PROJECT: 250344-P-303
CHECKED BY:	PLOT SCALE: 1:1
APPROVED BY:	PLOT CONFIGURATION
STD No./OUTLET No. 65004	SHEET No. P303



2180 Montreal Rd,  
Ottawa, ON

## Appendix C – SITE SERVICING PLAN

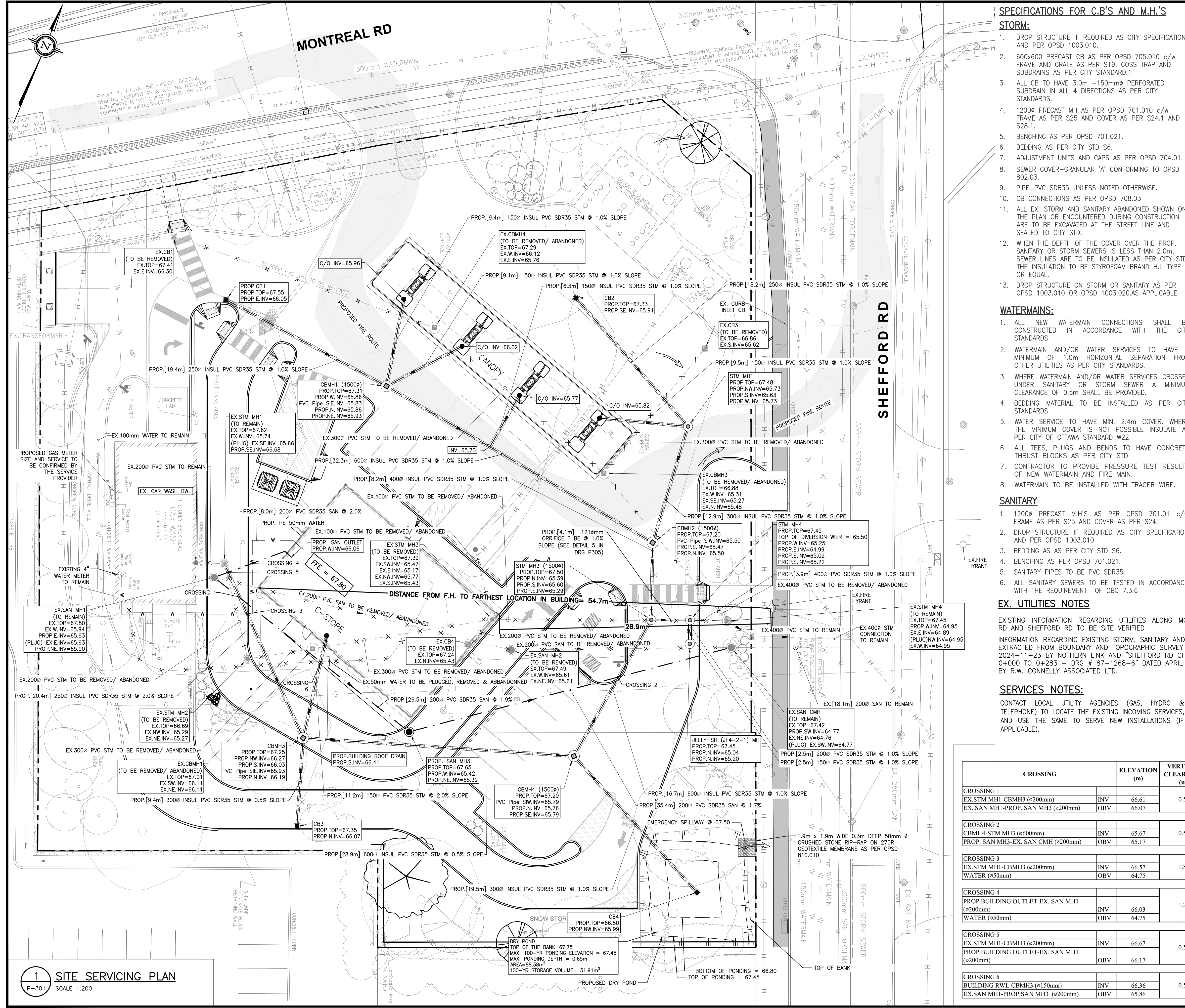

**SPECIFICATIONS FOR C.B.'S AND M.H.'S**

**STORM:**

- DROP STRUCTURE IF REQUIRED AS CITY SPECIFICATION AND PER OPSD 1003.010.
- 600x600 PRECAST CB AS PER OPSD 705.010 c/w FRAME AND GRATE AS PER S19. GOSS TRAP AND SUBDRAINS AS PER CITY STANDARD.1
- ALL CB TO HAVE 3.0m -150mm PERFORATED SUBDRAIN IN ALL 4 DIRECTIONS AS PER CITY STANDARDS.
- 1200 PRECAST MH AS PER OPSD 701.010 c/w FRAME AS PER S25 AND COVER AS PER S24.1 AND S28.1.
- BENCHING AS PER OPSD 701.021.
- BEDDING AS PER CITY STD S6.
- ADJUSTMENT UNITS AND CAPS AS PER OPSD 704.01.
- SEWER COVER-GRANULAR 'A' CONFORMING TO OPSD 802.03.
- PIPE-PVC SDR35 UNLESS NOTED OTHERWISE.
- CB CONNECTIONS AS PER OPSD 708.03
- ALL EX. STORM AND SANITARY ABANDONED SHOWN ON THE PLAN OR ENCOUNTERED DURING CONSTRUCTION ARE TO BE EXCAVATED AT THE STREET LINE AND SEALED TO CITY STD.
- WHEN THE DEPTH OF THE COVER OVER THE PROP. SANITARY OR STORM SEWERS IS LESS THAN 2.0m, SEWER LINES ARE TO BE INSULATED AS PER CITY STD. THE INSULATION TO BE STYROFOAM BRAND H.I. TYPE IV OR EQUAL.
- DROP STRUCTURE ON STORM OR SANITARY AS PER OPSD 1003.010 OR OPSD 1003.020 AS APPLICABLE

**WATERMAINS:**

- ALL NEW WATERMAIN CONNECTIONS SHALL BE CONSTRUCTED IN ACCORDANCE WITH THE CITY STANDARDS.
- WATERMAIN AND/OR WATER SERVICES TO HAVE A MINIMUM OF 1.0m HORIZONTAL SEPARATION FROM OTHER UTILITIES AS PER CITY STANDARDS.
- WHERE WATERMAIN AND/OR WATER SERVICES CROSSES UNDER SANITARY OR STORM SEWER A MINIMUM CLEARANCE OF 0.5m SHALL BE PROVIDED.
- BEDDING MATERIAL TO BE INSTALLED AS PER CITY STANDARDS.
- WATER SERVICE TO HAVE MIN. 2.4m COVER. WHERE THE MINIMUM COVER IS NOT POSSIBLE INSULATE AS PER CITY OF OTTAWA STANDARD W22
- ALL TEES, PLUGS AND BENDS TO HAVE CONCRETE THRUST BLOCKS AS PER CITY STD
- CONTRACTOR TO PROVIDE PRESSURE TEST RESULTS OF NEW WATERMAIN AND FIRE MAIN.
- WATERMAIN TO BE INSTALLED WITH TRACER WIRE.

**SANITARY**

- 1200 PRECAST M.H.'S AS PER OPSD 701.01 c/w FRAME AS PER S25 AND COVER AS PER S24.
- DROP STRUCTURE IF REQUIRED AS CITY SPECIFICATION AND PER OPSD 1003.010.
- BEDDING AS PER CITY STD S6.
- BENCHING AS PER OPSD 701.021.
- SANITARY PIPES TO BE PVC SDR35.
- ALL SANITARY SEWERS TO BE TESTED IN ACCORDANCE WITH THE REQUIREMENT OF OBC 7.3.6

**EX. UTILITIES NOTES**

EXISTING INFORMATION REGARDING UTILITIES ALONG MONTREAL RD AND SHEFFORD RD TO BE SITE VERIFIED

INFORMATION REGARDING EXISTING STORM, SANITARY AND WATER EXTRACTED FROM BOUNDARY AND TOPOGRAPHIC SURVEY DATED 2024-11-23 BY NOTHERN LINK AND "SHEFFORD RD CH 0+00 TO 0+283 - DRG # 87-1268-6" DATED APRIL 1988 BY R.W. CONNELLY ASSOCIATED LTD.

**SERVICES NOTES:**

CONTACT LOCAL UTILITY AGENCIES (GAS, HYDRO & TELEPHONE) TO LOCATE THE EXISTING INCOMING SERVICES, AND USE THE SAME TO SERVE NEW INSTALLATIONS (IF APPLICABLE).

CROSSING	ELEVATION (m)	VERTICAL CLEARANCE (m)
CROSSING 1 EX.STM MHI-CBMH3 (ø200mm) EX. SAN MHI-PROP. SAN MH3 (ø200mm)	INV 66.61 OBV 66.07	0.54
CROSSING 2 CBMH4-STM MH3 (ø600mm) PROP. SAN MH3-EX. SAN CMH (ø200mm)	INV 65.67 OBV 65.17	0.50
CROSSING 3 EX.STM MHI-CBMH3 (ø200mm) WATER (ø50mm)	INV 66.57 OBV 64.75	1.82
CROSSING 4 PROP.BUILDING OUTLET-EX. SAN MHI (ø200mm) WATER (ø50mm)	INV 66.03 OBV 64.75	1.28
CROSSING 5 EX.STM MHI-CBMH3 (ø200mm) PROP.BUILDING OUTLET-EX. SAN MHI (ø200mm)	INV 66.67 OBV 66.17	0.50
CROSSING 6 BUILDING RWL-CBMH3 (ø150mm) EX.SAN MHI-PROP.SAN MH3 (ø200mm)	INV 66.36 OBV 65.86	0.50

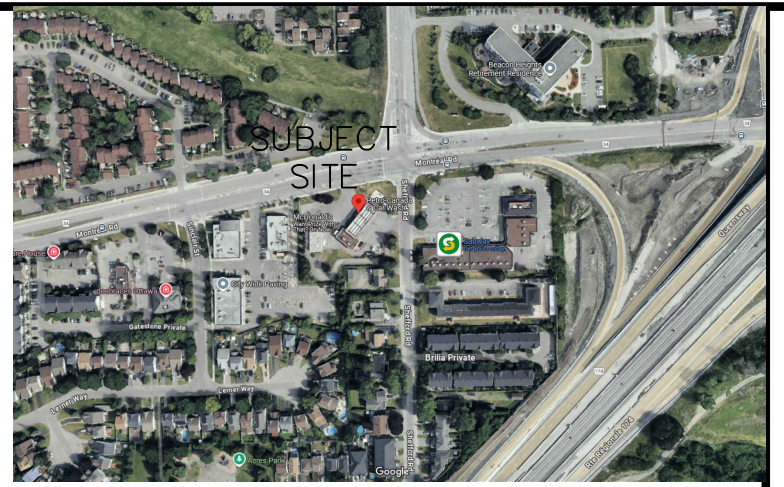

**KEY PLAN**  
NTS

**PLAN OF SURVEY OF**  
BLOCK 60 AND PART OF BLOCK 59  
REGISTERED PLAN 4M-916  
AND PART OF LOT 16  
CONCESSION 1 (OTTAWA FRONT)  
(GEOGRAPHIC TOWNSHIP OF GLOUCESTER)  
CITY OF OTTAWA

**BEARING**  
BEARINGS SHOWN HEREON ARE GRID AND ARE REFERRED TO THE WESTERLY LIMIT OF SHEFFORD ROAD AS DERIVED FROM OBSERVED CONTROL POINTS 'A' AND 'B' AND HAVING A BEARING OF N 21°22'10" W.  
GRID BEARINGS ARE 3' MTM ZONE 09, CENTRAL MERIDIAN 76°30' WEST LONGITUDE, NAD83 (CSRS-2010.0).

**NOTES**  
TREE CALIPER'S SHOWN HEREON ARE AS MEASURED BY OUR SURVEY CREW; CROWN DIMENSIONS ARE AS SHOWN ON THE FACE OF PLAN AND CONFIRMED VIA AERIAL REFERENCE DATA. THIS DATA HAS NOT BEEN CONFIRMED OR REVIEWED BY A PROFESSIONAL ARBORIST.

**ISSUE TABLE**

TO	FOR	DATE
SUNCOR	ISSUED FOR REVIEW	16 MAR '26
SUNCOR	ISSUED FOR REVIEW	31 MAR '26

**BEARING ROTATION:**  
FOR BEARING COMPARISONS, A ROTATION OF 00°39'40" COUNTER-CLOCKWISE WAS APPLIED TO PLAN P3.

**BENCHMARK**  
ELEVATIONS SHOWN HEREON ARE GEODETIC AND WERE DERIVED FROM GNSS OBSERVATIONS TO OUR CONTROL NETWORK. ELEVATIONS ARE REFERENCED TO OUR LOCAL BENCHMARK:

**LOCAL BENCHMARK:**  
THE TOP NUT OF A FIRE HYDRANT LOCATED APPROXIMATELY 14m SOUTH OF DRIVEWAY ENTRANCE TO THE SUBJECT LANDS ALONG SHEFFORD ROAD AND HAVING AN ELEVATION OF 67.88. (NAD83; CSRS; v7-2010, GEOID MODEL HT2.0-2002.0)

**LEGEND**

- EXISTING CATCHBASIN
- EXISTING C.B./M.H.
- EXISTING STM MANHOLE
- EXISTING SANITARY MANHOLE
- EXISTING WATER LINE
- EXISTING STORM LINE
- EXISTING SANITARY LINE
- NEW CATCHBASIN
- NEW C.B./M.H.
- NEW SANITARY MANHOLE
- NEW STM MANHOLE
- PROPERTY LINE
- OVERLAND FLOW
- REMOVALS
- PROPOSED STORM SEWER
- PROPOSED SANITARY SEWER
- PROPOSED WATER
- INSULATED PIPE
- OVERLAND FLOW ROUTE

**REVISION TABLE**

REV.	DESCRIPTION	DATE	DRAWN	APP'D.
0			SR	JS
				31 MAR '26

**ISSUE TABLE**

TO	FOR	DATE
SUNCOR	ISSUED FOR REVIEW	16 MAR '26
SUNCOR	ISSUED FOR REVIEW	31 MAR '26

**METRIC**  
ALL DIMENSIONS ARE IN MILLIMETRES U.N.O. CONTRACTOR TO CHECK/VERIFY ALL DIMENSIONS PRIOR TO COMMENCEMENT OF WORK. ALL DISCREPANCIES TO BE REPORTED TO THE PROJECT DESIGNER. DO NOT SCALE DRAWINGS.

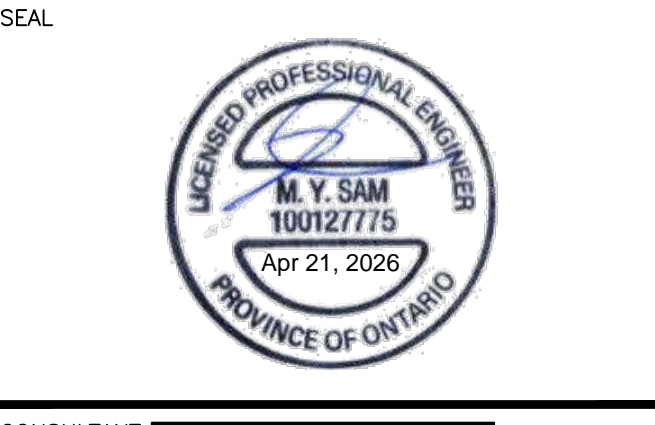

**CONSULTANT**

J + B ENGINEERING INC.  
TORONTO: 28 GERRARD ST. E. SUITE 201  
CALGARY: 6041 17TH AVE. SW. SUITE 200  
VANCOUVER: 400 WEST 1ST AVE. SUITE 200  
416 229 2908



**DRAWING TITLE:**  
**SITE SERVICING PLAN**

**PROJECT:**  
2180 MONTREAL RD  
@SHEFFORD RD  
OTTAWA, ON

DRAWN BY: EM	CAD INFO: SHEET SIZE D (559 x 864)
DRAWING SCALE: 1:200	PETRO-CANADA
DATE DRAWN: DEC 03 '25	CONSULTANT 250344-P-301
CHECKED BY:	PLOT SCALE 1:1
APPROVED BY:	PLOT DATE
STD No./OUTLET No. 65004	PLOT CONFIGURATION
	SHEET No. P301



2180 Montreal Rd,  
Ottawa, ON

## Appendix D – JELLYFISH FILTER OWNER'S MANUAL

# *Jellyfish*<sup>®</sup> Filter **Owner's Manual**

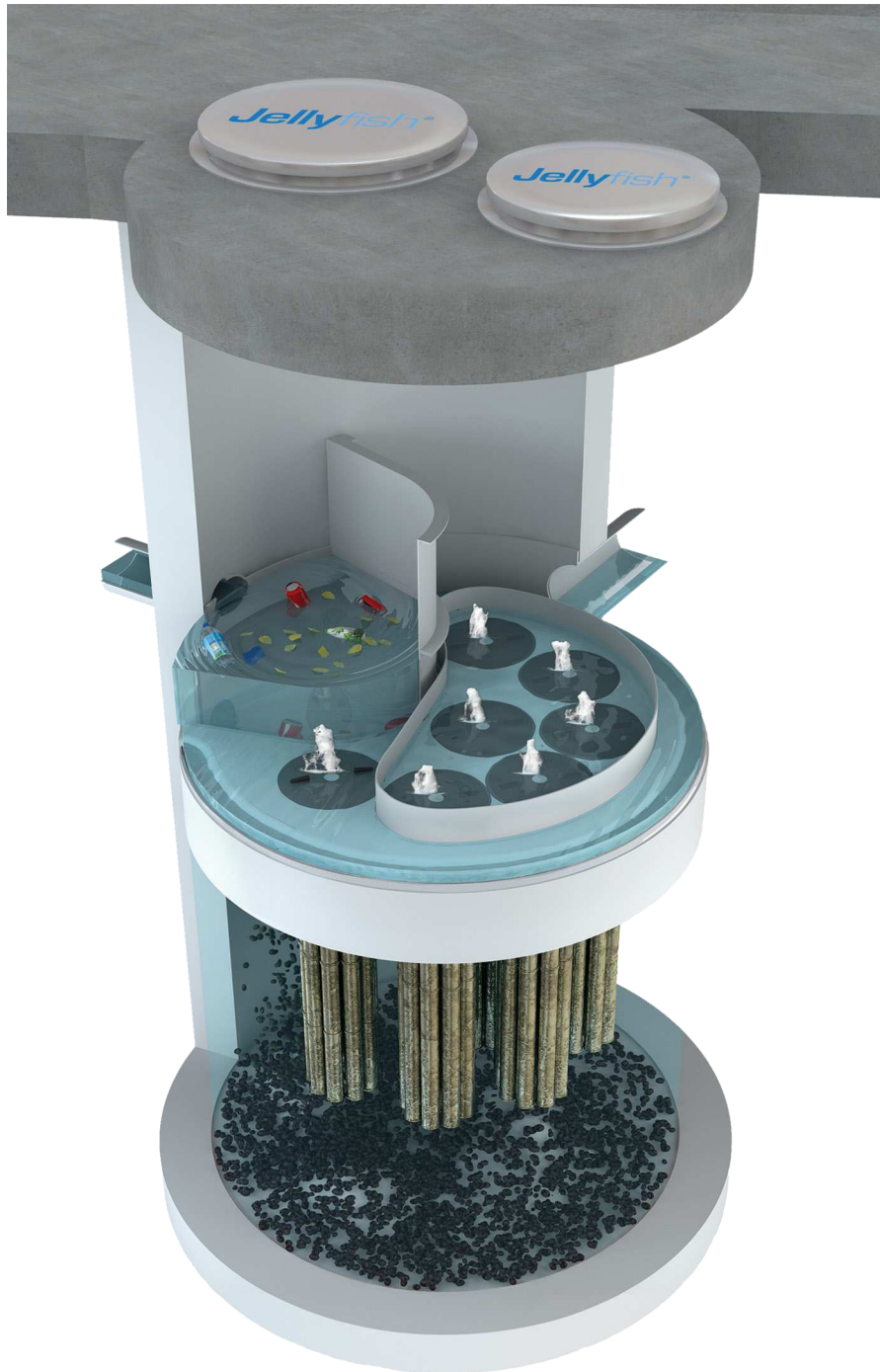

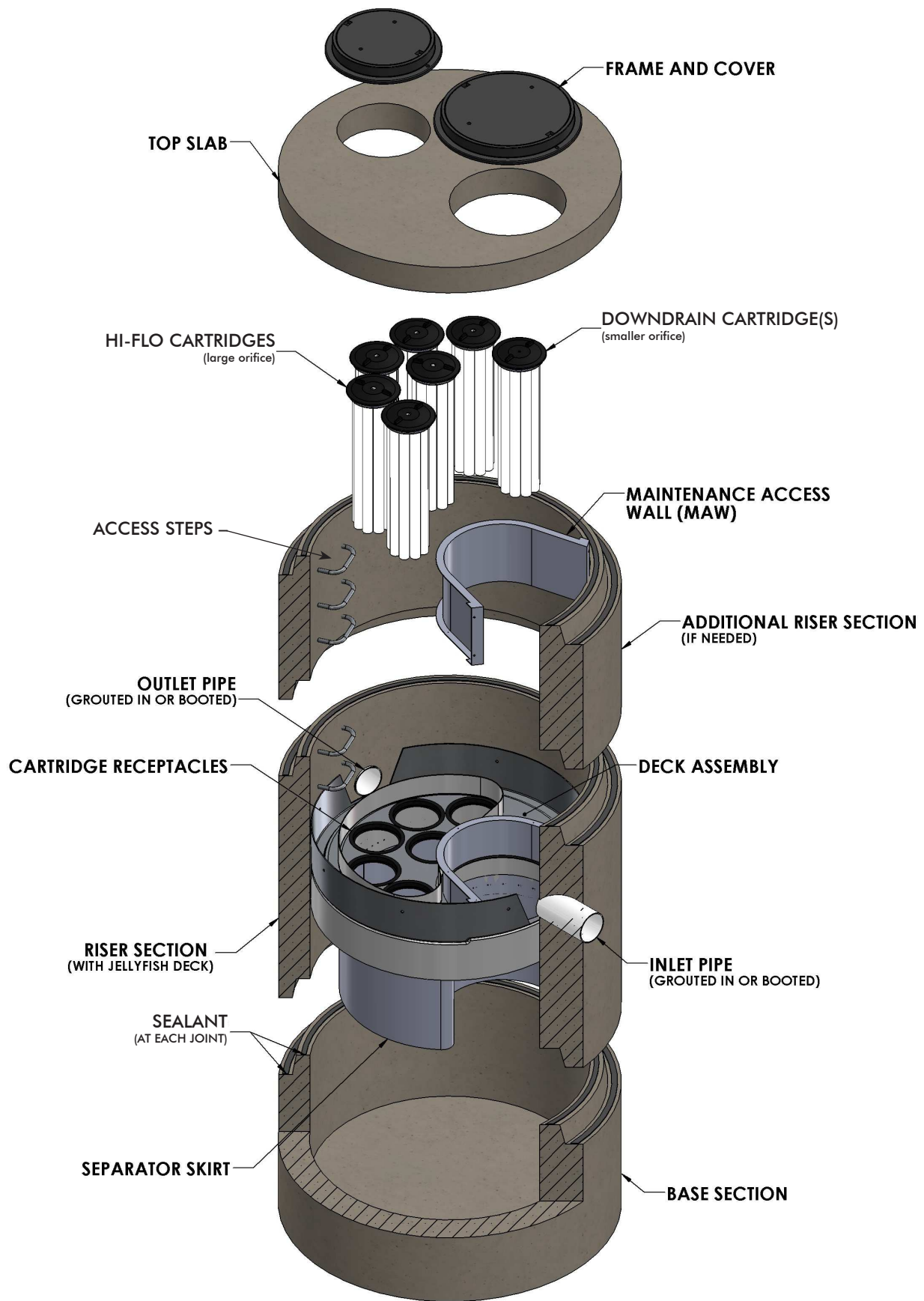

## WARNINGS / CAUTION

1. FALL PROTECTION may be required.
2. WATCH YOUR STEP if standing on the Jellyfish Filter Deck at any time; Great care and safety must be taken while walking or maneuvering on the Jellyfish Filter Deck. Attentive care must be taken while standing on the Jellyfish Filter Deck at all times to prevent stepping onto a lid, into or through a cartridge hole or slipping on the deck.
3. The Jellyfish Filter Deck can be SLIPPERY WHEN WET.
4. If the Top Slab, Covers or Hatches have not yet been installed, or are removed for any reason, great care must be taken to NOT DROP ANYTHING ONTO THE JELLYFISH FILTER DECK. The Jellyfish Filter Deck and Cartridge Receptacle Rings can be damaged under high impact loads. *This type of activity voids all warranties. All damaged items to be replaced at owner's expense.*
5. Maximum deck load 2 persons, total weight 250 lbs. per person.

## Safety Notice

Jobsite safety is a topic and practice addressed comprehensively by others. The inclusions here are intended to be reminders to whole areas of Safety Practice that are the responsibility of the Owner(s), Manager(s) and Contractor(s). OSHA and Canadian OSH, and Federal, State/Provincial, and Local Jurisdiction Safety Standards apply on any given site or project. The knowledge and applicability of those responsibilities is the Contractor's responsibility and outside the scope of Imbrium® Systems.

## Confined Space Entry

Secure all equipment and perform all training to meet applicable local and OSHA regulations regarding confined space entry. It is the Contractor's or entry personnel's responsibility to proceed safely at all times.

## Personal Safety Equipment

Contractor is responsible to provide and wear appropriate personal protection equipment as needed including, but not limited to safety boots, hard hat, reflective vest, protective eyewear, gloves and fall protection equipment as necessary. Make sure all equipment is **staffed with trained and/or certified personnel**, and all equipment is checked for proper operation and safety features prior to use.

- Fall protection equipment
- Eye protection
- Safety boots
- Ear protection
- Gloves
- Ventilation and respiratory protection
- Hard hat
- Maintenance and protection of traffic plan

## Thank You for purchasing the Jellyfish® Filter!

Imbrium® Systems would like to thank you for selecting the Jellyfish Filter to meet your project's stormwater treatment needs. With proper inspection and maintenance, the Jellyfish Filter is designed to deliver ongoing, high levels of stormwater pollutant removal.

If you have any questions, please feel free to call us or e-mail us at [info@imbriumsystems.com](mailto:info@imbriumsystems.com).

### Imbrium Systems

USA: 301.279.8827 | 888.279.8826

CAD: 416.960.9900 | 800.565.4801

INT'L: +1.416.960.9900

## Jellyfish Filter Patents

The Jellyfish Filter is protected by one or more of the following patents:

U.S. Patent No. 8,123,935; U.S. Patent No. 8,287,726; U.S. Patent No. 8,221,618

Australia Patent No. 2008,286,748

Canadian Patent No. 2,696,482

Korean Patent No. 10-1287539

New Zealand Patent No. 583,461; New Zealand Patent No. 604,227

South African Patent No. 2010,01068

*\*other patents pending*

# Table of Contents

<b>Chapter 1</b>		
	1.0 Owner Specific Jellyfish Product Information	6
<b>Chapter 2</b>		
	2.0 Jellyfish Filter System Operations & Functions	7
	2.1 Components & Cartridges	8
	2.2 Jellyfish Membrane Filtration Cartridges Assembly	9
	2.3 Installation of Jellyfish Membrane Filtration Cartridges	9
<b>Chapter 3</b>		
	3.0 Inspection and Maintenance Overview	10
	3.1 Inspection	10
	3.2 Maintenance	14
	3.3 Disposal Procedures	15
<b>Chapter 4</b>		
	4.0 Recommended Safety Procedures	15
	4.1 Confined Space/Personal Safety Equipment/Warnings and Caution	15
<b>Chapter 5</b>		
	5.0 Jellyfish Filter Replacement Parts	15
	5.1 Jellyfish Filter Replacement Parts List	15
<b>Forms</b>		
	Jellyfish Filter Inspection and Maintenance Log	16
<b>List of Figures</b>		
	Figure 1 – Jellyfish Filter Treatment Functions	7
	Figure 2 – Jellyfish Filter Components	8
	Figure 3 – Jellyfish Membrane Filtration Cartridge	9
<b>List of Tables</b>		
	Table 1 – Cartridge Lengths / Weights and Cartridge Lid Orifice Diameters	8



## Chapter 2

### 2.0 – Jellyfish Filter System Operations and Functions

The Jellyfish Filter is an engineered stormwater quality treatment technology that removes a high level and wide variety of stormwater pollutants. Each Jellyfish Filter cartridge consists of multiple membrane - encased filter elements (“filtration tentacles”) attached to a cartridge head plate. The filtration tentacles provide a large filtration surface area, resulting in high flow and high pollutant removal capacity.

The Jellyfish Filter functions are depicted in **Figure 1** below.

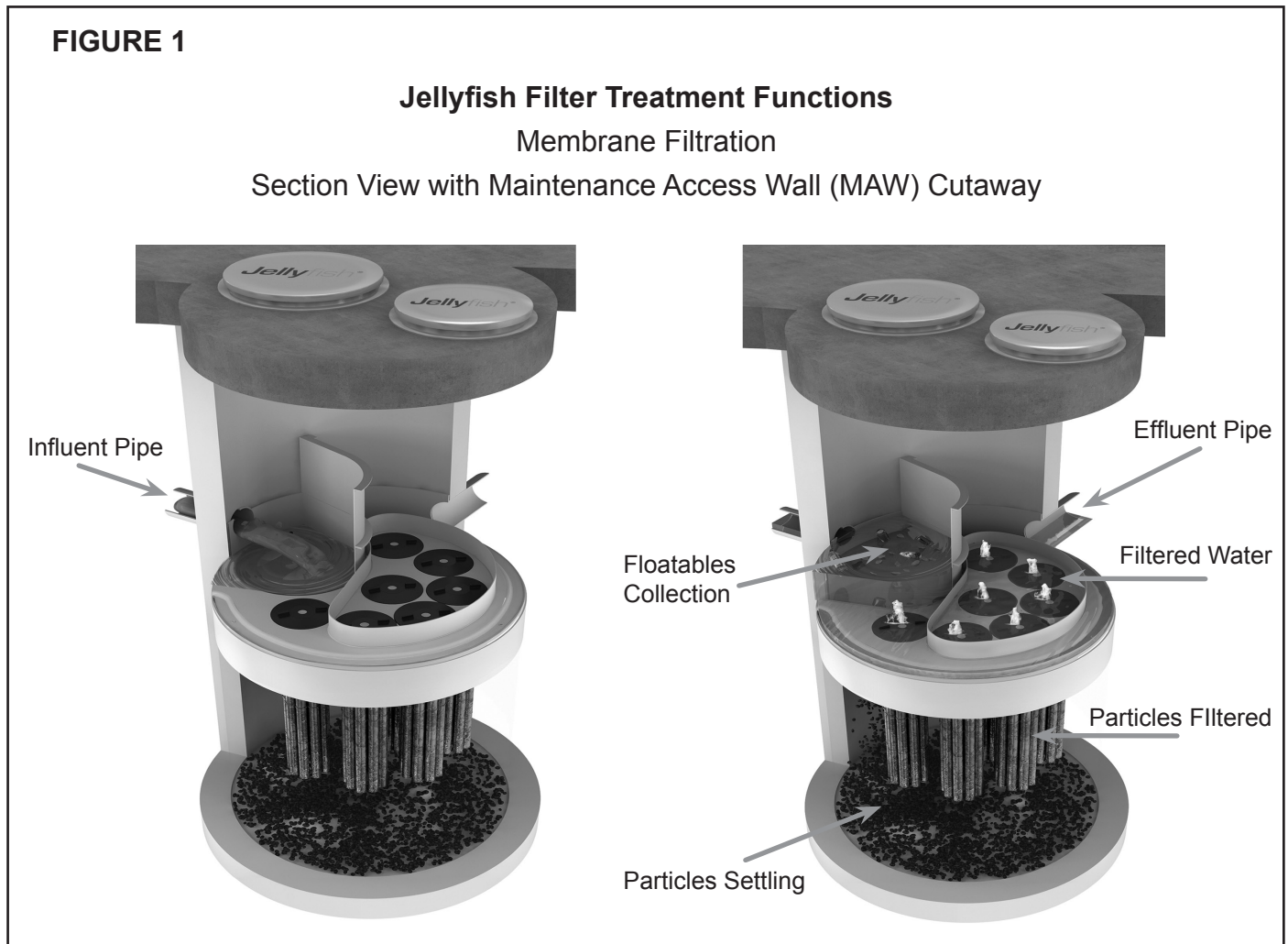

Jellyfish Filter cartridges are backwashed after each peak storm event, which removes accumulated sediment from the membranes. This backwash process extends the service life of the cartridges and increases the time between maintenance events.

For additional details on the operation and pollutant capabilities of the Jellyfish Filter please refer to additional details on our website at [www.imbriumsystems.com](http://www.imbriumsystems.com).

## 2.1 – Components and Cartridges

The Jellyfish Filter and components are depicted in Figure 2 below.

**FIGURE 2**

**Jellyfish Filter Components**

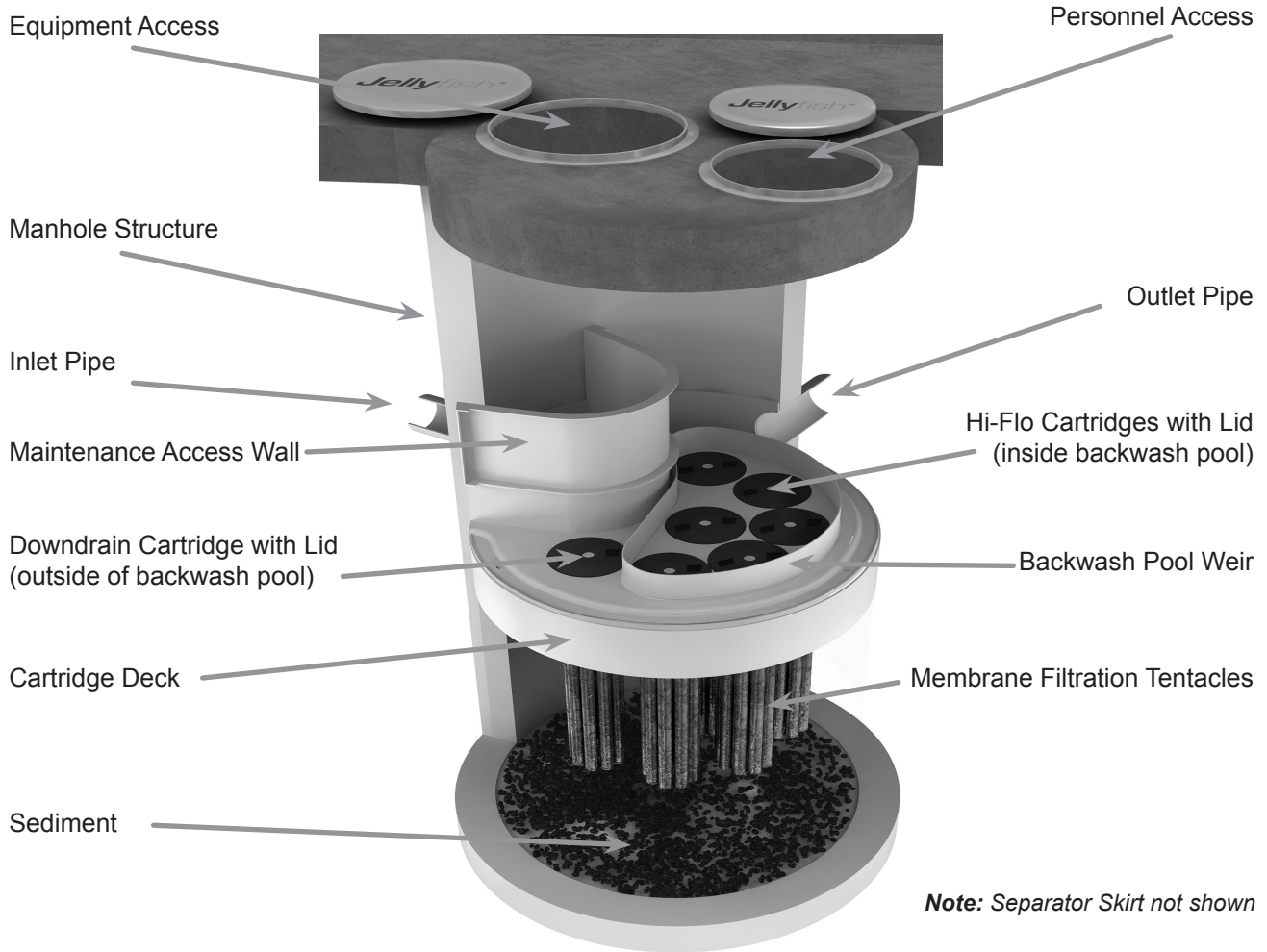

Tentacles are available in various lengths as depicted in Table 1 below.

**Table 1 – Cartridge Lengths / Weights and Cartridge Lid Orifice Diameters**

Cartridge Lengths	Dry Weight	Hi-Flo Orifice Diameter	Draindown Orifice Diameter
15 inches (381 mm)	10 lbs (4.5 kg)	35 mm	20 mm
27 inches (686 mm)	14.5 lbs (6.6 kg)	45 mm	25 mm
40 inches (1,016 mm)	19.5 lbs (8.9 kg)	55 mm	30 mm
54 inches (1,372 mm)	25 lbs (11.4 kg)	70 mm	35 mm

A Jellyfish membrane filtration cartridge is depicted in Figure 3 below.

**FIGURE 3**

**Jellyfish Membrane Filtration Cartridge**



**2.2 – Jellyfish Membrane Filtration Cartridge Assembly**

The Jellyfish Filter utilizes multiple membrane filtration cartridges. Each cartridge consists of removable cylindrical filtration “tentacles” attached to a cartridge head plate. Each filtration tentacle has a threaded pipe nipple and o-ring. To attach, insert the top pipe nipples with the o-ring through the head plate holes and secure with locking nuts. Locking nuts to be hand tighten and checked with a wrench as shown below.

**2.3 – Jellyfish Membrane Filtration Cartridge Installation**

- After the upstream catchment and site have stabilized, remove any accumulated sediment and debris from the Jellyfish Filter structure and upstream diversion structure (if applicable). Failure to address this step completely will reduce the time between required maintenance.
- Descend to the cartridge deck (see Safety Notice and page 3).
- Lower the Jellyfish membrane filtration cartridges into the cartridge receptacles within the cartridge deck. A filter cartridge should be placed into each of the draindown cartridge receptacles outside the backwash pool weir. It is possible dependent on the Jellyfish Filter model purchased that not all cartridge receptacles will be filled with a filter cartridge. In that case, a blank headplate and blank cartridge lid (has no orifice) would be installed.

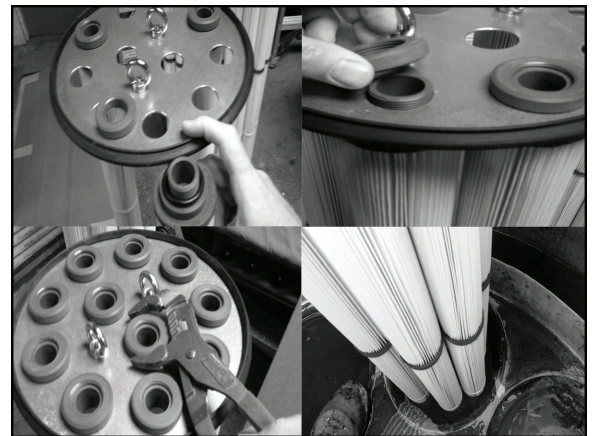

**Cartridge Assembly**

Avoid snagging the cartridge membranes on the receptacle lip when inserting the Jellyfish membrane filtration cartridges into the cartridge receptacles. Use a gentle twisting or sideways motion to clear any potential snag. Do not force the tentacles down into the cartridge receptacle, as this may damage the membranes. Apply downward pressure on the cartridge head plate to seat the rim gasket (thick circular gasket surrounding the circumference of the head plate) into the cartridge receptacle.

- Examine the cartridge lids to differentiate lids with a small orifice, a large orifice, and no orifice.
  - Lids with a small orifice are to be inserted into the draindown cartridge receptacles, outside of the backwash pool weir.
  - Lids with a large orifice are to be inserted into the hi-flo cartridge receptacles within the backwash pool weir.
  - Lids with no orifice (blank cartridge lids) and a blank headplate are to be inserted into unoccupied cartridge receptacles.
- **To install a cartridge lid, align the cartridge lid male threads with the cartridge receptacle female threads. Firmly twist the cartridge lid clockwise a minimum 110° to seat the filter cartridge snugly in place, with a proper watertight seal.**

## Chapter 3

### 3.0 – Inspection and Maintenance Overview

The primary purpose of the Jellyfish Filter is to capture and remove pollutants from stormwater runoff. As with any filtration system, captured pollutants must be removed to maintain the filter's maximum treatment performance. Regular inspection and maintenance are required to insure proper functioning of the system.

Maintenance frequencies and requirements are site specific and vary depending on pollutant loading. Maintenance activities may be required in the event of an upstream chemical spill or due to excessive sediment loading from site erosion or extreme runoff events. It is a good practice to inspect the system after major storm events.

Inspection activities are typically conducted from surface observations and include:

- Observe if standing water is present
- Observe if there is any physical damage to the deck or cartridge lids
- Observe the amount of debris in the Maintenance Access Wall (MAW)

Maintenance activities typically include:

- Removal of oil, floatable trash and debris
- Removal of collected sediments from manhole sump
- Rinsing and re-installing the filter cartridges
- Replace filter cartridge tentacles, as needed.

It is recommended that Jellyfish Filter inspection and maintenance be performed by professionally trained individuals, with experience in stormwater maintenance and disposal services. Maintenance procedures may require manned entry into the Jellyfish structure. Only professional maintenance service providers trained in confined space entry procedures should enter the vessel. Procedures, safety and damage prevention precautions, and other information, included in these guidelines, should be reviewed and observed prior to all inspection and maintenance activities.

### 3.1 – Inspection

#### 3.1.1 – Timing

Inspection of the Jellyfish Filter is key in determining the maintenance requirements for, and to develop a history of the site's pollutant loading characteristics. In general, inspections should be performed at the times indicated below; *or per the approved project stormwater quality documents (if applicable), whichever is more frequent.*

- Post-construction inspection is required prior to putting the Jellyfish Filter into service. All construction debris or construction-related sediment within the device must be removed, and any damage to system components repaired.
- A minimum of two inspections during the first year of operation to assess the sediment and floatable pollutant accumulation, and to ensure proper functioning of the system.

- Inspection frequency in subsequent years is based on the inspection and maintenance plan developed in the first year of operation. Minimum frequency should be once per year.
- Inspection is recommended after each major storm event.
- Immediately after an upstream oil, fuel or other chemical spill.

### 3.1.2 – Inspection Tools and Equipment

The following equipment and tools are typically required when performing a Jellyfish Filter inspection:

- Access cover lifting tool
- Sediment probe (clear hollow tube with check valve)
- Tape measure
- Flashlight
- Camera
- Inspection and maintenance log documentation
- Safety cones and caution tape
- Hard hat, safety shoes, safety glasses, and chemical-resistant gloves

### 3.1.3 – Inspection Procedure

The following procedure is recommended when performing inspections:

- Provide traffic control measures as necessary.
- Inspect the MAW for floatable pollutants such as trash, debris, and oil sheen.
- Measure oil and sediment depth by lowering a sediment probe through the MAW opening until contact is made with the floor of the structure. Retrieve the probe, record sediment depth, and presences of any oil layers and repeat in multiple locations within the MAW opening. **Sediment depth of 12 inches or greater indicates maintenance is required.**
- Inspect cartridge lids. Missing or damaged cartridge lids to be replaced.
- Inspect the MAW, cartridge deck, and backwash pool weir for cracks or broken components. If damaged, repair is required.
- **Dry weather inspections:** inspect the cartridge deck for standing water.
  - No standing water under normal operating condition.
  - Standing water **inside** the backwash pool, but not outside the backwash pool, this condition indicates that the filter cartridges need to be rinsed.
  - Standing water **outside** the backwash pool may indicate a backwater condition caused by high water elevation in the receiving water body, or possibly a blockage in downstream infrastructure.
- **Wet weather inspections:** observe the rate and movement of water in the unit. Note the depth of water above deck elevation within the MAW.
  - **Less than 6 inches**, flow should be exiting the cartridge lids of each of the draindown cartridges (i.e. cartridges located outside the backwash pool).
  - **Greater than 6 inches**, flow should be exiting the cartridge lids of each of the draindown cartridges and each of the hi-flo cartridges (i.e. cartridges located inside the backwash pool), and water should be overflowing the backwash pool weir.
  - **18 inches or greater** and relatively little flow is exiting the cartridge lids and outlet pipe, this condition indicates that the filter cartridges are occluded with sediment and need to be rinsed.



*The depth of sediment and oil can be measured from the surface by using a sediment probe or dipstick tube equipped with a ball check valve and inserted through the Jellyfish Filter's maintenance access wall opening. The large opening provides convenient access for inspection and vacuum removal of water and pollutants.*

## 3.2 – Maintenance

### 3.2.1 – Maintenance Requirements

Required maintenance for Jellyfish Filter units is based upon results of the most recent inspection, historical maintenance records, or the site specific water quality management plan; whichever is more frequent. In general, maintenance requires some combination of the following:

- **Sediment removal for depths reaching 12 inches or greater, or within 3 years of the most recent sediment cleaning, whichever occurs sooner.**
- Floatable trash, debris, and oil must be removed.
- Filter cartridges rinsed and re-installed as required by the most recent inspection results, or within 12 months of the most recent filter rinsing, whichever occurs first.
- Replace filter cartridge if rinsing does not remove accumulated sediment from the tentacles, or if tentacles are damaged or missing. It is recommended that tentacles should remain in service no longer than 5 years before replacement.
- Damaged or missing cartridge deck components must be repaired or replaced as indicated by results of the most recent inspection.
- The unit must be cleaned out and filter cartridges inspected immediately after an upstream oil, fuel, or chemical spill. Filter cartridge tentacles should be replaced if damaged by the spill.

### 3.2.2 – Maintenance Tools and Equipment

The following equipment and tools are typically required when performing Jellyfish Filter maintenance:

- Vacuum truck
- Ladder
- Garden hose and low pressure sprayer
- Rope or cord to lift filter cartridges from the cartridge deck to the surface
- Adjustable pliers for removing filter cartridge tentacles from cartridge head plate
- Plastic tub or garbage can for collecting effluent from rinsed filter cartridge tentacles
- Access cover lifting tool
- Sediment probe (clear hollow tube with check valve)
- Tape measure
- Flashlight
- Camera
- Inspection and maintenance log documentation
- Safety cones and caution tape
- Hard hats, safety shoes, safety glasses, chemical-resistant gloves, and hearing protection for service providers
- Proper safety equipment for confined space entry
- Replacement filter cartridge tentacles if required

### 3.2.3 – Maintenance Procedure

The following procedures are recommended when maintaining the Jellyfish Filter:

- Provide traffic control measures as necessary.
- Open all covers and hatches. Use ventilation equipment as required, according to confined space entry procedures.
- **Caution:** Dropping objects onto the cartridge deck may cause damage.
- Perform **Inspection Procedure** prior to maintenance activity.
- To access the cartridge deck for filter cartridge service, descend the ladder and step directly onto the deck. **Caution:** Do not step onto the maintenance access wall (MAW) or backwash pool weir, as damage may result. Note that the cartridge deck may be slippery.

### 3.2.4 – Filter Cartridge Rinsing Procedure

- Remove a cartridge lid.
- Remove the cartridge from the receptacle using the lifting loops in the cartridge head plate. **Caution:** Should

a snag occur, do not force the cartridge upward as damage to the tentacles may result. Rotate the cartridge with a slight sideways motion to clear the snag and continue removing the cartridge.

- Thread a rope or cord through the lifting loops and lift the filter cartridge from the cartridge deck to the top surface outside the structure.
- **Caution:** Immediately replace and secure the lid on the exposed empty receptacle as a safety precaution. Never expose more than one empty cartridge receptacle.
- Repeat the filter cartridge removal procedure until all of the cartridges are located at the top surface outside the structure.
- Disassemble the tentacles from each filter cartridge by rotating counter-clockwise. Remove the tentacles from the cartridge head plate.
- Position a receptacle in a plastic tub or garbage can such that the rinse water is captured. Using a low-pressure garden hose sprayer, direct a wide-angle water spray at a downward 45° angle onto the tentacle membrane, sweeping from top to bottom along the length of the tentacle. Rinse until all sediment is removed from the membrane. **Caution:** Do not use a high pressure sprayer or focused stream of water on the membrane. Excessive water pressure may damage the membrane. Turn membran upside down and pour out any residual rinsewater to ensure center of tentacle is clear of any sediment.
- Remove rinse water from rinse tub or garbage can using a vacuum hose as needed.
- Slip the o-ring over the tentacle nipple and reassemble onto the cartridge head plate; hand-tighten.
- If rinsing is ineffective in removing sediment from the tentacles, or if tentacles are damaged, provisions must be made to replace the spent or damaged tentacles with new tentacles. Contact Imbrium Systems to order replacement tentacles.
- Lower a rinsed filter cartridge to the cartridge deck. Remove the cartridge lid on a receptacle and carefully lower the filter cartridge into the receptacle until the head plate gasket is seated squarely on the lip of the receptacle. **Caution:** Should a snag occur when lowering the cartridge into the receptacle, do not force the cartridge downward; damage may occur. Rotate the cartridge with a slight sideways motion to clear the snag and complete the installation.
- Replace the cartridge lid on the exposed receptacle. Rinse away any accumulated grit from the receptacle threads if needed to get a proper fit. **Align the cartridge lid male threads with the cartridge receptacle female threads. Firmly twist the cartridge lid clockwise a minimum 110° to seat the filter cartridge snugly in place, with a proper watertight seal.**
- Repeat cartridge installation until all cartridges are installed.



*Rinsing of dirty filter cartridge tentacles with a low-pressure garden hose sprayer, and using a plastic garbage container to capture rinse water.*

### 3.2.5 – Vacuum Cleaning Procedure

- **Caution:** Perform vacuum cleaning of the Jellyfish Filter only after filter cartridges have been removed from the system. Access the lower chamber for vacuum cleaning **only through the maintenance access wall (MAW) opening**, being careful not to damage the flexible plastic separator skirt that is attached to the underside of the deck. The separator skirt surrounds the filter cartridge zone, and could be torn if contacted by the wand. **Do not lower the vacuum wand through a cartridge receptacle**, as damage to the receptacle will result.
  - To remove floatable trash, debris, and oil, lower the vacuum hose into the MAW opening and vacuum floatable pollutants off the surface of the water. Alternatively, floatable solids may be removed by a net or skimmer.
  - Using a vacuum hose, remove the water from the lower chamber to the sanitary sewer, if permitted by the local regulating authority, or into a separate containment tank.
  - Remove the sediment from the bottom of the unit through the MAW opening.
  - For larger diameter Jellyfish Filter manholes (8-ft, 10-ft, 12-ft diameter), complete sediment removal may be facilitated by removing a cartridge lid from an empty receptacle and inserting a jetting wand (not a vacuum wand) through the receptacle. Use the sprayer to rinse loosened sediment toward the vacuum hose in the MAW opening, being careful not to damage the receptacle..
  - After the unit is clean, re-fill the lower chamber with water if required by the local jurisdiction, and re-install filter cartridges.
  - Dispose of sediment, floatable trash and debris, oil, spent tentacles, and water according to local regulatory requirements.

### 3.2.6 – Chemical Spills

- **Caution:** If a chemical spill has been captured by the Jellyfish Filter, do not attempt maintenance. Immediately contact the local hazard response agency.

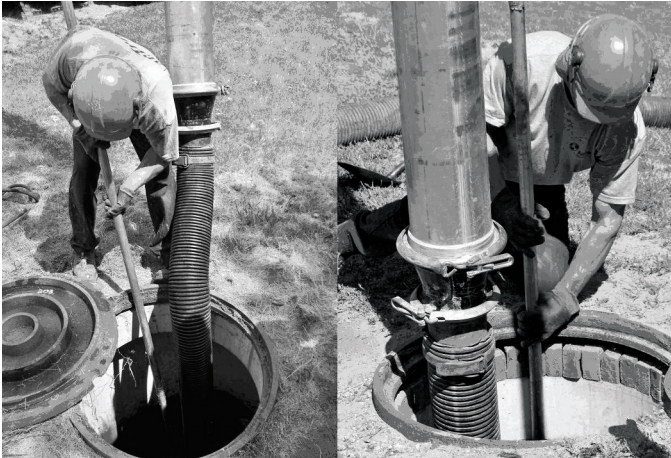

A maintenance worker stationed on the surface uses a vacuum hose to evacuate water, sediment, and floatables from the Jellyfish Filter by inserting the vacuum wand through the maintenance access wall opening.



A view of a Jellyfish Filter cartridge deck from the surface showing all the cartridge lids intact and no standing water on the deck (left image), and inspection of the flexible separator skirt from inside the maintenance access wall opening (right image).

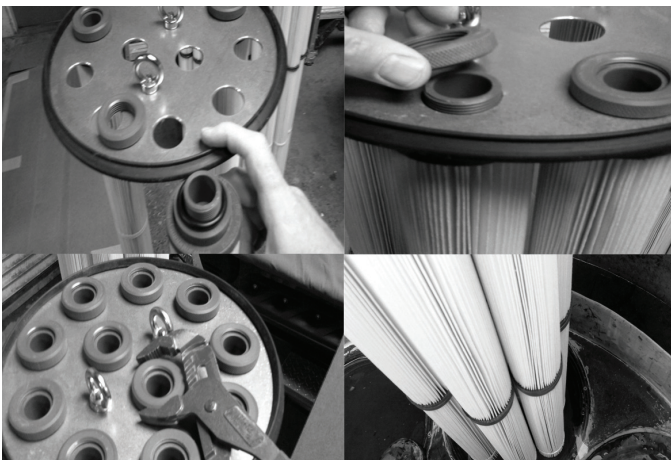

Assembly of a Jellyfish Filter cartridge (left) and installation of a filter cartridge into a cartridge receptacle in the deck (right).

### 3.3 – Disposal Procedures

Disposal requirements for recovered pollutants and spent filtration tentacles may vary depending on local guidelines. In most areas the sediment and spent filtration tentacles, once dewatered, can be disposed of in a sanitary landfill. It is not anticipated that the sediment would be classified as hazardous waste.

Petroleum-based pollutants captured by the Jellyfish Filter, such as oil and fuels, should be removed and disposed of by a licensed waste management company.

Although the Jellyfish Filter captures virtually all free oil, a sheen may still be present at the MAW. A rainbow or sheen can be visible at oil concentrations of less than 10 mg/L (ppm).

## Chapter 4

### 4.0 – Recommended Safety Procedures

Jobsite safety is a topic and a practice addressed comprehensively by others. The inclusions here are merely reminders to whole areas of Safety Practice that are the responsibility of the Owner(s), Manager(s) and Contractor(s). OSHA and Canadian OSH, and Federal, State/Provincial, and Local Jurisdiction Safety Standards apply.

### 4.1 – Confined Space/Personal Safety Equipment/Warning and Cautions

Please see reference on Page 3.

## Chapter 5

### 5.0 – Jellyfish Filter Replacement Parts

Jellyfish membrane filtration cartridges, cartridge components, cartridge lids, other replacement parts can be ordered by contacting Imbrium Systems at:

United States: 888-279-8826 or 301-279-8827  
Canada/International: 800-565-4801 or +1-416-960-9900  
[info@imbriumsystems.com](mailto:info@imbriumsystems.com)

### 5.1 – Jellyfish Filter Replacement Parts List

Note: Jellyfish Cartridges and/or Filtration tentacles are available in the following lengths:

- 15 Inch (381 mm)      • 27 Inch (686 mm)      • 40 Inch (1,016 mm)      • 54 Inch (1,372 mm)
- Jellyfish Cartridge (specify length). Includes head plate with lifting loops, rim gasket, eleven (11) filtration tentacles, eleven (11) o-rings, and eleven (11) locking nuts
- Standard Head plate
- Blank head plate
- Rim gasket (for head plate)
- Locking nuts (for tentacles)
- O-rings (for tentacles)
- Cartridge lids are available with the following orifice sizes: 70mm, 55mm, 45mm, 35mm, 30mm, 25mm, 30mm, blank lid (no orifice)
- Maintenance Access Wall (MAW) extension (18-inch segment)

*\* Nothing in this catalog should be construed as an expressed warranty or implied warranties, including the warranties of merchantability and of fitness for any particular purpose.*

# Jellyfish Filter Inspection and Maintenance Log

Owner: \_\_\_\_\_ Jellyfish Model No.: \_\_\_\_\_

Location: \_\_\_\_\_ GPS Coordinates: \_\_\_\_\_

Land Use:      Commercial: \_\_\_\_\_      Industrial: \_\_\_\_\_      Service Station: \_\_\_\_\_

Road/Highway: \_\_\_\_\_      Airport: \_\_\_\_\_      Residential: \_\_\_\_\_      Parking Lot: \_\_\_\_\_

Date/Time:						
Inspector:						
Maintenance Contractor:						
Visible Oil Present: (Y/N)						
Oil Quantity Removed						
Floatable Debris Present: (Y/N)						
Floatable Debris removed: (Y/N)						
Water Depth in Backwash Pool						
Draindown Cartridges externally rinsed and re-commissioned: (Y/N)						
New tentacles put on Cartridges: (Y/N)						
Hi-Flo cartridges externally rinsed and recommissioned (Y/N):						
New tentacles put on Hi-Flo Cartridges: (Y/N)						
Sediment Depth Measured: (Y/N)						
Sediment Depth (inches or mm):						
Sediment Removed: (Y/N)						
Cartridge Lids intact: (Y/N)						
Observed Damage:						
Comments:						