

## Engineering Report

# South March Battery Energy Storage System (BESS) Preliminary Geotechnical Investigation

H375142-0000-2A0-230-0001



2025-11-06	2	Approved for Use	T. Beadle	B. Kussmann	T. Beadle
2025-09-18	1	Approved for Use	T. Beadle	B. Kussmann	S. Chemanedji
2025-05-07	0	Approved for Use	T. Beadle	B. Kussmann	T. Beadle
<b>DATE</b>	<b>REV.</b>	<b>STATUS</b>	<b>PREPARED BY</b>	<b>CHECKED BY</b>	<b>APPROVED BY</b>
				<b>Discipline Lead</b>	<b>Functional Manager</b>

## IMPORTANT NOTICE TO READER

This report was prepared by Hatch Ltd. (“**Hatch**”) for the sole and exclusive use of Brookfield Renewable (the “**Principal**”) for the purpose of the South March Battery Energy Storage System (BESS) project. This report must not be used by the Principal for any other purpose, or provided to, relied upon or used by any other person without Hatch’s prior written consent.

This report contains the expression of the opinion of Hatch using its professional judgment and reasonable care based on information available and conditions existing at the time of preparation.

The use of, or reliance upon, this report is subject to the following:

1. This report is to be read in the context of and subject to the terms of the relevant Purchase Order (PO) No. C157954 between Hatch and the Principal (the “**Hatch Agreement**”), including any methodologies, procedures, techniques, assumptions and other relevant terms or conditions specified in the Hatch agreement;
2. This report is meant to be read as a whole, and sections of the report must not be read or relied upon out of context; and
3. Unless expressly stated otherwise in this report, Hatch has not verified the accuracy, completeness or validity of any information provided to Hatch by or on behalf of the Principal and Hatch does not accept any liability in connection with such information.

## Table of Contents

<b>1. Introduction</b>	<b>1</b>
<b>2. Project and Site Description</b>	<b>1</b>
<b>3. Geotechnical Standards</b>	<b>2</b>
<b>4. Investigation Procedures</b>	<b>2</b>
4.1 Health and Safety Plan	2
4.2 Utility Service Clearances	2
4.3 Borehole Drilling, Sampling and In-Situ and Field Testing	2
4.4 Field Electrical Resistivity Testing	3
4.5 As-Drilled Borehole Locations	4
<b>5. Laboratory Testing</b>	<b>5</b>
5.1 Geotechnical Laboratory Testing	5
<b>6. Geotechnical Results</b>	<b>6</b>
6.1 Regional Geology	6
6.2 Subsurface Conditions	6
6.2.1 Topsoil	7
6.2.2 Silty Sand	7
6.2.3 Silty Clay	7
6.2.4 Silty Clay (Glacial Till)	9
6.2.5 Granitic Gneiss Bedrock	10
6.2.6 Groundwater Conditions	10
6.3 Soil Chemical Testing	10
<b>7. Geotechnical Discussion and Design Considerations</b>	<b>11</b>
7.1 Site Preparation	11
7.1.1 Subgrade Preparation	11
7.1.2 Engineered Fill Requirements	13
7.1.3 Excavations	14
7.1.4 Potential for Expansive Soils	16
<b>8. Structures</b>	<b>16</b>
8.1 Shallow Foundations	16
8.2 Slab-On-Grade	19
8.3 Deep Foundations	20
8.3.1 Drilled Pier (Caisson) Foundations	20
8.3.2 Helical (Screw) Piles	21
8.3.3 Additional Design and Construction Recommendations	23
8.4 Lateral Earth Pressures	24
8.5 Transmission Line Poles	24

8.5.1	Axial and Lateral Capacity .....	25
8.6	Installation of Underground Services .....	26
8.6.1	Temporary Excavations .....	26
8.6.2	Pipe Bedding and Cover .....	27
8.6.3	Trench Backfill .....	27
8.7	Access Road Design .....	28
<b>9.</b>	<b>Corrosivity Analysis .....</b>	<b>30</b>
<b>10.</b>	<b>Seismic Classification for Seismic Response .....</b>	<b>30</b>

***List of Tables***

Table 4-1:	As-Drilled Borehole Identification and Depth .....	4
Table 6-1:	Summary of Interpreted Consolidation Parameters .....	9
Table 8-1:	Founding Elevations and Geotechnical Axial Resistances .....	17
Table 8-2:	Preliminary Geotechnical Axial Resistances for Caissons .....	21
Table 8-3:	Preliminary Factored Geotechnical Axial Resistances for Helical Piles .....	23
Table 8-4:	Lateral Earth Pressure Parameters .....	24
Table 8-5:	Access Road Construction Details .....	29

***List of Appendices***

<b>Appendix A</b>	<b>Record of Boreholes</b>
<b>Appendix B</b>	<b>Geotechnical Laboratory Testing</b>
<b>Appendix C</b>	<b>Advanced Geotechnical Laboratory Testing</b>
<b>Appendix D</b>	<b>Chemical Testing</b>
<b>Appendix E</b>	<b>Electrical Resistivity Testing</b>
<b>Appendix F</b>	<b>Rock Core Photographs</b>
<b>Appendix G</b>	<b>Conceptual Foundation Drawings</b>
<b>Appendix H</b>	<b>Geophysics Report</b>

## 1. Introduction

Hatch Ltd. (Hatch) has been retained by Brookfield BRP Canada Corporation (Brookfield) to provide geotechnical investigation services as part of the South March Battery Energy Storage System (BESS) project (Project) under Purchase Order (PO) No. C157954.

The investigation was conducted in accordance with Project Addendum No. P-079708. Proposed geotechnical investigation documents were prepared for the South March BESS where geotechnical investigations were required and submitted to Brookfield for review and approval prior to initiation based on our understanding of the project scope. The investigations were carried out at locations selected by Hatch and approved by Brookfield at the project site.

The objective of the investigation was to characterize the soil, rock and groundwater conditions (where applicable) at the BESS site by advancing boreholes at select locations. This geotechnical investigation report presents the investigation methodology, records of boreholes and coreholes, geotechnical field and laboratory test data completed to date and geotechnical analyses and recommendations for foundation design of the South March BESS facility and ancillary structures, as well as general construction considerations. In addition, this report identifies and discusses potential geological and geotechnical hazards and their associated risks.

This report should be read in conjunction with the “Important Notice to Reader”. The reader’s attention is specifically drawn to this information, as it is essential for the proper use and interpretation of this report. If information or assumptions contained herein are incorrect, please inform Hatch so that we may amend our recommendations as appropriate.

## 2. Project and Site Description

The South March BESS project is directly responding to the Independent Electricity System Operator’s (IESO) request to increase supply and capacity to meet Ontario’s growing electricity expenditure and demand by constructing an energy storage facility. The facility will increase renewable grid capacity and storage, enhance flexible grid operations and provide a low carbon initiative to avoid greenhouse gas emissions by reducing reliance on higher carbon intensive facilities.

Based on the drawing entitled “Civil, General Arrangement, Plan, Sungrow” dated October 22, 2024, Drawing No. 7154023-100000-41-D20-00002, Brookfield is proposing to develop approximately 15 acres of 150 acres of property at 2555 and 2625 Marchurst Road in Dunrobin, Ontario, approximately 26 km southwest of Ottawa. Hatch understands the Project will consist of about 432 battery energy storage “cabinets” in about 108 “modules”, a substation, transmission line, access roads and associated electrical infrastructure.

A key plan outlining the site location is shown on Figure 1 following the text of this report.

### **3. Geotechnical Standards**

The geotechnical investigation, soil/rock descriptions and the graphical representations of the soil types are in general accordance with the American Society for Testing and Materials (ASTM) D2488-17. Geotechnical field, in-situ and laboratory testing was carried out in accordance with the relevant testing methods specified in the American Society for Testing and Materials (ASTM) Standards.

### **4. Investigation Procedures**

#### **4.1 Health and Safety Plan**

Prior to initiating the field work at the site, Hatch prepared a site-specific Health and Safety Environment Plan (HSEP) for Hatch staff and subcontractor use. The HSEP addressed health and safety within the work area and established contingency plans for emergencies that may occur during the field work.

#### **4.2 Utility Service Clearances**

Underground public utility clearances were obtained through Ontario One Call prior to initiating the intrusive investigation. A private utility locator was also retained to confirm that the proposed borehole locations were clear of private underground utilities for boreholes located within private property.

#### **4.3 Borehole Drilling, Sampling and In-Situ and Field Testing**

The proposed borehole locations were selected by Hatch's geotechnical staff and approved by Brookfield prior to mobilization. Hatch located the boreholes in the field using measurements relative to existing site features and a hand-held Global Positioning System (GPS) device. Detailed below, the geotechnical investigation program consisted of the following:

- Standard Penetration Test (SPT) split-spoon sampling was carried out at ten (10) borehole locations for the proposed BESS site (Boreholes FY24-1 to FY24-9 and FY25-4);
- Standard Penetration Test (SPT) split-spoon sampling was carried out at three (3) borehole locations for the proposed transmission line poles (Boreholes FY25-1 to FY25-3);
- Rock coring was completed in two select boreholes (Boreholes FY24-1 and FY25-1);
- One monitoring well was installed in Borehole FY24-1; and
- Electrical Resistivity Testing was completed along two lines.

OGS Inc. (OGS) of Almonte, Ontario, supplied and operated a track-mounted drill rig to advance the SPT boreholes/coreholes as detailed above and as shown on the Borehole Location Plan in Figure 1 following the text of this report.

The field work was observed by members of Hatch's engineering and technical staff, who located the boreholes, arranged for the clearance of underground services, observed the drilling investigation and soil sampling, photographed and recorded field observations, in-situ testing operations, logged the boreholes, and examined the soil samples.

The SPT boreholes were advanced by hollow stem augers and soil samples were taken at 0.76-m intervals within the upper approximately 4.6 m, and at 1.5-m intervals below the 4.6 m depth using 50-mm diameter split-spoon samplers, in accordance with the SPT procedure (ASTM D1586-08a: Standard Test Method for Standard Penetration Tests and Split Barrel Sampling of the Soil). Pocket penetrometer tests were carried out on the cohesive soil SPT samples once retrieved from the borehole. Thin-walled Shelby tube samples were retrieved in select soil strata, where possible, in accordance with ASTM Standard D1587, in order to complete advanced geotechnical laboratory testing on the collected samples. In-situ vane shear testing (ASTM D2573) was completed in the cohesive soils, where possible, with a 'N' sized vane.

The soil samples were described and logged in the field with respect to soil type/group and moisture content. Bedrock coring completed in two boreholes was carried out using a HQ sized core barrel.

Bulk soil samples were collected in sealed 5-gallon buckets from auger cuttings at depths of approximately 0.3 m to 1.5 m below ground surface for thermal resistivity, standard Proctor and California Bearing Ratio (CBR) laboratory tests. Bulk samples on which moisture content and classification testing were performed were placed in sealed bags.

For geotechnical investigation purposes, the soil SPT, Shelby tube samples and rock cores were labelled and transported to Hatch's Niagara Falls geotechnical laboratory where the samples underwent further visual examination and laboratory testing. Bulk samples were shipped to Soil Engineering Testing, Inc., (SET) in Bloomington, Minnesota for the specified testing.

#### **4.4 Field Electrical Resistivity Testing**

Field electrical resistivity testing was completed at a total of two locations. The resistivity testing was completed in accordance with ASTM method G57 "Standard Test Method for Field Measurement of Soil Resistivity Using the Wenner Four-Electrode Method" (equivalent to IEEE Std. 81). Electrode "A" spacings of 2, 5, 10, 20, 50, 100, and 200 ft were used at the test locations. At each of the locations, measurements were taken to determine average soil resistivity along the test sections.

The equipment used to collect the data consisted of a resistivity meter, four metal electrodes and connecting wire. Co-linear arrays of four electrodes were placed in the ground for each measurement. Electrical current was input to the ground through the two outer electrodes of the array. The voltage drop produced by the resulting electrical field was measured across the two inner electrodes. The “A” spacing was increased with each measurement, expanding the array about a common center. Increasing the electrode separation increases the depth of exploration and indicates vertical variation in resistivity. The resistivity meter reported apparent resistivity; the conversion of electrical potential and inductance to apparent resistivity was not required.

## 4.5 As-Drilled Borehole Locations

The as-drilled borehole locations were surveyed using a hand-held GPS unit and the ground surface elevations were interpolated from site survey provided by Brookfield referenced to a High-Resolution Digital Elevation Model (HRDEM), dated February 2025. Borehole locations are shown on the Borehole Location Plan and referenced to NAD 83 MTM Zone 9. Elevations noted on the Record of Borehole sheets in Appendix A are referenced to Canadian Geodetic Vertical Datum 2013 (CGVD2013). A summary of the borehole locations and elevations are summarized in Table 4-1 below.

**Table 4-1: As-Drilled Borehole Identification and Depth**

Borehole Location	Borehole Type	Northing (m)	Easting (m)	Ground Surface Elevation (m)	Borehole Depth (m)	Monitoring Well Depth / Screened Interval (m)
FY24-1	SPT / NQ Rock Core	5,028,520.19	340,593.57	100.89	9.14	9.14 / 1.22 - 4.27
FY24-2	SPT	5,028,632.28	340,428.35	100.19	1.20	-
FY24-3	SPT	5,028,685.75	340,470.80	99.04	2.85	-
FY24-4	SPT	5,028,617.03	340,502.04	100.10	1.05	-
FY24-5	SPT	5,028,675.83	340,603.10	99.22	7.55	-
FY24-6	SPT	5,028,607.61	340,644.90	100.43	3.55	-
FY24-7	SPT	5,028,576.59	340,719.30	103.20	4.65	-
FY24-8	SPT	5,028,511.78	340,657.27	102.89	0.75	-
FY24-9	SPT	5,028,663.08	340,667.29	100.20	3.60	-
FY25-1	SPT	5,028,338.15	340,483.99	101.35	10.55	-
FY25-2	SPT	5,028,353.32	340,488.79	101.26	2.55	-
FY25-3	SPT	5,028,398.85	340,502.84	101.11	5.20	-
FY25-4	SPT	5,028,549.33	340,433.41	100.78	0.45	-

The as-drilled borehole locations may differ slightly from the proposed borehole locations due to site access considerations.

## 5. Laboratory Testing

### 5.1 Geotechnical Laboratory Testing

The following geotechnical testing was carried out on selected soil samples:

- Moisture Content (ASTM D2216);
- Grain Size Distribution (ASTM D6913);
- Atterberg Limits (ASTM D4318);
- Unconsolidated Undrained Triaxial Compression Tests for Cohesive Soil (ASTM D2850);
- Unconfined Compressive Strength Tests of Cohesive Soils (ASTM D2166);
- One-Dimensional Soil Consolidation Test (ASTM D2435);
- One-Dimensional Swell or Collapse of Soils (ASTM D4546-21);
- Thermal Resistivity Test (ASTM D5334);
- California Bearing Ratio (ASTM D1883);
- Standard Proctor Density (ASTM D698);
- Soil pH tests (ASTM G51); and
- Soluble chloride and soluble sulfate of soils (ASTM D4327).

The geotechnical test results carried out on selected soil samples are shown on the Record of Borehole sheets presented in Appendix A. The results of the classification tests are presented in Appendix B. The advanced geotechnical laboratory testing results are presented in Appendix C.

A soil sample for thermal resistivity testing was collected at the location of Borehole FY24-1. The sample was transported to Soil Engineering Testing, Inc., (SET) in Bloomington, Minnesota for laboratory testing in accordance with ASTM D5334, "Standard Test Method for Determination of Thermal Conductivity of Soil and Soft Rock by Thermal Needle Probe Procedure". Bulk samples were recompacted to 85% of the soils Maximum Dry Density (MDD). California Bearing Ratio (CBR), standard Proctor and grain size distribution testing were also conducted on the bulk sample recompacted to 95% MDD. The test reports are presented in Appendix C.

## 6. Geotechnical Results

### 6.1 Regional Geology

As delineated in *The Physiography of Southern Ontario*<sup>1</sup>, the South March BESS site lies within the physiographic region known as the Ottawa Valley Clay Plain. This region is characterized by relatively thick deposits of sensitive marine clay, silty clay and silt that were deposited within the Champlain Sea basin. These deposits, known as the Champlain Sea clay or Leda clay, overlie relatively thin, reworked glacial till and glaciofluvial deposits which overlie bedrock.

West of the Carp River valley, the upper bedrock consists of limestone of the Ottawa Formation. Within and immediately east of the Carp River valley, the upper bedrock consists of sandstones and dolostones that have been cut by igneous and metamorphic rocks controlled by faulting in the vicinity of the Carp River.<sup>2</sup>

### 6.2 Subsurface Conditions

The detailed subsurface soil and rock conditions encountered in the boreholes advanced as part of the investigation and the results of the in-situ, field and laboratory testing are provided in the following appendices:

- Appendix A - Record of Boreholes.
- Appendix B - Soil Classification Testing (Grain-Size Distribution).
- Appendix C - Advanced Laboratory Testing.
- Appendix D - Chemical Testing.
- Appendix E - Electrical Resistivity Testing.
- Appendix F - Rock Core Photographs.
- Appendix G - Conceptual Foundation Drawings.
- Appendix H - Geophysics Report.

---

<sup>1</sup> Chapman, L. J. and Putnam, D. F. 1984. *The Physiography of Southern Ontario*, Ontario Geological Survey. Special Volume 2, Third Edition. Accompanied by Map P.2715, Scale 1:600,000. Ontario Ministry of Natural Resources.

<sup>2</sup> Belanger, J. R. "Urban Geology of Canada's National Capital Area", in *Urban Geology of Canadian Cities*, Geological Association of Canada Special Paper 42, Ed. P.F. Karrow and O.L. White, 1998.

Classification and identification of the soils are based on the American Society of Testing and Materials (ASTM) D2488-17 - Standard Practice for Description and Identification of Soils. The stratigraphic boundaries shown on the Record of Borehole sheets are inferred from non-continuous sampling, observations of drilling progress and results of SPTs. These boundaries, therefore, represent transitions between soil types/groups rather than exact planes of geological change. Further, subsurface conditions will vary between and beyond the borehole locations.

A detailed description of the subsurface conditions encountered in the boreholes is provided in the following sections.

### **6.2.1 Topsoil**

Topsoil was encountered in all boreholes advanced at the site and is 100 mm to 600 mm thick. Materials identified as topsoil in this report were classified based on visual and textural evidence and no other testing for organic content or other nutrients was carried out. Localized zones of thicker or thinner surficial soil with variable organic content should be expected across the site depending on the agricultural use and topography.

### **6.2.2 Silty Sand**

Silty sand was encountered below the topsoil in Boreholes FY24-4 and FY24-7 at depths of 0.1 m and 0.3 m below ground surface and is 0.5 m and 0.6 m thick, respectively. Silty sand was also encountered below the silty clay deposit in Borehole FY24-1, discussed below, at a depth of 4.9 m below ground surface and is 1.1 m thick.

The measured SPT 'N' values within the silty sand ranges from 2 blows to 13 blows per 0.3 m of penetration, indicating a very loose to compact state of relative compaction.

### **6.2.3 Silty Clay**

Silty clay was encountered below the topsoil in all boreholes advanced at the site, except Boreholes FY24-4 and FY24-7 where the silty clay was encountered below the silty sand. The silty clay was measured to be 0.2 m to 5.2 m thick in the boreholes. The silty clay contains trace sand.

The measured SPT 'N' values within the silty clay range from 2 blows to 29 blows per 0.3 m of penetration, suggesting a very soft to very stiff consistency. The measured SPT 'N' values measured in the upper about 2 m to 3 m of the silty clay generally correlated to a firm to stiff consistency with the consistency becoming softer with depth (very soft to soft).

Field vane tests conducted within Boreholes FY24-1 and FY24-5 indicated peak undrained shear strengths ranging from about 20 kPa to greater than 96 kPa (field vane would not turn) and remoulded values ranging from 6 kPa to 15 kPa. The field vane tests indicate that the silty clay has a soft to stiff consistency with a sensitivity of about 2 to 15, where tested. Where the silty clay was tested, the soils are considered to have low to high sensitivity<sup>3</sup>.

The results of grain-size distribution testing conducted on three samples of the silty clay are shown in Appendix B.

Atterberg limits testing conducted on twelve samples of the silty clay measured liquid limits ranging from 33% to 51%, plastic limits ranging from 14% to 23% and plasticity indices ranging from 19% to 29%. The results of the Atterberg limits testing are shown plasticity charts in Appendix B and indicate that the tested samples are silty clay of low to high plasticity (CL to CH).

The water content measured on samples of the silty clay range from 10% to 55%.

Unconsolidated Undrained (UU) triaxial compression testing was conducted on two samples of the silty clay. The UU testing indicated undrained shear strengths of 106 kPa in Borehole FY24-1 and 68 kPa in Borehole FY24-5.

An Unconfined Compressive Strength (UCS) test was conducted on one sample of the silty clay and the results indicated a compressive strength of 182 kPa which correlates to an undrained shear strength of 91 kPa (1/2 compressive strength).

One-dimensional swell potential testing was completed on two samples of the silty clay obtained from Boreholes FY24-01 and FY24-05. The tested samples did not show evidence of swelling during the testing. The results of the one-dimensional swell tests are provided in Appendix C.

A laboratory compaction test was conducted on the bulk soil sample and the Standard Proctor testing indicated the maximum dry density was 16.3 kN/m<sup>3</sup> with a corresponding optimum moisture of 21.6%. The results of the standard Proctor tests are provided in Appendix C.

The bulk soil sample was also compacted to 95% of the maximum standard Proctor density at the optimum moisture content and subsequently soaked for 96 hours before California Bearing Ration (CBR) tests were performed. The test results indicated a CBR value of 3.1%. The results of the testing are provided in Appendix C.

---

<sup>3</sup> Robert D. Holtz and William D. Kovacs, An Introduction to Geotechnical Engineering, 1981.

Thermal resistivity testing was conducted on the bulk soil sample of the silty clay collected from about 0.3 m to 1.5 m below ground surface at Borehole FY24-1. The bulk sample was recompacted to 85% of the soil's maximum dry density (MDD) and thermal dry-out curve populated based on the moisture content vs. the thermal resistivity measured with the needle probe. The results of the thermal resistivity testing are provided in Appendix C.

### 6.2.3.1 Consolidation Testing

One-dimensional consolidation (oedometer) testing was conducted on one sample of the silty clay collected at a depth of about 4.9 m below ground surface in Borehole FY24-05. The data from the oedometer test was used to interpret consolidation parameters such as compression index ( $c_c$ ), recompression index ( $c_r$ ) and Overconsolidation Ratio (OCR) and are summarized in Table 6-1 below. The test results are provided in Appendix C.

**Table 6-1: Summary of Interpreted Consolidation Parameters**

Borehole and Sample No.	Average Depth of Sample (m)	Soil Type	$W_n$ (%)	$\sigma_{vo}'$	$\sigma'_p$	$e_o$	$C_c$	$C_r$	OCR
FY24-5 TO1	4.9	Silty Clay	52	60	175	1.44	0.55	0.055	2.9

Where:

$w_n$  - Initial water content prior to testing

$e_o$  - Initial void ratio

$\sigma_{vo}'$  - Computed existing vertical effective stress

$\sigma'_p$  - Preconsolidation pressure

$c_c$  - Compression index

$c_r$  - Recompression index

OCR - Overconsolidation ratio

### 6.2.4 Silty Clay (Glacial Till)

A deposit of silty clay till was encountered below the silty clay in Borehole FY24-6 at a depth of 3.0 m below ground surface. Borehole FY24-6 was terminated within the silty clay till at a depth of about 3.6 m below ground surface after encountering split-spoon refusal on inferred bedrock surface.

A measured SPT 'N' value within the silty clay till was 28 blows to per 0.3 m of penetration, suggesting a very stiff consistency.

The water content measured on a sample of the silty clay till was 25%.

### **6.2.5 Granitic Gneiss Bedrock**

Granitic Gneiss bedrock was encountered below the overburden materials in all boreholes advanced at the site. The bedrock was inferred by split-spoon and auger refusal in Boreholes FY24-2 to FY24-8, FY25-2 to FY25-4 and confirmed by coring the rock in Boreholes FY24-1 and FY25-1. The bedrock was cored from 6.1 m to 9.1 m below ground surface in Borehole FY24-1 and from 5.7 m to 10.6 m in Borehole FY25-1. The bedrock core samples were described as fresh, very strong, fine to medium grained, very thinly bedded and grey, black, light pink and white in colour. Further details of the granitic gneiss bedrock are shown on the Record of Borehole/Corehole sheets in Appendix A. **Error! Reference source not found.** Photographs of the recovered bedrock cores are shown in Appendix E.

### **6.2.6 Groundwater Conditions**

The groundwater level within the boreholes was monitored during advancement and in the open boreholes upon completion. A monitoring well was installed in Borehole FY24-1 for long term groundwater monitoring. Details of the monitoring well installation are shown on the Record of Borehole sheets in Appendix A.

The water level measured in the open boreholes upon completion of drilling ranged from about 1.0 m to 1.3 m below ground surface. The groundwater level measured in the monitoring well installed in Borehole FY24-1 ranged from about 1.8 m to 2.6 m below ground surface during the monitoring events. Further details of the groundwater level monitoring can be found on the Borehole Records in Appendix A.

The groundwater level at the site is expected to fluctuate seasonally in response to change in the precipitation and snowmelt and is expected to be higher during the spring and during periods of precipitation.

## **6.3 Soil Chemical Testing**

Chemical tests, consisting of soil pH, soluble chlorides and soluble sulfates, were performed on two samples collected at the Project site. The results of the chemical testing indicate that soil had a pH ranging from 7.10 to 7.16, resistivity ranging from 106 to 175 Ohm\*m, and a soluble sulfate concentration ranging from 6 to 10 µg/g. The chemical test results are shown in Appendix D.

Chemical testing was also conducted on samples from Borehole FY25-1 according to Hydro One's "Technical Specification for Geotechnical Investigation" which was provided to Hatch from Brookfield. The testing was conducted on a bulk sample from 0.5 m, 1.5 m and 3.0 m below ground surface from Borehole FY25-1 for testing according to Ontario Regulation (O.Reg.) 153. Testing was also conducted on a soil sample taken from about 1.5 m below ground surface according to O.Reg. 558. The test results are provided in Appendix D.

## 7. Geotechnical Discussion and Design Considerations

This section of the report presents an interpretation of the factual geotechnical data to date and provides geotechnical design recommendations for the proposed BESS and associated structures. These discussions and recommendations are based on our understanding of the project and our interpretation of the factual data obtained from the December 2024 and July 2025 geotechnical investigations as well as the geophysics investigation completed in April 2025.

This section of the report provides engineering information for the geotechnical design aspects of the project, based on our interpretation of the borehole data and on our understanding of the project requirements. The information in this portion of the report is provided for the guidance of the design engineers and professionals. Where comments are made on construction considerations, they are provided only to highlight aspects of construction which could affect the design of the project. Contractors bidding on or undertaking any work at the site should examine the factual results of the investigation, satisfy themselves as to the adequacy of the information for construction and make their own interpretation of the factual data as it affects their proposed construction techniques, schedule, equipment capabilities, costs, sequencing, and the like. If the project is modified in concept, location or elevation, Hatch should be given the opportunity to confirm that the recommendations in this report are still valid.

This report addresses only the geotechnical (physical) aspects of the subsurface conditions at this Site. The geo-environmental (chemical) aspects, including the consequences of possible surface and/or subsurface contamination resulting from previous activities or uses of the Site and/or resulting from the introduction onto the site of materials from off-site sources, are outside of the terms of reference for this report.

Based on the results of this investigation, the subsurface soil conditions encountered at the Site are considered to generally be suitable for the proposed development, which is understood to comprise of BESS structures, a substation structure, transmission line, access roads and associated electrical servicing based on the drawing entitled "Civil, General Arrangement, Plan, Sungrow" dated October 22, 2024, Drawing No. 7154023-100000-41-D20-00002.

### 7.1 Site Preparation

#### 7.1.1 *Subgrade Preparation*

It is understood from drawings provided to Hatch that the BESS development will consist of a BESS area, a substation area with site servicing and access roads. To achieve the proposed design grades, it is assumed that minor cut and/or fill site grading operations (i.e., less than 0.5 m) will be required to establish subgrade levels and permit construction of the proposed development.

As discussed in Section 6.2, the subsurface conditions at the site generally consist of topsoil underlain by clayey soils of the Champlain Sea Basin deposit which varies in moisture content, consistency and plasticity across the site and with depth. The clay soils are underlain by granitic gneiss bedrock which varies in elevation across the site. Based on the conditions encountered during the geotechnical investigation, in-situ testing and the results of the laboratory testing, the clayey soils are considered to be compressible in nature and prone to settlement when overstressed by external loads that are close to or exceeding the pre-consolidation pressure or yield stress of the soil. Such external loads include grade raises, equipment and structure foundations, pavement structure (if filling required) and the lowering of the groundwater table (if required).

In the areas of the site underlain by the clayey soils, as encountered across the site, large grade raises should be avoided to minimize settlement and should be kept to a maximum of 0.5 m. As noted, site grading details for the site were not known at the time of this report and, as such, when these details have been determined, if significant grade raises are required for the site, a detailed settlement analysis should be conducted to determine the long-term effects of the grade raises across the site and at settlement sensitive structure foundations such as the BESS “cabinets” and substation structures. If significant grade changes are required in areas with silty clay soils, pre-consolidation measures (such as preloading) may be needed in advance of earthwork activities.

Any filling carried out at the Site in conjunction with grading (with the exception of future green spaces) should be carried out as engineered fill. Recommendations for the placement of engineered fill are outlined in Section 7.1.2 of this report. In general, the existing vegetation, surficial topsoil, reworked soil, the clayey soils or other near-surface soils containing significant amounts of organic matter are not considered to be suitable for the subgrade support of engineered fill, foundations, slabs or other settlement sensitive structures. These materials should be completely stripped prior to placing any engineered fill or construction of foundations or exterior slab-on-grade(s).

The near surface subgrade soils consist of silty clay materials which are subject to disturbance when exposed. Therefore, the site grading should ideally be scheduled during the summer months and construction methods should be adopted to avoid running heavy equipment (other than where proof-rolling is being conducted) directly on the exposed clayey subgrade soils to avoid disturbing the subgrade.

Following the stripping of the surficial topsoil, reworked soil, clayey soils, and/or soils containing significant amounts of organics and/or soft/disturbed areas, the exposed subgrade should be heavily proof-rolled with suitable equipment, such as a heavy roller or partially loaded truck, in conjunction with inspection by qualified geotechnical personnel to confirm that the exposed soils are competent and have been adequately stripped of ponded water and all disturbed, loosened, softened, organic and other deleterious material. Remedial work (i.e., further sub-excavation and replacement) should be carried out on poorly performing areas identified during the proof-rolling activities, as directed by a geotechnical professional. Poorly performing or disturbed areas should be excavated and removed to expose undisturbed competent soil or rock and backfilled to the design grade with Granular 'B'. If the depth of excavation becomes excessive and the very soft to firm clay is exposed, ground stabilizing measures may be required such as placing a Geogrid Reinforcement or use of chemical stabilization (i.e. lime, cement, and/or fly ash).

### **7.1.2 Engineered Fill Requirements**

As described above, the anticipated site grading activities are expected to include both cutting and raising (filling) the original grade to meet the final design site grades. The native silty clay soils encountered in the boreholes advanced at the site are not considered suitable as engineered fill in settlement sensitive areas such as beneath proposed foundations, access roads or utilities. However, this material could be used for general grade raises in landscape areas around the proposed development.

Imported engineered fill will be required for any grade raises at the site in settlement sensitive areas. If imported material is required for the engineered fill process, the material that is proposed for use as engineered fill should be approved by the geotechnical engineer, at its source, prior to importing the material to the site. In this regard, imported materials which meet the requirements for OPSS Select Subgrade Material (SSM) would be suitable for use as engineered fill. Suitable soils, free of topsoil, organic matter, cobbles/boulders or other deleterious materials can be used as engineered fill provided that the water content of the soil at the time of placement does not vary by more than 2% above or below its optimum water content for compaction. Otherwise, the soils may require treatment (i.e., drying or wetting) prior to placement. All oversized cobbles (i.e., greater than 150 mm in size) and boulders, if present, should be removed from the material to be used as engineered fill material.

It should be noted that the native subsurface material at the site is susceptible to over-wetting and subsequent freezing during inclement weather. Therefore, it is recommended that site grading activities not be carried out during late fall, winter, early spring seasons or any periods of inclement weather conditions.

Following the inspection and approval of the subgrade as described previously in this report, engineered fill materials should be placed in maximum 300 mm thick loose lifts and uniformly compacted to 98% of the Standard Proctor Maximum Dry Density (SPMDD). Filling should continue until the design elevations are achieved. Full-time monitoring and in-situ density testing should be carried out during placement of engineered fill.

The final surface of the engineered fill should be protected, as necessary, from construction traffic and should be sloped to provide positive drainage for surface water during the construction period. If the engineered fill materials will be left exposed (i.e., uncovered) during periods of freezing weather, additional soil cover should be placed above final subgrade to provide some level of frost protection. Areas excavated and replaced with non-frost susceptible Granular 'B' fill should be topped with a minimum of 150 mm of Granular 'A' fill to reduce infiltration.

Where the BESS foundations will be founded on the bedrock surface (on bedrock outcrops or where the silty clay has been excavated to bedrock surface), filling/levelling will be required to prepare a level surface to place the foundation. The filling should consist of Granular 'B' placed, as noted above, on the cleaned bedrock surface and grade raised to 150 mm below the final grade level. The final lift above the Granular 'B' should consist of a minimum of 150 mm Granular 'A' pad. Alternatively, where material is excavated over bedrock, filling/levelling could be achieved by pouring lean concrete on the bedrock up to the required design grades.

### 7.1.3 **Excavations**

For the purpose of this report, the maximum depth of the foundation footings and underground services was assumed to be up to about 2 m below the existing ground surface (below frost penetration depth). The founding soils at this depth are anticipated to generally consist of the native silty clay or bedrock. The upper portion of the silty clay material (encountered to about 2 m to 3 m below ground surface) is considered to be suitable for supporting the BESS structures on shallow foundations consisting of strip or spread footings provided that the integrity of the base of the excavations is maintained during construction.

Slab-on-grade foundations placed on the native silty clay materials could be considered; however, the compressibility of subgrade soils could cause intolerable settlements of the slab-on-grade foundations. Therefore, design loads and settlement tolerances from the structural designer should be provided to the geotechnical engineer of record and a detailed settlement analysis carried out to determine if the calculated settlements are tolerable. The slab-on-grade foundations are considered to be suitable in areas where founded directly on the bedrock or on engineered fill placed above the bedrock following excavation of the native subsurface soils.

It is noted that the bedrock elevation varied considerably across the site from ground surface (exposed at surface) to greater than 7.5 m below ground surface. Therefore, foundation conditions and preparation will vary from structure to structure depending on the area of construction on the site.

Where softened or disturbed native soils or other deleterious materials are encountered at the base of excavations for settlement-sensitive foundations or underground services, these materials should be sub-excavated and replaced with compacted fills approved by the geotechnical engineer.

Care should be taken to direct surface water away from any open excavations and all temporary excavations should be carried out in accordance with the Occupational Health and Safety Act (OHSA) and Regulations for Construction Projects. In general, the groundwater levels measured in the open boreholes upon completion of drilling ranged from about 1.0 m to 1.3 m below ground surface during the geotechnical investigation. The groundwater level measured in the monitoring well installed in Borehole FY24-1 ranged from 1.8 m to 2.6 m below ground surface. The groundwater in the excavations within the native silty clay deposits are likely to be handled by collection via properly constructed and filtered sumps, located within the excavations, and then pumping and discharging the water to a suitable discharge point.

All temporary excavations must be carried out in accordance with the requirements of the OHSA. The soil types, as defined in the OHSA, for overburden soils present at the proposed BESS development site are summarized below as an aid for design:

- Very soft to stiff silty clay - Type 4 soil.

For open excavations, Type 4 soils must be sloped from the bottom of the excavation with an allowable slope of 3H:1V. Depending upon the construction procedures adopted, the groundwater seepage conditions and weather conditions at the time of construction, some local flattening of the slopes of open cut excavations may be required, especially in looser/softer zones or where localized seepage is encountered. Further, layering of soils could affect the OHSA classification and, therefore, the classification of soils for OHSA purposes must be made at the time the excavation is open and can be directly observed during construction.

Where the side slopes of excavations are required to be steepened to limit the extent of the excavation, then some form of trench support may be required. Some trench excavations could be carried out using a vertically excavated, unsupported excavation (using a properly engineered trench liner box for protection, certified by an experienced engineer); or by a supported (sheeted) excavation if conditions warrant so; such as in wet areas and/or in close proximity to adjacent underground services.

The bedrock encountered at the site consists of granitic gneiss and was encountered at varying depths ranging from ground surface (noted visual outcrops during the geotechnical investigation) to greater than 7.5 m below ground surface in Borehole FY24-1. The bedrock was described as fresh and very strong based on the recovered rock cores from Boreholes FY24-1, FY25-1 and visual inspection of the outcrops noted at the site. If excavations of the bedrock are required to achieve design elevations, it is anticipated that the rock will need to be excavated using mechanical excavation methods which will be very slow due to the strength of the rock. Large hydraulic rock breakers with sufficient percussive force to break the rock will be required if blasting techniques are not allowed in the area.

#### **7.1.4 Potential for Expansive Soils**

The laboratory testing conducted on samples of the clayey soils encountered at the site measured plasticity indices ranging from 19% to 29% and moisture contents generally ranging from about 30% to 45%. Based on the laboratory testing results and the swell testing conducted on two samples of the silty clay (discussed in Section 6.2.3), the tested samples are considered to generally have a low potential for expansion based on reference to the Canadian Foundation Engineering Manual (CFEM) (Holtz and Gibbs, 1956).

## **8. Structures**

It is understood that the BESS structures, or 'cabinets', are typically supported on deep foundation systems connected to a frame at the base of the structure. Typical deep foundation systems include drilled piers (caissons) or helical piers (ground screws). Based on the subsurface conditions encountered at the site, shallow foundations could also be considered for support of the BESS structures and other lightly loaded ancillary structures, including strip footings, spread footings or conventional slab-on-grade (in areas where founded on bedrock or engineered fill). Discussion of the shallow and deep foundation options that could be considered to support the BESS structures and/or ancillary structures is provided in the following sections. Conceptual foundation details of the foundation options are provided in Appendix G.

### **8.1 Shallow Foundations**

As noted in Section 6.2, the subsurface conditions in the area of the BESS structures consist of topsoil overlying generally soft to stiff silty clay which is underlain by strong to very strong granitic gneiss bedrock. As discussed above, the upper approximately 2 m to 3 m of the silty clay is generally firm to stiff with generally lower moisture content, with the consistency becoming softer and more moist with depth (very soft to soft about 2 m to 3 m above the bedrock in the areas of thickest deposit).

Based on the subsurface conditions encountered at the site, strip and/or spread footings may be used for the proposed BESS structures and lightly loaded ancillary structures provided that the footings are founded in the upper 2 m of the silty clay, on the granitic gneiss bedrock or engineered fill placed on the bedrock at depths noted below and placed in accordance with the recommendations outlined in Section 7.1.

Based on the Ontario Provincial Standard Drawing (OPSD) 3090.010 entitled “Foundation Frost Penetration Depths for Southern Ontario”, the depth of frost penetration in the Ottawa area is approximately 1.8 m below ground surface. In order to provide adequate protection against frost damage, it is recommended that the shallow foundations be constructed a minimum of 1.8 m below finished ground surface or on bedrock (which is considered non-frost susceptible).

For strip and/or spread footings, the following preliminary geotechnical axial resistances at Ultimate Limit States (ULS) and at Serviceability Limit States (SLS, for 25 mm of settlement) may be assumed for design purposes. At the time of this report, the dimensions of the footings for the proposed structures were not provided. Therefore, a footing width of 0.5 m with a length of 6 m has been assumed for strip footings. For spread footings, the dimensions have been assumed to be 1 m by 1 m in area at a minimum depth of 1.8 m below ground surface.

**Table 8-1: Founding Elevations and Geotechnical Axial Resistances**

Foundation Element	Maximum Founding Depth Below Ground Surface (m)	Relevant Boreholes	Founding Soil	Factored Geotechnical Resistance at ULS (kPa)	Factored Geotechnical Resistance at SLS <sup>1</sup> (kPa)
BESS Structures	2.0	FY24-2 to FY24-9	Firm to Stiff Silty Clay	150	75
			Granitic Gneiss Bedrock	500	.2
Substation	2.0	FY24-1	Firm to Stiff Silty Clay	150	75
			Granitic Gneiss Bedrock	500	.2

**Note:**

1. SLS value for 25 mm of settlement.
2. SLS geotechnical resistance will be higher than the ULS resistance. Therefore, ULS will govern.

The factored geotechnical axial resistance at ULS and geotechnical reaction at SLS are dependent on the foundation size, depth, configuration and applied loads. The geotechnical resistance/reaction should, therefore, be reviewed once more detailed design information (i.e., footing size and depth) becomes available. The geotechnical resistance/reaction are based on loading applied perpendicular to the base of the footings. Where applicable, inclination of the load should be taken into account.

Where spread footings are constructed at different elevations, the difference in elevation between the individual footings should not be greater than one half the clear distance between the footings. In addition, the lower footings should be constructed first so that if it is necessary to construct the lower footings at a greater depth than anticipated, the elevation of the upper footings can be adjusted accordingly. Stepped strip footings should be constructed in accordance with the Ontario Building Code (2024), Section 9.15.3.9.

The maximum total and differential settlements are expected to be less than 25 mm and 20 mm; respectively, for footings designed, constructed and inspected as outlined above.

The native soils are susceptible to disturbance from construction activity, especially during wet or freezing weather. Care should be taken to preserve the integrity of the materials as bearing strata. It is essential that the founding surface for the footings be inspected by qualified geotechnical personnel prior to placing concrete. If the concrete for the footings cannot be placed immediately after excavation and inspection of the subgrade, it is recommended that a working mat of lean concrete be placed in the excavation to protect the integrity of the bearing stratum.

To avoid detrimental impacts from frost adhesion and heaving, the excavated areas behind any below grade foundation elements, such as the substation, should be backfilled with non-frost susceptible granular material conforming to the requirements for OPSS.MUNI 1010 Granular "B" Type I material. In areas where asphalt/concrete pavement or other hard surfacing (flatwork) will abut the structure, differential frost heaving could occur between the granular fill immediately adjacent to the structure and the more frost susceptible native materials which exist beyond the wall backfill. To reduce the severity of this differential heaving, the backfill adjacent to the wall should be placed to form a frost taper. The frost taper should be brought up to asphalt/concrete subgrade level from 1.8 m below finished exterior grade at a slope of 3 horizontal to 1 vertical, or flatter, away from the wall. The backfill materials should be placed evenly in lifts not exceeding 200 mm loose thickness. The layers should be compacted to at least 98% of the materials Standard Proctor Maximum Dry Density (SPMDD). Light compaction equipment should be used immediately adjacent to the walls; otherwise, compaction stresses on the wall may be greater than that imposed by the backfill material. The upper 0.3 m of backfill should consist of clayey material (in landscape areas) to provide a relatively low-permeability cap and the exterior grade should also be shaped to slope away from the structure.

Resistance to lateral forces/sliding resistance between the concrete footings and the subgrade should be calculated in accordance with Section 6.10.4 of the Canadian Highway and Bridge Design Code (CHBDC). The unfactored coefficient of friction,  $\tan \delta$ , for the interface between the cast-in-place concrete footing and the properly prepared subgrade can be assumed to be 0.31.

## 8.2 Slab-On-Grade

Conventional slab-on-grade foundation construction could be considered for the proposed BESS structure ‘cabinets’ at the site in areas of exposed bedrock or shallow bedrock where the near surface soils have been excavated and replaced with engineered fill. Slab-on-grade foundations could also be considered if constructed on the silty clay soils, however, the compressibility of subgrade soils could cause intolerable settlements of the slab-on-grade foundations. Therefore, design loads and settlement tolerances from the structural designer should be provided to the geotechnical engineer of record and a detailed settlement analysis carried out to determine if the calculated settlements are tolerable. The slab-on-grade foundations are considered to be suitable in areas where founded directly on the bedrock or on engineered fill placed above the bedrock following excavation of the native subsurface soils.

The design of “raft” foundations is generally governed by settlement considerations rather than bearing capacity since the design bearing pressure is generally less than the allowable bearing capacity. Differential settlements may also occur along the length of the structure supported by a raft due to the variation in loading across the raft as well as potential variable soils/rock at the base elevation, as such, reinforcing steel should be incorporated into the raft slab to help mitigate differential settlement.

The modulus of vertical subgrade reaction or soil “spring constant” is a concept used in structure engineering; however, it is not related to fundamental soil properties. The values of “spring constants” for raft design can only be evaluated following a detailed settlement analysis and should be considered approximate only. The moduli of subgrade reaction provided has been adjusted from that interpreted for a 0.3 m by 0.3 m square plate and a minimum base slab thickness of 600 mm has been used as an indicator of relative base slab stiffness and effective foundation width for calculation using spring constants. The design modulus of subgrade reaction is derived based on the assumption that the soils overlying the bedrock have been stripped and covered with 200 mm thick pad of Ontario Provincial Standard Specification (OPSS) Granular ‘A’ compacted to 100% of the Standard Proctor Maximum Dry Density (SPMDD). A typical preliminary modulus of subgrade reaction,  $k_s$ , of 10 MPa/m may be considered assuming that the subgrade is not disturbed during construction, excavation subgrade is prepared according to recommendations in this report and adequate dewatering (if required) is undertaken to ensure an undisturbed subgrade.

As noted previously, the modulus of subgrade reaction is not a fundamental nor intrinsic soil property and will vary depending on the rigidity of the slab, the thickness of the granular bedding, and the thickness, type and stiffness of the subgrade at the location/elevation of the raft slab-on-grade. Where the design is sensitive to the specific modulus value(s) and the design details of the proposed foundations for the raft is confirmed (including founding level and contact stresses at the underside of the foundation) a detailed settlement analysis will need to be carried out, from which values of modulus of subgrade reaction across the foundation can be estimated.

For predictable performance of the floor slab, the existing topsoil or organic soils, reworked soil, silty clay overlying the bedrock (if encountered within the same excavation footprint), as well as any wet or disturbed material should be removed from within the proposed BESS slab-on-grade structure area. Provisions should be made for at least 200 mm of OPSS Granular 'A' to form the base for the slab.

Any bulk fill required to raise the grade to the underside of the Granular 'A' should consist of OPSS Granular 'B' Type II. The underslab fill should be placed in maximum 300 mm thick lifts and should be compacted to at least 98% of the materials Standard Proctor Maximum Dry Density (SPMDD) using suitable vibratory compaction equipment.

## 8.3 Deep Foundations

### 8.3.1 *Drilled Pier (Caisson) Foundations*

Drilled pier foundations (caissons) can be considered for support of the proposed BESS 'cabinet' structures, substation and ancillary structures. The factored ULS bearing resistance values provided below are based on a limit state resistance factor of 0.4. Based on the stratigraphic conditions, the recommended factored axial geotechnical resistance in compression at Ultimate Limit states (ULS) and the axial geotechnical resistance at Serviceability Limit States (SLS) for 600 mm diameter caissons founded on the granitic gneiss bedrock are provided in the table below. The bottom of the pile caps are assumed to be at a minimum of 1.8 m below ground surface (frost penetration depth) in soils with a minimum pile length of 3 m bearing on the granitic gneiss bedrock. Further, the minimum required pile length is based on the embedded depth skin friction and structure loads resisting adfreeze uplift forces within the frost penetration zone. Once the design structure loads and foundation type are determined the required pile lengths can be reassessed. Due to the expected fluctuations in the bedrock surface elevation, a minimum pile length has been assumed rather than a specific elevation. The axial resistance provided in the table below is based on end-bearing resistance only. It is expected that pile lengths across the site and even within the same BESS 'module' or across the substation foundation will vary.

**Table 8-2: Preliminary Geotechnical Axial Resistances for Caissons**

Recommended Minimum Caisson Length (m) and Anticipated Founding Stratum	Factored Geotechnical Axial Resistance at ULS (kN)	Geotechnical Resistance at SLS (kN)
3.0 m Granitic Gneiss Bedrock	500	- <sup>1</sup>

**Note:**

1. ULS value will govern the design as the SLS value for 25 mm of settlement is higher than the ULS value.

An approximately 1 m thick layer of saturated silty sand was encountered above the bedrock in Borehole FY24-1. Further, the native silty clay encountered at the site is considered sensitive soil based on the shear vane undisturbed and remoulded vanes. Also, the water content measured on samples of the silty clay within about 2 m above the bedrock was above the liquid limit of the soil. Based on the SPT's, vane shear testing and Atterberg limits, the sensitive clay soils could "flow" into the auger hole during installation of the drilled pier if left unsupported. Therefore, the installation of caissons will likely require a temporary casing to provide support to the surrounding soil and the use of drilling slurry to minimize disturbance to the soil sidewalls and balance the groundwater head. Due to the anticipated water inflow, concrete must be placed in caissons using tremie techniques. That is, the concrete must be discharged at the base of the caisson excavations, and flow upward to the ground surface. The tremie discharge should be maintained a minimum of 1 m below the surface of the wet concrete during placement and as the temporary liner is withdrawn. The performance of caissons in compression will depend, to a large degree, upon the final cleaning and verification of the condition of the bedrock surface at the base of the circular pile. For the caissons acting in compression, the base of each caisson excavation must be cleaned to remove all loose cuttings to ensure that the concrete is in contact with the competent undisturbed base.

All caisson/pile caps should be founded at a minimum depth of 1.8 m or provided with an equivalent thickness of insulation below the cap for frost protection, in accordance with OPSD 3090.101 (*Foundation Frost Penetration Depths for Southern Ontario*). In addition, the bearing soil and fresh concrete should be protected from freezing during cold weather construction.

### **8.3.2 Helical (Screw) Piles**

Typically, helical (screw) piles are considered a proprietary foundation system due to variability in the use of pile materials and installation methods. Therefore, the provided design guidelines are for planning and preliminary design purposes only. Detailed design and verification of the installed capacity of helical piles is the responsibility of the proprietary foundation system designer/installer.

Helical pier foundation systems installed at the site should be augered through the overburden soils and bear on the granitic gneiss bedrock (end bearing pier). Due to the soft consistency and compressibility of the silty clay soils encountered on site, this material is not considered suitable to provide the required resistance as the applied loads on the helix would induce unacceptable settlements of the pier and, ultimately, the BESS 'cabinet' structures and 'modules'. A helical pile system specifically intended to bear directly on sound bedrock should be selected for this project as penetration of the helices into rock is not anticipated. Consideration should be given by the foundation system designer of the helical pile shaft bearing on the undulating surface (varying depth and slope) of the bedrock encountered and observed at the site as a sloping contact may affect the capacity and feasibility of the pile.

Following advancement of the helical pier to refusal on the granitic gneiss bedrock, the top of the pier/foundation would then be attached to the foundations using brackets. Pre-compression should be induced in the helical pier prior to transferring the foundation loads to minimize the amount of post-construction settlement.

As the silty clay soils encountered at the site are considered sensitive and may "flow" during installation of drilled piers, as well as the high groundwater table which would require temporary casing in order to successfully install steel reinforcing and pour concrete, helical piers may be the preferred option for the South March site to support the proposed development structures due to the following advantages:

- Minimal disturbance of sensitive clays or saturated sands;
- Do not require temporary liners, placement steel reinforcing or tremie poured concrete;
- No vibration or excess soils to dispose;
- Adaptable to various subsurface conditions;
- Installation equipment requires minimal footprint and can be installed with portable equipment (if required); and
- Can be installed shallow or deep (2 m to 60 m).

The number, size and design of the helical piles should be determined and confirmed by the supplier.

The number and size of the helical piles will need to be determined based on the loading and configuration of the support system of the BESS 'cabinet' structures. The project geotechnical information and structural loading should be provided to a specialist design-build contractor to assess the feasibility of this foundation system and to determine probable helical pile installation depths and capacities.

For preliminary design purposes, the table below provides the factored helical pile capacities based on end-bearing resistance on the granitic gneiss bedrock only (no shaft skin-friction resistance or resistance of helices founded in the overburden due to the soft consistency of the silty clay soils).

**Table 8-3: Preliminary Factored Geotechnical Axial Resistances for Helical Piles**

Recommended Minimum Caisson Length (m) and Anticipated Founding Stratum	Factored Geotechnical Axial Resistance at ULS (kN)	Geotechnical Resistance at SLS (kN)
3.0 m Granitic Gneiss Bedrock	500	_1

**Note:**

1. ULS value will govern the design as the SLS value for 25 mm of settlement is higher than the ULS value.

It is recommended that a pile load test program be completed on site prior to completion of detailed design to verify or amend capacity of the helical piles if suggested by the specialist contractor.

The actual depth of each helical pile is determined on site based on depth, torque measurements or noted refusal and load support requirements. Full time inspection of the installation of the helical piles by a geotechnical professional is recommended to confirm that the subsurface conditions are consistent with the findings of the geotechnical investigation which the design was based on.

Based on the fluctuating elevation of the bedrock across the site noted visually during the geotechnical investigation and encountered in the boreholes, it is expected that pile lengths across the site, and even within the same BESS 'module' or across the substation foundation, will vary.

**8.3.3 Additional Design and Construction Recommendations**

Construction specifications for the drilled piles should include a concrete mix designed to limit bleeding. It is the contractor's responsibility to increase individual or group pile lengths and/or increase the number of piles to compensate for any soil disturbance created by the contractor's means and methods during construction.

To minimize disturbance of foundation soils, the contractor should drill piles using temporary casings where groundwater is present. After drilling, the casing should be extracted at a slow, uniform rate, with the pull in line with the center of the shaft. We recommend the contractor review this report and adjust drilled shaft installation means and methods accordingly.

A geotechnical professional or authorized representative should be on-site to observe drilled pile installation including drilling operations as well as concrete and reinforcing steel placement. The base of the drilled piles should be clean and free of debris or loose soil prior to pouring concrete or placing reinforcing steel. Concrete should be poured promptly after drilling to reduce exposing the subsoil to water or drying conditions. If foundation bearing strata are subjected to such conditions, the soils should be reevaluated before concrete is poured.

Free-fall concrete placement is not recommended unless approved by the structural engineer. The use of a bottom dump hopper or tremie pipe should be considered to prevent potential aggregate segregation or sidewall disturbance.

## 8.4 Lateral Earth Pressures

The parameters<sup>4</sup> (unfactored) provided below may be used to calculate the lateral earth pressures acting on ancillary structures such as the substation systems for excavation support, if required:

**Table 8-4: Lateral Earth Pressure Parameters**

Soil Type	Angle of Internal Friction (Deg)	Unit Weight (kN/m <sup>3</sup> )	Coefficients of Static Lateral Earth Pressure		
			At-Rest, K <sub>o</sub>	Active, K <sub>a</sub>	Passive, K <sub>p</sub>
New Granular Fill	35	22	0.43	0.27	3.69
Silty Clay	26	21	0.56	0.39	2.56
Silty Clay (Till)	32	21	0.47	0.31	3.25

The unit weight of water may be taken as 10 kN/m<sup>3</sup>. If the structure allows for lateral yielding, active earth pressures may be used in the design of the structure(s). If the structure does not allow for lateral yielding, at-rest earth pressures should be assumed for design.

## 8.5 Transmission Line Poles

Based on the transmission pole alignment information provided to Hatch by Brookfield, it is understood that the proposed transmission line will be supported by three groups of poles extending from the BESS substation to about 170 m to the southwest where the lines will connect with existing Hydro One infrastructure. The information provided to Hatch does not contain detailed design information for the poles (alignment only) and therefore, the recommendations for the axial and lateral capacities could not be calculated at this time. It is recommended that the designer of the transmission line poles use the information provided in the following sections as input to calculate the required resistances.

<sup>4</sup> Canadian Geotechnical Society (2023). Canadian Foundation Engineering Manual, 5<sup>th</sup> Edition.

The generally soft clayey soils encountered below the frost penetration depth at the location of the proposed transmission line poles (Boreholes FY25-1 to FY25-3) will provide minimal axial and lateral resistance. Therefore, the transmission poles should be 'socketed' into the underlying granitic gneiss bedrock for a length of at least three times their diameter. It is anticipated that single caisson foundations will be installed to support each pole.

### **8.5.1 Axial and Lateral Capacity**

The ultimate axial bearing capacity of a drilled shaft in bedrock can be determined for end bearing of the pile and the downward skin friction resistance along the 'socketed' length into which the pile is embedded in the rock. For this case and based on Section 18.6 of the Canadian Foundation Engineering Manual (CFEM 2023), the axial resistance of a single pile can be derived from toe resistance only, utilizing an estimated Unconfined Compressive Strength (UCS) of the rock.

The granitic gneiss bedrock underlying the soils encountered at the site was described as fresh and very strong. Therefore, a UCS = 100 MPa may be used for end bearing axial resistance and lateral resistance. The ultimate axial capacity should be multiplied by a geotechnical resistance factor of 0.4 applied for compression.

The ultimate (unfactored) lateral resistance of the granitic gneiss bedrock may be taken as the lesser of 100 MPa or the compressive strength of the tremie concrete.

The construction contractor selected to install the caissons for the transmission line poles should be aware of the strength and character of the bedrock (UCS estimated to be greater than 100 MPa) to facilitate selection of appropriate equipment and procedures for the caisson excavation and construction.

As noted in Section 8.3.1, the native silty clay encountered overlying the bedrock at the site is sensitive soil and could "flow" into the caisson auger holes during installation if left unsupported. Therefore, the installation of caissons will likely require a temporary casing advanced to the top of the bedrock to provide support to the surrounding soil to minimize disturbance to the soil sidewalls and balance the groundwater head. If water is encountered while constructing the caissons, concrete must be placed using tremie techniques. That is, the concrete must be discharged at the base of the caisson excavations, and flow upward to the ground surface. The tremie discharge should be maintained a minimum of 1 m below the surface of the wet concrete during placement and as the temporary liner is withdrawn. The base of each caisson excavation must be cleaned to remove all loose cuttings to ensure that the concrete is in contact with the competent undisturbed base.

## **8.6 Installation of Underground Services**

### **8.6.1 Temporary Excavations**

It is assumed that the maximum depth of the underground services will require an excavation of about 2 m below the existing ground surface. At 2 m below existing ground surface, the founding soils for the proposed utilities are anticipated to be within the silty clay and silty clay till materials or on granitic gneiss bedrock. These materials are considered to be suitable for supporting the underground services provided that the integrity of the base of the trench excavations is maintained during construction. Where softened or disturbed native soils or other deleterious materials are encountered at the base of the excavations for settlement-sensitive services, these materials should be subexcavated and replaced with compacted fills approved by a geotechnical engineer.

Care should be taken to direct surface water away from any open excavations and all temporary excavations should be carried out in accordance with the Occupational Health and Safety Act (OHSA) and Regulations for Construction Projects.

In general, the groundwater level in the open boreholes upon completion of drilling was measured at a depth of about 1.0 m to 1.3 m below ground surface. The groundwater measured in the monitoring well installed in Borehole FY24-1 ranged from about 1.8 m to 2.6 m below ground surface. In general, the excavations within the native silty clay and silty clay till deposits are likely to be handled by collection via properly constructed and filtered sumps, located within the excavations, and then pumping and discharging the water to a suitable discharge point.

For trench excavations (i.e., for servicing) extending predominantly through the silty clay and silty clay till material within the upper 2 m, it is anticipated that conventional temporary open cuts may be developed with side slopes not steeper than 3 horizontal to 1 vertical (3H:1V). Where the side slopes of excavations are required to be steepened to limit the extent of the excavation, then some form of trench support will be required. Trench excavations could be carried out using a vertically excavated, unsupported excavation (using properly engineered trench liner box for protection, certified by an experienced engineer); or by supported (sheeted) excavation if conditions warrant so; such as in wet areas and/or in close proximity to adjacent underground services. It must be emphasized that a trench liner box provides protection for construction personnel but does not provide any lateral support for adjacent excavation walls, underground services or existing structures (if any). It is imperative that any underground services or existing structures adjacent to the trench excavations be accurately located prior to construction and adequate support provided where required. Steepened excavations should only be left open for as short duration as possible and completely backfilled at the end of each working day.

As noted in Section 7.1.3, the bedrock encountered at the site was described as fresh and very strong based on the recovered rock cores from Borehole FY24-1 and visual inspection of the outcrops noted at the site. If excavations of the bedrock are required for installation of underground utilities, it is anticipated that the rock will need to be excavated using mechanical excavation methods which will be very slow due to the strength of the rock. Large hydraulic rock breakers with sufficient percussive force to break the rock will be required if blasting techniques are not allowed in the area.

### **8.6.2** *Pipe Bedding and Cover*

The bedding for sewers and watermains should be compatible with the size, type and class of pipe and the surrounding subsoil and the requirements of the City of Ottawa. If granular bedding is deemed to be acceptable, then Ontario Provincial Standard Specifications (OPSS.MUNI 1010) Granular 'A' should be used from at least 150 mm below invert to springline. Clear stone should not be used as bedding material. From springline to 300 mm above invert of the pipe, sand cover could be used. All bedding and cover material should be placed in 150 mm loose lifts and uniformly compacted to at least 100% of SPMDD. Where variable fill materials, softened or disturbed native soils or other deleterious materials are encountered at the base of excavations, these materials should be sub-excavated and replaced with compacted fills approved by the geotechnical engineer.

### **8.6.3** *Trench Backfill*

The excavated materials from the Site will consist predominantly of silty clay and silty clay till. The materials encountered within the upper 2 m at the site are estimated to be near their estimated optimum water content for compaction and may be reused as backfill, however, should not be used in settlement sensitive areas (i.e., under access roads, foundations, etc.). The soils optimum water content should be maintained during placement. The soil excavated below the groundwater level may be wet and as such may require some drying prior to placement and compaction. It is expected that the excavation required for the underground utilities will not reach sufficient depth to encounter the sensitive clay soils. However, if encountered, these soil would not be suitable for use as trench backfill.

Care should be taken to maintain the water content of the soils close to/at the optimum water content for compaction during the construction operations, as difficulties with compaction and/or backfill performance would be anticipated with fine-grained soils where the water content is significantly above the optimum for compaction purposes. Soils that contain significant quantities of organics or debris are not suitable for use as trench backfill within settlement sensitive areas. In addition, any cobbles or boulders greater than 150 mm in size should be removed from the trench backfill materials. If there is a shortage of suitable in-situ material, an approved imported material such as Ontario Provincial Standard Specifications Select Subgrade Material (SSM) should be used for trench backfill. As noted above, the trench backfill materials are silty in nature and are susceptible to wetting/freezing temperatures. Backfilling during cold or wet weather is not recommended.

Trench backfill should be placed in maximum 300 mm loose lifts and uniformly compacted to at least 98% of the material's SPMDD. Soil that is frozen should not be used as backfill.

Normal post-construction settlement of the compacted trench backfill should be anticipated with the majority of such settlement taking place within about 12 months following the completion of trench backfilling operations. These settlements will be reflected at the ground surface and in gravel access road construction areas. This may be compensated for, where necessary, by placing additional granular material prior to placing the final granular lift. Post-construction settlement of the restored ground surface in off-road trench areas is also expected and should be topped-up and re-landscaped, as required.

The subgrade should be proof-rolled and inspected by qualified geotechnical personnel prior to placing the Granular 'B' subbase and additional subbase material placed as required, being consistent with the prevailing weather conditions and anticipated use by construction traffic.

It is understood that the underground cables associated with the BESS structures will require specialized backfill requirements based on the results of the soils thermal resistivity testing provided in Appendix C. Therefore, cable sizing and backfill requirements should be selected by the appropriate civil designer and is beyond the scope of the geotechnical recommendations provided in this report.

## 8.7 Access Road Design

Provided that preparation of the site is completed in accordance with recommendations stated above, the following access road structure should be suitable for construction based on subgrade conditions of silty clay and exposed bedrock.

**Table 8-5: Access Road Construction Details**

Subgrade Conditions	Pavement Layer	Material Description	Thickness (mm)
Silty Clay / Silty Clay Till	Base	OPSS.MUNI 1010 Granular 'A' <sup>1</sup>	300
	Subbase	OPSS.MUNI 1010 Granular 'B' (Type II) <sup>2</sup>	300
	Geogrid Requirement	Yes	
	Geotextile Requirement	Yes	
	<b>Total Thickness</b>	<b>600</b>	
Granitic Gneiss Bedrock	Base	OPSS.MUNI 1010 Granular A' <sup>1</sup>	250
	Subbase	OPSS.MUNI 1010 Granular 'B' (Type II) <sup>2</sup>	250
	Geogrid Requirement	No	
	Geotextile Requirement	No	
	<b>Total Thickness</b>	<b>500</b>	

**Notes:**

1. Compacted to 100% of SPMDD (ASTM D698).
2. Compacted to 98% of SPMDD.

During construction, the lift thicknesses should be placed in lifts not exceeding 200 mm loose thickness and compacted, as noted above, within 2% of the optimum moisture content. If any import fill is required, quality control shall be carried out during the placement and compaction of the fill. The fill must be placed under the supervision of a qualified Geotechnical Engineer in loose lifts not exceeding 200 mm. Field density tests must be taken on each lift of fill. Records of the field density results should be maintained and added to the construction records.

Surfaces of the roadways should be sloped at 2% or greater to promote runoff to designated surface drainage features and the subgrade should be crowned at the centreline and sloped at 3% minimum up to a maximum of 5% towards the roadway perimeter. The soils at the road subgrade level (directly beneath the topsoil) will become unstable and soft when wet or at certain times of the year, particularly the spring thaw. Due to the silty nature of the subgrade soils (in areas where bedrock is not exposed at the surface), it will be necessary to add a layer of geotextile reinforcing (e.g., Terrafix 300R or approved equivalent) between the subgrade and geogrid (Tensar BX1500 or equivalent). Adjacent sheets of geotextile should be overlapped a minimum 450 mm.

## 9. Corrosivity Analysis

Analytical laboratory testing to assess the corrosion potential of the site soils was completed on two selected soil samples from the site. The soil samples were submitted for chemical analysis of sulphate, chlorides, pH and electrical resistivity. The results of the chemical testing indicate that soil had a pH ranging from 7.10 to 7.16, resistivity ranging from 106 to 175 Ohm\*m, and a soluble sulfate concentration ranging from 6 to 10 µg/g.

The resistivity testing results indicate that the soils tested generally have a “very low” steel corrosiveness potential based on the Ministry of Transportation Gravity Pipe Design Guidelines, 2014, Table 3.2 and negligible water-soluble sulphate for sulphate attack on concrete based on Canadian Standards Association (CSA) A23.1 - Table 3. We note that a limited number of tests were carried out across the site and that corrosiveness of the site soils may vary with depth and material types.

## 10. Seismic Classification for Seismic Response

Seismic hazard is defined in the 2024 Ontario Building Code (OBC, 2024) by uniform hazard spectra (UHS) at spectral coordinates of 0.2 seconds, 0.5 seconds, 1.0 seconds and 2.0 seconds and a probability of exceedance of 2% in 50 years. The OBC method uses a site classification system defined by the average soil/bedrock properties (e.g., shear wave velocity, Standard Penetration Test (SPT) resistance, undrained soil shear strength, etc.) in the 30 m below the foundation level. There are six site classes from A to F, decreasing in ground stiffness from A, hard rock, to E, soft soil; with Site Class F used to denote problematic soils (e.g., sites underlain by thick peat deposits and/or liquefiable soils). The site class is then used to obtain acceleration and velocity-based site coefficients  $F_a$  and  $F_v$ , respectively, used to modify the UHS to account for the effects of site-specific soil conditions in design.

A geophysics investigation was conducted at the site by Simcoe Geoscience based on requests from Brookfield to further delineate the bedrock surface across the site. The geophysics scope was conducted from March 30 to April 4, 2025. The investigation included seismic refraction and Multichannel Analysis of Surface Waves (MASW) testing.

The results of the seismic refraction testing were analyzed and boreholes advanced as part of the geotechnical investigation were used to aid in interpreting the results to delineate the bedrock surface. The results of the seismic refraction testing can be found in a report prepared by Simcoe Geoscience in Appendix H.

Based on the results of the geotechnical investigation, a Site Class F is estimated for planning purposes based on the sensitivity of the underlying silty clay material of the Champlain Sea basin. However, further discussion of the Site Class is provided in the report prepared by Simcoe Geoscience in Appendix H. As noted in the report, the Site Class depends on the type of foundation chosen for the proposed BESS 'cabinets' and associated structures. Therefore, once the foundation type is chosen by the construction contractor, this information should be provided to the geotechnical engineer of record to determine the appropriate Site Class.

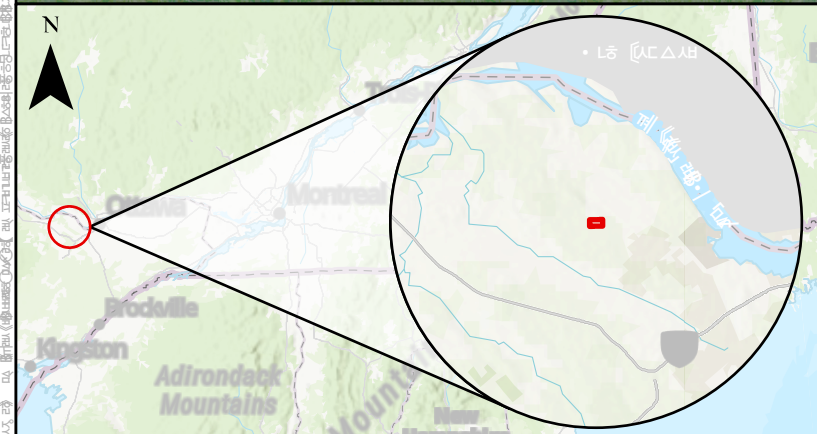

- 표기**
- 수질 측정점
  - ⊕ 수질 측정점, 수질 측정소, 수질 측정소
  - 도로
  - 레크리에이션 구역

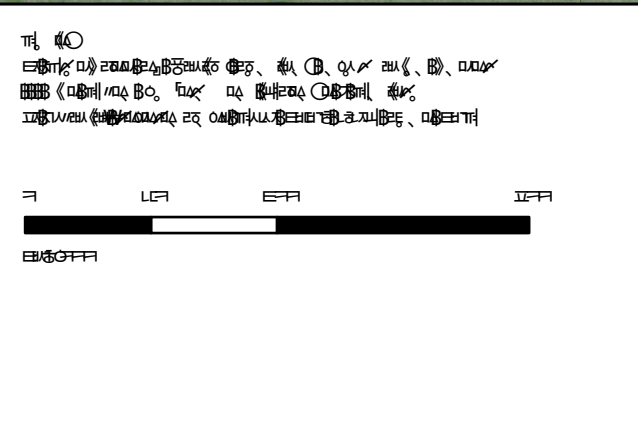

주요 내용		수질 측정점		
수질 측정점		수질 측정점		
수질 측정점		수질 측정점		
수질 측정점	수질 측정점	수질 측정점	수질 측정점	수질 측정점
수질 측정점	수질 측정점	수질 측정점	수질 측정점	수질 측정점



# Appendix A

## Record of Boreholes

# HATCH List of Abbreviations and Terms Used in the Borehole Reports

(Sheet 1)

## General

### Elevations

Elevations are referenced to datum indicated.

### Depth

All depths are given in meters (feet) measured from the ground surface unless otherwise noted.

### Sample Recovery

Indicates the length retained in millimeters (inches) in a split spoon sampler or percentage recovery of sample retained in the core barrel sampler.

### Sample Number

Samples are numbered consecutively in the order in which they were obtained in the borehole.

### Sampler Size

Dimension is in millimetres and refers to the outside diameter of the sampler.

### Sample Type

The first letter describes the sampling method and the second, the shipping container.

### Sampling Method

A – Split Tube	E – Auger
B – Thin Wall Tube	F – Wash
C – Piston Sampler	G – Shovel Grab Sample
D – Core Barrel	K – Slotted Sampler

### Shipping Container

N – Insert (split spoon)	S – Plastic Bag
O – Tube	U – Wooden Box
P – Water Content Tin	X – Plastic & PVC Sleeve (Sonic)
Q – Jar	Y – Core Box
R – Cloth Bag	Z – Discarded

### Abbreviations

N/A – Not applicable  
N/E – Not encountered  
N/O – Not observed

## Soil

### Soil Description, Label and Symbol

Soil description under the “Description” column conforms generally, but not rigorously, to the Unified Soils Classification System. For a given soil unit, defined by depth boundaries, the descriptive text constitutes the definitive soil unit description and takes precedence over both the brief label and the symbol used to graphically represent the soil unit.

### Grain Size

Clay	<0.002 mm
Silt	0.002 – 0.075 mm
Sand	0.075 – 4.75 mm
Gravel	4.75 – 75 mm
Cobbles	75 – 300 mm
Boulder	>300 mm

### Relative Quantities

Term	Example	(%)
Trace	Trace sand	1 – 10
Some	Some sand	10 – 20
With	With Sand	20 – 35
And	And sand	>35
Noun	Sand	>50

### Standard Penetration Test (SPT)

The test is carried out in accordance with ASTM D-1586 and the ‘N’ value corresponds to the sum of the number of blows required by a 63.5-kg (140-lb) hammer, dropped 760 mm (30 in.), to drive a 50-mm (2-in.) diameter split tube sampler the second and third 150 mm (6 in.) of penetration.

### Density (Granular Soils)

	N(SPT)
Very loose	0 – 4
Loose	4 – 10
Compact	10 – 30
Dense	30 – 50
Very dense	>50

### Consistency (Cohesive Soils)

	N(SPT)
Very soft	<2
Soft	2 – 4
Firm	4 – 8
Stiff	8 – 15
Very stiff	15 – 30
Hard	>30

### Plasticity/Compressibility

		Liquid Limit (%)
Low plasticity clays	Low compressibility silts	<30
Medium plasticity clays	Medium compressibility silts	30 – 50
High plasticity clays	High compressibility silts	>50

### Dilatancy

None - No visible change.  
Slow - Water appears slowly on surface of specimen during shaking and does not disappear or disappears slowly upon squeezing.  
Rapid - Water appears quickly on the surface of specimen during shaking and disappears quickly upon squeezing.

### Sensitivity

Insensitive	<2
Low	2 – 4
Medium	4 – 8
High	8 – 16
Quick	>16

## Rock

### Core Recovery

Sum of lengths of rock core recovered from a core run, divided by the length of the core run and expressed as a percentage.

### RQD (Rock Quality Designation)

Sum of lengths of hard, sound pieces of rock core equal to or greater than 100 mm from a core run, divided by the length of the core run and expressed as a percentage. Measured along centerline of core. Core fractured by drilling is considered intact. RQD normally quoted for N-size core.

### RQD (%) Rock Quality

90 - 100	Excellent
75 - 90	Good
50 - 75	Fair
25 - 50	Poor
0 - 25	Very Poor

### Grain Size

<b>Term</b>	<b>Grain Size</b>
Very coarse-grained	>60 mm
Coarse-grained	2 mm - 60 mm
Medium-grained	60 µm - 2 mm
Fine-grained	2 µm - 60 µm
Very fine-grained	< 2 µm

### Bedding

<b>Term</b>	<b>Bed Thickness</b>		
Very thickly bedded	>2 m	>6.50 ft	
Thickly bedded	600 mm - 2 m	2.00 - 6.50 ft	
Medium bedded	200 mm - 600 mm	0.65 - 2.00 ft	
Thinly bedded	60 mm - 200 mm	0.20 - 0.65 ft	
Very thinly bedded	20 mm - 60 mm	0.06 - 0.20 ft	
Laminated	6 mm - 20 mm	0.02 - 0.06 ft	
Thinly laminated	<6 mm	<0.02 ft	

### Discontinuity Frequency

Expressed as the number of discontinuities per metre or discontinuities per foot. Excludes drill-induced fractures and fragmented zones.

### Discontinuity Spacing

<b>Term</b>	<b>Average Spacing</b>		
Extremely widely spaced	>6 m	>20.00 ft	
Very widely spaced	2 m - 6 m	6.50 - 20.00 ft	
Widely spaced	600 mm - 2 m	2.00 - 6.50 ft	
Moderately spaced	200 mm - 600 mm	0.65 - 2.00 ft	
Closely spaced	60 mm - 200 mm	0.20 - 0.65 ft	
Very closely spaced	20 mm - 60 mm	0.06 - 0.20 ft	
Extremely closely spaced	<20 mm	<0.06 ft	

Note: Excludes drill-induced fractures and fragmented rock.

### Broken Zone

Zone of full diameter core of very low RQD which may include some drill-induced fractures.

### Fragmented Zone

Zone where core is less than full diameter and RQD = 0.

### Strength Term

<b>Term</b>	<b>Description</b>	<b>Unconfined Compressive Strength</b>	
		<b>(MPa)</b>	<b>(psi)</b>
Extremely weak rock	Indented by thumbnail	0.25 - 1.0	36 - 145
Very weak	Crumbles under firm blows with point of geological hammer, can be peeled by a pocket knife	1.0 - 5.0	145 - 725
Weak rock	Can be peeled by a pocket knife with difficulty, shallow indentations made by firm blow with point of geological hammer	5.0 - 25	725 - 3625
Medium strong rock	Cannot be scraped or peeled with a pocket knife, specimen can be fractured with single firm blow of geological hammer to fracture it	25 - 50	3625 - 7250
Strong rock	Specimen requires more than one blow of geological hammer to fracture it	50 - 100	7250 - 14500
Very strong rock	Specimen requires many blows of geological hammer to fracture it	100 - 250	14500 - 36250
Extremely strong rock	Specimen can only be chipped with geological hammer	>250	>36250
<b>Weathering Term</b>		<b>Description</b>	
Fresh	No Visible sign of rock material weathering		
Faintly weathered	Discoloration on major discontinuity surfaces.		
Slightly weathered	Discoloration indicates weathering of rock material and discontinuity surfaces. All the rock material may be discolored by weathering and may be somewhat weaker than in its fresh condition.		
Moderately weathered	Less than half of the rock material is decomposed and/or disintegrated to a soil. Fresh or discolored rock is present either as a continuous framework or as corestones.		
Highly weathered	More than half of the rock material is decomposed and/or disintegrated to a soil. Fresh or discolored rock is present either as a discontinuous framework or as corestones.		
Completely weathered	All rock material is decomposed and/or disintegrated to a soil. The original mass structure is still largely intact.		
Residual soil	All rock material is converted to soil. The mass structure and material fabric are destroyed. There is a large change in volume, but the soil has not been significantly transported.		

# HATCH BASIS FOR SOIL DESCRIPTION

(Based on ASTM D 2488-17, with modifications)

## UNIFIED CLASSIFICATION (in order of description)

Soil Name (BLOCK LETTERS);

Plasticity or grading characteristics for major components,

Plasticity or grading characteristics for secondary components,

Colour of soil,

Other minor components - name, plasticity or particle characteristics and colour,

Moisture conditions,

Consistency,

Structure, and

Additional observations such as ORIGIN or other significant features not relating to the composition, condition or structure of the soil.

The terms used in the unified classification are described below:

## PARTICLE SIZE DISTRIBUTION

Clay	Silt	Sand			Gravel		Cobble	Boulder
		Fine	Medium	Coarse	Fine	Coarse		
0.002m	0.075m	0.425m	2.0mm	4.75mm	19mm	75mm	300mm	

## CLASSIFICATION OF SOILS

The Classification of soils is based on particle size distribution and plasticity, in general accordance with ASTM D 2488 - 17 Standard Practice for Description and Identification of Soils

## SOIL NAME

The Soil Name is based on the grain size characteristics and plasticity. As most soils are a combination of a range of constituents, the primary soil is described and modified by minor components, as follows:

Coarse Grained Soil (<50% Clay and Silt content)		Fine Grained Soil (>50% Clay and Silt content)	
% Fines	Modifier	% Fines	Modifier
≤ 5%	Omit, or use "trace"	≤ 15%	Omit, or use "trace"
> 5% ≤ 15%	Describe as 'with clay/silt' as applicable	> 15% ≤ 30%	Describe as 'with sand/gravel' as applicable
> 15%	Prefix soil as 'silty/clayey' as applicable	> 30%	Prefix soil as 'sandy/gravelly' as applicable

## PLASTICITY

Plasticity of clay and silt, both alone and in mixtures with coarser material, are described as:

Descriptive Term	Range of Liquid Limit	Field Guide to Plasticity
Of low plasticity	≤ 35%	The thread can barely be rolled and the lump cannot be formed when drier than the plastic limit
Of medium plasticity	> 35% ≤ 50 %	The thread is easy to roll and not much time is required to reach the plastic limit. The thread cannot be rerolled after reaching the plastic limit. The lump crumbles when drier than the plastic limit
Of high plasticity	>50%	It takes considerable time rolling and kneading to reach the plastic limit. The thread can be rerolled several times after reaching the plastic limit. The lump can be formed without crumbling when drier than the plastic limit

## GRADING CHARACTERISTICS

For coarse grained soils only, grading is described as follows:

Descriptive Term	Characteristics
Well Graded	Having good representation of all particle sizes
Poorly Graded	With one or more intermediate sizes poorly represented
Gap Graded	With one or more intermediate sizes absent
Uniform	Essentially of one size

# HATCH BASIS FOR SOIL DESCRIPTION

(Based on ASTM D 2488-17, with modifications)

## PARTICLE SHAPE

The particle shape of equidimensional particles may be described as 'rounded', 'sub-rounded', 'sub-angular' or 'angular' as shown in the sketches overleaf. Two-dimensional particles with the third dimension small by comparison may be described as 'flaky' or 'platy'. One-dimensional particles with the other two dimensions small by comparison may be described as 'elongated'

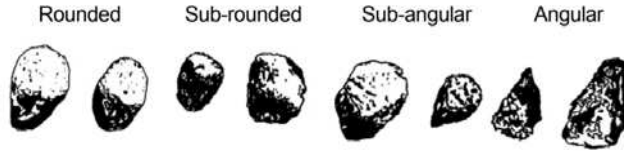

## COLOUR

The soil colour is described for soil in the 'moist' condition, using simple terms such as 'black', 'white', 'grey', 'brown', 'red', 'orange', 'yellow', 'green' or 'blue'. These may be modified as necessary by 'pale', 'dark' or 'mottled'. Borderline colours may be described as red-brown. Where a soil colour consists of a primary colour with a secondary mottling it should be described as: (primary colour) mottled (secondary colour), eg. grey mottled red-brown clay.

## MOISTURE CONDITION

Descriptive Term	General	Granular Soil	Cohesive Soil
'Dry' (D)		Cohesionless and free running	Hard and friable or powdery, well dry of plastic limit
'Moist' (M)	Soil feels cool,	Particles tend to cohere	Soil may be moulded by hand
'Wet' (W)	darkened in colour	Soil particles tend to cohere, free water forms when squeezed	Soil usually weakened and free water forms when handled

## CONSISTENCY (Cohesive soils)

The consistency of cohesive soil is based on the undrained shear strength and is generally estimated, with or without the aid of a pocket penetrometer or shear vane test.

Descriptive Term	Undrained Shear Strength (kPa)	Field Guide to Consistency
'Very Soft' (VS)	$\leq 12$	Exudes between the fingers when squeezed in hand
'Soft' (S)	$>12 \leq 25$	Can be moulded by light finger pressure
'Firm' (F)	$>25 \leq 50$	Can be moulded by strong finger pressure
'Stiff' (St)	$> 50 \leq 100$	Cannot be moulded by fingers
Very Stiff (VSt)	$>100 \leq 200$	Can be indented by thumb nail
'Hard' (H)	$>200$	Can be indented with difficulty by thumb nail

# HATCH BASIS FOR SOIL DESCRIPTION

(Based on ASTM D 2488-17, with modifications)

## DENSITY (Granular soils)

The density of a non-cohesive soil is described via the Density Index (relative density), which is generally assessed using a penetration test and published correlations.

Descriptive Term	Density Index (%)	SPT N-Value	Scala blows per 100mm	CPT $q_c$ (MPa)*
'Very Loose' (VL)	$\leq 15$	0-4	0-2	<5
'Loose' (L)	>15 $\leq$ 35	4-10	2-6	5-10
'Compact' (C)	>35 $\leq$ 65	10-30	6-16	10-15
'Dense' (D)	>65 $\leq$ 85	30-50	16-26	15-20
'Very Dense' (VD)	>85	>50	>26	>20

\* At an effective overburden pressure of 100k

## GRAPHIC SYMBOLS FOR SOILS

GRAVEL	poorly graded -		SILT	of low plasticity -		ICE -	
	well graded -			of high plasticity -			COBBLES AND BOULDERS -
SAND	poorly graded -		CLAY	of low plasticity -		ORGANIC/ PEATY SOIL -	
	well graded -			of high plasticity -		FILL/ MADE GROUND -	

Composite soil types are presented using combined symbols, eg. **Gravelly Sandy CLAY**

## GROUNDWATER OBSERVATIONS

Permanent Water Level		Inflow into Pit or Borehole		Slow Inflow/ Seepage into Pit or Borehole	
Temporary Water Level		Outflow/ Water Loss in Borehole			

## SAMPLE TYPES

Disturbed bag sample		Auger Flight Cuttings		Thin walled "undisturbed" push tube sample eg. U60, U100 etc	
Bulk Disturbed (>20kg)		Standard Penetration Test (SPT), with Disturbed Split-Spoon Sample			
Hollow Stem Auger Core		SPT (no recovery)		Sample attempted with no recovery	

### RUN AND RECOVERY

Every time the core barrel is lifted to recover a sample of the core one run is completed. The core recovery represents the ratio of core recovered to the length drilled for the corresponding core run and is expressed as a percentage. Intervals where no core is recovered are described as Core Loss and are denoted by CL.

### ROCK QUALITY DESIGNATION (RQD)

Rock Quality Designation (RQD) is an index or measure of the quality of a rock mass. RQD is determined by the ratio of sound core recovered in pieces over 100mm to the length of the core run drilled. Mechanical breaks are discounted in the calculation. RQD is not determined for extremely to highly weathered rock.

The descriptive terms assigned to RQD are as follows:

RQD (%)	Rock Description
< 25	Very Poor
25 to 50	Poor
50 to 75	Fair
75 to 90	Good
90 to 100	Excellent

### DEFECT SPACING

The defect spacing is a measure of the distance between natural discontinuities (drilling breaks are ignored), and is generally expressed in millimeters. The descriptive terms assigned to defect spacing are as follows:

Defect Spacing (mm)	Term
> 2,000	Extremely Wide
600 - 2,000	Very Wide
200 - 600	Wide
60 - 200	Moderately Wide
20 - 60	Moderately Narrow
6 - 20	Narrow
< 6	Very Narrow

### DEFECT LOG

The defect log provides a graphical description of each defect in the recovered core sample observed during logging.

### DEFECT DESCRIPTION AND COMMENTS

The defect description is an annotated description of rock defects including inclination/dip, type, infill type and amount, aperture, planarity, roughness and frequency of the defect. Other comments are also included under the defect description title.

The description format of an individual defect is as follows:

<i>Inclination</i>	<i>Type</i>	<i>Infill</i>	<i>Amount</i>	<i>Aperture</i>	<i>Planarity</i>	<i>Roughness</i>	<i>Frequency</i>
30°	J	Fe	Fi	Mw	Pl	Sm	C

### *Inclination*

For specific defects, the inclination of each individual defect is noted in degrees and is measured perpendicular to the core axis. For example, in a vertically drilled borehole, an inclination of 0° corresponds to a horizontal defect and an inclination of 90° corresponds to a vertical defect.

Continue overleaf...

### ROCK CLASSIFICATION (in order of description)

Rock Name (BLOCK LETTERS);  
 Grain Size,  
 Texture and Fabric,  
 Colour,  
 Other minor components - name, particle characteristics and colour,  
 Strength,  
 Weathering,  
 Structure of the rock,  
 Defects - type, orientation, spacing, roughness, waviness and persistency, and  
 Additional rock mass observations noted from larger exposures.

### WEATHERING

The Rock material weathering terms are defined in the Table below. The terms have been adopted from a combination of those used in AS1726-1981 and 1993.

Term	Symbol	Description
Residual Soil	RS	Soil developed on extremely weathered rock. The mass structure and substance fabric are no longer evident. There is a large change in volume but the soil has not been significantly transported.
Extremely Weathered Rock	XW	Rock substance affected by weathering to the extent that the rock exhibits soil properties, ie. it can be remoulded and classified in accordance with the Unified Soil Classification System.
Highly Weathered Rock	HW	Rock is weathered to such an extent that it shows considerable change in appearance and loss in strength. Chemical or physical decomposition of individual minerals are usually evident. The colour and strength of the original fresh rock is no longer recognisable.
Moderately Weathered Rock	MW	Rock is affected by weathering to the extent that staining extends throughout the whole of the rock substance and the original colour of the fresh rock is no longer recognisable. There is usually a significant loss in rock strength.
Slightly Weathered Rock	SW	Rock is slightly discoloured but shows little or no change of strength from fresh rock.
Fresh Rock	Fr	Rock shows no sign of decomposition or staining.

### ROCK STRENGTH

The rock strength terms defined in AS1726-1993 and generally based on Point Load index testing. In weaker rocks Unconfined Compressive Strength testing may provide a better estimate for the rock strength. In the absence of either Point Load or Unconfined Compression Strength testing, the rock strength may be based on field estimates as described in the Table below.

Term	Symbol	Point load index (MPa) $Is_{50}$	Unconfined Compression (MPa) UCS	Field guide to strength
Extremely Low	EL	$\leq 0.03$	$\leq 0.7$	Easily remoulded by hand to a material with soil properties.
Very Low	VL	$> 0.03 \leq 0.1$	$> 0.7 \leq 2.4$	Material crumbles under firm blows with sharp end of pick, can be peeled with knife, too hard to cut a triaxial sample by hand, pieces up to 30mm thick can be broken by finger pressure.
Low	L	$> 0.1 \leq 0.3$	$> 2.4 \leq 7.0$	Easily scored with a knife, indentations 1mm to 3mm show in the specimen with firm blows of the pick point, has dull sound under hammer. A piece of core 150mm long by 50mm diameter may be broken by hand. Sharp edges of core may be friable and break during handling.
Medium	M	$> 0.3 \leq 1.0$	$> 7.0 \leq 24$	Readily scored with a knife, a piece of 150mm long by 50mm diameter can be broken by hand with difficulty.
High	H	$> 1.0 \leq 3.0$	$> 24 \leq 70$	A piece of core 150mm long by 50mm diameter cannot be broken by hand but can be broken by a pick with a single firm blow, rock rings under hammer blows.
Very High	VH	$> 3.0 \leq 10$	$> 70 \leq 240$	Hand specimen break with pick after more than one blow, rock rings under hammer blows.
Extremely High	EH	$> 10$	$> 240$	Specimen requires many blows with geological pick to break through intact material, rock rings under hammer blows.

Continue overleaf...



# BOREHOLE RECORD

## FY24-1

Client: Brookfield BRP Final Depth: 9.14 m Easting: 340,593.57 m  
 Project: South March BESS Coord. System: NAD83 / MTM zone 9N Northing: 5,028,520.19 m  
 Project No: H375035 Location: Vertical Datum: CGVD2013 Elevation: 100.89 m

Contractor: OGS Rig Type: CME 45 Trackmount Bearing: Date Logged: Dec 01-Dec 02, 2024 Logged by: TV/DC  
 Driller: Jamie Hole Diam (mm): 83 Inclination: 90.00° Date Checked: Reviewed by: TWB

Elevation (m)	Depth (m)	Method	Graphic Log	Soil Description NAME (SYMBOL): gradational components including plasticity or particle characteristics (size, angularity, shape), consistency/density, colour, moisture, additional description, (GEOLOGICAL FORMATION).	Run Recovery	Sample Type	Sample Number	Recovery %	Blows	SPT N-Value	Particle Size				Lab Testing	Construction and Installation	
											GR	SA	SI	CL (FINES)			
100.0	1.0	152 mm outside dia. Hollow Stem Augers		Topsoil	SPT	SS1	88	1-2-4-5	6	■	○					0.00 - 0.92m:	
				SILTY CLAY (CL): trace sand, low plasticity, w>PL, soft to stiff, greyish brown, oxidation staining to 0.7 m, containing rootlets to 0.7 m	SPT	SS2	100	3-6-7-9	13	■	○						0.92 - 1.22m:
99.0	2.0					SPT	SS3	100	3-3-5-6	8	■	○					17 Jul 2025
						SPT	SS4	100	2-3-3-3	6	■	○					1.22 - 4.27m:
						SPT	SS5	100	1-2-2-2	4	■	○					
97.0	4.0					SPT	SS6	100	1-1-2-3	3	■	○					
						SPT	SS7	100	1-1-1-1	2	■	○					
96.0	5.0					SILTY SAND (SM): trace gravel, fine grained, poorly graded, very loose, grey, wet.	ST	ST1									UU UCS Swell
95.0	6.0			Continued on Rock Log.													

Notes: 1. Water level in open borehole measured at a depth of 1.0 m below ground surface on December 3, 2024.  
 2. Shelby Tube (T.O) sample taken at a depth of 4.6 m - 5.2 m below ground surface in a borehole advanced adjacent to Borehole FY24-1. Vane shear tests performed in the same adjacent borehole.  
 3. Monitoring well installed in an adjacent borehole about 1.5 m northwest of Borehole FY24-1 on January 16, 2025. Water level in open borehole at a depth of 2.7 m below ground surface prior to installing monitoring well.  
 4. Additional shear vane tests were conducted in the adjacent borehole.  
 5. Water level in monitoring well measured at a depth of 1.8 m below ground surface on July 17, 2025.  
 6. Water level in monitoring well measured at a depth of 2.6 m below ground surface on September 11, 2025



# BOREHOLE RECORD

**FY24-1**

<b>Client:</b> Brookfield BRP	<b>Final Depth:</b> 9.14 m	<b>Easting:</b> 340,593.57 m
<b>Project:</b> South March BESS	<b>Coord. System:</b> NAD83 / MTM zone 9N	<b>Northing:</b> 5,028,520.19 m
<b>Project No:</b> H375035	<b>Location:</b>	<b>Elevation:</b> 100.89 m
<b>Contractor:</b> OGS	<b>Rig Type:</b> CME 45 Trackmount	<b>Bearing:</b>
<b>Driller:</b> Jamie	<b>Hole Diam (mm):</b> 83	<b>Inclination:</b> 90.00°
		<b>Date Logged:</b> Dec 01-Dec 02, 2024
		<b>Date Checked:</b>
		<b>Logged by:</b> TV/DC
		<b>Reviewed by:</b> TWB

DEPTH SCALE (m)	MATERIAL PROFILE			RUN NO.	RECOVERY			WEATHERING	ROCK STRENGTH	FRACTURE FREQ. (mm)	DISCONTINUITY	NOTES & LABORATORY RESULTS	Construction and Installation
	DESCRIPTION	STRATA PLOT	ELEV. DEPT H (m)										
					TCR %	SCR %	RQD %						
0 to 6	See Soil Log.												
6 to 6.14	Granitic Gneiss Bedrock.		94.8										
6.14 to 7	Granitic Gneiss Bedrock - fresh, extremely strong, fine to medium grained, very thinly bedded, grey, black, light pink and white.		6	1	100	82	FR	R6	300				

Notes:



# BOREHOLE RECORD

**FY24-1**

<b>Client:</b> Brookfield BRP	<b>Final Depth:</b> 9.14 m	<b>Easting:</b> 340,593.57 m
<b>Project:</b> South March BESS	<b>Coord. System:</b> NAD83 / MTM zone 9N	<b>Northing:</b> 5,028,520.19 m
<b>Project No:</b> H375035 <b>Location:</b>	<b>Vertical Datum:</b> CGVD2013	<b>Elevation:</b> 100.89 m

<b>Contractor:</b> OGS	<b>Rig Type:</b> CME 45 Trackmount	<b>Bearing:</b>	<b>Date Logged:</b> Dec 01-Dec 02, 2024	<b>Logged by:</b> TV/DC
<b>Driller:</b> Jamie	<b>Hole Diam (mm):</b> 83	<b>Inclination:</b> 90.00°	<b>Date Checked:</b>	<b>Reviewed by:</b> TWB

DEPTH SCALE (m)	MATERIAL PROFILE			RUN NO.	RECOVERY									WEATHERING	ROCK STRENGTH	FRACTURE FREQ. (mm)	DEPTH	DISCONTINUITY	NOTES & LABORATORY RESULTS	Construction and Installation	
	DESCRIPTION	STRATA PLOT	ELEV. DEPT H (m)		TCR %			SCR %			ROD %										TYPE AND SURFACE DESCRIPTION
					20	40	80	20	40	80	20	40	80								
9	Granitic Gneiss Bedrock - fresh, extremely strong, fine to medium grained, very thinly bedded, grey, black, light pink and white.		91.86	2	100																
9.14	End of corehole at 9.14 m.		9.14																		
10																					
11																					
12																					
13																					
14																					
15																					
16																					

Notes:

Sheet 2 of 2



# BOREHOLE RECORD

**FY24-2**

<b>Client:</b> Brookfield BRP	<b>Final Depth:</b> 1.20 m	<b>Easting:</b> 340,428.35 m
<b>Project:</b> South March BESS	<b>Coord. System:</b> NAD83 / MTM zone 9N	<b>Northing:</b> 5,028,632.28 m
<b>Project No:</b> H375035	<b>Location:</b>	<b>Elevation:</b> 100.19 m

<b>Contractor:</b> OGS	<b>Rig Type:</b> CME 45 Trackmount	<b>Bearing:</b>	<b>Date Logged:</b> Dec 03, 2024	<b>Logged by:</b> TV/DC
<b>Driller:</b> Jamie	<b>Hole Diam (mm):</b> 83	<b>Inclination:</b> 90.00°	<b>Date Checked:</b>	<b>Reviewed by:</b> TWB

Elevation (m)	Depth (m)	Method	Graphic Log	Soil Description	Run Recovery	Sample Type	Sample Number	Recovery %	Blows	SPT N-Value	Particle Size	Lab Testing
99.0	1.0	152 mm outside dia. Hollow Stem Augers		<p><b>Soil Description</b></p> <p>NAME (SYMBOL): gradational components including plasticity or particle characteristics (size, angularity, shape), consistency/density, colour, moisture, additional description, (GEOLOGICAL FORMATION).</p> <p>Topsoil</p> <p>SILTY CLAY (CL): trace sand, low plasticity, w&gt;PL, soft to very stiff, greyish brown, oxidation staining, containing rootlets to 0.7 m, reworked</p> <p>- silty sand seams below 0.7 m</p>	SPT	SS1	75	1-1-2.4	3	■		
99.0	1.0				SPT	SS2	100	8-10-13-50	23	■	▲	
98.0	2.0			1.20 m END OF BOREHOLE Auger Refusal								
97.0	3.0											
96.0	4.0											
95.0	5.0											
94.0	6.0											
93.0	7.0											
92.0	8.0											

Notes: 1. Borehole dry upon completion of drilling

Sheet 1 of 1



# BOREHOLE RECORD

## FY24-3

**Client:** Brookfield BRP      **Final Depth:** 2.85 m  
**Project:** South March BESS      **Coord. System:** NAD83 / MTM zone 9N  
**Project No:** H375035      **Location:**      **Vertical Datum:** CGVD2013

**Easting:** 340,470.80 m  
**Northing:** 5,028,685.75 m  
**Elevation:** 99.04 m

**Contractor:** OGS      **Rig Type:** CME 45 Trackmount      **Bearing:**      **Date Logged:** Dec 03, 2024      **Logged by:** TV/DC  
**Driller:** Jamie      **Hole Diam (mm):** 83      **Inclination:** 90.00°      **Date Checked:**      **Reviewed by:** TWB

Elevation (m)	Depth (m)	Method	Graphic Log	Soil Description NAME (SYMBOL): gradational components including plasticity or particle characteristics (size, angularity, shape), consistency/density, colour, moisture, additional description, (GEOLOGICAL FORMATION).	Run Recovery	Sample Type	Sample Number	Recovery %	Blows	SPT N-Value	MC (%)				PL & LL (%)				Particle Size GR SA SI CL (FINES)	Lab Testing			
											10	20	30	40	10	20	30	40					
98.5	0.5	152 mm outside dia. Hollow Stem Augers		Topsoil		SPT	SS1	63	1-3-4-5	7													
98.0	1.0			SILTY CLAY (CL): trace sand, low plasticity, firm to stiff, greyish brown, oxidation staining to 1.5 m, containing organics and rootlets to 0.7 m, reworked to 0.7 m		SPT	SS2	100	4-5-4-7	9													
97.0	2.0					SPT	SS3	100	5-6-6-6	12													
96.5	2.5					SPT	SS4	100	4-3-3-2	6													
96.0	3.0					SPT	SS5	100	1-5-50	55													
96.0	3.0			2.85 m END OF BOREHOLE Auger Refusal																			
95.0	4.0																						
94.0	5.0																						
93.0	6.0																						
92.0	7.0																						
91.0	8.0																						

Notes: 1. Borehole dry upon completion of drilling



# BOREHOLE RECORD

## FY24-4

<b>Client:</b> Brookfield BRP	<b>Final Depth:</b> 1.05 m	<b>Easting:</b> 340,502.04 m
<b>Project:</b> South March BESS	<b>Coord. System:</b> NAD83 / MTM zone 9N	<b>Northing:</b> 5,028,617.03 m
<b>Project No:</b> H375035	<b>Location:</b>	<b>Vertical Datum:</b> CGVD2013
<b>Elevation:</b> 100.10 m		

<b>Contractor:</b> OGS	<b>Rig Type:</b> CME 45 Trackmount	<b>Bearing:</b>	<b>Date Logged:</b> Dec 03, 2024	<b>Logged by:</b> TV/DC
<b>Driller:</b> Jamie	<b>Hole Diam (mm):</b> 83	<b>Inclination:</b> 90.00°	<b>Date Checked:</b>	<b>Reviewed by:</b> TWB

Elevation (m)	Depth (m)	Method	Graphic Log	Soil Description	Run Recovery	Sample Type	Sample Number	Recovery %	Blows	SPT N-Value	Particle Size				Lab Testing
											GR	SA	SI	CL (FINES)	
		152 mm outside dia. Hollow Stem Augers	Topsoil	NAME (SYMBOL): gradational components including plasticity or particle characteristics (size, angularity, shape), consistency/density, colour, moisture, additional description, (GEOLOGICAL FORMATION).											
	1.0			SILTY SAND (SM): trace gravel, medium grained, poorly graded, compact, moist, brown	SPT	SS1	63		1-3-10.8	13					
99.0	1.0			SANDY SILTY CLAY: trace gravel, low plasticity, w>PL, brown, oxidation staining, reworked	SPT	SS2	33		5-19-50	69					
	1.05			1.05 m END OF BOREHOLE Auger Refusal											
98.0	2.0														
97.0	3.0														
96.0	4.0														
95.0	5.0														
94.0	6.0														
93.0	7.0														
92.0	8.0														

Notes: 1. Borehole dry upon completion of drilling



# BOREHOLE RECORD

## FY24-5

Client: Brookfield BRP Final Depth: 7.55 m  
 Project: South March BESS Coord. System: NAD83 / MTM zone 9N  
 Project No: H375035 Location: Vertical Datum: CGVD2013

Contractor: OGS Rig Type: CME 45 Trackmount Bearing: Date Logged: Dec 02, 2024 Logged by: TV/DC  
 Driller: Jamie Hole Diam (mm): 83 Inclination: 90.00° Date Checked: Reviewed by: TWB

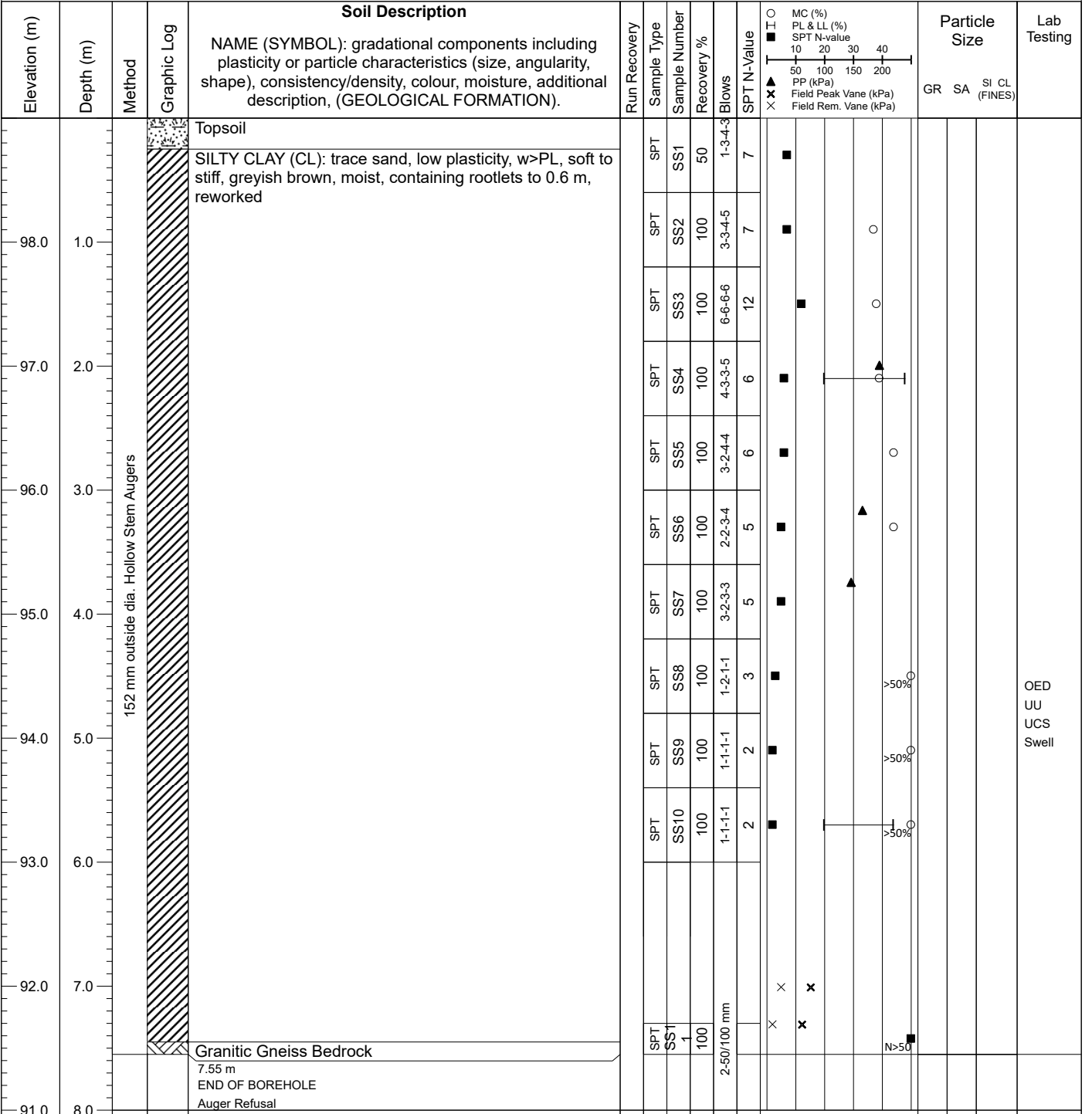

Notes: 1. Water level in open borehole measured at a depth of 1.3m below ground surface upon completion of drilling.  
 2. Shelby Tube (T.O) sample taken at a depth of 4.6m - 5.2m below ground surface in a borehole advanced in adjacent to Borehole FY24-5. Vane shear tests performed in the same adjacent borehole.



# BOREHOLE RECORD

## FY24-6

**Client:** Brookfield BRP      **Final Depth:** 3.55 m  
**Project:** South March BESS      **Coord. System:** NAD83 / MTM zone 9N  
**Project No:** H375035      **Location:**      **Vertical Datum:** CGVD2013

**Easting:** 340,644.90 m  
**Northing:** 5,028,607.61 m  
**Elevation:** 100.43 m

**Contractor:** OGS      **Rig Type:** CME 45 Trackmount      **Bearing:**      **Date Logged:** Dec 01, 2024      **Logged by:** TV/DC  
**Driller:** Jamie      **Hole Diam (mm):** 83      **Inclination:** 90.00°      **Date Checked:**      **Reviewed by:** TWB

Elevation (m)	Depth (m)	Method	Graphic Log	Soil Description	Run Recovery	SPT	Sample Type	Sample Number	Recovery %	Blows	SPT N-Value	Particle Size				Lab Testing	
												GR	SA	SI	CL (FINES)		
				Topsoil													
99.0	1.0	152 mm outside dia. Hollow Stem Augers		SILTY CLAY (CL): trace sand, low plasticity, w>PL, firm to stiff, greyish brown, moist, oxidation staining to 0.6 m, containing rootlets to 0.6 m, reworked		SPT	SS1	58	1-1-4-5	5							
								SPT	SS2	100	3-4-5-7	9					
98.0	2.0							SPT	SS3	100	3-4-3-7	7					
								SPT	SS4	100	3-3-4-3	7					
97.0	3.0					SILTY CLAY TILL (CL): trace sand, trace gravel, low plasticity, w~PL, greyish brown, moist		SPT	SS5	91	11-8-20-50/100 hmt	28					
96.0	4.0			3.55 m END OF BOREHOLE Auger Refusal													
95.0	5.0																
94.0	6.0																
93.0	7.0																
92.0	8.0																

Notes: 1. Water level in open borehole at a depth of 1.1m below ground surface upon completion of drilling



# BOREHOLE RECORD

## FY24-7

Client: Brookfield BRP Final Depth: 4.65 m Easting: 340,719.30 m  
 Project: South March BESS Coord. System: NAD83 / MTM zone 9N Northing: 5,028,576.59 m  
 Project No: H375035 Location: Vertical Datum: CGVD2013 Elevation: 103.20 m

Contractor: OGS Rig Type: CME 45 Trackmount Bearing: Date Logged: Dec 01, 2024 Logged by: TV/DC  
 Driller: Jamie Hole Diam (mm): 83 Inclination: 90.00° Date Checked: Reviewed by: TWB

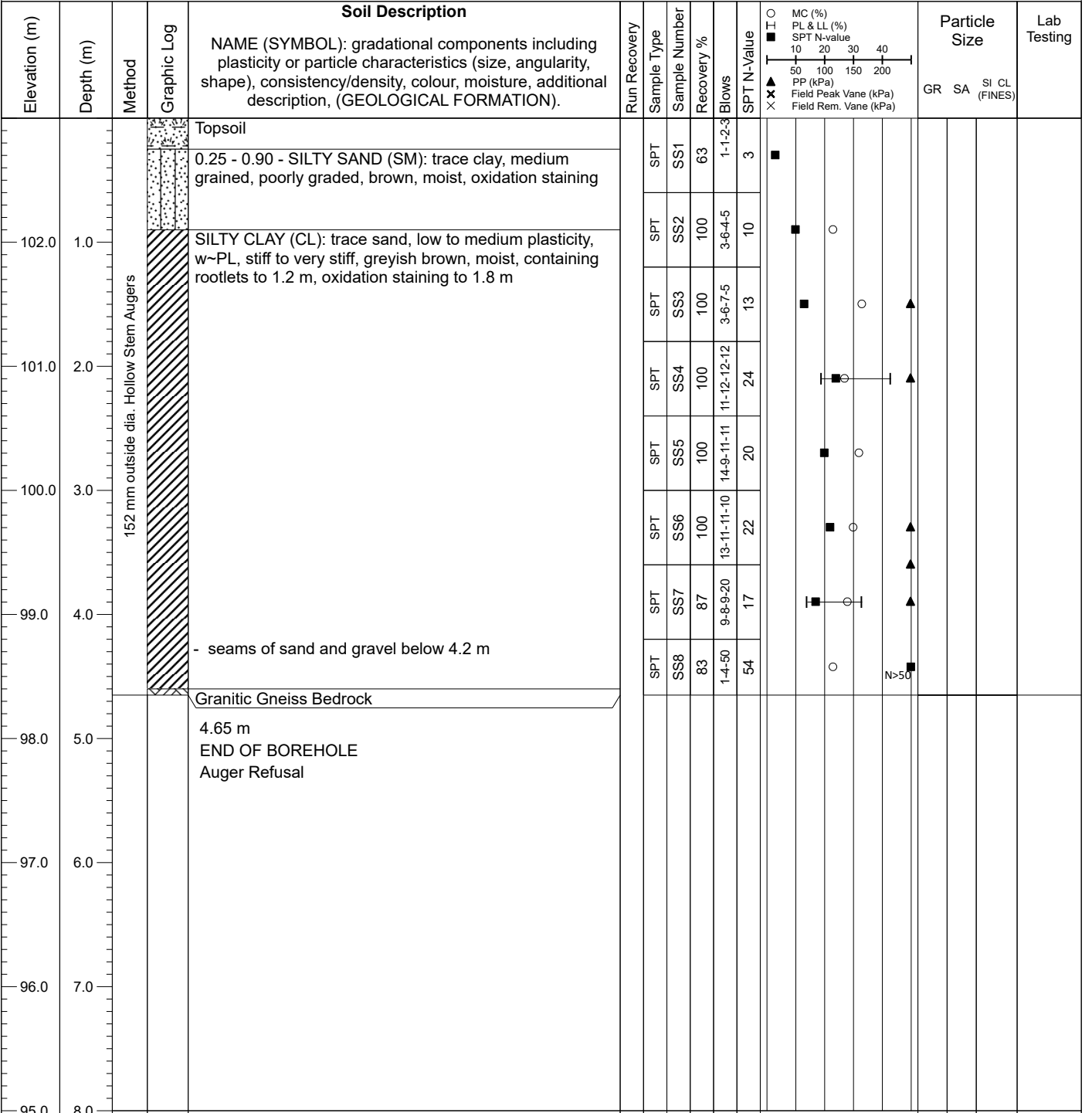

Notes: 1. Borehole dry upon completion of drilling

Sheet 1 of 1



# BOREHOLE RECORD

**FY24-8**

<b>Client:</b> Brookfield BRP	<b>Final Depth:</b> 0.75 m	<b>Easting:</b> 340,657.27 m
<b>Project:</b> South March BESS	<b>Coord. System:</b> NAD83 / MTM zone 9N	<b>Northing:</b> 5,028,511.78 m
<b>Project No:</b> H375035	<b>Location:</b>	<b>Elevation:</b> 102.89 m

<b>Contractor:</b> OGS	<b>Rig Type:</b> CME 45 Trackmount	<b>Bearing:</b>	<b>Date Logged:</b> Dec 03, 2024	<b>Logged by:</b> TV/DC
<b>Driller:</b> Jamie	<b>Hole Diam (mm):</b> 83	<b>Inclination:</b> 90.00°	<b>Date Checked:</b>	<b>Reviewed by:</b> TWB

Elevation (m)	Depth (m)	Method	Graphic Log	Soil Description NAME (SYMBOL): gradational components including plasticity or particle characteristics (size, angularity, shape), consistency/density, colour, moisture, additional description, (GEOLOGICAL FORMATION).	Run Recovery	SPT	Sample Type	Sample Number	Recovery %	Blows	SPT N-Value	Particle Size				Lab Testing
												GR	SA	SI	CL (FINES)	
		outside dia. 152 mm . Hollow Stem		Topsoil												
100.0	1.0			SILTY CLAY (CL): trace sand, low plasticity, w>PL, brown, moist, containing rootlets, reworked			SS1	25	100	1-2-4-5	6					
				0.75 m END OF BOREHOLE Auger and Split-Spoon Refusal			SS4	100	100	50/150 mm						
99.0	2.0															
98.0	3.0															
97.0	4.0															
96.0	5.0															
95.0	6.0															
94.0	7.0															
93.0	8.0															

Notes:

Sheet 1 of 1



# BOREHOLE RECORD

## FY24-9

**Client:** Brookfield BRP      **Final Depth:** 3.60 m  
**Project:** South March BESS      **Coord. System:** NAD83 / MTM zone 9N  
**Project No:** H375035      **Location:**      **Vertical Datum:** CGVD2013

**Easting:** 340,667.29 m  
**Northing:** 5,028,663.08 m  
**Elevation:** 100.20 m

**Contractor:** OGS      **Rig Type:** CME 45 Trackmount      **Bearing:**      **Date Logged:** Dec 03, 2024      **Logged by:** TV/DC  
**Driller:** Jamie      **Hole Diam (mm):** 83      **Inclination:** 90.00°      **Date Checked:**      **Reviewed by:** TWB

Elevation (m)	Depth (m)	Method	Graphic Log	Soil Description NAME (SYMBOL): gradational components including plasticity or particle characteristics (size, angularity, shape), consistency/density, colour, moisture, additional description, (GEOLOGICAL FORMATION).	Run Recovery	Sample Type	Sample Number	Recovery %	Blows	SPT N-Value	Particle Size				Lab Testing			
											GR	SA	SI	CL (FINES)				
99.5	0.5	152 mm outside dia. Hollow Stem Augers		Topsoil		SPT	SS1	88	1-2-5-6	7								
99.0	1.0			SILTY CLAY (CL): trace sand, low plasticity, w>PL, brown, moist, oxidation staining		SPT	SS2	100	8-14-12-13	26								
98.0	2.0					SPT	SS3	100	14-14-14-50	28								
98.0	2.0					SPT	SS4	100	19-15-14-12	29								
97.0	3.0					SPT	SS5	88	9-9-8-8	17								
97.0	3.0					SPT	SS6	75	5-4-3-50	7								
				- seams of sand and gravel below 3.1 m														
				End of hole at 3.60 m.														
96.0	4.0																	
95.0	5.0																	
94.0	6.0																	
93.0	7.0																	
92.0	8.0																	

Notes:

Sheet 1 of 1



# BOREHOLE RECORD

**FY25-1**

<b>Client:</b> Brookfield BRP	<b>Final Depth:</b> 10.55 m	<b>Easting:</b> 340483.99 m
<b>Project:</b> Trail Road BESS	<b>Coord. System:</b> NAD83 / UTM zone 9N	<b>Northing:</b> 5028338.15 m
<b>Project No:</b> H375035	<b>Location:</b>	<b>Vertical Datum:</b> CGVD2013
<b>Contractor:</b> OGS	<b>Rig Type:</b> CME 45 Trackmount	<b>Bearing:</b>
<b>Driller:</b> M/J	<b>Hole Diam (mm):</b> 83	<b>Inclination:</b>
<b>Date Logged:</b> Jul 22, 2025		<b>Logged by:</b> AF/TVH
<b>Date Checked:</b> Aug 25, 2025		<b>Reviewed by:</b> TWB

Elevation (m)	Depth (m)	Method	Graphic Log	Soil Description NAME (SYMBOL): gradational components including plasticity or particle characteristics (size, angularity, shape), consistency/density, colour, moisture, additional description, (GEOLOGICAL FORMATION).	Sample Type	Sample Number	Recovery %	Blows	SPT N-Value	Particle Size				Lab Testing		
										MC (%)	PL & LL (%)	SPT N-value	PP (kPa)		Field Peak Vane (kPa)	Field Rem. Vane (kPa)
101.0	0.0	Hollow Stem Auger		TOPSOIL	SPT	1	92	1-1-4-4	5							
100.0	1.0			SILTY CLAY (CL): trace sand, soft to stiff, low plasticity, brown, w~PL, containing oxidation staining and rootlets to 0.6 m	SPT	2	100	3-7-5-5	12							
99.0	2.0			w>PL below 1.8 m	SPT	3	100	6-8-6-6	14				0	1	45	54
98.0	3.0				SPT	4	100	6-7-5-6	12							
97.0	4.0			grey below 3.8 m	SPT	5	100	4-4-4-4	8							
96.0	5.0				SPT	6	100	3-3-2-2	5							
95.0	6.0				SPT	7	100	1-1-1-1	2							
94.0	7.0				SPT	8	100	1-1-1-1	2							
93.0	8.0				SPT	9	0	6-50/150 mm	1-1-1-1	R						

Notes:

Sheet 1 of 3



# BOREHOLE RECORD

**FY25-1**

<b>Client:</b> Brookfield BRP	<b>Final Depth:</b> 10.55 m	<b>Easting:</b> 340483.99 m
<b>Project:</b> Trail Road BESS	<b>Coord. System:</b> NAD83 / UTM zone 9N	<b>Northing:</b> 5028338.15 m
<b>Project No:</b> H375035 <b>Location:</b>	<b>Vertical Datum:</b> CGVD2013	<b>Elevation:</b> 101.35 m
<b>Contractor:</b> OGS <b>Rig Type:</b> CME 45 Trackmount	<b>Bearing:</b>	<b>Date Logged:</b> Jul 22, 2025 <b>Logged by:</b> AF/TVH
<b>Driller:</b> M/J <b>Hole Diam (mm):</b> 83	<b>Inclination:</b>	<b>Date Checked:</b> Aug 25, 2025 <b>Reviewed by:</b> TWB

DEPTH SCALE (m)	MATERIAL PROFILE			RUN NO.	RECOVERY									WEATHERING	ROCK STRENGTH	FRACTURE FREQ. (mm)	DEPTH	DISCONTINUITY	TYPE AND SURFACE DESCRIPTION	NOTES & LABORATORY RESULTS
	DESCRIPTION	STRATA PLOT	ELEV. DEPTH (m)		TCR %			SCR %			ROD %									
					20	40	80	20	40	80	20	40	80							
0 to 5.70	See Soil Log.																			
5.70 to 95.65	Granitic Gneiss Bedrock - fresh, very strong, fine to medium grained, very thinly bedded, grey, black, light pink and white.		95.65 5.70	1	100	94	85													

Notes: \_\_\_\_\_

Sheet 2 of 3





# BOREHOLE RECORD

**FY25-2**

<b>Client:</b> Brookfield BRP	<b>Final Depth:</b> 2.55 m	<b>Easting:</b> 340488.79 m
<b>Project:</b> Trail Road BESS	<b>Coord. System:</b> NAD83 / UTM zone 9N	<b>Northing:</b> 5028353.32 m
<b>Project No:</b> H375035	<b>Location:</b>	<b>Vertical Datum:</b> CGVD2013
<b>Contractor:</b> OGS	<b>Rig Type:</b> CME 45 Trackmount	<b>Bearing:</b>
<b>Driller:</b> M/J	<b>Hole Diam (mm):</b> 83	<b>Inclination:</b>
	<b>Date Logged:</b> Jul 23, 2025	<b>Logged by:</b> AF/TVH
	<b>Date Checked:</b> Aug 25, 2025	<b>Reviewed by:</b> TWB

Elevation (m)	Depth (m)	Method	Graphic Log	Soil Description NAME (SYMBOL): gradational components including plasticity or particle characteristics (size, angularity, shape), consistency/density, colour, moisture, additional description, (GEOLOGICAL FORMATION).	Sample Type	Sample Number	Recovery %	Blows	SPT N-Value	Particle Size		Lab Testing
										GR	SA SI CL (FINES)	
101.0	0.0			TOPSOIL	SPT	1	33	2-3-4-5	7			
100.0	1.0			SILTY CLAY (CL): trace sand, low plasticity, firm to very stiff, brown, w~PL, containing oxidation staining and rootlets to 0.6 m - w>PL below 0.6 m	SPT	2	100	3-4-5-7	9			
99.0	2.0				SPT	3	100	5-7-10-7	17			
98.0	3.0				SPT	4	100	mm6-6-6-3	12			
97.0	4.0				(SPT)	5	0	50/150	R			
96.0	5.0			End of hole at 2.55 m. Borehole terminated upon refusal on inferred bedrock								
95.0	6.0											
94.0	7.0											
93.0	8.0											

Notes:



# BOREHOLE RECORD

**FY25-3**

<b>Client:</b> Brookfield BRP	<b>Final Depth:</b> 5.20 m	<b>Easting:</b> 340502.84 m
<b>Project:</b> Trail Road BESS	<b>Coord. System:</b> NAD83 / UTM zone 9N	<b>Northing:</b> 5028398.85 m
<b>Project No:</b> H375035	<b>Location:</b>	<b>Elevation:</b> 101.11 m
<b>Contractor:</b> OGS	<b>Rig Type:</b> CME 45 Trackmount	<b>Bearing:</b>
<b>Driller:</b> M/J	<b>Hole Diam (mm):</b> 83	<b>Inclination:</b>
	<b>Date Logged:</b> Jul 23, 2025	<b>Logged by:</b> AF/TVH
	<b>Date Checked:</b> Aug 25, 2025	<b>Reviewed by:</b> TWB

Elevation (m)	Depth (m)	Method	Graphic Log	Soil Description NAME (SYMBOL): gradational components including plasticity or particle characteristics (size, angularity, shape), consistency/density, colour, moisture, additional description, (GEOLOGICAL FORMATION).	Sample Type	Sample Number	Recovery %	Blows	SPT N-Value	Particle Size		Lab Testing
										GR	SA SI CL (FINES)	
101.0				TOPSOIL	SPT	1	83	2-3-5-5	8			
	1.0			SILTY CLAY (CH): trace sand, high plasticity, firm to very stiff, brown, w~PL, containing oxidation staining and rootlets to 0.6 m	SPT	2	100	4-5-6-7	11			
100.0				- w>PL below 1.2 m	SPT	3	100	6-7-7-9	14			
	2.0				SPT	4	100	6-5-5-5	10			
99.0					SPT	5	100	5-5-4-3	9			
	3.0				SPT	6	100	5-5-5-4	10			
98.0					SPT	7	100	2-1-1-1	2			
	4.0			- grey below 4.3 m	SPT	8	100	mm-1-1-1	2			
97.0					SPT	9	0	50/100	R			
	5.0			End of hole at 5.20 m. Borehole terminated upon refusal on inferred bedrock								
96.0												
	6.0											
95.0												
	7.0											
94.0												
	8.0											

Notes:

Sheet 1 of 1



# BOREHOLE RECORD

## FY25-4

<b>Client:</b> Brookfield BRP	<b>Final Depth:</b> 0.45 m	<b>Eastings:</b> 340433.41 m
<b>Project:</b> Trail Road BESS	<b>Coord. System:</b> NAD83 / UTM zone 9N	<b>Northings:</b> 5028549.33 m
<b>Project No:</b> H375035	<b>Location:</b>	<b>Elevation:</b> 100.78 m
<b>Contractor:</b> OGS	<b>Rig Type:</b> CME 45 Trackmount	<b>Bearing:</b>
<b>Driller:</b> M/J	<b>Hole Diam (mm):</b> 83	<b>Inclination:</b>
	<b>Date Logged:</b> Jul 23, 2025	<b>Logged by:</b> AF/TVH
	<b>Date Checked:</b> Aug 25, 2025	<b>Reviewed by:</b> TWB

Elevation (m)	Depth (m)	Method	Graphic Log	Soil Description NAME (SYMBOL): gradational components including plasticity or particle characteristics (size, angularity, shape), consistency/density, colour, moisture, additional description, (GEOLOGICAL FORMATION).	Sample Type	Sample Number	Recovery %	Blows 2.5-6.50/0 mm	SPT N-Value	Particle Size				Lab Testing	
										MC (%)	PL & LL (%)	SPT N-value	PP (kPa)		Field Peak Vane (kPa)
100.0	0.0			TOPSOIL	SPT	1	100	11							
100.0	0.0			SILTY CLAY (CL): trace sand, low plasticity, stiff, brown, w~PL, containing oxidation staining and rootlets End of hole at 0.45 m. Borehole terminated upon refusal on inferred bedrock											

Notes:

# Appendix B

## Geotechnical Laboratory Testing

# Particle Size Distribution (Gradation) of Soils Using Sieve and Hydrometer Analysis



ASTM D6913-17 and D7928-17

Date: January 13.2025

Project Number: H375142

Project: South March BESS

Brookfield BRP

Brookfield Place, Suite 100, 181 Bay St. Toronto ON.

M5J 2T3

Attn: Ted Beadle

<b>Sample</b>	SS3	<b>Depth</b>	5ft - 7ft
<b>Source</b>	FY24-1		

Sieve (mm)	% Passing	Sieve (mm)	% Passing	Size (mm)	% Passing
75	100.0	4.75	100.0	0.0350	94.5
63	100.0	2	100.0	0.0255	89.6
53	100.0	0.850	99.9	0.0166	84.6
37.5	100.0	0.425	99.8	0.0099	78.7
26.5	100.0	0.250	99.6	0.0071	74.8
19	100.0	0.106	99.1	0.0052	70.9
13.2	100.0	0.075	98.4	0.0027	62.0
9.5	100.0			0.0012	52.2

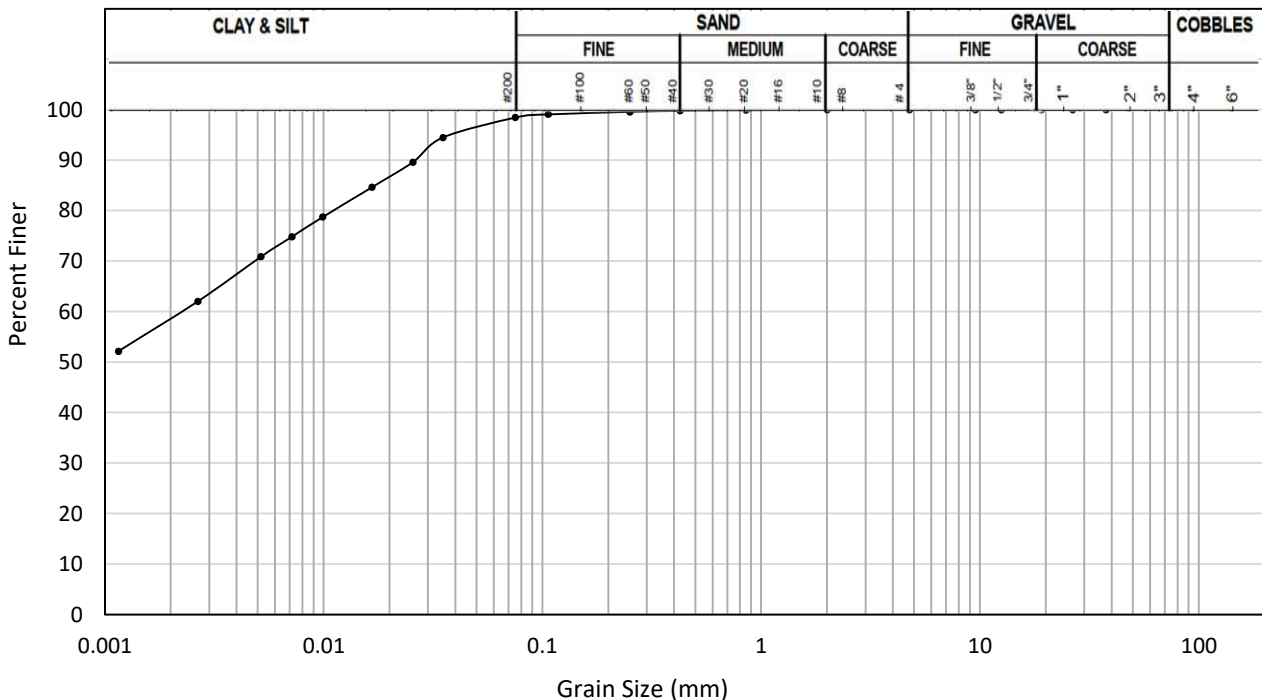

**Comments:** Whole sample, tested as received. 100% passing the 2mm sieve.

**Reported By:** D. Cuellar, Technician  
**Reviewed By:** R.Serluca, Lab Manager

**Date:** January 13.2025  
**Date:** February 5.2025

Notice: The test data given herein pertain to the sample provide, and may not be applicable to other production zones/periods. This report constitutes a testing service only. Interpretation of the data given here may be provided upon request.

Suite 300, 4342 Queen St, Niagara Falls, Ontario, Canada, L2E 7J7 Tel:1 (905) 374 5200 [www.hatch.com](http://www.hatch.com).

©Hatch 2017 All rights reserved, including all rights relating to the use of this document and its contents.

# Liquid Limit, Plastic Limit and Plasticity Index of Soils.



## ASTM D4318-17 Method A

Date: January 13.2025

Project Number: H375142

Project: South March BESS

Brookfield BRP

Brookfield Place, Suite 100, 181 Bay St. Toronto

ON. M5J 2T3

Attn: Ted Beadle

<b>Sample</b>	SS3	<b>Depth</b>	5ft - 7ft
<b>Source</b>	FY24-1		

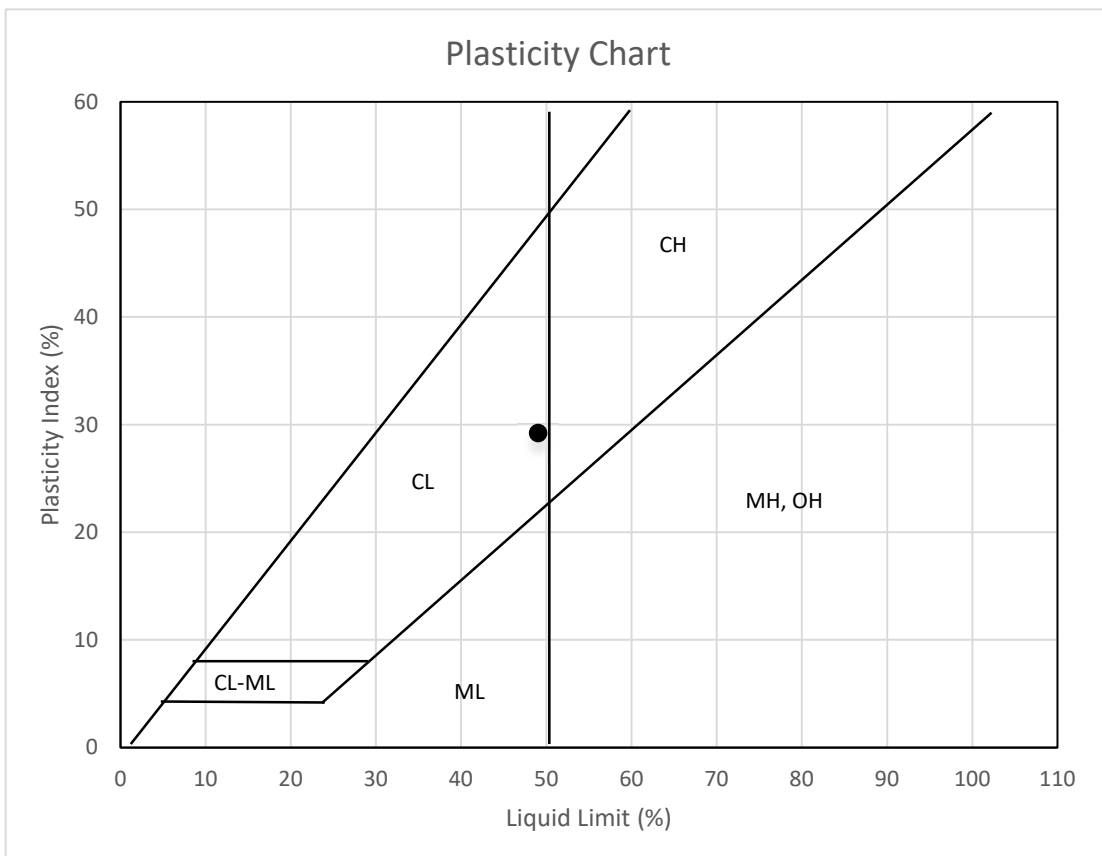

Liquid Limit	49%
Plastic Limit	20%
Plasticity Index	29%

**Comments:** Silty-Clay, grey.

**Reported By:** D. Cuellar, Technician

**Date:** January 13.2025

**Reviewed By:** R. Serluca, Lab Manager

**Date:** February 5. 2025

Notice: The test data given herein pertain to the sample provide, and may not be applicable to other production zones/periods. This report constitutes a testing service only. Interpretation of the data given here may be provided upon request.

Suite 300, 4342 Queen St, Niagara Falls, Ontario, Canada, L2E 7J7 Tel:1 (905) 374 5200 [www.hatch.com](http://www.hatch.com).

©Hatch 2017 All rights reserved, including all rights relating to the use of this document and its contents.

# Liquid Limit, Plastic Limit and Plasticity Index of Soils.



## ASTM D4318-17 Method A

Date: January 13.2025

Project Number: H375142

Project: South March BESS

Brookfield BRP

Brookfield Place, Suite 100, 181 Bay St. Toronto

ON. M5J 2T3

Attn: Ted Beadle

<b>Sample</b>	SS5	<b>Depth</b>	10ft - 12ft
<b>Source</b>	FY24-1		

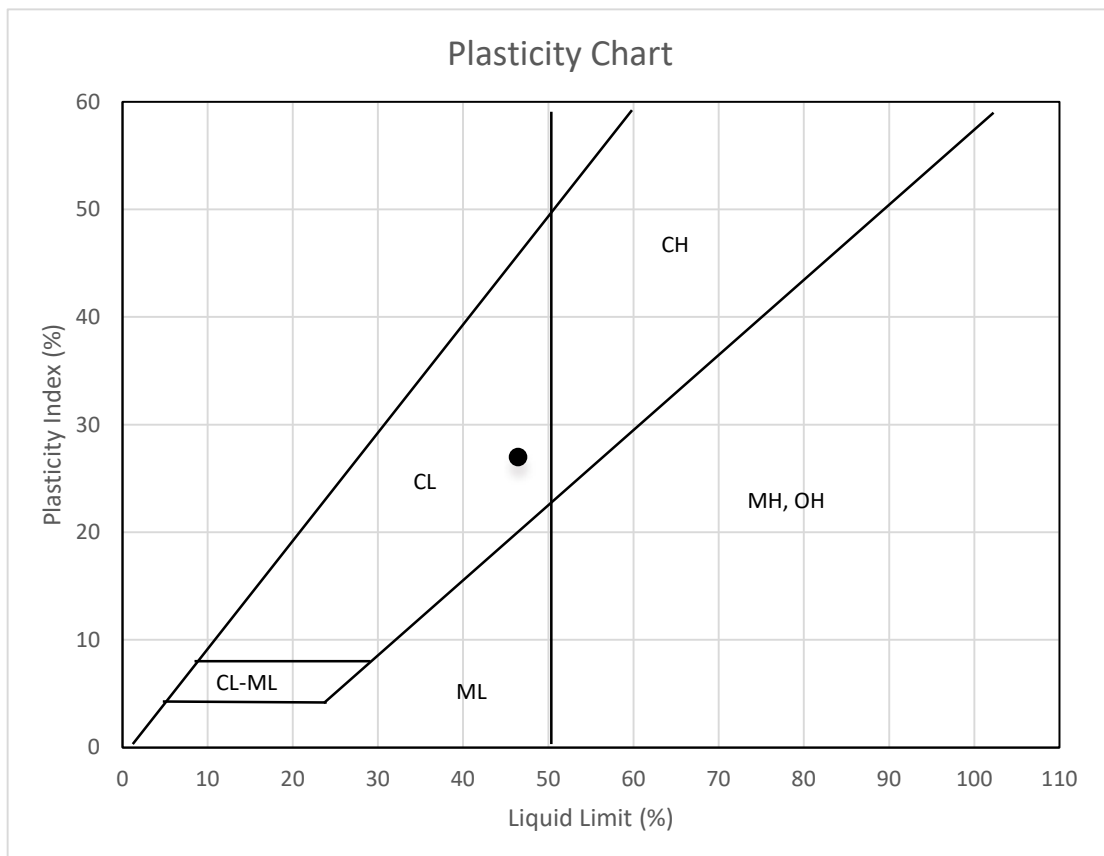

Liquid Limit	46%
Plastic Limit	20%
Plasticity Index	27%

**Comments:** Silty-Clay, grey.

**Reported By:** D. Cuellar, Technician

**Date:** January 13.2025

**Reviewed By:** R. Serluca, Lab Manager

**Date:** February 5. 2025

Notice: The test data given herein pertain to the sample provide, and may not be applicable to other production zones/periods. This report constitutes a testing service only. Interpretation of the data given here may be provided upon request.

Suite 300, 4342 Queen St, Niagara Falls, Ontario, Canada, L2E 7J7 Tel:1 (905) 374 5200 www.hatch.com.

©Hatch 2017 All rights reserved, including all rights relating to the use of this document and its contents.

# Liquid Limit, Plastic Limit and Plasticity Index of Soils.



## ASTM D4318-17 Method A

Date: January 13.2025

Project Number: H375142

Project: South March BESS

Brookfield BRP

Brookfield Place, Suite 100, 181 Bay St. Toronto

ON. M5J 2T3

Attn: Ted Beadle

<b>Sample</b>	SS2	<b>Depth</b>	2ft - 4ft
<b>Source</b>	FY24-3		

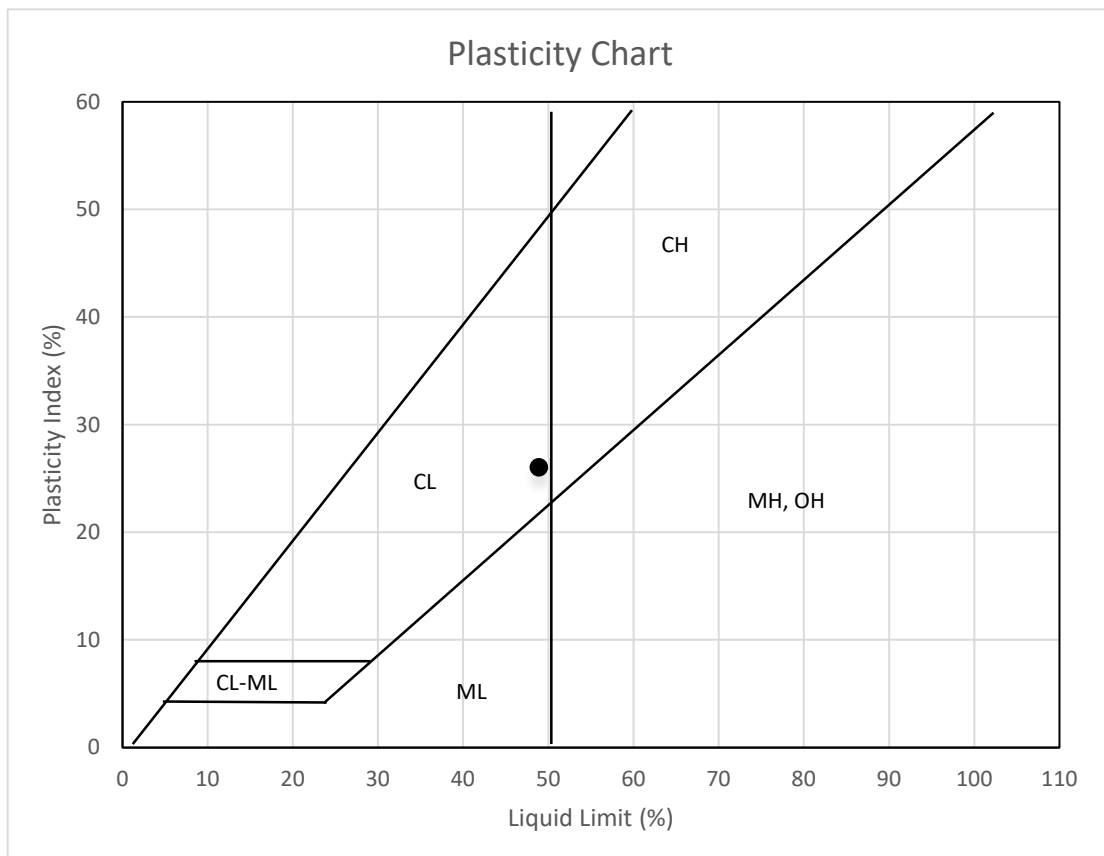

Liquid Limit	49%
Plastic Limit	23%
Plasticity Index	26%

**Comments:** Silty-Clay, grey.

**Reported By:** D. Cuellar, Technician

**Date:** January 13.2025

**Reviewed By:** R. Serluca, Lab Manager

**Date:** February 5. 2025

Notice: The test data given herein pertain to the sample provide, and may not be applicable to other production zones/periods. This report constitutes a testing service only. Interpretation of the data given here may be provided upon request.

Suite 300, 4342 Queen St, Niagara Falls, Ontario, Canada, L2E 7J7 Tel:1 (905) 374 5200 [www.hatch.com](http://www.hatch.com).

©Hatch 2017 All rights reserved, including all rights relating to the use of this document and its contents.

# Liquid Limit, Plastic Limit and Plasticity Index of Soils.



## ASTM D4318-17 Method A

Date: January 13.2025

Project Number: H375142

Project: South March BESS

Brookfield BRP

Brookfield Place, Suite 100, 181 Bay St. Toronto

ON. M5J 2T3

Attn: Ted Beadle

<b>Sample</b>	SS4	<b>Depth</b>	6ft - 8ft
<b>Source</b>	FY24-5		

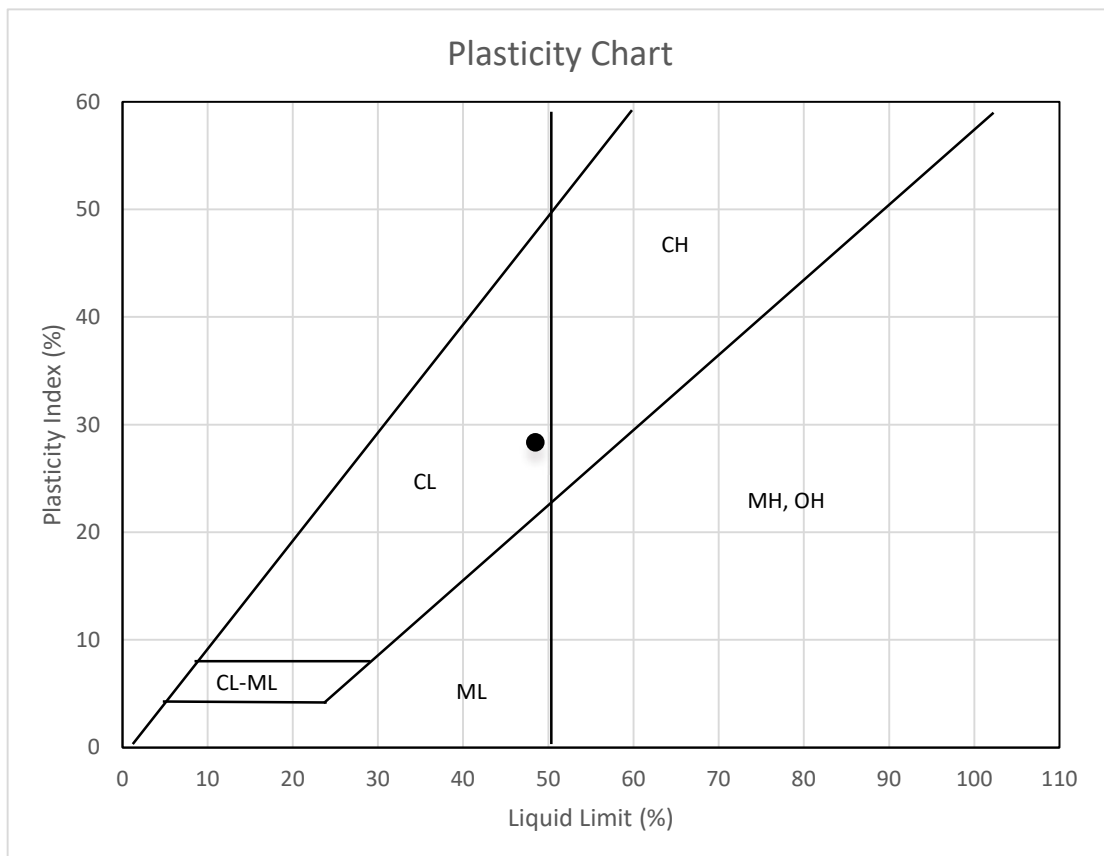

Liquid Limit	48%
Plastic Limit	20%
Plasticity Index	28%

**Comments:** Silty-Clay, grey.

**Reported By:** D. Cuellar, Technician

**Date:** January 13.2025

**Reviewed By:** R. Serluca, Lab Manager

**Date:** February 5. 2025

Notice: The test data given herein pertain to the sample provide, and may not be applicable to other production zones/periods. This report constitutes a testing service only. Interpretation of the data given here may be provided upon request.

Suite 300, 4342 Queen St, Niagara Falls, Ontario, Canada, L2E 7J7 Tel:1 (905) 374 5200 [www.hatch.com](http://www.hatch.com).

©Hatch 2017 All rights reserved, including all rights relating to the use of this document and its contents.

# Liquid Limit, Plastic Limit and Plasticity Index of Soils.



## ASTM D4318-17 Method A

Date: January 13.2025

Project Number: H375142

Project: South March BESS

Brookfield BRP

Brookfield Place, Suite 100, 181 Bay St. Toronto

ON. M5J 2T3

Attn: Ted Beadle

<b>Sample</b>	SS10	<b>Depth</b>	18ft - 20ft
<b>Source</b>	FY24-5		

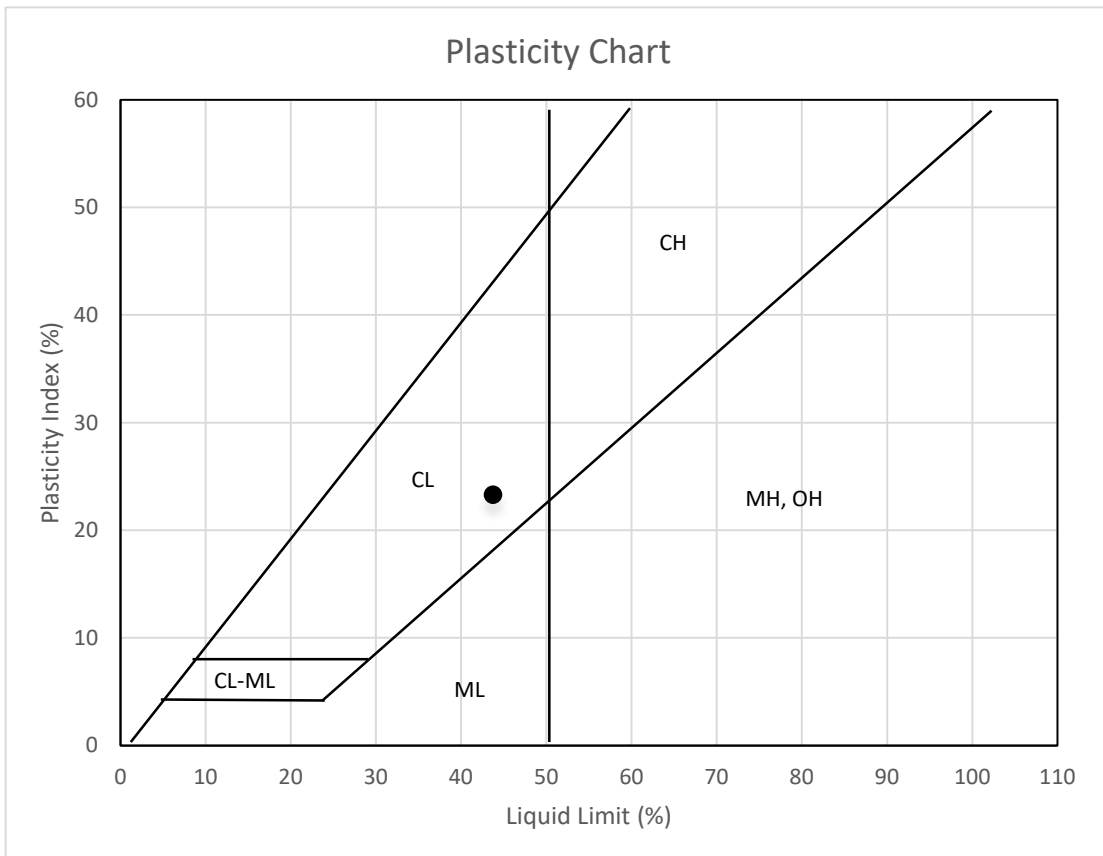

Liquid Limit	44%
Plastic Limit	20%
Plasticity Index	23%

**Comments:** Silty-Clay, grey.

**Reported By:** D. Cuellar, Technician

**Date:** January 13.2025

**Reviewed By:** R. Serluca, Lab Manager

**Date:** February 5. 2025

Notice: The test data given herein pertain to the sample provide, and may not be applicable to other production zones/periods. This report constitutes a testing service only. Interpretation of the data given here may be provided upon request.

Suite 300, 4342 Queen St, Niagara Falls, Ontario, Canada, L2E 7J7 Tel:1 (905) 374 5200 [www.hatch.com](http://www.hatch.com).

©Hatch 2017 All rights reserved, including all rights relating to the use of this document and its contents.

# Liquid Limit, Plastic Limit and Plasticity Index of Soils.



## ASTM D4318-17 Method A

Date: January 13.2025

Project Number: H375142

Project: South March BESS

Brookfield BRP

Brookfield Place, Suite 100, 181 Bay St. Toronto

ON. M5J 2T3

Attn: Ted Beadle

<b>Sample</b>	SS4	<b>Depth</b>	7.5ft - 9.5ft
<b>Source</b>	FY24-7		

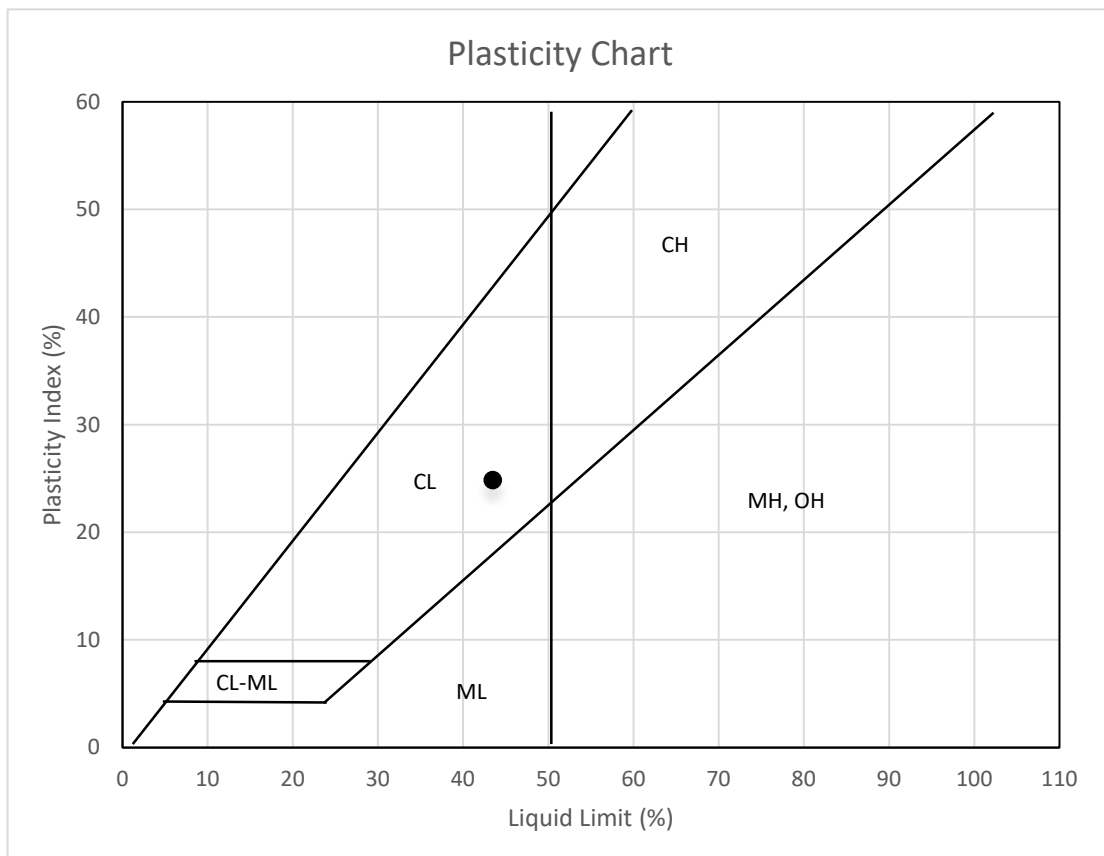

Liquid Limit	43%
Plastic Limit	19%
Plasticity Index	25%

**Comments:** Silty-Clay, grey.

**Reported By:** D. Cuellar, Technician

**Date:** January 13.2025

**Reviewed By:** R. Serluca, Lab Manager

**Date:** February 5. 2025

Notice: The test data given herein pertain to the sample provide, and may not be applicable to other production zones/periods. This report constitutes a testing service only. Interpretation of the data given here may be provided upon request.

Suite 300, 4342 Queen St, Niagara Falls, Ontario, Canada, L2E 7J7 Tel:1 (905) 374 5200 [www.hatch.com](http://www.hatch.com).

©Hatch 2017 All rights reserved, including all rights relating to the use of this document and its contents.

# Liquid Limit, Plastic Limit and Plasticity Index of Soils.



## ASTM D4318-17 Method A

Date: January 13.2025

Project Number: H375142

Project: South March BESS

Brookfield BRP

Brookfield Place, Suite 100, 181 Bay St. Toronto

ON. M5J 2T3

Attn: Ted Beadle

<b>Sample</b>	SS7	<b>Depth</b>	15ft - 17ft
<b>Source</b>	FY24-7		

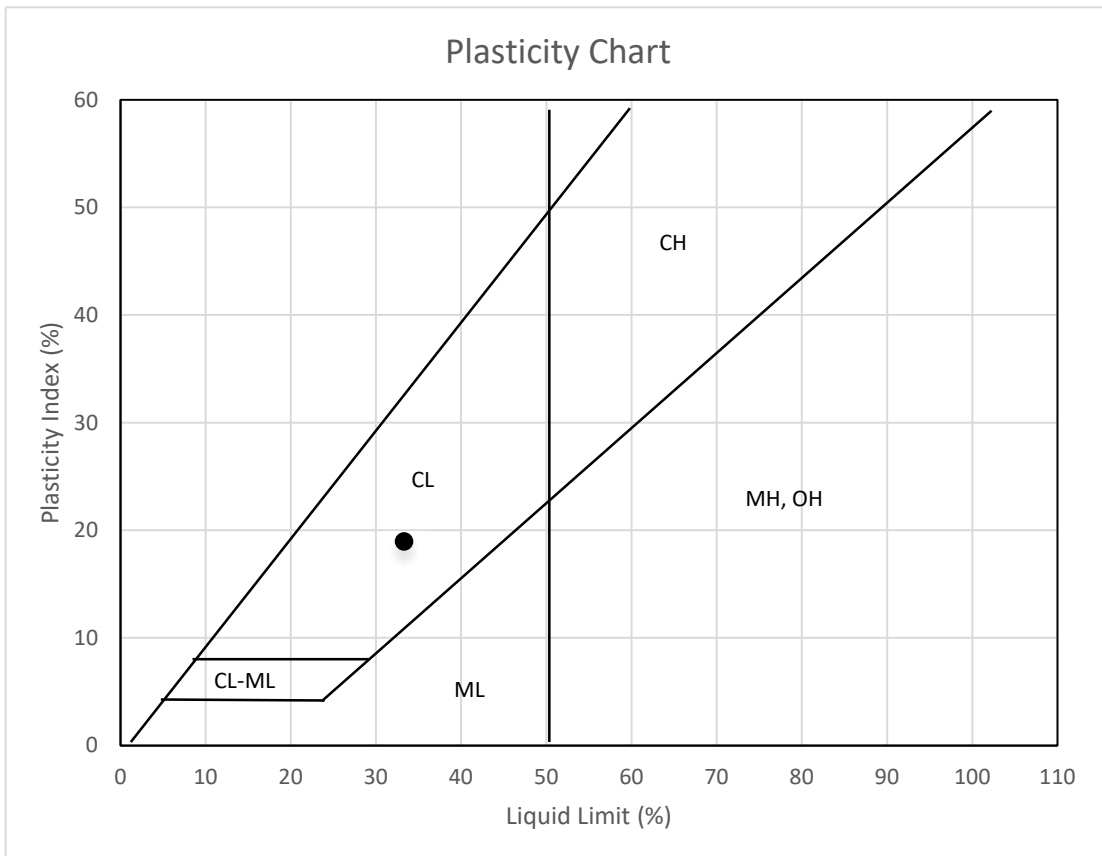

Liquid Limit	33%
Plastic Limit	14%
Plasticity Index	19%

**Comments:** Silty-Clay, grey.

**Reported By:** D. Cuellar, Technician

**Date:** January 13.2025

**Reviewed By:** R. Serluca, Lab Manager

**Date:** February 5. 2025

Notice: The test data given herein pertain to the sample provide, and may not be applicable to other production zones/periods. This report constitutes a testing service only. Interpretation of the data given here may be provided upon request.

Suite 300, 4342 Queen St, Niagara Falls, Ontario, Canada, L2E 7J7 Tel:1 (905) 374 5200 [www.hatch.com](http://www.hatch.com).

©Hatch 2017 All rights reserved, including all rights relating to the use of this document and its contents.

# Grain Size Distribution ASTM D422-16

Job No. : **15599**

Project: H/375142/999-0101  
 Reported To: Hatch

Test Date: 1/7/25  
 Report Date: 1/14/25

	Location / Boring No.	Sample No.	Depth (ft)	Sample Type	Soil Classification
*	FY24-1		1-5	Bulk	Lean Clay (CL)
●					
◇					

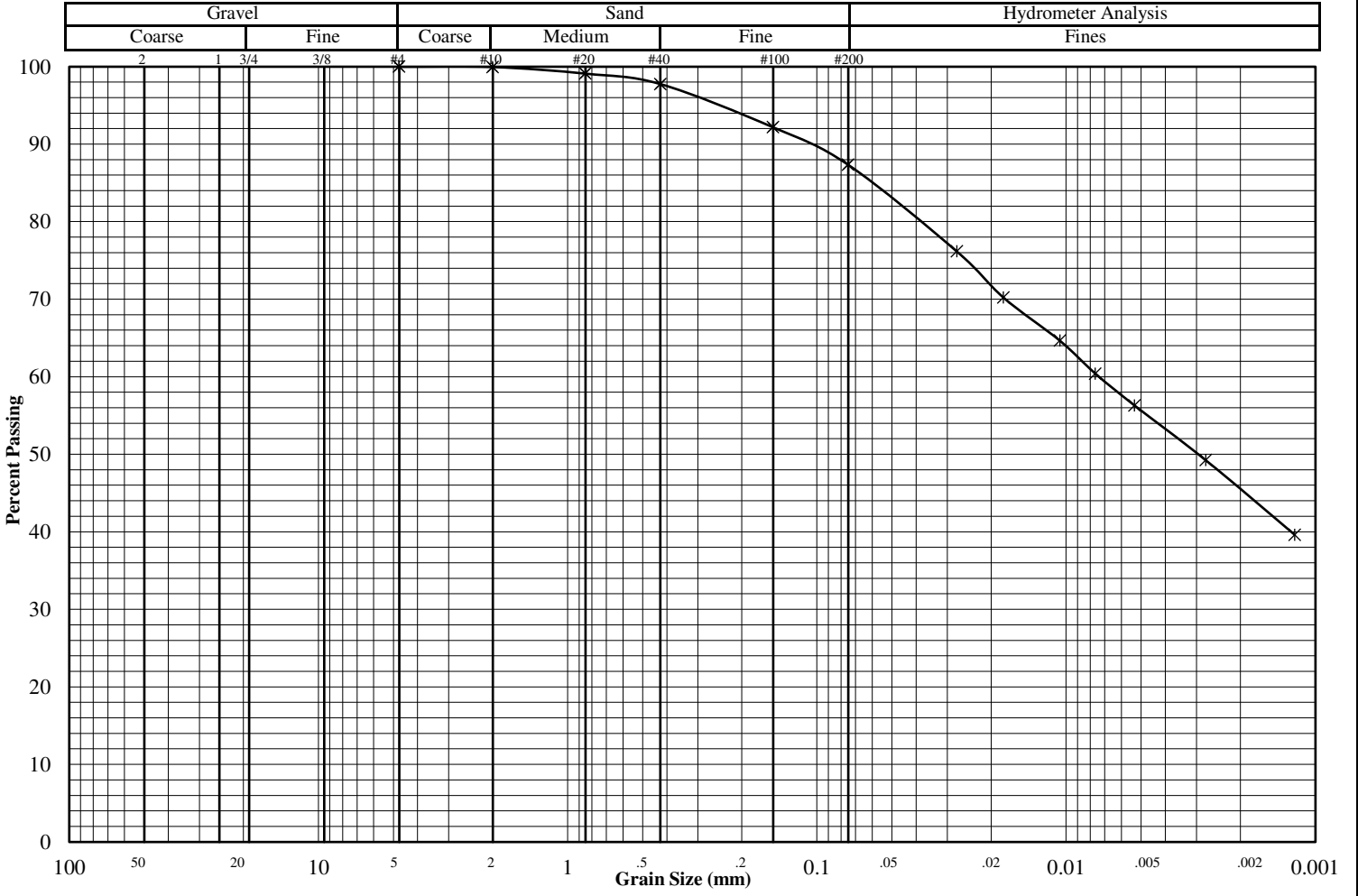

**Additional Results**

Liquid Limit  
 Plastic Limit  
 Plasticity Index  
ASTM: D4318  
 Water Content  
ASTM: D2216  
 Dry Density (pcf)  
ASTM: D7263  
 Specific Gravity  
ASTM: D854  
 Porosity  
 Organic Content  
ASTM: D2974  
 pH  
ASTM: D4972 Method B

	*	●	◇
Liquid Limit	38		
Plastic Limit	18		
Plasticity Index	20		
Water Content			
Dry Density (pcf)			
Specific Gravity	2.71*		
Porosity			
Organic Content			
pH			

Percent Passing

	*	●	◇
Mass (g)	17885.0		
2"			
1.5"			
1"			
3/4"			
3/8"			
#4	100.0		
#10	100.0		
#20	99.1		
#40	97.8		
#100	92.2		
#200	87.3		

	*	●	◇
D <sub>60</sub>			
D <sub>30</sub>			
D <sub>10</sub>			
C <sub>u</sub>			
C <sub>c</sub>			

Remarks:

(\* = assumed)

# Particle Size Distribution (Gradation) of Soils Using Sieve and Hydrometer Analysis



ASTM D6913-17 and D7928-17

Date: August 14, 2025

Brrokfield BRP

Project Number: H376382

Brookfield Place, Suite 100, 181 Bay St. Toronto ON. M5J

Project: South March Bess

2T3

Attn: Ted Beadle

<b>Sample</b>	3	<b>Depth</b>	4ft - 6ft
<b>Source</b>	FY25-1		

Sieve (mm)	% Passing	Sieve (mm)	% Passing	Size (mm)	% Passing
75	100.0	4.75	100.0	0.0339	89.8
63	100.0	2	100.0	0.0247	85.2
53	100.0	0.850	99.9	0.0160	80.6
37.5	100.0	0.425	99.8	0.0096	74.2
26.5	100.0	0.250	99.7	0.0070	70.5
19	100.0	0.106	99.3	0.0051	65.0
13.2	100.0	0.075	98.9	0.0026	57.7
9.5	100.0			0.0011	44.9

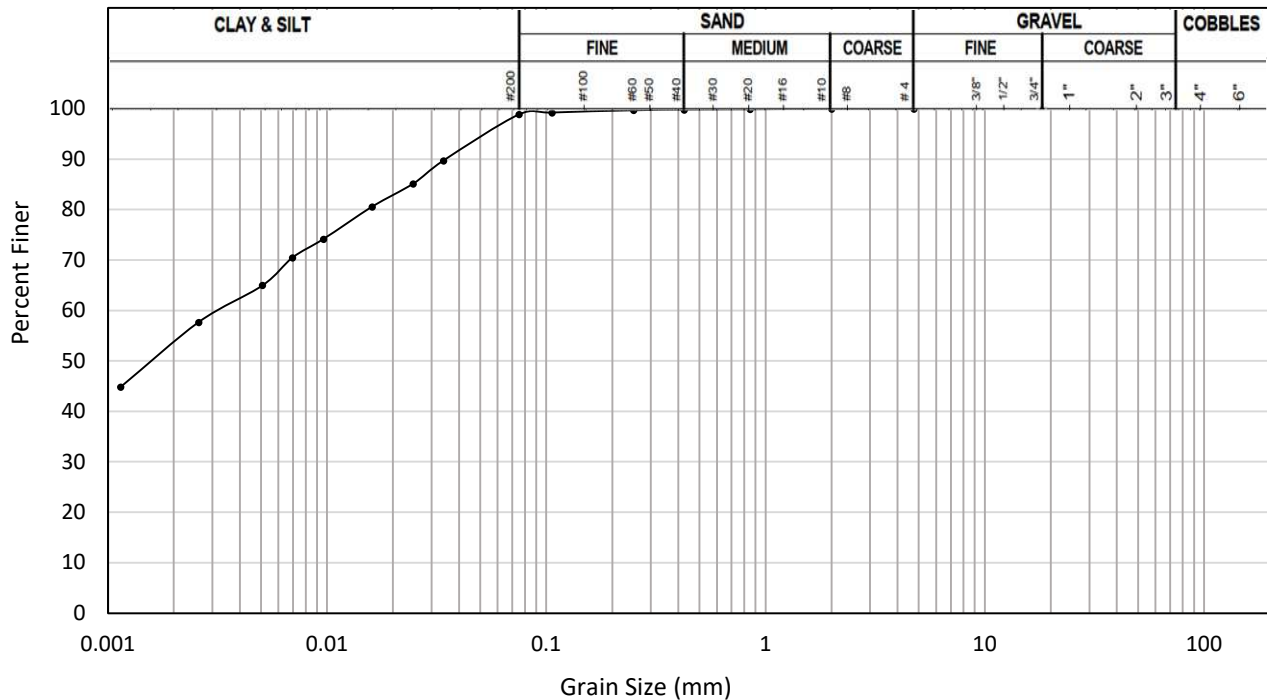

**Comments:** Whole sample, tested as received. 100% passing the 2mm sieve.

**Reported By:** D. Cuellar, Technician

**Date:** August 15, 2025

**Reviewed By:** R. Serluca, Lab Manager

**Date:** August 19, 2025

Notice: The test data given herein pertain to the sample provide, and may not be applicable to other production zones/periods. This report constitutes a testing service only. Interpretation of the data given here may be provided upon request.

Suite 300, 4342 Queen St, Niagara Falls, Ontario, Canada, L2E 7J7 Tel:1 (905) 374 5200 [www.hatch.com](http://www.hatch.com).

©Hatch 2017 All rights reserved, including all rights relating to the use of this document and its contents.

# Liquid Limit, Plastic Limit and Plasticity Index of Soils.



## ASTM D4318-17 Method A

Date: August 15.2025

Project Number: H/376382

Project: South March BESS

Brookfield BRP

Brookfield Place, Suite 100, 181 Bay St. Toronto  
ON. M5J 2T3

Attn: Ted Beadle

<b>Sample</b>	3	<b>Depth</b>	4ft - 6ft
<b>Source</b>	FY25-1		

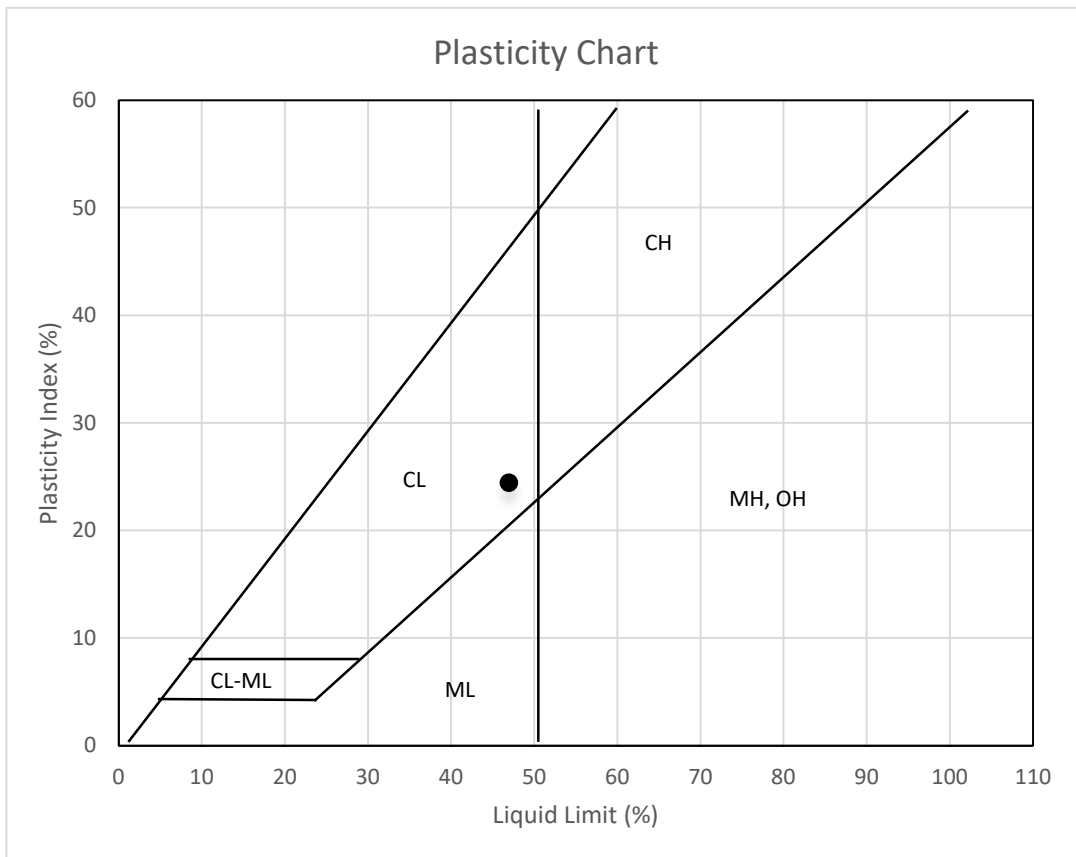

Liquid Limit	47%
Plastic Limit	23%
Plasticity Index	24%

**Comments:** Silty-Clay, grey.

**Reported By:** D. Cuellar, Technician

**Date:** August 15.2025

**Reviewed By:** R. Serluca, Lab Manager

**Date:** August 18.2025

Notice: The test data given herein pertain to the sample provide, and may not be applicable to other production zones/periods. This report constitutes a testing service only. Interpretation of the data given here may be provided upon request.

Suite 300, 4342 Queen St, Niagara Falls, Ontario, Canada, L2E 7J7 Tel:1 (905) 374 5200 www.hatch.com.

©Hatch 2017 All rights reserved, including all rights relating to the use of this document and its contents.

# Liquid Limit, Plastic Limit and Plasticity Index of Soils.



## ASTM D4318-17 Method A

Date: August 15.2025

Project Number: H/376382

Project: South March BESS

Brookfield BRP

Brookfield Place, Suite 100, 181 Bay St. Toronto  
ON. M5J 2T3

Attn: Ted Beadle

<b>Sample</b>	7	<b>Depth</b>	12.5ft - 14.5ft
<b>Source</b>	FY25-1		

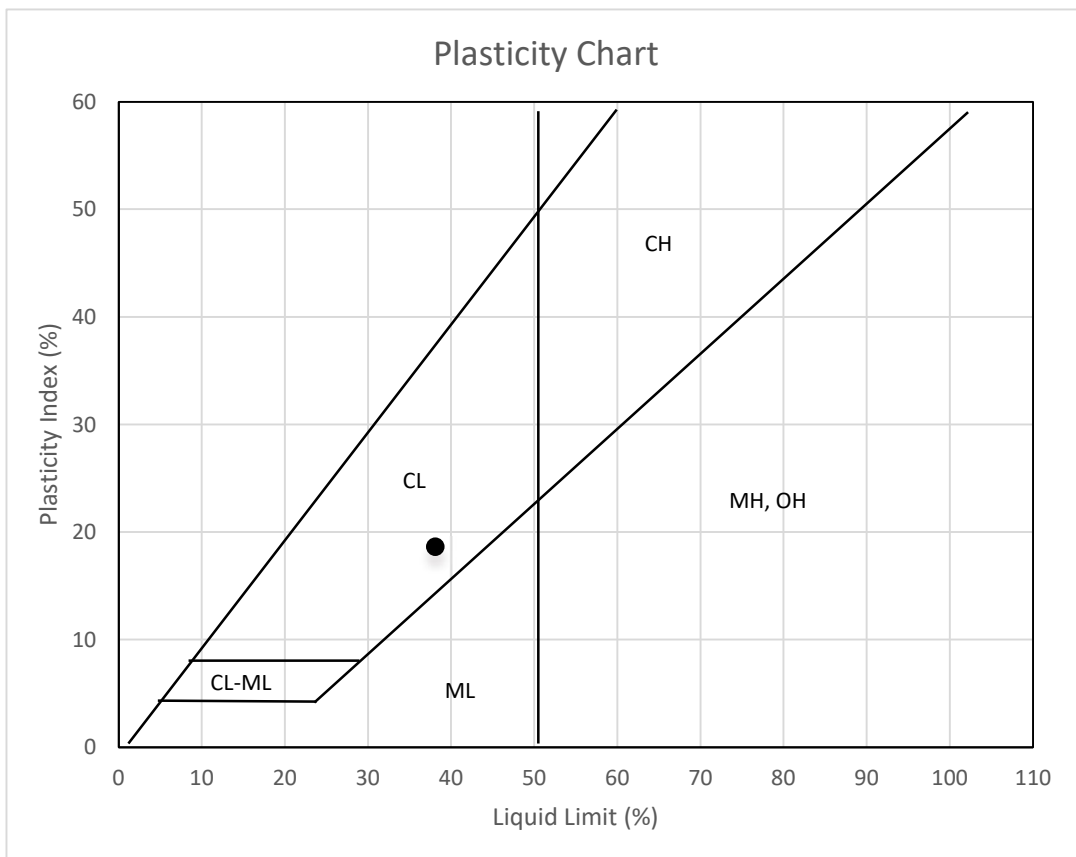

Liquid Limit	38%
Plastic Limit	19%
Plasticity Index	19%

**Comments:** Silty-Clay, grey.

<b>Reported By:</b>	D. Cuellar, Technician	<b>Date:</b>	August 15.2025
<b>Reviewed By:</b>	R. Serluca, Lab Manager	<b>Date:</b>	August 18.2025

Notice: The test data given herein pertain to the sample provide, and may not be applicable to other production zones/periods. This report constitutes a testing service only. Interpretation of the data given here may be provided upon request.

Suite 300, 4342 Queen St, Niagara Falls, Ontario, Canada, L2E 7J7 Tel:1 (905) 374 5200 www.hatch.com.

©Hatch 2017 All rights reserved, including all rights relating to the use of this document and its contents.

# Liquid Limit, Plastic Limit and Plasticity Index of Soils.



## ASTM D4318-17 Method A

Date: August 25.2025

Project Number: H/376382

Project: South March BESS

Brookfield BRP

Brookfield Place, Suite 100, 181 Bay St. Toronto

ON. M5J 2T3

Attn: Ted Beadle

<b>Sample</b>	3	<b>Depth</b>	4ft - 6ft
<b>Source</b>	FY25-2		

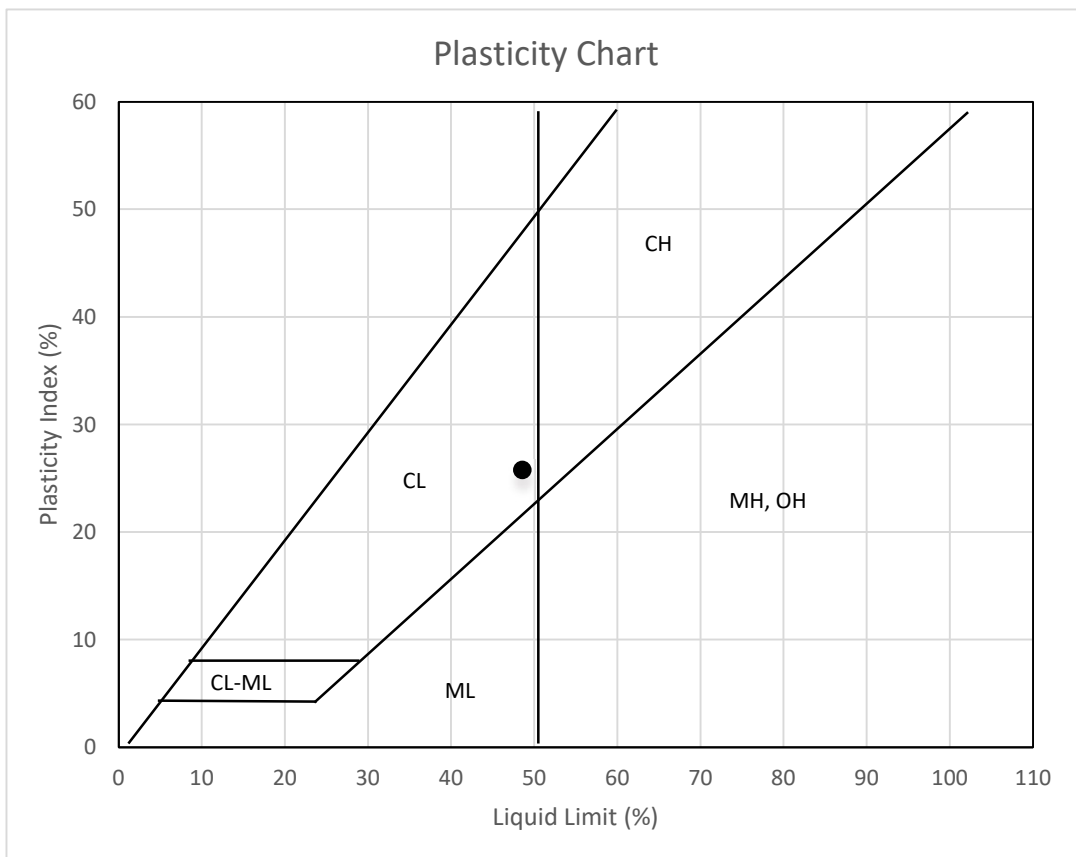

Liquid Limit	49%
Plastic Limit	23%
Plasticity Index	26%

**Comments:** Silty-Clay, grey.

<b>Reported By:</b>	D. Cuellar, Technician	<b>Date:</b>	August 23.2025
<b>Reviewed By:</b>	R. Serluca, Lab Manager	<b>Date:</b>	August 25.2025

Notice: The test data given herein pertain to the sample provide, and may not be applicable to other production zones/periods. This report constitutes a testing service only. Interpretation of the data given here may be provided upon request.

Suite 300, 4342 Queen St, Niagara Falls, Ontario, Canada, L2E 7J7 Tel:1 (905) 374 5200 www.hatch.com.

©Hatch 2017 All rights reserved, including all rights relating to the use of this document and its contents.

# Liquid Limit, Plastic Limit and Plasticity Index of Soils.



## ASTM D4318-17 Method A

Date: August 25.2025

Project Number: H/376382

Project: South March BESS

Brookfield BRP

Brookfield Place, Suite 100, 181 Bay St. Toronto

ON. M5J 2T3

Attn: Ted Beadle

<b>Sample</b>	3	<b>Depth</b>	4ft - 6ft
<b>Source</b>	FY25-3		

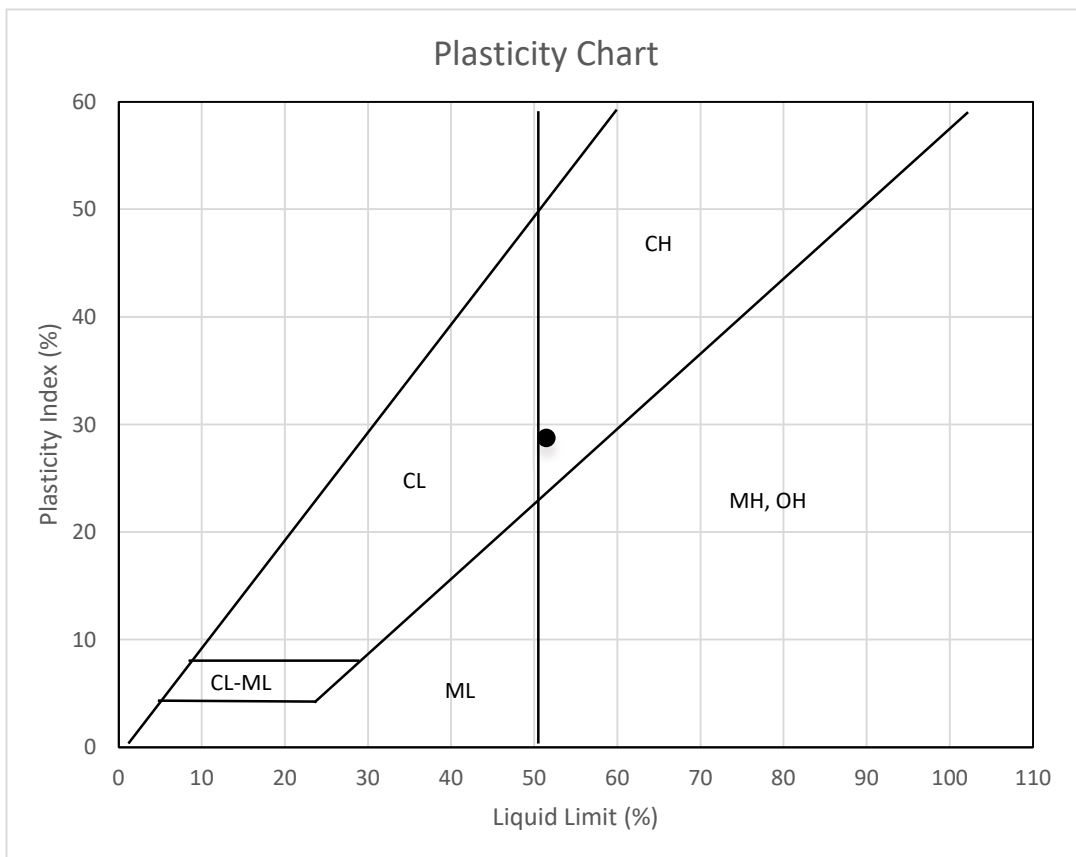

Liquid Limit	51%
Plastic Limit	23%
Plasticity Index	29%

**Comments:** Silty-Clay, grey.

<b>Reported By:</b>	D. Cuellar, Technician	<b>Date:</b>	August 23.2025
<b>Reviewed By:</b>	R. Serluca, Lab Manager	<b>Date:</b>	August 25.2025

Notice: The test data given herein pertain to the sample provide, and may not be applicable to other production zones/periods. This report constitutes a testing service only. Interpretation of the data given here may be provided upon request.

Suite 300, 4342 Queen St, Niagara Falls, Ontario, Canada, L2E 7J7 Tel:1 (905) 374 5200 www.hatch.com.

©Hatch 2017 All rights reserved, including all rights relating to the use of this document and its contents.

# Appendix C

## Advanced Geotechnical Laboratory Testing

# Unconsolidated Undrained Triaxial Compression

## Test on Cohesive Soils

### ASTM D2850-15



Date: January 17, 2025  
 Project Number: H/375142  
 Project: South March BESS

**Brookfield Renewable Power**  
 181 Bay St. Suite 300, Toronto, ON M5J 2T3  
 Attn: Ted Beadle

<b>Sample</b>	4.57 m to 5.17 m
<b>Source</b>	FY24-01

<b>Soil Type:</b> Silty-clay, trace sand and fine gravel, grey, moist.					
Specimen Average Height	7.797	cm	Specific Gravity	2.72	Assumed
Specimen Average Diameter	3.803	cm <sup>2</sup>	Liquid Limit	39	%
Initial Cross Sect. Area	11.298	cm <sup>2</sup>	Plastic Limit	18	%
Moist Specimen Mass	165.25	grams	Plasticity Index	21	%
Moist Density	1876.0	kg/m <sup>3</sup>	E <sup>m</sup> of Membrane	1200	kPa
Moisture Content	35.5	%			
Dry Density	1341.5	kg/m <sup>3</sup>	Confining Pressure - $\delta_3$	100	kPa
L/D Ratio	2.06		Strain Rate	0.20	% /min

<b>Axial Strain at Peak</b>	15 %	<b>Max. Deviator Stress (<math>\delta^1 - \delta^3</math>)</b>	105.83 kPa
-----------------------------	------	--	------------

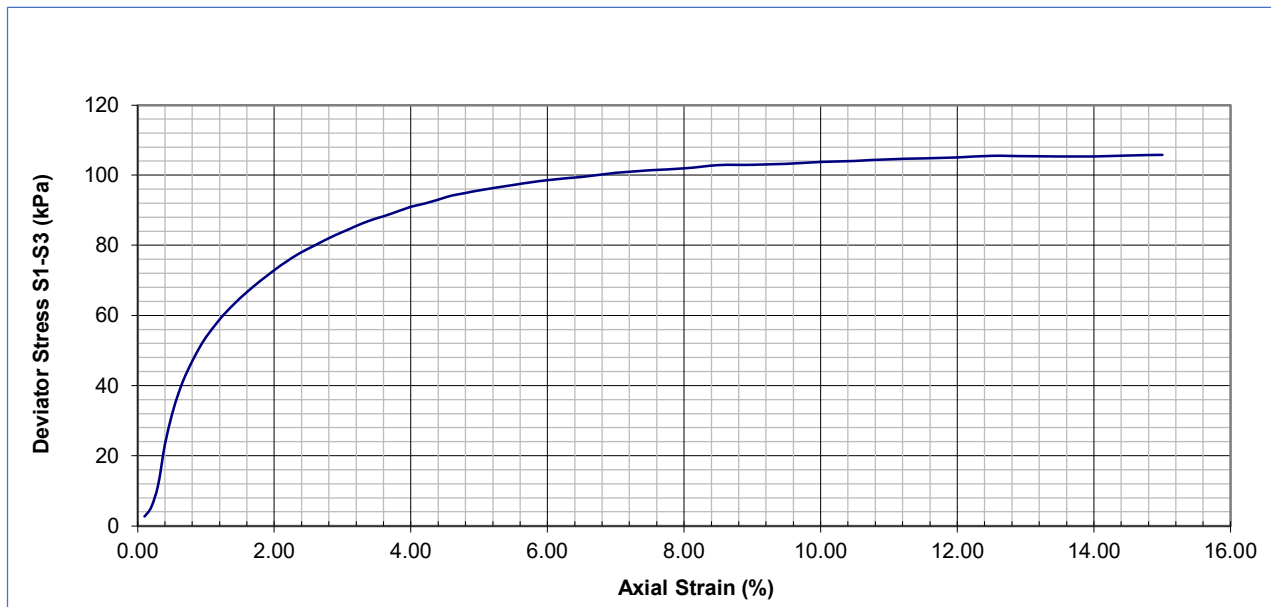

**Reported By:** R. Serluca . Lab Manager  
**Reviewed By:** A. Touhidi

**Date:** January 22, 2025  
**Date:** February 18, 2025

Notice: The test data given herein pertain to the sample provide, and may not be applicable to other production zones/periods. This report constitutes a testing service only. Interpretation of the data given here may be provided upon request.

Suite 300, 4342 Queen St, Niagara Falls, Ontario, Canada, L2E 7J7 Tel:1 (905) 374 5200 www.hatch.com.

©Hatch 2017 All rights reserved, including all rights relating to the use of this document and its contents.

**Unconsolidated Undrained Triaxial Compression  
Test on Cohesive Soils  
ASTM D2850-15**



Date: January 17, 2025  
Project Number: H/375142  
Project: South March BESS

**Brookfield Renewable Power**  
181 Bay St. Suite 300, Toronto, ON M5J 2T3  
Attn: Ted Beadle

<b>Sample</b>	4.57 m to 5.17 m
<b>Source</b>	FY24-01

Photo Not Available

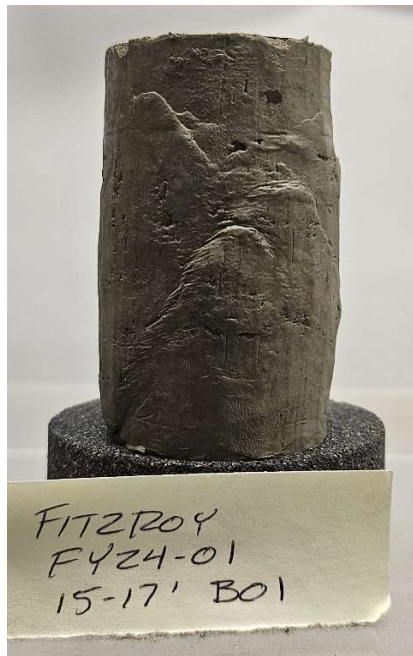

**BEFORE**

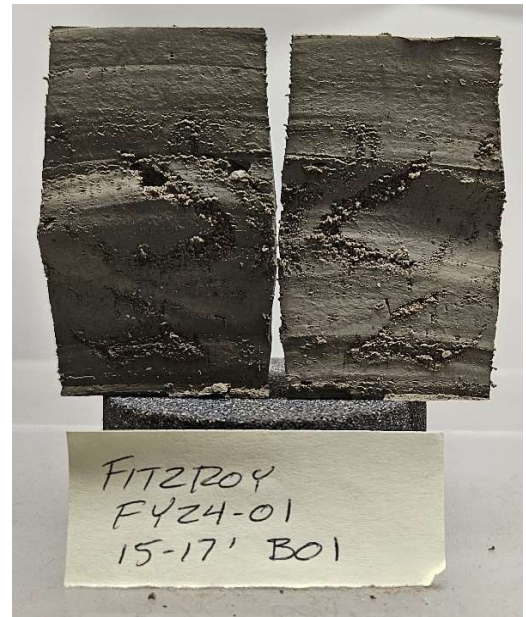

**AFTER**

**AFTER**

**NOTES:**

Strain rate slightly less than minimum suggested by ASTM was chosen to facilitate manual readings.

# Unconsolidated Undrained Triaxial Compression

## Test on Cohesive Soils

### ASTM D2850-15



Date: February 12.2025  
 Project Number: H/375142  
 Project: South March BESS

**Brookfield Renewable Power**  
 181 Bay St. Suite 300, Toronto, ON M5J 2T3  
 Attn: Ted Beadle

<b>Sample</b>	4.57 m to 5.17 m
<b>Source</b>	FY24-05, Test 2

<b>Soil Type:</b> Silty clay, grey, moist.					
Specimen Average Height	7.810	cm	Specific Gravity	2.72	Assumed
Specimen Average Diameter	3.795	cm <sup>2</sup>	Liquid Limit	37	%
Initial Cross Sect. Area	11.313	cm <sup>2</sup>	Plastic Limit	18	%
Moist Specimen Mass	153.98	grams	Plasticity Index	19	%
Moist Density	1742.7	kg/m <sup>3</sup>	E <sup>m</sup> of Membrane	1200	kPa
Moisture Content	48.3	%			
Dry Density	1173.2	kg/m <sup>3</sup>	Confining Pressure - $\delta_3$	100	kPa
L/D ratio	2.06		Strain Rate	0.29	% /min

<b>Axial Strain at Peak</b>	3 %	<b>Max. Deviator Stress (<math>\delta^1 - \delta^3</math>)</b>	68.00 kPa
-----------------------------	-----	--	-----------

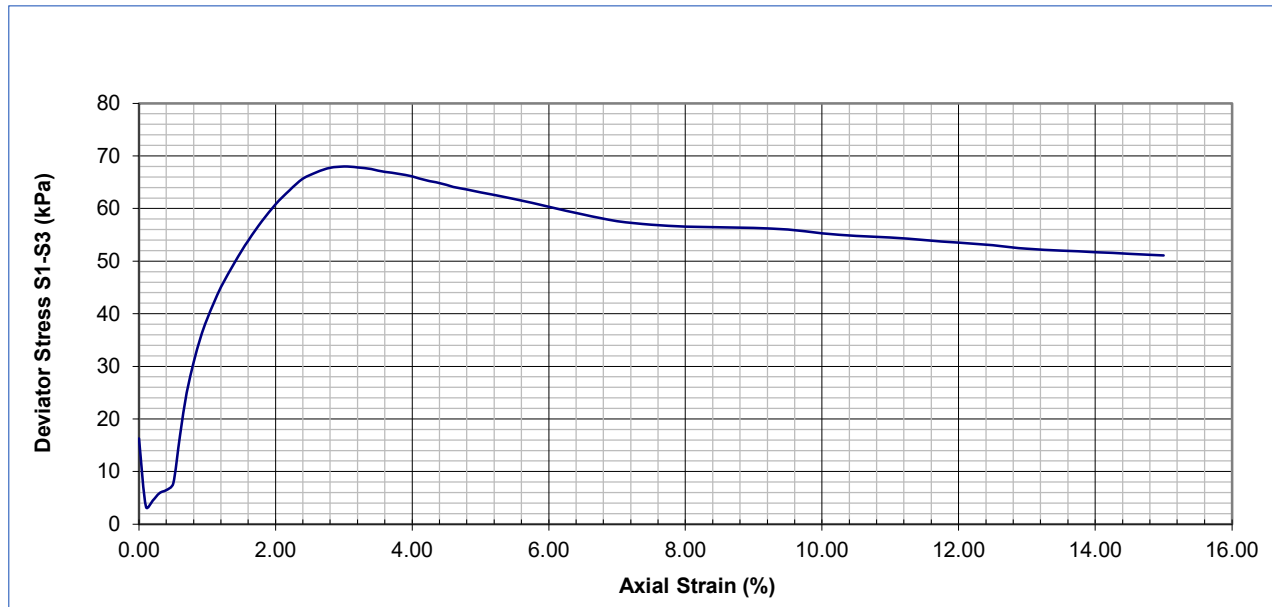

**Reported By:** R. Serluca . Lab Manager  
**Reviewed By:** A. Touhidi

**Date:** January 22.2025  
**Date:** February 18.2025

Notice: The test data given herein pertain to the sample provide, and may not be applicable to other production zones/periods. This report constitutes a testing service only. Interpretation of the data given here may be provided upon request.

Suite 300, 4342 Queen St, Niagara Falls, Ontario, Canada, L2E 7J7 Tel:1 (905) 374 5200 www.hatch.com.

©Hatch 2017 All rights reserved, including all rights relating to the use of this document and its contents.

**Unconsolidated Undrained Triaxial Compression  
Test on Cohesive Soils  
ASTM D2850-15**



Date: February 12.2025  
Project Number: H/375142  
Project: South March BESS

**Brookfield Renewable Power**  
181 Bay St. Suite 300, Toronto, ON M5J 2T3  
Attn: Ted Beadle

Sample	4.57 m to 5.17 m
Source	FY24-05, Test 2

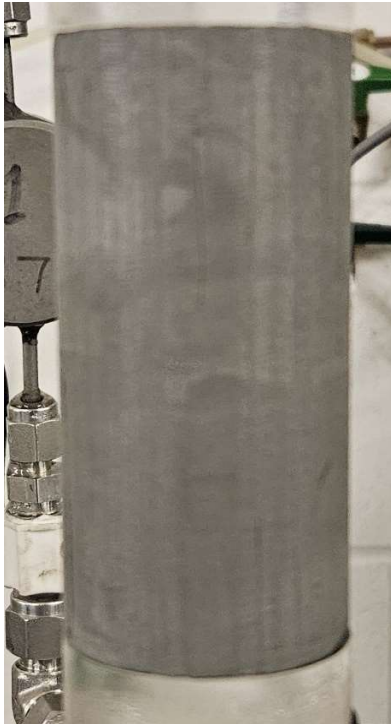

**BEFORE**



**AFTER**

**NOTES:**

Strain rate slightly less than minimum suggested ASTM was chosen to facilitate manual readings.

# Unconfined Compressive Strength of Cohesive Soils

ASTM D2166-24



Date: January 20, 2025  
 Project Number: H/375142  
 Project: South March BESS

**Brookfield Renewable Power**  
 181 Bay St. Suite 300, Toronto, ON M5J 2T3  
 Attn: Ted Beadle

<b>Sample</b>	4.57 m to 5.17 m
<b>Source</b>	FY24-05

<b>Soil Type:</b> Silty clay, grey, moist.					
Specimen Average Height	13.322	cm	Specific Gravity	2.72	Assumed
Specimen Average Diameter	5.888	cm	Liquid Limit	37	%
Initial Cross Sect. Area	27.226	cm <sup>2</sup>	Plastic Limit	18	%
Moist Specimen Mass	636.03	grams	Plasticity Index	19	%
Moist Density	1753.6	kg/m <sup>3</sup>			
Moisture Content	50.9	%			
Dry Density	1161.8	kg/m <sup>3</sup>			
L/D Ratio	2.26		Strain Rate	0.38	% /min

<b>Axial Strain at Peak</b>	3.2 %	<b>Max. Stress at Peak ( <math>\delta^1</math> )</b>	182.39 kPa
-----------------------------	-------	--	------------

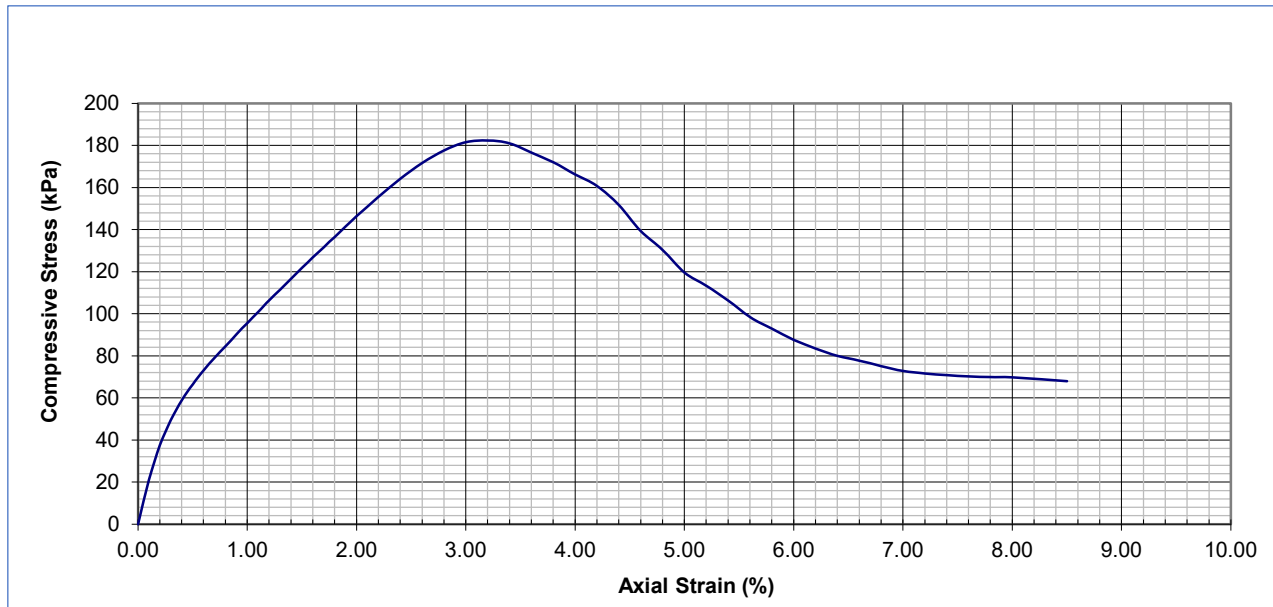

**Reported By:** R. Serluca . Lab Manager **Date:** January 22,2025  
**Reviewed By:** A. Touhidi **Date:** February 18,2025

Notice: The test data given herein pertain to the sample provide, and may not be applicable to other production zones/periods. This report constitutes a testing service only. Interpretation of the data given here may be provided upon request.

Suite 300, 4342 Queen St, Niagara Falls, Ontario, Canada, L2E 7J7 Tel:1 (905) 374 5200 www.hatch.com.

©Hatch 2017 All rights reserved, including all rights relating to the use of this document and its contents.

**Unconsolidated Undrained Triaxial Compression  
Test on Cohesive Soils  
ASTM D2850-15**



Date: January 20, 2025  
Project Number: H/375142  
Project: South March BESS

**Brookfield Renewable Power**  
181 Bay St. Suite 300, Toronto, ON M5J 2T3  
Attn: Ted Beadle

Sample	4.57 m to 5.17 m
Source	FY24-05



**BEFORE**



**AFTER**

**NOTES:**

Strain rate slightly slower than ASTM minimum recommended in order to facilitate manual readings.

# One-Dimensional Consolidation of Soils Using Incremental Loading.

ASTM D 2435-11



Date: February 10.2025  
 Project Number: H/375142  
 Project: South March BESS

Brookfield Renewable Power  
 Brookfield Place, Suite 100, 181 Bay St. Toronto  
 Attn: Ted Beadle

<b>Sample</b>	TO1	<b>Depth</b>	15 ft to 17 ft
<b>Source</b>	FY24-05	<b>Method</b>	A - 24 hour Increments

**Soil Type:** Clayey SILT, trace Sand, trace Gravel.

Initial Height of Specimen	1.853	cm	Final Height of Sample	1.389	cm
Initial Void Ratio	1.442	-	Final Void Ratio	0.830	-
Initial Degree of Saturation	100.5	%	Final Degree of Saturation	99.9	%
Initial Wet Density	1.732	g/cm <sup>3</sup>	Final Wet Density	1.972	g/cm <sup>3</sup>
Initial Moist Specimen Mass	101.99	grams	Specific Gravity	2.78	
Initial Dry Density	1.14	g/cm <sup>3</sup>	Specimen Diameter	6.361	cm
Initial Moisture Content	52.1	%	Final Moisture Content	29.8	%

Load Stage	Pressure kPa	Final Void Ratio	Final Height cm	t <sub>50</sub> min.	c <sub>v</sub> cm <sup>2</sup> /s	m <sub>v</sub> 1/kPa	k cm/s
Initial	0.0	1.442	1.853				
1	11.5	1.434	1.847				
2	23.9	1.423	1.839				
3	47.7	1.412	1.831				
4	95.5	1.391	1.814				
5	190.9	1.274	1.726				
6	381.8	0.989	1.510	2.89	4.08E-02	6.99E-04	2.80E-06
7	763.7	0.820	1.381	1.82	2.22E-01	2.33E-04	5.08E-06
8	1527.4	0.702	1.292	1.00	6.20E-01	8.77E-05	5.33E-06
9	763.7	0.699	1.290				
10	190.9	0.719	1.304				
11	47.7	0.744	1.324				
12	11.5	0.769	1.343				

**Reported By:** R.Serluca, Laboratory Manager

**Date:** February 18.2025

**Reviewed By:** T. Beadle

**Date:** February 24.2025

Notice: The test data given herein pertain to the sample provide, and may not be applicable to other production zones/periods. This report constitutes a testing service only. Interpretation of the data given here may be provided upon request.

Suite 300, 4342 Queen St, Niagara Falls, Ontario, Canada, L2E 7J7 Tel:1 (905) 374 5200 www.hatch.com.

©Hatch 2017 All rights reserved, including all rights relating to the use of this document and its contents.

# One-Dimensional Consolidation of Soils Using Incremental Loading.

ASTM D 2435-11

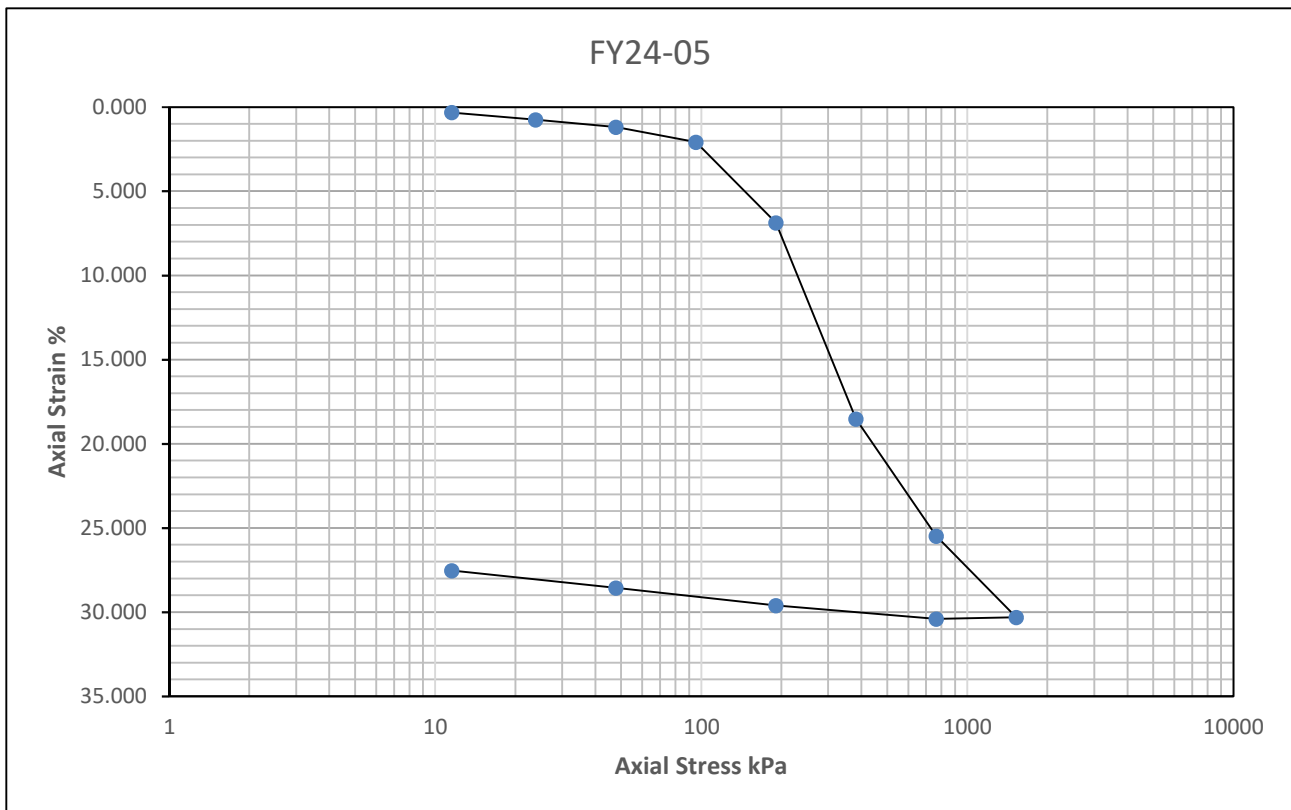
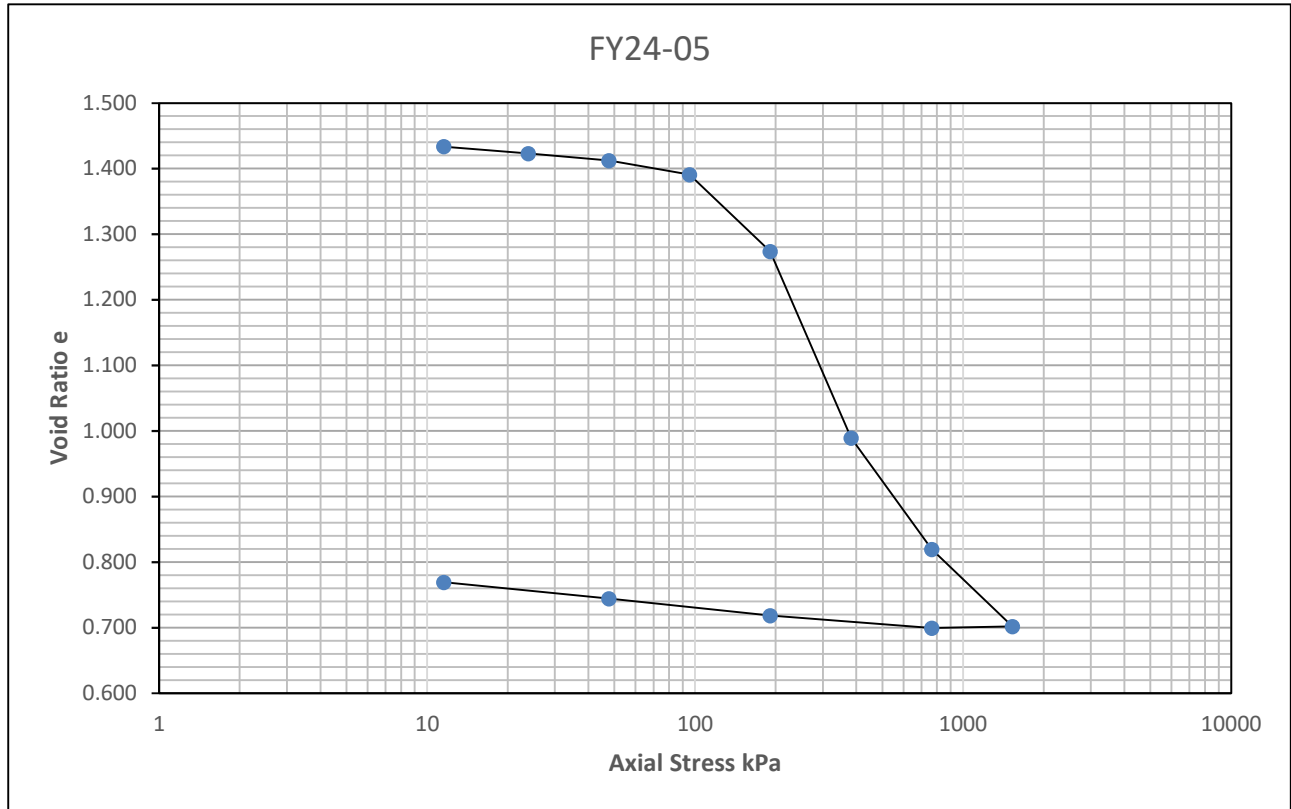

# One-Dimensional Consolidation of Soils Using Incremental Loading.

ASTM D 2435-11



## Test Notes.

- 1- Standard load increment durations were 24 hrs.
- 2- Data interpolated at loads that exceeded 24 hrs, namely loading at 191 kPa and unloading 191 kPa loads.
- 3- Seating load of 3.86 kPa applied before test
- 4- Test specimen was trimmed from 75 mm tube sample.
- 5- Specific gravity was determined from sample trimmings

# Thermal Resistivity Report ASTM D:5334

Project: **H/375142/999-0101**

Job #: **15599**

Client: **Hatch**

Date: **1/22/25**

Boring	Specimen Type	Depth (ft)	Type	Classification	Proctor Values		Initial Conditions			Dry
					Maximum Dry Density (PCF)	Optimum Moisture (%)	Dry Density (PCF)	WC (%)	Thermal Resistivity (°C-cm/W)	Thermal Resistivity (°C-cm/W)
<b>FY24-1</b>	<b>Reconstituted</b>	<b>1-5</b>	<b>Bulk</b>	<b>Lean Clay (CL)</b>	<b>104.0</b>	<b>21.6%</b>	<b>88.6</b>	<b>28.4%</b>	<b>81</b>	<b>194</b>
Specimens reconstituted to approximately 85% of maximum standard proctor density near the greater of the as received or optimum moisture content.										

9530 James Ave South



Bloomington, MN 55431

<http://www.soilengineeringtesting.com>

# Thermal Resistivity Report ASTM D:5334

Project: H/375142/999-0101  
Client: Hatch

Job: 15599  
Date: 1/22/25

Specimen A: 

Boring	Depth (ft)
FY24-1	1-5

## Thermal Dryout Curves (Water Content vs. Resistivity)

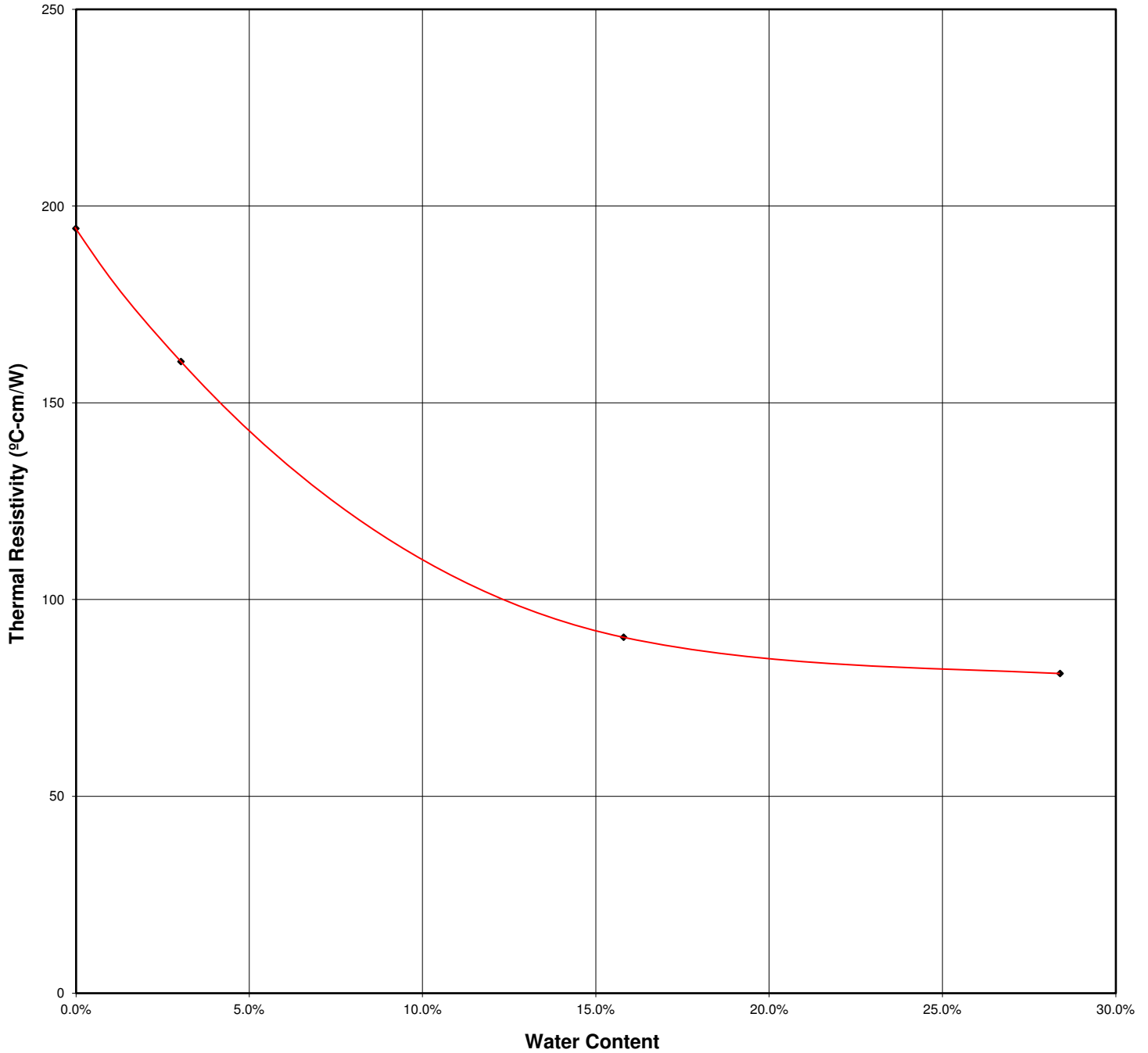

◆ A

# Moisture Density Curve ASTM: D698, Method B

Project: H/375142/999-0101

Date: 1/14/25

Client: Hatch

Job No. 15599

Boring No. FY24-1

Sample:

Depth(ft): 1-5

Location:

Soil Type: Lean Clay (CL)

As Received W.C. (%): 28.6

LL: 38

PL: 18

PI: 20

Specific Gravity: 2.71

\*Assumed

Maximum Dry Density (pcf): 104.0

Opt. Water Content (%): 21.6

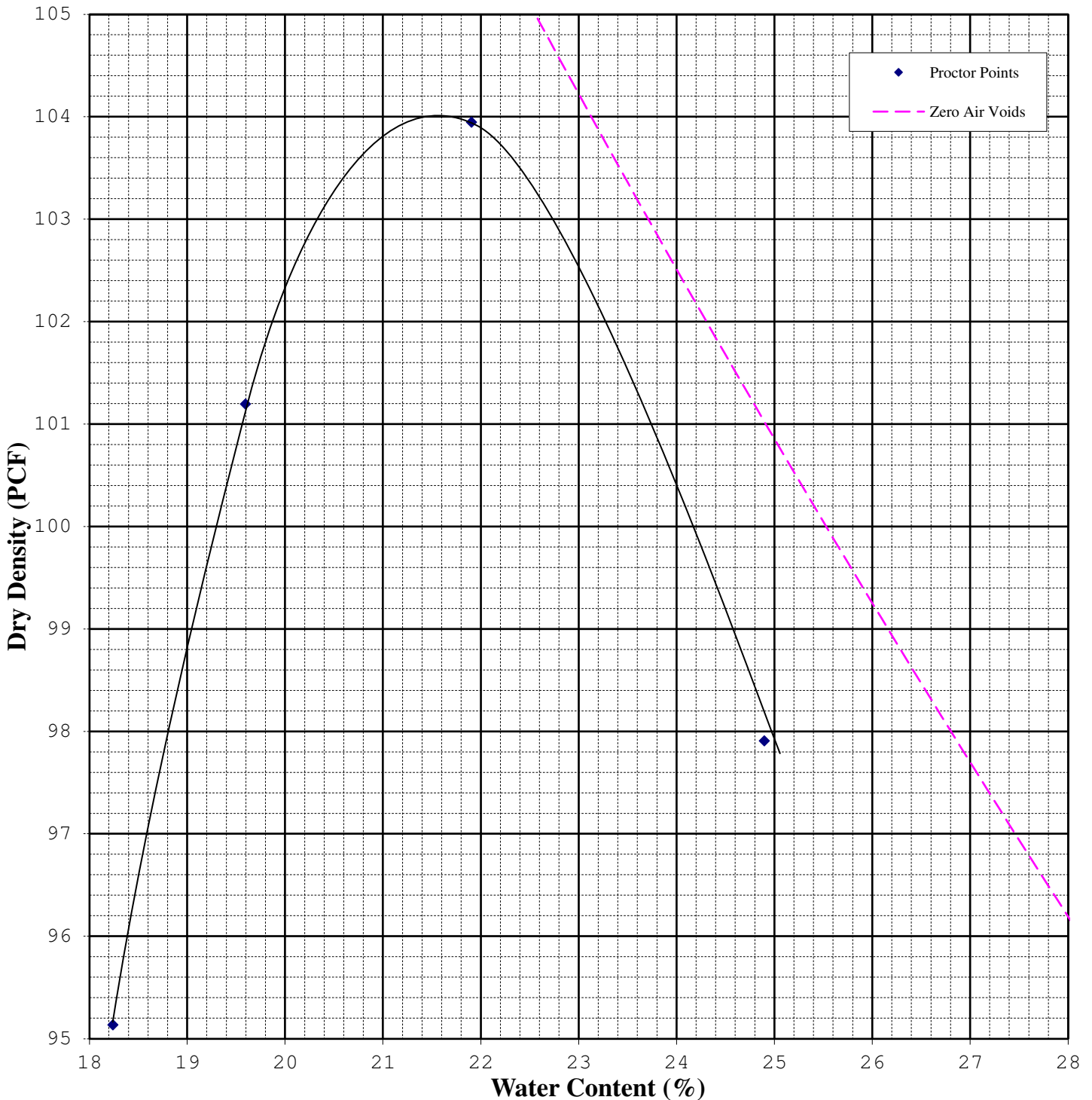

9530 James Ave South



Bloomington, MN 55431

# California Bearing Ratio ASTM:D1883

Project:		H/375142/999-0101		Job:	15599
Client:		Hatch		Date:	1/16/25
Boring #:	FY24-1			Procedural Method:	
Sample:				Specimens compacted to approximately 95% of maximum standard proctor density at optimum moisture content. Specimens soaked for a period of 4 days before CBR test was performed.	
Depth (ft):	1-5				
Type:	Bulk				
Classification:	Lean Clay (CL)				
Laboratory Moisture-Density Values			Index Properties		
Method:		ASTM:D698 Method B		LL:	Gs:
Maximum Dry Density (PCF):	104.0			PL:	Organic Content:
Optimum Water Content:	21.5%			PI:	pH:
Initial Molding Conditions					
Specimen	A				
Compaction Hammer:	5 lb				
Number of Layers:	3				
Blows per Layer:	NA				
Initial Moisture Content:	21.5%				
Initial Dry Density (PCF)	99.0				
Relative Compaction	95.2%				
Soaking Phase					
Days Soaked	4				
Surcharge (psf)	50				
Total Swell (%)	1.8%				
Penetration Phase					
Surcharge (psf)	50				
Corrected CBR Values					
at 0.1 inch (%)	3.1%				
at 0.2 inch (%)	2.8%				
Moisture Content After Penetration					
Top 1" of Specimen:	24.4%				
Average of specimen:	22.9%				

## Stress vs. Penetration Graph

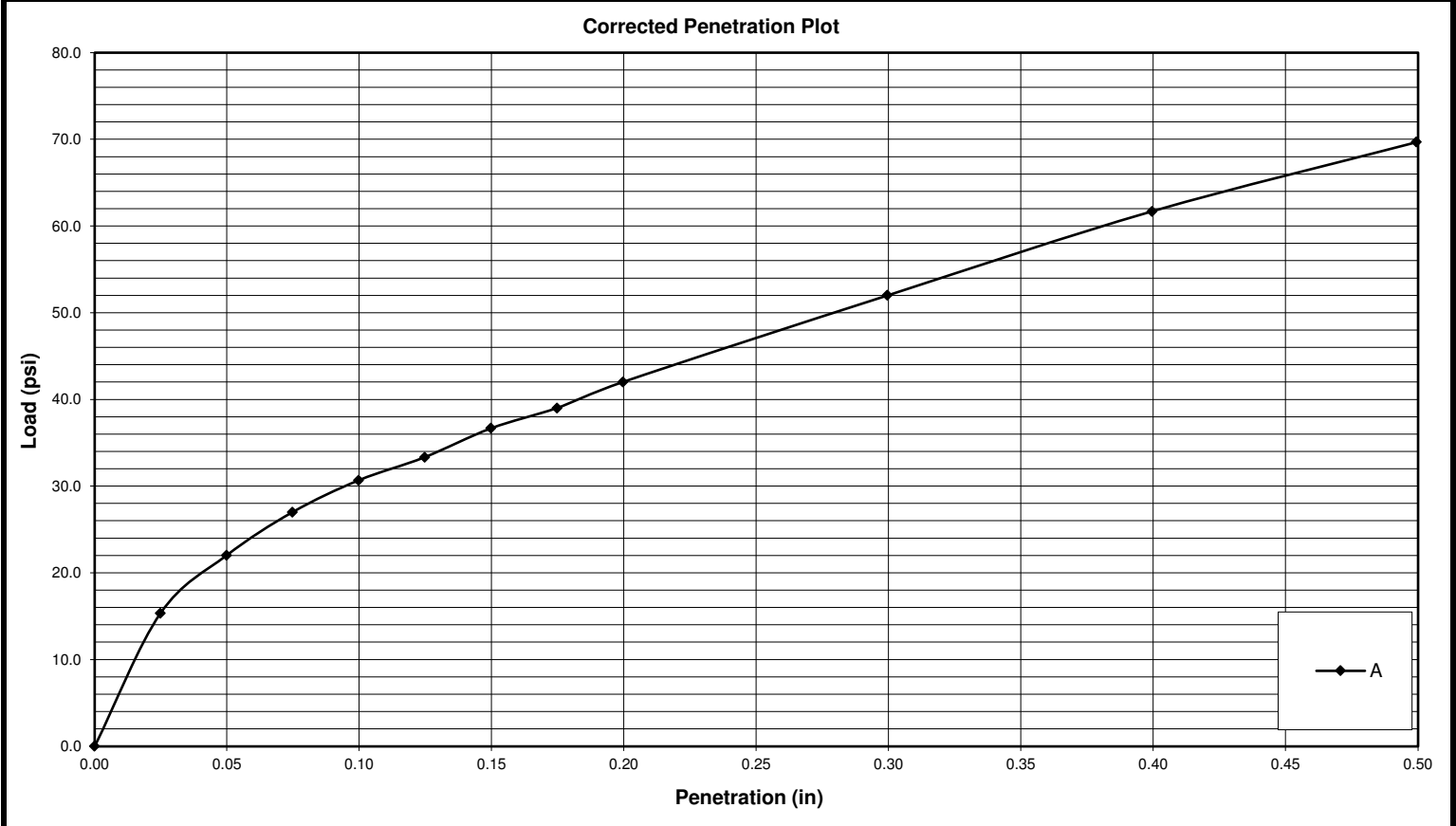

# Appendix D

## Chemical Testing

## Certificate of Analysis

**Hatch Ltd.**

4342 Queen Street, Suite 300

Niagara Falls, ON L2E 7J7

Attn: Ted Beadle

Client PO:

Project: H/375035 / H/375142

Custody: 145330

Report Date: 24-Dec-2024

Order Date: 18-Dec-2024

**Order #: 2451324**

This Certificate of Analysis contains analytical data applicable to the following samples as submitted:

Parcel ID	Client ID
2451324-01	TR24-1-C1
2451324-02	TR24-6-C1
2451324-03	FY24-1-C1
2451324-04	FY24-5-C1

Approved By:



Alex Enfield, MSc

Lab Manager

Certificate of Analysis

Report Date: 24-Dec-2024

Client: Hatch Ltd.

Order Date: 18-Dec-2024

Client PO:

Project Description: H/375035 / H/375142

**Analysis Summary Table**

Analysis	Method Reference/Description	Extraction Date	Analysis Date
Anions	EPA 300.1 - IC, water extraction	23-Dec-24	23-Dec-24
pH, soil	EPA 150.1 - pH probe @ 25 °C, CaCl buffered ext.	19-Dec-24	20-Dec-24
Resistivity	EPA 120.1 - probe, water extraction	23-Dec-24	24-Dec-24
Solids, %	CWS Tier 1 - Gravimetric	19-Dec-24	20-Dec-24

Certificate of Analysis

Report Date: 24-Dec-2024

Client: Hatch Ltd.

Order Date: 18-Dec-2024

Client PO:

Project Description: H/375035 / H/375142

<b>Client ID:</b>	TR24-1-C1	TR24-6-C1	FY24-1-C1	FY24-5-C1	-	-
<b>Sample Date:</b>	18-Dec-24 11:00	18-Dec-24 11:00	18-Dec-24 11:30	18-Dec-24 11:30	-	-
<b>Sample ID:</b>	2451324-01	2451324-02	2451324-03	2451324-04	-	-
<b>Matrix:</b>	Soil	Soil	Soil	Soil	-	-
<b>MDL/Units</b>						

**Physical Characteristics**

% Solids	0.1 % by Wt.	88.3	87.5	73.9	72.3	-	-
----------	--------------	------	------	------	------	---	---

**General Inorganics**

pH	0.05 pH Units	7.36	7.33	7.16	7.10	-	-
Resistivity	0.10 Ohm.m	65.5	102	175	106	-	-

**Anions**

Chloride	5 ug/g	<5	<5	<5	<5	-	-
Sulphate	5 ug/g	72	7	10	6	-	-

Certificate of Analysis

Report Date: 24-Dec-2024

Client: Hatch Ltd.

Order Date: 18-Dec-2024

Client PO:

Project Description: H/375035 / H/375142

**Method Quality Control: Blank**

Analyte	Result	Reporting Limit	Units	%REC	%REC Limit	RPD	RPD Limit	Notes
<b>Anions</b>								
Chloride	ND	5	ug/g					
Sulphate	ND	5	ug/g					
<b>General Inorganics</b>								
Resistivity	ND	0.10	Ohm.m					

Certificate of Analysis

Report Date: 24-Dec-2024

Client: Hatch Ltd.

Order Date: 18-Dec-2024

Client PO:

Project Description: H/375035 / H/375142

**Method Quality Control: Duplicate**

Analyte	Result	Reporting Limit	Units	Source Result	%REC	%REC Limit	RPD	RPD Limit	Notes
<b>Anions</b>									
Chloride	ND	5	ug/g	ND			NC	20	
Sulphate	63.6	5	ug/g	72.4			13.0	20	
<b>General Inorganics</b>									
pH	7.12	0.05	pH Units	7.11			0.1	10	
Resistivity	77.5	0.10	Ohm.m	75.9			2.0	20	
<b>Physical Characteristics</b>									
% Solids	80.8	0.1	% by Wt.	81.5			0.9	25	

Certificate of Analysis

Report Date: 24-Dec-2024

Client: Hatch Ltd.

Order Date: 18-Dec-2024

Client PO:

Project Description: H/375035 / H/375142

**Method Quality Control: Spike**

Analyte	Result	Reporting Limit	Units	Source Result	%REC	%REC Limit	RPD	RPD Limit	Notes
<b>Anions</b>									
Chloride	10.8	5	ug/g	ND	105	80-120			
Sulphate	16.9	5	ug/g	7.24	97.0	80-120			

Certificate of Analysis

Report Date: 24-Dec-2024

Client: Hatch Ltd.

Order Date: 18-Dec-2024

Client PO:

Project Description: H/375035 / H/375142

**Qualifier Notes:**

**Sample Data Revisions:**

None

**Work Order Revisions / Comments:**

None

**Other Report Notes:**

n/a: not applicable

ND: Not Detected

MDL: Method Detection Limit

Source Result: Data used as source for matrix and duplicate samples

%REC: Percent recovery.

RPD: Relative percent difference.

NC: Not Calculated

Soil results are reported on a dry weight basis unless otherwise noted.

Where %Solids is reported, moisture loss includes the loss of volatile hydrocarbons.

Any use of these results implies your agreement that our total liability in connection with this work, however arising, shall be limited to the amount paid by you for this work, and that our employees or agents shall not under any circumstances be liable to you in connection with this work.

Parcel ID: 2451324



Parcel Order Number  
(Lab Use Only)

Chain of Custody  
(Lab Use Only)

No 145330

Client Name: <b>Hatch</b>	Project Ref: <b>H/375035 / H/375142</b>	Page <b>1</b> of <b>1</b>
Contact Name: <b>Ted Beadle</b>	Quote #:	<b>Turnaround Time</b> <input type="checkbox"/> 1 day <input type="checkbox"/> 3 day <input type="checkbox"/> 2 day <input checked="" type="checkbox"/> Regular
Address: <b>4342 Queen St. Niagara Falls, ON</b>	PO #:	
Telephone: <b>647-523-5446</b>	E-mail: <b>ted.beadle@hatch.com</b>	
Date Required: _____		

<input type="checkbox"/> REG 153/04 <input type="checkbox"/> REG 406/19 <b>Other Regulation</b> <input type="checkbox"/> Table 1 <input type="checkbox"/> Res/Park <input type="checkbox"/> Med/Fine <input type="checkbox"/> REG 558 <input type="checkbox"/> PW00 <input type="checkbox"/> Table 2 <input type="checkbox"/> Ind/Comm <input type="checkbox"/> Coarse <input type="checkbox"/> CCME <input type="checkbox"/> MISA <input type="checkbox"/> Table 3 <input type="checkbox"/> Agri/Other <input type="checkbox"/> SU - Sani <input type="checkbox"/> SU-Storm <input type="checkbox"/> Table _____ <input type="checkbox"/> Other For RSC: <input type="checkbox"/> Yes <input type="checkbox"/> No <input type="checkbox"/> Other		<b>Matrix Type:</b> S (Soil/Sed.) GW (Ground Water) SW (Surface Water) SS (Storm/Sanitary Sewer) P (paint A (Air) O (Other))	<b>Required Analysis</b>																	
Sample ID/Location Name	Matrix	Air Volume	# of Containers	Sample Taken		PHCs F1-F4+BTEX	VOCs	PAHs	Metals by ICP	Hg	CrVI	B (HWS)	Corrosivity Package							
				Date	Time															
1 TR24-1-C1	Soil		1	Dec.18/24	11:00								X							
2 TR24-6-C1	Soil		1	Dec.18/24	11:00								X							
3 FY24-1-C1	Soil		1	Dec.18/24	11:30								X							
4 FY24-5-C1	Soil		1	Dec.18/24	11:30								X							
5																				
6																				
7																				
8																				
9																				
10																				

Comments:		Method of Delivery: <b>WALK IN</b>	
Relinquished By (Sign):	Received at Depot: <b>B. Bator (Niagara)</b>	Received at Lab: <b>Km</b>	Verified By: <b>Km</b>
Relinquished By (Print):	Date/Time: <b>Dec 18/24 @ 4:50 pm</b>	Date/Time: <b>12/19/24 1035</b>	Date/Time: <b>12/19/24 1035</b>
Date/Time:	Temperature: <b>2°</b> °C	Temperature: <b>6.9</b> °C	pH Verified: <input type="checkbox"/> By: <b>NA</b>

## Certificate of Analysis

**Hatch Ltd.**

4342 Queen Street, Suite 300

Niagara Falls, ON L2E 7J7

Attn: Ted Beadle

Client PO:

Project: H375142

Custody:

Report Date: 12-Aug-2025

Order Date: 1-Aug-2025

**Order #: 2531429**

This Certificate of Analysis contains analytical data applicable to the following samples as submitted:

Parcel ID	Client ID
2531429-01	BH-25-1-S1

Approved By:



Alex Enfield, MSc

Lab Manager

Certificate of Analysis

Report Date: 12-Aug-2025

Client: Hatch Ltd.

Order Date: 1-Aug-2025

Client PO:

Project Description: H375142

**Analysis Summary Table**

Analysis	Method Reference/Description	Extraction Date	Analysis Date
Ignitability	based on EPA 1030	5-Aug-25	5-Aug-25
REG 558 - Cyanide	TCLP MOE E3015- Auto Colour	5-Aug-25	5-Aug-25
REG 558 - Fluoride	TCLP EPA 340.2 - ISE	6-Aug-25	6-Aug-25
REG 558 - Mercury by CVAA	TCLP EPA 7470A, CVAA	7-Aug-25	7-Aug-25
REG 558 - Metals, ICP-MS	TCLP EPA 6020 - Digestion - ICP-MS	7-Aug-25	7-Aug-25
REG 558 - NO3/NO2	TCLP EPA 300.1 - IC	7-Aug-25	7-Aug-25
REG 558 - PCBs	TCLP EPA 608 - GC-ECD	12-Aug-25	12-Aug-25
REG 558 - SVOCs	TCLP EPA 625 - GC-MS	5-Aug-25	6-Aug-25
REG 558 - VOCs	TCLP ZHE EPA 624 - P&T GC-MS	6-Aug-25	7-Aug-25
Solids, %	CWS Tier 1 - Gravimetric	6-Aug-25	7-Aug-25

Certificate of Analysis

Report Date: 12-Aug-2025

Client: Hatch Ltd.

Order Date: 1-Aug-2025

Client PO:

Project Description: H375142

## Summary of Criteria Exceedances

(If this page is blank then there are no exceedances)

Only those criteria that a sample exceeds will be highlighted in red

### Regulatory Comparison:

Paracel Laboratories has provided regulatory guidelines on this report for informational purposes only and makes no representations or warranties that the data is accurate or reflects the current regulatory values. The user is advised to consult with the appropriate official regulations to evaluate compliance. Sample results that are highlighted have exceeded the selected regulatory limit. Calculated uncertainty estimations have not been applied for determining regulatory exceedances.

Sample	Analyte	MDL / Units	Result	Reg 558 Schedule 4	-
--------	---------	-------------	--------	--------------------	---

Certificate of Analysis

Report Date: 12-Aug-2025

Client: Hatch Ltd.

Order Date: 1-Aug-2025

Client PO:

Project Description: H375142

<b>Client ID:</b>	BH-25-1-S1	-	-	-	<b>Criteria:</b> Reg 558 Schedule 4
<b>Sample Date:</b>	22-Jul-25 09:10	-	-	-	
<b>Sample ID:</b>	2531429-01	-	-	-	
<b>Matrix:</b>	Soil	-	-	-	
<b>MDL/Units</b>					

**Physical Characteristics**

% Solids	0.1 % by Wt.	71.2	-	-	-	-
Ignitability	N/A	Negative [1]	-	-	-	-

**EPA 1311 - TCLP Leachate Inorganics**

Fluoride	0.05 mg/L	0.06	-	-	-	150 mg/L	-
Nitrate as N	1 mg/L	<1	-	-	-	1000 mg/L	-
Nitrite as N	1 mg/L	<1	-	-	-	1000 mg/L	-
Cyanide, free	0.02 mg/L	<0.02	-	-	-	20 mg/L	-

**EPA 1311 - TCLP Leachate Metals**

Arsenic	0.05 mg/L	<0.05	-	-	-	2.5 mg/L	-
Barium	0.05 mg/L	0.17	-	-	-	100 mg/L	-
Boron	0.05 mg/L	<0.05	-	-	-	500 mg/L	-
Cadmium	0.01 mg/L	<0.01	-	-	-	0.5 mg/L	-
Chromium	0.05 mg/L	<0.05	-	-	-	5 mg/L	-
Lead	0.05 mg/L	<0.05	-	-	-	5 mg/L	-
Mercury	0.005 mg/L	<0.005	-	-	-	0.1 mg/L	-
Selenium	0.05 mg/L	<0.05	-	-	-	1 mg/L	-
Silver	0.05 mg/L	<0.05	-	-	-	5 mg/L	-
Uranium	0.05 mg/L	<0.05	-	-	-	10 mg/L	-

**EPA 1311 - TCLP Leachate Volatiles**

Benzene	0.005 mg/L	<0.005	-	-	-	0.5 mg/L	-
Carbon Tetrachloride	0.005 mg/L	<0.005	-	-	-	0.5 mg/L	-
Chlorobenzene	0.004 mg/L	<0.004	-	-	-	8 mg/L	-
Chloroform	0.006 mg/L	<0.006	-	-	-	10 mg/L	-
1,2-Dichlorobenzene	0.004 mg/L	<0.004	-	-	-	20 mg/L	-
1,4-Dichlorobenzene	0.004 mg/L	<0.004	-	-	-	0.5 mg/L	-

Certificate of Analysis

Report Date: 12-Aug-2025

Client: Hatch Ltd.

Order Date: 1-Aug-2025

Client PO:

Project Description: H375142

<b>Client ID:</b>	BH-25-1-S1	-	-	-	<b>Criteria:</b> Reg 558 Schedule 4
<b>Sample Date:</b>	22-Jul-25 09:10	-	-	-	
<b>Sample ID:</b>	2531429-01	-	-	-	
<b>Matrix:</b>	Soil	-	-	-	
<b>MDL/Units</b>					

**EPA 1311 - TCLP Leachate Volatiles**

1,2-Dichloroethane	0.005 mg/L	<0.005	-	-	-	0.5 mg/L	-
1,1-Dichloroethylene	0.006 mg/L	<0.006	-	-	-	1.4 mg/L	-
Methyl Ethyl Ketone (2-Butanone)	0.30 mg/L	<0.30	-	-	-	200 mg/L	-
Methylene Chloride	0.04 mg/L	<0.04	-	-	-	5 mg/L	-
Tetrachloroethylene	0.005 mg/L	<0.005	-	-	-	3 mg/L	-
Trichloroethylene	0.004 mg/L	<0.004	-	-	-	5 mg/L	-
Vinyl chloride	0.005 mg/L	<0.005	-	-	-	0.2 mg/L	-
4-Bromofluorobenzene	Surrogate	108%	-	-	-	-	-
Toluene-d8	Surrogate	104%	-	-	-	-	-
Dibromofluoromethane	Surrogate	96.8%	-	-	-	-	-

**EPA 1311 - TCLP Leachate Organics**

2,4-Dinitrotoluene	0.0010 mg/L	<0.0010	-	-	-	0.13 mg/L	-
Benzo [a] pyrene	0.0010 mg/L	<0.0010	-	-	-	0.001 mg/L	-
Nitrobenzene	0.0010 mg/L	<0.0010	-	-	-	2 mg/L	-
Hexachloroethane	0.0010 mg/L	<0.0010	-	-	-	3 mg/L	-
Hexachlorobenzene	0.0500 mg/L	<0.0500	-	-	-	0.13 mg/L	-
Hexachlorobutadiene	0.0010 mg/L	<0.0010	-	-	-	0.5 mg/L	-
2,3,4,6-Tetrachlorophenol	0.0020 mg/L	<0.0020	-	-	-	10 mg/L	-
2,4,5-Trichlorophenol	0.0010 mg/L	<0.0010	-	-	-	400 mg/L	-
2,4,6-Trichlorophenol	0.0010 mg/L	<0.0010	-	-	-	0.5 mg/L	-
2,4-Dichlorophenol	0.0010 mg/L	<0.0010	-	-	-	90 mg/L	-
2-Methylphenol	0.0010 mg/L	<0.0010	-	-	-	200 mg/L	-
3/4-Methylphenol	0.0010 mg/L	<0.0010	-	-	-	200 mg/L	-
Pentachlorophenol	0.0050 mg/L	<0.0050	-	-	-	6 mg/L	-
2,4,6-Tribromophenol	Surrogate	99.2%	-	-	-	-	-

Certificate of Analysis

Report Date: 12-Aug-2025

Client: Hatch Ltd.

Order Date: 1-Aug-2025

Client PO:

Project Description: H375142

<b>Client ID:</b>	BH-25-1-S1	-	-	-	<b>Criteria:</b>
<b>Sample Date:</b>	22-Jul-25 09:10	-	-	-	<b>Reg 558 Schedule 4</b>
<b>Sample ID:</b>	2531429-01	-	-	-	-
<b>Matrix:</b>	Soil	-	-	-	
<b>MDL/Units</b>					

**EPA 1311 - TCLP Leachate Organics**

2-Fluorophenol	Surrogate	32.4% [4]	-	-	-	-
2-Fluorobiphenyl	Surrogate	62.1%	-	-	-	-
Terphenyl-d14	Surrogate	56.1%	-	-	-	-
PCBs, total	0.003 mg/L	<0.003 [1]	-	-	-	0.3 mg/L
Decachlorobiphenyl	Surrogate	109% [1]	-	-	-	-

Certificate of Analysis

Report Date: 12-Aug-2025

Client: Hatch Ltd.

Order Date: 1-Aug-2025

Client PO:

Project Description: H375142

**Method Quality Control: Blank**

Analyte	Result	Reporting Limit	Units	%REC	%REC Limit	RPD	RPD Limit	Notes
<b>EPA 1311 - TCLP Leachate Inorganics</b>								
Fluoride	ND	0.05	mg/L					
Nitrate as N	ND	1	mg/L					
Nitrite as N	ND	1	mg/L					
Cyanide, free	ND	0.02	mg/L					
<b>EPA 1311 - TCLP Leachate Metals</b>								
Arsenic	ND	0.05	mg/L					
Barium	ND	0.05	mg/L					
Boron	ND	0.05	mg/L					
Cadmium	ND	0.01	mg/L					
Chromium	ND	0.05	mg/L					
Lead	ND	0.05	mg/L					
Mercury	ND	0.005	mg/L					
Selenium	ND	0.05	mg/L					
Silver	ND	0.05	mg/L					
Uranium	ND	0.05	mg/L					
<b>EPA 1311 - TCLP Leachate Organics</b>								
2,4-Dinitrotoluene	ND	0.0010	mg/L					
Benzo [a] pyrene	ND	0.0010	mg/L					
Nitrobenzene	ND	0.0010	mg/L					
Hexachloroethane	ND	0.0010	mg/L					
Hexachlorobenzene	ND	0.0500	mg/L					
Hexachlorobutadiene	ND	0.0010	mg/L					
2,3,4,6-Tetrachlorophenol	ND	0.0020	mg/L					
2,4,5-Trichlorophenol	ND	0.0010	mg/L					
2,4,6-Trichlorophenol	ND	0.0010	mg/L					
2,4-Dichlorophenol	ND	0.0010	mg/L					
2-Methylphenol	ND	0.0010	mg/L					
3/4-Methylphenol	ND	0.0010	mg/L					
Pentachlorophenol	ND	0.0050	mg/L					
Surrogate: 2,4,6-Tribromophenol	0.023		%	92.3	40-150			
Surrogate: 2-Fluorobiphenyl	0.013		%	49.9	40-150			

Certificate of Analysis

Report Date: 12-Aug-2025

Client: Hatch Ltd.

Order Date: 1-Aug-2025

Client PO:

Project Description: H375142

**Method Quality Control: Blank**

Analyte	Result	Reporting Limit	Units	%REC	%REC Limit	RPD	RPD Limit	Notes
<i>Surrogate: 2-Fluorophenol</i>	0.0083		%	32.8	40-150			S-GC
<i>Surrogate: Terphenyl-d14</i>	0.019		%	75.7	40-150			
PCBs, total	ND	0.003	mg/L					
<i>Surrogate: Decachlorobiphenyl</i>	0.010		%	103	62-138			
<b>EPA 1311 - TCLP Leachate Volatiles</b>								
Benzene	ND	0.005	mg/L					
Carbon Tetrachloride	ND	0.005	mg/L					
Chlorobenzene	ND	0.004	mg/L					
Chloroform	ND	0.006	mg/L					
1,2-Dichlorobenzene	ND	0.004	mg/L					
1,4-Dichlorobenzene	ND	0.004	mg/L					
1,2-Dichloroethane	ND	0.005	mg/L					
1,1-Dichloroethylene	ND	0.006	mg/L					
Methyl Ethyl Ketone (2-Butanone)	ND	0.30	mg/L					
Methylene Chloride	ND	0.04	mg/L					
Tetrachloroethylene	ND	0.005	mg/L					
Trichloroethylene	ND	0.004	mg/L					
Vinyl chloride	ND	0.005	mg/L					
<i>Surrogate: 4-Bromofluorobenzene</i>	0.776		%	112	50-140			
<i>Surrogate: Dibromofluoromethane</i>	0.632		%	91.5	50-140			
<i>Surrogate: Toluene-d8</i>	0.748		%	108	50-140			

Certificate of Analysis

Report Date: 12-Aug-2025

Client: Hatch Ltd.

Order Date: 1-Aug-2025

Client PO:

Project Description: H375142

**Method Quality Control: Duplicate**

Analyte	Result	Reporting Limit	Units	Source Result	%REC	%REC Limit	RPD	RPD Limit	Notes
<b>EPA 1311 - TCLP Leachate Inorganics</b>									
Fluoride	0.32	0.05	mg/L	0.32			0.6	20	
Nitrate as N	ND	1	mg/L	ND			NC	20	
Nitrite as N	ND	1	mg/L	ND			NC	20	
Cyanide, free	ND	0.02	mg/L	ND			NC	20	
<b>EPA 1311 - TCLP Leachate Metals</b>									
Arsenic	ND	0.05	mg/L	ND			NC	29	
Barium	8.46	0.05	mg/L	8.39			0.9	34	
Boron	0.289	0.05	mg/L	0.281			2.9	33	
Cadmium	0.064	0.01	mg/L	0.066			3.1	33	
Chromium	ND	0.05	mg/L	ND			NC	32	
Lead	1.14	0.05	mg/L	1.13			1.6	32	
Mercury	ND	0.005	mg/L	ND			NC	30	
Selenium	ND	0.05	mg/L	ND			NC	28	
Silver	ND	0.05	mg/L	ND			NC	28	
Uranium	ND	0.05	mg/L	ND			NC	27	
<b>EPA 1311 - TCLP Leachate Organics</b>									
PCBs, total	ND	0.003	mg/L	ND			NC	30	
<i>Surrogate: Decachlorobiphenyl</i>	<i>0.010</i>		%		<i>103</i>	<i>62-138</i>			
<b>EPA 1311 - TCLP Leachate Volatiles</b>									
Benzene	ND	0.005	mg/L	ND			NC	50	
Carbon Tetrachloride	ND	0.005	mg/L	ND			NC	50	
Chlorobenzene	ND	0.004	mg/L	ND			NC	50	
Chloroform	ND	0.006	mg/L	ND			NC	50	
1,2-Dichlorobenzene	ND	0.004	mg/L	ND			NC	50	
1,4-Dichlorobenzene	ND	0.004	mg/L	ND			NC	50	
1,2-Dichloroethane	ND	0.005	mg/L	ND			NC	50	
1,1-Dichloroethylene	ND	0.006	mg/L	ND			NC	50	
Methyl Ethyl Ketone (2-Butanone)	ND	0.30	mg/L	ND			NC	50	
Methylene Chloride	ND	0.04	mg/L	ND			NC	50	
Tetrachloroethylene	ND	0.005	mg/L	ND			NC	50	

Certificate of Analysis

Report Date: 12-Aug-2025

Client: Hatch Ltd.

Order Date: 1-Aug-2025

Client PO:

Project Description: H375142

**Method Quality Control: Duplicate**

Analyte	Result	Reporting Limit	Units	Source Result	%REC	%REC Limit	RPD	RPD Limit	Notes
Trichloroethylene	ND	0.004	mg/L	ND			NC	50	
Vinyl chloride	ND	0.005	mg/L	ND			NC	50	
<i>Surrogate: 4-Bromofluorobenzene</i>	<i>0.750</i>		%		<i>109</i>	<i>50-140</i>			
<i>Surrogate: Dibromofluoromethane</i>	<i>0.590</i>		%		<i>85.5</i>	<i>50-140</i>			
<i>Surrogate: Toluene-d8</i>	<i>0.725</i>		%		<i>105</i>	<i>50-140</i>			
<b>Physical Characteristics</b>									
% Solids	92.2	0.1	% by Wt.	91.9			0.3	25	

Certificate of Analysis

Report Date: 12-Aug-2025

Client: Hatch Ltd.

Order Date: 1-Aug-2025

Client PO:

Project Description: H375142

**Method Quality Control: LCS Dup**

Analyte	Result	Reporting Limit	Units	Source Result	%REC	%REC Limit	RPD	RPD Limit	Notes
<b>EPA 1311 - TCLP Leachate Organics</b>									
2,4-Dinitrotoluene	0.0230	0.0010	mg/L	ND	92.0	50-140	4.63	200	
Benzo [a] pyrene	0.0209	0.0010	mg/L	ND	83.5	50-140	3.26	200	
Nitrobenzene	0.0184	0.0010	mg/L	ND	73.5	50-140	9.55	200	
Hexachloroethane	0.0041	0.0010	mg/L	ND	16.4	50-140	5.82	200	QS-02
Hexachlorobenzene	ND	0.0500	mg/L	ND		50-140		200	QS-01
Hexachlorobutadiene	0.0028	0.0010	mg/L	ND	11.1	50-140	5.95	200	QS-02
2,3,4,6-Tetrachlorophenol	0.0221	0.0020	mg/L	ND	88.4	50-140	0.773	200	
2,4,5-Trichlorophenol	0.0224	0.0010	mg/L	ND	89.5	50-140	4.15	200	
2,4,6-Trichlorophenol	0.0221	0.0010	mg/L	ND	88.4	50-140	4.04	200	
2,4-Dichlorophenol	0.0213	0.0010	mg/L	ND	85.1	50-140	5.33	200	
2-Methylphenol	0.0208	0.0010	mg/L	ND	83.0	50-140	5.37	200	
3/4-Methylphenol	0.0213	0.0010	mg/L	ND	85.0	50-140	4.84	200	
Pentachlorophenol	0.0208	0.0050	mg/L	ND	83.0	50-140	1.89	200	

Certificate of Analysis

Report Date: 12-Aug-2025

Client: Hatch Ltd.

Order Date: 1-Aug-2025

Client PO:

Project Description: H375142

**Method Quality Control: Spike**

Analyte	Result	Reporting Limit	Units	Source Result	%REC	%REC Limit	RPD	RPD Limit	Notes
<b>EPA 1311 - TCLP Leachate Inorganics</b>									
Fluoride	0.81	0.05	mg/L	0.32	98.2	70-130			
Nitrate as N	1	1	mg/L	ND	102	80-120			
Nitrite as N	1	1	mg/L	ND	109	80-120			
Cyanide, free	0.047	0.02	mg/L	ND	94.5	60-136			
<b>EPA 1311 - TCLP Leachate Metals</b>									
Arsenic	0.507	0.05	mg/L	ND	101	83-119			
Barium	0.454	0.05	mg/L	ND	90.8	83-116			
Boron	0.775	0.05	mg/L	0.281	98.7	71-128			
Cadmium	0.543	0.01	mg/L	0.066	95.5	78-119			
Chromium	0.524	0.05	mg/L	ND	105	80-124			
Lead	0.458	0.05	mg/L	ND	91.6	77-126			
Mercury	0.0315	0.005	mg/L	ND	105	70-130			
Selenium	0.459	0.05	mg/L	ND	91.8	81-125			
Silver	0.446	0.05	mg/L	ND	89.2	70-128			
Uranium	0.476	0.05	mg/L	ND	95.2	70-131			
<b>EPA 1311 - TCLP Leachate Organics</b>									
2,4-Dinitrotoluene	0.0220	0.0010	mg/L	ND	87.8	50-140			
Benzo [a] pyrene	0.0202	0.0010	mg/L	ND	80.8	50-140			
Nitrobenzene	0.0167	0.0010	mg/L	ND	66.8	50-140			
Hexachloroethane	0.0043	0.0010	mg/L	ND	17.3	50-140			QS-02
Hexachlorobenzene	ND	0.0500	mg/L	ND		50-140			QS-01
Hexachlorobutadiene	0.0029	0.0010	mg/L	ND	11.8	50-140			QS-02
2,3,4,6-Tetrachlorophenol	0.0219	0.0020	mg/L	ND	87.7	50-140			
2,4,5-Trichlorophenol	0.0215	0.0010	mg/L	ND	85.9	50-140			
2,4,6-Trichlorophenol	0.0212	0.0010	mg/L	ND	84.9	50-140			
2,4-Dichlorophenol	0.0202	0.0010	mg/L	ND	80.7	50-140			
2-Methylphenol	0.0197	0.0010	mg/L	ND	78.7	50-140			
3/4-Methylphenol	0.0202	0.0010	mg/L	ND	81.0	50-140			
Pentachlorophenol	0.0211	0.0050	mg/L	ND	84.6	50-140			
Surrogate: 2,4,6-Tribromophenol	0.025		%		99.9	40-150			

Certificate of Analysis

Report Date: 12-Aug-2025

Client: Hatch Ltd.

Order Date: 1-Aug-2025

Client PO:

Project Description: H375142

**Method Quality Control: Spike**

Analyte	Result	Reporting Limit	Units	Source Result	%REC	%REC Limit	RPD	RPD Limit	Notes
<i>Surrogate: 2-Fluorobiphenyl</i>	0.013		%		53.0	40-150			
<i>Surrogate: 2-Fluorophenol</i>	0.0064		%		25.4	40-150			S-GC
<i>Surrogate: Terphenyl-d14</i>	0.013		%		52.0	40-150			
PCBs, total	0.036	0.003	mg/L	ND	90.1	86-145			
<i>Surrogate: Decachlorobiphenyl</i>	0.011		%		109	62-138			
<b>EPA 1311 - TCLP Leachate Volatiles</b>									
Benzene	37.3	0.005	mg/L	ND	92.7	60-130			
Carbon Tetrachloride	38.6	0.005	mg/L	ND	95.9	60-130			
Chlorobenzene	36.2	0.004	mg/L	ND	90.0	60-130			
Chloroform	37.8	0.006	mg/L	ND	94.4	60-130			
1,2-Dichlorobenzene	36.0	0.004	mg/L	ND	89.6	60-130			
1,4-Dichlorobenzene	36.0	0.004	mg/L	ND	89.5	60-130			
1,2-Dichloroethane	34.9	0.005	mg/L	ND	87.4	60-130			
1,1-Dichloroethylene	36.7	0.006	mg/L	ND	91.3	60-130			
Methyl Ethyl Ketone (2-Butanone)	92.7	0.30	mg/L	ND	92.7	50-140			
Methylene Chloride	38.3	0.04	mg/L	ND	95.8	60-130			
Tetrachloroethylene	37.3	0.005	mg/L	ND	92.8	60-130			
Trichloroethylene	36.4	0.004	mg/L	ND	91.1	60-130			
Vinyl chloride	43.7	0.005	mg/L	ND	108	50-140			
<i>Surrogate: 4-Bromofluorobenzene</i>	0.680		%		98.5	50-140			
<i>Surrogate: Dibromofluoromethane</i>	0.704		%		102	50-140			
<i>Surrogate: Toluene-d8</i>	0.681		%		98.6	50-140			

Certificate of Analysis

Report Date: 12-Aug-2025

Client: Hatch Ltd.

Order Date: 1-Aug-2025

Client PO:

Project Description: H375142

**Qualifier Notes:**

**Sample Qualifiers :**

- 1: Holding time had been exceeded upon receipt of the sample at the laboratory or prior to the analysis being requested.
- 4: Surrogate recovery outside of control limits. The data was accepted based on valid recovery of the remaining surrogate.  
Applies to Samples: BH-25-1-S1

**QC Qualifiers:**

- QS-01 Spike Level is less than the reporting MDL, however, recovery was acceptable.
- QS-02 Spike level outside of control limits. Analysis batch accepted based on other QC included in the batch.
- S-GC Surrogate recovery outside of control limits. The data was accepted based on valid recovery of the remaining surrogate.

**Sample Data Revisions:**

None

**Work Order Revisions / Comments:**

None

**Other Report Notes:**

n/a: not applicable

ND: Not Detected

MDL: Method Detection Limit

Source Result: Data used as source for matrix and duplicate samples

%REC: Percent recovery.

RPD: Relative percent difference.

NC: Not Calculated

Soil results are reported on a dry weight basis unless otherwise noted.

Where %Solids is reported, moisture loss includes the loss of volatile hydrocarbons.

Any use of these results implies your agreement that our total liability in connection with this work, however arising, shall be limited to the amount paid by you for this work, and that our employees or agents shall not under any circumstances be liable to you in connection with this work.

Parcel ID: 2531429



**Chain Of Custody**  
(Lab Use Only)

Client Name: Hatch Ltd. Project Ref: H375142  
 Contact Name: Ted Beadle Quote #: #25-360  
 Address: 4342 Queen St., Suite 300, Niagara Falls PO #:  
 Telephone: (905) 374-0701 E-mail: Tim

Page \_\_\_ of \_\_\_  
**Turnaround Time**  
 1 day  3 day  
 2 day  Regular  
 Date Required: \_\_\_\_\_

REG 153/04  REG 406/19 **Other Regulation**  
 Table 1  Agri/Other  Med/Fine  REG 558  PWQO  
 Table 2  Res/Park  Coarse  CCME  MISA  
 Table 3  Ind/Comm  SU - Sani  SU - Storm  
 Table \_\_\_\_\_ Mun: \_\_\_\_\_  
 For RSC:  Yes  No  Other: Reg 558 Schedule 4

**Matrix Type:** S (Soil/Sed.) GW (Ground Water)  
 SW (Surface Water) SS (Storm/Sanitary Sewer)  
 P (Paint) A (Air) O (Other)

Sample ID/Location Name	Matrix	Air Volume	# of Containers	Field Filtered	Sample Taken		Required Analysis											
					Date	Time	Ignitability	SVOCs	VOCs	M&I	PCBS	Pesticides & Herbicides (Full list)						
1																		
2 BH-25-1-S1	S				07/22/25	9:10am	X	X	X	X	X	X						
3																		
4																		
5																		
6																		
7																		
8																		
9																		
10																		

Comments: Reg . REG 558, Full Schedule 4 - TCLP (less DF/NDMA) Method of Delivery: Walk In

Unless otherwise negotiated by the parties, by signing Paracel's Chain of Custody form, you are agreeing to Paracel Laboratories Terms and Conditions and are subject to the terms and conditions thereof. Available at www.paracellabs.com

Relinquished By (Sign):	Received at Depot: C-Plu	Received at Lab:	Verified By: C-Plu
Relinquished By (Print): Tim Van Heuvelen	Date/Time: 08/16/25 9:16	Date/Time:	Date/Time: 08/10/25 10:20
Date/Time: July 24th, 2025	Temperature: 26.1 °C	Temperature:	pH Verified: <input type="checkbox"/> By:

## Subcontracted Analysis

**Hatch Ltd.**

4342 Queen Street, Suite 300  
Niagara Falls, ON L2E 7J7

Attn: Ted Beadle

Paracel Report No. **2531429**

Client Project(s): **H375142**

Client PO:

Reference: **#25-360 - H375142**

Order Date: 01-Aug-25

Report Date: 25-Aug-25

CoC Number:

---

Sample(s) from this project were subcontracted for the listed parameters. A copy of the subcontractor's report is attached

**Paracel ID**

**Client ID**

**Analysis**

2531429-01

BH-25-1-S1

REG 558 - Pesticides & Herbicides- full list



**TESTMARK Laboratories Ltd.**

Committed to Quality and Service

## CERTIFICATE OF ANALYSIS

Client:	Alex Enfield	Work Order Number:	591450
Company:	Paracel Laboratories Ltd. - Hamilton	PO #:	
Address:	351 Nash Rd. N Unit 9b Hamilton, ON, L8H7P4	Regulation:	O.Reg. 558 - Schedule 4
Phone:	(905) 631-2077	Project #:	2531429
Email:	aenfield@paracellabs.com	DWS #:	
		Sampled By:	
Date Order Received:	8/6/2025	Analysis Started:	8/13/2025
Arrival Temperature:	14 C	Analysis Completed:	8/22/2025

### WORK ORDER SUMMARY

ANALYSES WERE PERFORMED ON THE FOLLOWING SAMPLES. THE RESULTS RELATE ONLY TO THE ITEMS TESTED.

Sample Description	Lab ID	Matrix	Type	Comments	Date Collected	Time Collected
BH-25-1-S1	2181115	Soil	None		7/22/2025	9:10 AM
BH-25-1-S1 TCLP	2181454	Leachate	None		8/6/2025	

### METHODS AND INSTRUMENTATION

THE FOLLOWING METHODS WERE USED FOR YOUR SAMPLE(S):

Method	Lab	Description	Reference
Carbamate TCLP (A57)	Garson	Determination of Carbamate Pesticides, Diuron and Glyphosate by HPLC	Modified from SW846-8318A
Diquat/Paraquat TCLP (A70)	Garson	Determination of Diquat and Paraquat in TCLP Leachate by HPLC/ DAD	Modified from EPA 549.2
Glyphosate TCLP (A82)	Garson	Determination of Glyphosate in Water	Modified from EPA 547
OCPs TCLP (A19)	Garson	Determination of Organochlorine Pesticides in TCLP Extract by GC/ECD	Modified from SW846-8081B
OPPest TCLP (A18)	Garson	Determination of Triazine Herbicides and Organophosphorus Pesticides in Leachate	Modified from SW846-8270D, SW846-8141B
PhenoxyHerb TCLP (A56)	Garson	Determination of Phenoxy Acid Herbicides in Leachate by GC/ECD/ECD	Modified from SW846-8151A
TCLP Leachate Extraction (A99)	Garson	TCLP Leachate Extraction of Soils	EPA Method 1311
Toxaphene TCLP (A19)	Garson	Determination of Toxaphene in TCLP by GC/ECD	Modified from SW846-8080



**TESTMARK Laboratories Ltd.**

Committed to Quality and Service

## CERTIFICATE OF ANALYSIS

Paracel Laboratories Ltd. - Hamilton

Work Order Number: 591450

This report has been approved by:

Brad Halvorson, B.Sc.  
Laboratory Director

### WORK ORDER RESULTS

<b>Sample Description</b>	BH - 25 - 1 - S1 TCLP			
<b>Sample Date</b>	8/6/2025 12:00 AM			
<b>Lab ID</b>	2181454			
<b>Carbamate Pesticides (TCLP)</b>	<b>Result</b>	<b>MDL</b>	<b>Units</b>	<b>Criteria: O.Reg. 558 - Schedule 4</b>
Aldicarb	<100	100	ug/L	900
Bendiocarb	<100	100	ug/L	4000
Carbaryl	<100	100	ug/L	9000
Carbofuran	<100	100	ug/L	9000
Diuron	<1000	1000	ug/L	15000
Pyridine	<1000	1000	ug/L	5000
Temephos	<100	100	ug/L	28000

<b>Sample Description</b>	BH - 25 - 1 - S1 TCLP			
<b>Sample Date</b>	8/6/2025 12:00 AM			
<b>Lab ID</b>	2181454			
<b>Herbicides (TCLP)</b>	<b>Result</b>	<b>MDL</b>	<b>Units</b>	<b>Criteria: O.Reg. 558 - Schedule 4</b>
Glyphosate	<20	20	ug/L	28000



## CERTIFICATE OF ANALYSIS

Paracel Laboratories Ltd. - Hamilton

Work Order Number: 591450

<b>Sample Description</b>	BH - 25 - 1 - S1 TCLP			
<b>Sample Date</b>	8/6/2025 12:00 AM			
<b>Lab ID</b>	2181454			
<b>OC Pesticides (TCLP)</b>	<b>Result</b>	<b>MDL</b>	<b>Units</b>	<b>Criteria: O.Reg. 558 - Schedule 4</b>
2,4'-DDT	<0.01	0.01	ug/L	~
4,4'-DDD	<0.01	0.01	ug/L	~
4,4'-DDE	<0.01	0.01	ug/L	~
4,4'-DDT	<0.01	0.01	ug/L	~
Aldrin	<0.01	0.01	ug/L	~
Decachlorobiphenyl (Surr.)	110	N/A	% Rec	~
Dieldrin	<0.01	0.01	ug/L	~
Endrin	<0.01	0.01	ug/L	20
Heptachlor	<0.01	0.01	ug/L	~
Heptachlor epoxide	<0.01	0.01	ug/L	~
Methoxychlor	<10	10	ug/L	90000
β-BHC	<0.01	0.01	ug/L	~
α - Chlordane	<0.01	0.01	ug/L	~
α-BHC	<0.01	0.01	ug/L	~
γ - Chlordane	<0.01	0.01	ug/L	~
γ-BHC (Lindane)	<0.01	0.01	ug/L	400
δ-BHC	<0.01	0.01	ug/L	~



**TESTMARK Laboratories Ltd.**

Committed to Quality and Service

## CERTIFICATE OF ANALYSIS

Paracel Laboratories Ltd. - Hamilton

Work Order Number: 591450

Sample Description	BH - 25 - 1 - S1 TCLP			
Sample Date	8/6/2025 12:00 AM			
Lab ID	2181454			
OP Pesticides (TCLP)	Result	MDL	Units	Criteria: O.Reg. 558 - Schedule 4
Atrazine	<0.2	0.2	ug/L	~
Azinphos-methyl (Guthion)	<0.2	0.2	ug/L	2000
Chlorpyrifos (Dursban)	<0.2	0.2	ug/L	9000
Cyanazine (Bladex)	<0.3	0.3	ug/L	1000
Desethyl atrazine	<0.1	0.1	ug/L	~
Diazinon	<0.2	0.2	ug/L	2000
Dimethoate	<0.2	0.2	ug/L	2000
Malathion	<0.1	0.1	ug/L	19000
Methyl parathion	<0.3	0.3	ug/L	700
Metolachlor	<0.1	0.1	ug/L	5000
Metribuzin (Sencor)	<0.1	0.1	ug/L	8000
Parathion	<0.2	0.2	ug/L	5000
Phorate	<0.2	0.2	ug/L	200
Simazine	<0.2	0.2	ug/L	1000
Terbufos	<0.1	0.1	ug/L	100
Triallate	<0.1	0.1	ug/L	23000
Tributyl Phosphate (Surr.)	93.6	N/A	% Rec	~
Trifluralin	<0.1	0.1	ug/L	4500



**TESTMARK Laboratories Ltd.**

Committed to Quality and Service

## CERTIFICATE OF ANALYSIS

Paracel Laboratories Ltd. - Hamilton

Work Order Number: 591450

<b>Sample Description</b>	BH - 25 - 1 - S1 TCLP			
<b>Sample Date</b>	8/6/2025 12:00 AM			
<b>Lab ID</b>	2181454			
<b>Pesticides (TCLP)</b>	<b>Result</b>	<b>MDL</b>	<b>Units</b>	<b>Criteria: O.Reg. 558 - Schedule 4</b>
Diquat	<1	1	ug/L	7000
Paraquat	<0.5	0.5	ug/L	1000

<b>Sample Description</b>	BH - 25 - 1 - S1 TCLP			
<b>Sample Date</b>	8/6/2025 12:00 AM			
<b>Lab ID</b>	2181454			
<b>Phenoxyacid Herbicides (TCLP)</b>	<b>Result</b>	<b>MDL</b>	<b>Units</b>	<b>Criteria: O.Reg. 558 - Schedule 4</b>
2,4,5-T	<10	10	ug/L	28000
2,4-D	<10	10	ug/L	10000
Bromoxynil	<10	10	ug/L	500
Dicamba	<10	10	ug/L	12000
Dichlorophenyl acetic acid (Surr.)	58.9	N/A	% Rec	~
Diclofop-methyl	<10	10	ug/L	900
Dinoseb	<10	10	ug/L	1000
Picloram	<70	70	ug/L	19000
Silvex	<10	10	ug/L	1000



**TESTMARK Laboratories Ltd.**

*Committed to Quality and Service*

## CERTIFICATE OF ANALYSIS

Paracel Laboratories Ltd. - Hamilton

Work Order Number: 591450

Sample Description	BH - 25 - 1 - S1 TCLP			
Sample Date	8/6/2025 12:00 AM			
Lab ID	2181454			
Toxaphene	Result	MDL	Units	Criteria: O.Reg. 558 - Schedule 4
Decachlorobiphenyl (Surr.)	64.2	N/A	% Rec	~
Toxaphene	<70	70	ug/L	500

### LEGEND

Dates: Dates are formatted as mm/dd/year throughout this report.

Matrix: If the matrix is a leachate, the sample was extracted according to Regulation 558.

MDL: Method detection limit or minimum reporting limit.

% Rec: Surrogate compounds are added to the sample in some cases and the recovery is reported as a % recovered.

~: In a criteria column indicates the criteria is not applicable for the parameter row.

Organic Soil Analysis: Data reported for organic analysis in soils samples are corrected for moisture content.

Quality Control: All associated Quality Control data is available on request.

Field Data: Reports containing Field Parameters represent data that has been collected and provided by the client. Testmark is not responsible for the validity of this data which may be used in subsequent calculations.

Sample Condition Deviations: A noted sample condition deviation may affect the validity of the result. Results apply to the sample(s) as received.

Reproduction of Report: Report shall not be reproduced, except in full, without the approval of Testmark Laboratories Ltd.

Regulation Comparisons: Disclaimer: Please note that regulation criteria are provided for comparative purposes, however the onus on ensuring the validity of this comparison rests with the client.



Client Name: Hatch Ltd.	Project Ref: H375142	Page ___ of ___
Contact Name: Ted Beadle	Quote #: #25-360	Turnaround Time <input type="checkbox"/> 1 day <input type="checkbox"/> 3 day <input type="checkbox"/> 2 day <input checked="" type="checkbox"/> Regular
Address: 4342 Queen St., Suite 300, Niagara Falls	PO #:	
Telephone: (905) 374-0701	E-mail: Tim	Date Required: _____

<input type="checkbox"/> REG 153/04	<input type="checkbox"/> REG 406/19	Other Regulation
<input type="checkbox"/> Table 1	<input type="checkbox"/> Agri/Other	<input checked="" type="checkbox"/> REG 558
<input type="checkbox"/> Table 2	<input type="checkbox"/> Res/Park	<input type="checkbox"/> PWQO
<input type="checkbox"/> Table 3	<input type="checkbox"/> Ind/Comm	<input type="checkbox"/> CCME
<input type="checkbox"/> Table _____		<input checked="" type="checkbox"/> SU - Sani
For RSC: <input type="checkbox"/> Yes <input type="checkbox"/> No		<input type="checkbox"/> SU - Storm
		Mun: _____
		<input type="checkbox"/> Other: Reg 558 Schedule 4

Matrix Type: S (Soil/Sed.) GW (Ground Water)  
SW (Surface Water) SS (Storm/Sanitary Sewer)  
P (Paint) A (Air) O (Other)

Required Analysis

Sample ID/Location Name	Matrix	Air Volume	# of Containers	Field Filtered	Sample Taken		Ignitability	SVOCs	VOCs	M&I	PCBs	Pesticides & Herbicides (Full List)
					Date	Time						
1												
2 BH-25-1-S1	S				07/22/25	9:10am	X	X	X	X	X	
3												
4												
5												
6												
7												
8												
9												
10												

Comments: Reg . REG 558, Full Schedule 4 - TCLP (less DF/NDMA)

Method of Delivery: Walk In

Unless otherwise negotiated by the parties, by signing Paracel's Chain of Custody form, you are agreeing to Paracel Laboratories Terms and Conditions and are subject to the terms and conditions thereof. Available at www.paracellabs.com

Relinquished By (Sign):	Received at Depot: C-Plu	Received at Lab:	Verified By: C-Plu
Relinquished By (Print): Tim Van Heuvelen	Date/Time: 08/16/25 9:16	Date/Time:	Date/Time: 08/10/25 10:20
Date/Time: July 24th, 2025	Temperature: 26.1 °C	Temperature:	pH Verified: <input type="checkbox"/> By:

# Appendix E

## Electrical Resistivity Testing

Project Report

February 14, 2025

## Brookfield Renewable

### Electrical Resistivity Field Testing

#### Table of Contents

1. Introduction.....	2
2. Methodology .....	2
3. Field Work .....	3
4. Limitations of Use.....	6
5. Closure .....	7

## 1. Introduction

This report presents the results of the Vertical Electric Sounding survey carried out by Hatch on November 27, 2024, at the South March Battery Energy Storage System (BESS) site in Dunrobin, Ontario. The objective of the survey was to conduct soil resistivity tests using the 4-electrode Wenner method at the site.

## 2. Methodology

The Wenner 4-electrode method is also known as a vertical electric resistivity sounding (VES). This method is described by ASTM G57-06 and ANSI/IEEE Standard 81-1983 standards. To determine the soils resistivity, four evenly spaced steel electrodes are inserted into the soil in a straight line and a DC or AC test current is applied to the outer two electrodes. The associated potential difference  $V$  is measured between the inner pair of potential electrodes. The effective resistance  $R$  of subsurface material is measured and converted to units of Ohms using Ohms' law,  $R=V/I$ . The influence of each specific electrode spacing between electrodes is then converted to the soils apparent resistivity using the geometrical correction factor  $\rho_a, \Omega \cdot m = 2\pi a R$  where  $(a)$  is the electrode spacing in meters. The apparent resistivity is then reported in units of ohm-metres ( $\Omega \cdot m$ ).

The test is carried out by keeping the test instrument at central location, while the  $a$ -spacing between the current electrodes (C1 and C2) and potential electrodes (P1 and P2) is increased outwards from the central location in steps in order to achieve greater depth penetration (see Figure 1 below). The survey depth increases with increasing electrode separation to yield a vertical electrical sounding of the subsurface. This approach highlights changes in vertical stratification in electrical properties of the ground. Where possible, the test array is then rotated 90 degrees creating two orthogonal spreads about a common midpoint to investigate the possibility of planar anisotropy in the ground where space permits.

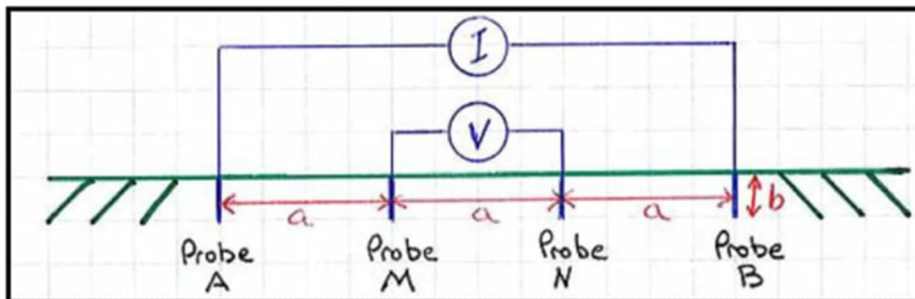

Figure 1: Typical Wenner Array Configuration

The data were acquired with the following standards as guidelines.

- ASTM Standard G 57, 2006, "Standard Test Method for Field Measurement of Soil Resistivity Using the Wenner Four-Electrode Method," ASTM International, West Conshohocken, PA.

- ANSI/IEEE Standard 81, 1983, "Guide for Measuring Earth Resistivity, Ground Impedance, and Earth Surface Potentials of a Ground System," The Institute of Electrical and Electronics Engineers, Inc., New York, NY, USA.

### 3. Field Work

Two intersecting VES lines were collected. The VES data were acquired using a Syscal R1 Plus soil resistivity meter using the 4-electrode Wenner survey. Electrode 'a'-spacings of 0.61, 1.5, 3.0, 6.1, 15.2, 30.5, and 61.0 m were employed for Line A, and 0.61, 1.5, 3.0, 6.1, 15.2, 30.5, and 36.6 m for Line B.

Cold, windy and sunny conditions persisted throughout the duration of the field testing. Temperature ranged from -1 and 5 degrees Celsius.

The ground surface at the South March BESS site is grass covered, and soil conditions were moist at the time of testing due to light rain in the previous day. Terrain is generally flat.

Figure 2 displays a general project location map indicating the VES test location.



Figure 2: Site Map Showing VES Test Location (Red Line)

Table 1 shows the NAD 83 MTM Zone 9 coordinates for each VES line. Table 2 and 3 shows the measurements taken on site and Figures 3 and 4 presents the graphical results of the VES data.

**Table 1: Coordinates of VES Lines**

Line	Location of Point	Easting (m)	Northing (m)	Approximate Elevation (masl)
<b>A</b>	West End	340,557.11	5,028,466.98	100.89
	Mid-Point	340,622.44	5,028,532.00	100.89
	East End	340,686.68	5,028,598.05	100.43
<b>B</b>	North End	340,548.64	5,028,545.91	100.89
	Mid-point	340,596.32	5,028,511.54	100.89
	South End	340,635.99	5,028,479.48	102.89

**Table 2: Measured Data of VES Line A**

Electrode Spacing (a) m	Pin Depth (d) m	Voltage (mV)	Current (mA)	Resistance $\Omega$	Apparent Resistivity ( $\Omega$ -m)
0.61	0.06	3,273.55	161.36	20.29	77.67
1.5	0.15	805.59	245.42	3.28	31.42
3.0	0.15	709.60	334.07	2.12	40.66
6.1	0.15	685.09	370.32	1.85	70.82
15.2	0.15	831.43	440.58	1.89	180.61
30.5	0.2	988.93	495.64	2.00	381.92
61.0	0.2	1,006.02	480.76	2.09	801.09

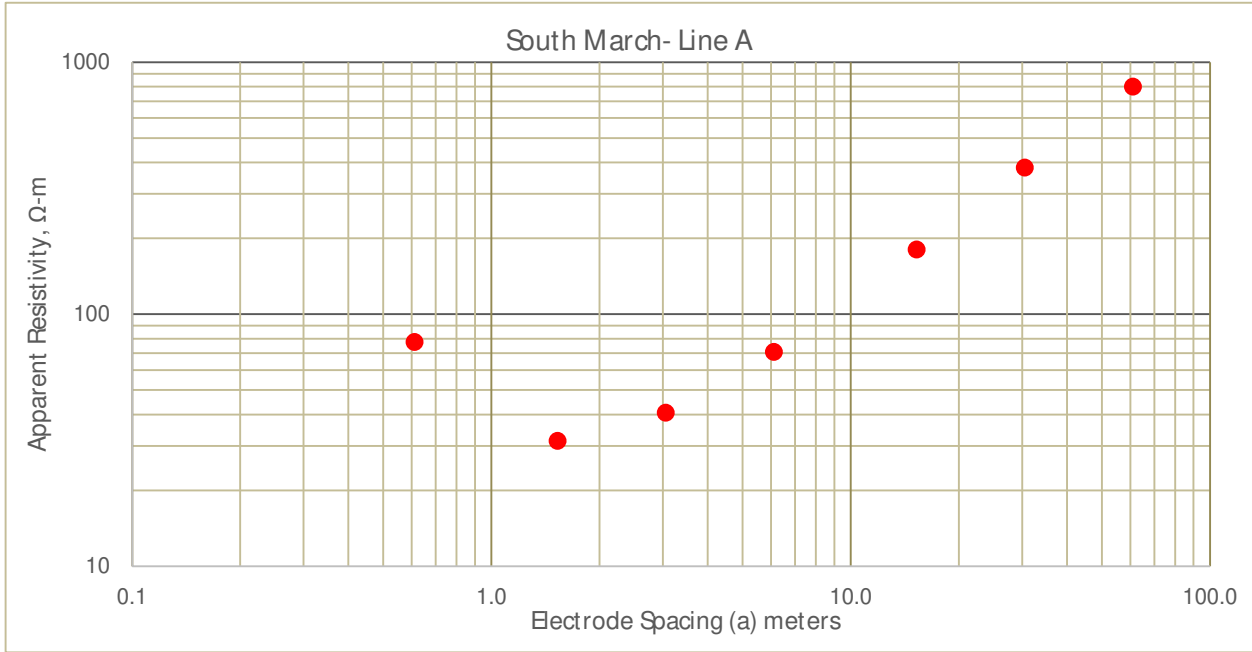

**Figure 3: Graphical Presentation of Measured VES Data Line A**

**Table 3: Measured Data of VES Line B**

Electrode Spacing (a) m	Pin Depth (d) m	Voltage (mV)	Current (mA)	Resistance Ω	Apparent Resistivity (Ω-m)
0.61	0.06	3,305.08	157.93	20.93	80.12
1.5	0.15	890.95	233.74	3.81	36.48
3.0	0.15	565.65	267.68	2.11	40.45
6.1	0.15	587.37	327.27	1.79	68.71
15.2	0.15	901.00	465.61	1.94	185.20
30.5	0.2	405.25	153.18	2.65	506.40
36.6	0.2	518.69	186.63	2.78	638.38

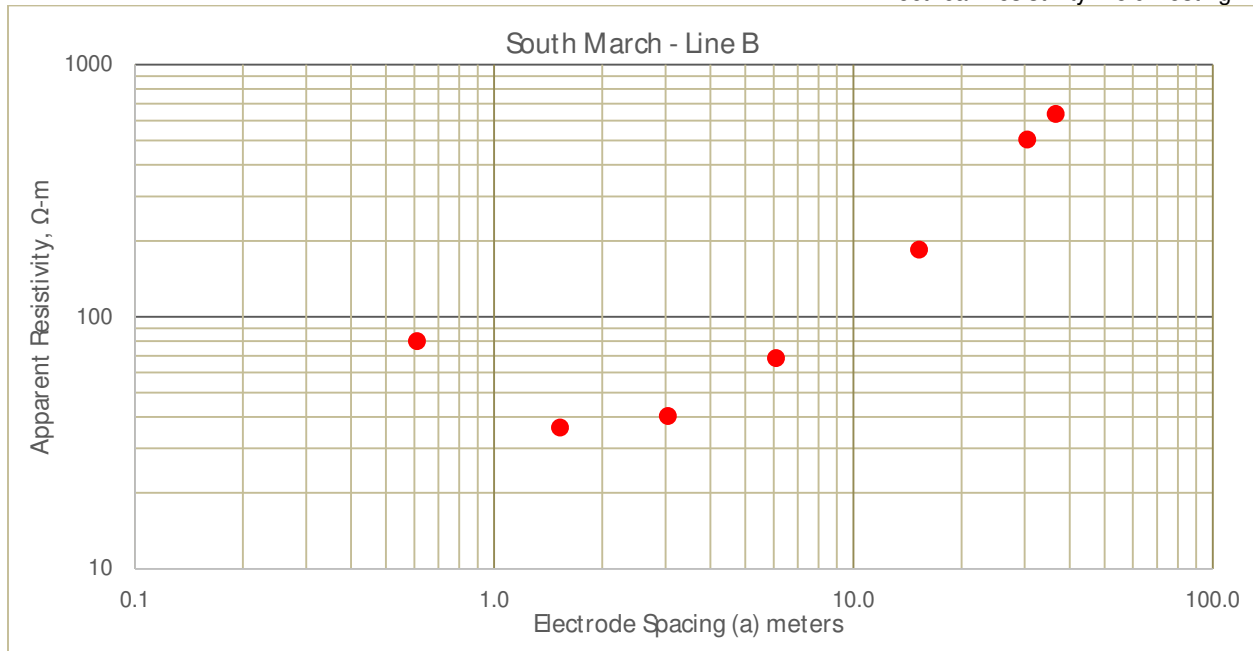

**Figure 4: Graphical Presentation of Measured VES Data Line B**

## 4. Limitations of Use

The geophysical method presented in this report is based on the use of geophysical surveying techniques. As with any geophysical method, values presented in this report should be confirmed by intrusive methods (boreholes, test pits, etc.).

This geophysical survey was carried out in a manner consistent with the level of care and skill normally exercised by other members of the engineering and science professions currently practising under similar conditions, subject to the time limits and financial and physical constraints applicable to the services provided. This is a factual report therefore no warranty is either expressed, implied, or made as to the conclusions, advice, and recommendations offered.

Any use of the information within this report made by a third party, or any reliance on, or decisions to be made based on it, are the sole responsibility of such third parties. Hatch accepts no responsibility for damages, if any, suffered by any third party as a result of decisions made or actions taken based on this report.

## 5. Closure

We trust that this technical memorandum meets your needs at the present time. If you have any questions or require clarification, please contact the undersigned at your convenience.

Ralph Serluca C.Tech  
*Civil Technologist*

# Appendix F

## Rock Core Photographs



FY24-1- Box 1 - 6.14 m - 9.14 m



FY25-1- Box 1 – 5.70 m – 10.55 m

# Appendix G

## Conceptual Foundation Drawings

DWG. No.

GENERAL NOTES

- 1. THIS SKETCH PRESENTS VARIOUS TYPES OF FOUNDATIONS TO BE USED FOR THE SOUTH MARCH BESS PROJECT AND IS BASED ON THE GEOTECHNICAL REPORT H375142-0000-2A0-066-0001. REFER TO GEOTECHNICAL REPORT FOR FURTHER FOUNDATION DETAILS.
- 2. DUE TO THE VARYING DEPTH OF BEDROCK ON THE SITE, CONTRACTOR TO SELECT THE MOST OPTIMAL OPTION BASED ON THE ACTUAL SOIL CONDITIONS.
- 3. CONTRACTOR IS RESPONSIBLE FOR DETAIL DESIGN OF ALL FOUNDATIONS TO BE CONSTRUCTED BY THEM.
- 4. FOR DEAD LOADS AND MANUFACTURER REQUIREMENTS FOR FOUNDATION DESIGN, REFER TO THE DOCUMENT "DW\_20241019\_ST5015UX-4H-US\_STRUCTURE DRAWING AND THE FOUNDATION DIAGRAM\_V5".

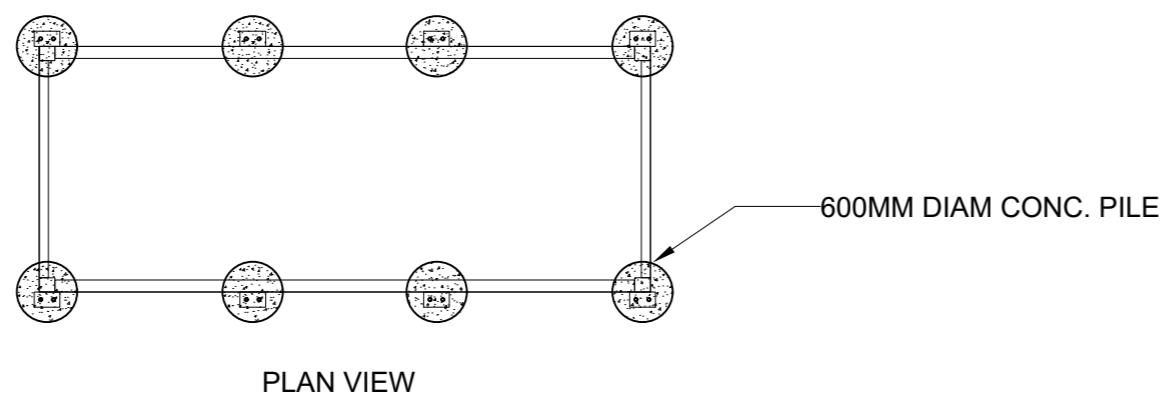
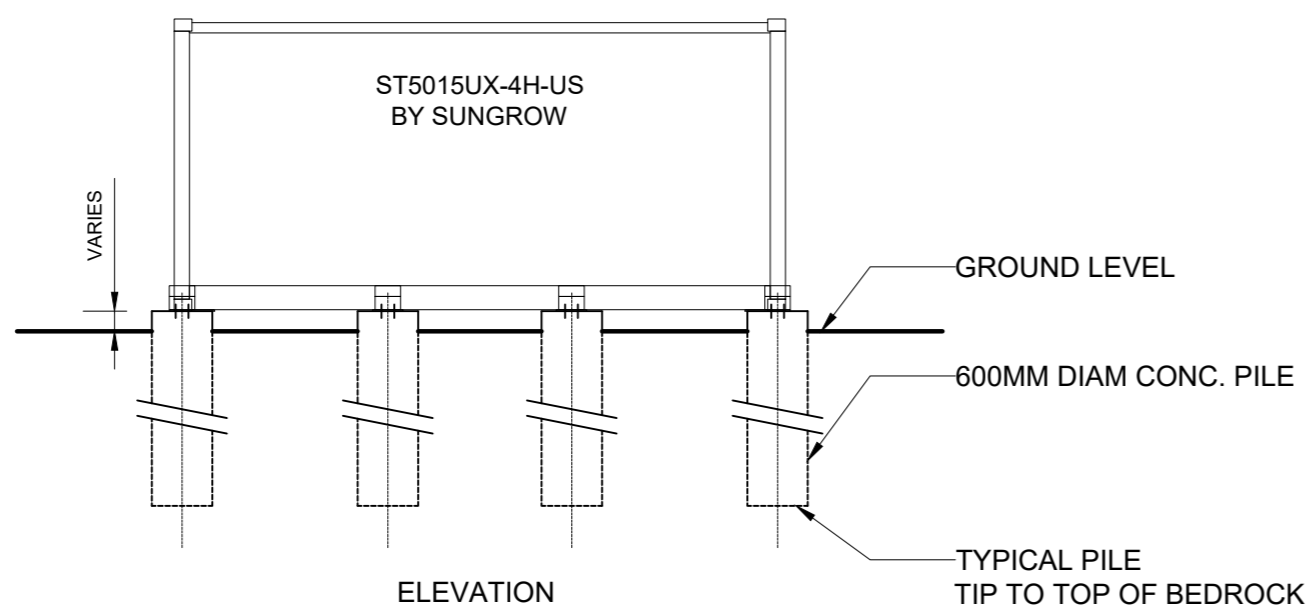

TYPE 1:  
CONCRETE CAISSON PILE

NOTES:

- 1. PILE TIP ELEVATION TO BE DETERMINED ACCORDING TO SUBSURFACE CONDITIONS ENCOUNTERED BY THE CONSTRUCTION CONTRACTOR. SEE GEOTECHNICAL REPORT.
- 2. THE USE OF TEMPORARY CAISSON LINERS TO BE DETERMINED BY CONSTRUCTION CONTRACTOR.
- 3. A FACTORED PILE RESISTANCE OF 500 KN AT ULTIMATE LIMIT STATES (ULS) WITH THE TIP INSTALLED TO TOP OF BEDROCK CAN BE USED FOR DESIGN PURPOSES.

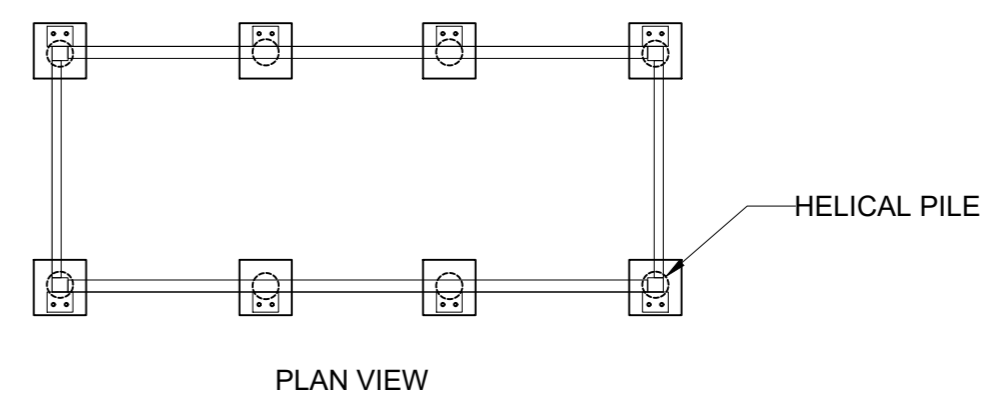
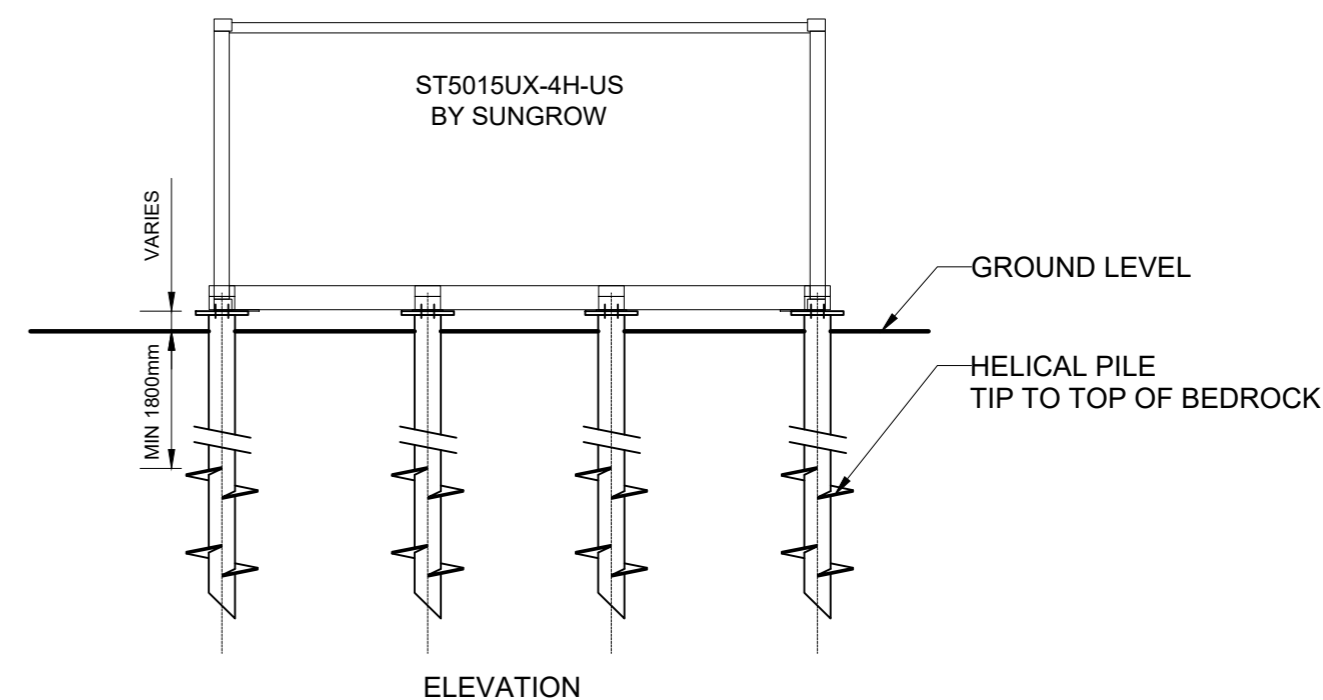

TYPE 2:  
HELICAL PILE

NOTES:

- 1. PILE TIP ELEVATION TO BE DETERMINED ACCORDING TO SUBSURFACE CONDITIONS ENCOUNTERED BY THE CONSTRUCTION CONTRACTOR.
- 2. HELICAL PILE GEOTECHNICAL RESISTANCE TO BE DETERMINED BY PROPRIETARY DESIGNER.
- 3. A FACTORED PILE RESISTANCE OF 500 KN AT ULTIMATE LIMIT STATES (ULS) WITH THE TIP INSTALLED TO TOP OF BEDROCK CAN BE USED FOR DESIGN PURPOSES.

NOT FOR CONSTRUCTION

HATCH

DRAFTSPERSON  
DESIGNER  
CHECKER  
DESIGN COORD.  
RESP. ENG.  
LEAD DISC. ENG.  
ENG. MANAGER  
PROJ. MANAGER

SOUTH MARCH BESS  
DEEP FOUNDATION

Ref No	-	A	ISSUED FOR INFORMATION	MB	AK	2025/07/18
--------	---	---	------------------------	----	----	------------

DRAWING No.	DRAWING TITLE	No.	DESCRIPTION	BY	CHK'D	DATE
-------------	---------------	-----	-------------	----	-------	------

ROLE	NAME	SIGNATURE	DATE
------	------	-----------	------

SCALE N.T.S. OR AS NOTED	DWG. No.	REV A
--------------------------------	----------	----------

REFERENCE DRAWINGS	REVISIONS	DRAWING APPROVAL STATUS:
--------------------	-----------	--------------------------

DWG. No.

GENERAL NOTES

- THIS SKETCH PRESENTS VARIOUS TYPES OF FOUNDATIONS TO BE USED FOR THE SOUTH MARCH BESS PROJECT AND IS BASED ON THE GEOTECHNICAL REPORT H3750142-0000-2A0-066-0001. REFER TO GEOTECHNICAL REPORT FOR FURTHER FOUNDATION DETAILS.
- DUE TO THE VARYING DEPTH OF BEDROCK ON THE SITE, CONTRACTOR TO SELECT THE MOST OPTIMAL OPTION BASED ON THE ACTUAL SOIL CONDITIONS.
- CONTRACTOR IS RESPONSIBLE FOR DETAIL DESIGN OF ALL FOUNDATIONS TO BE CONSTRUCTED BY THEM.
- FOR DEAD LOADS AND MANUFACTURER REQUIREMENTS FOR FOUNDATION DESIGN REFER TO THE DOCUMENT "DW\_20241019\_ST5015UX-4H-US\_STRUCTURE DRAWING AND THE FOUNDATION DIAGRAM\_V5".

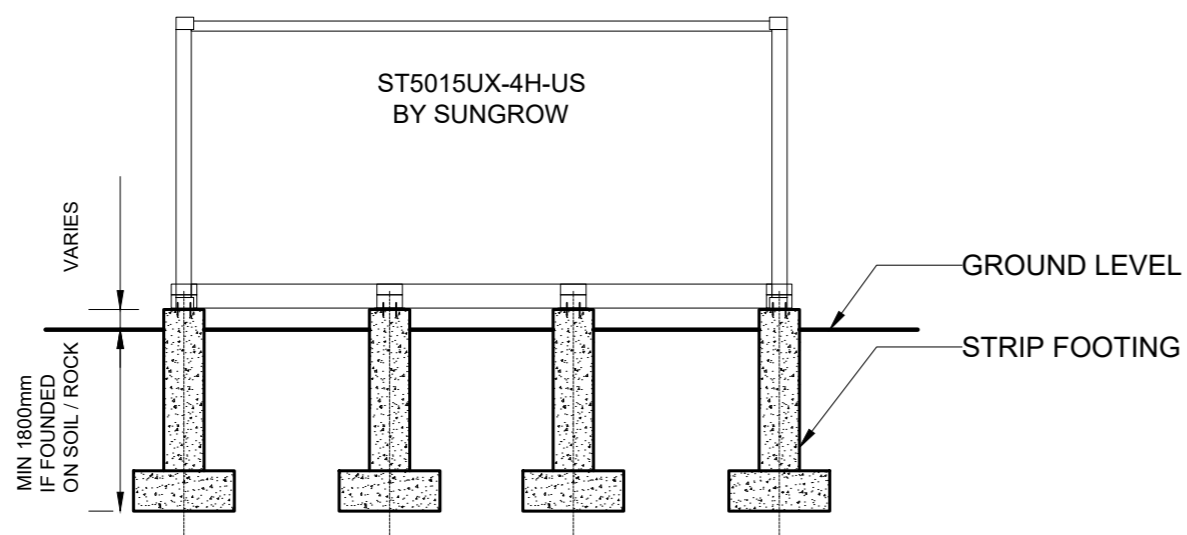

ELEVATION

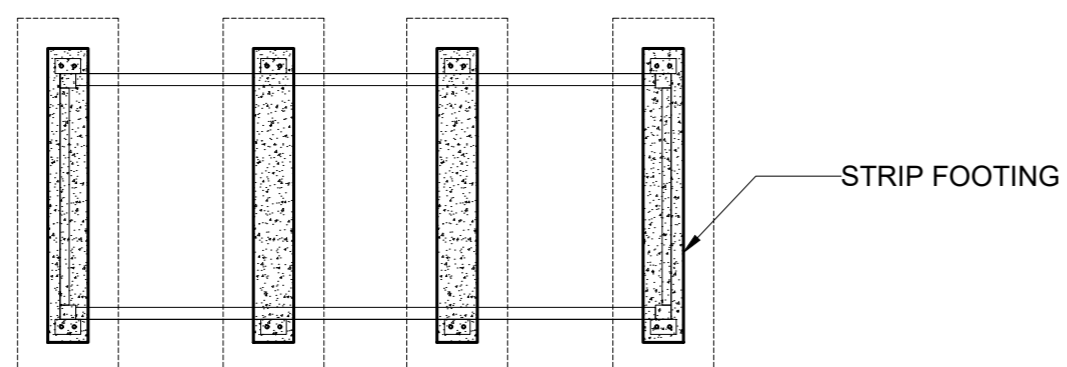

PLAN VIEW

TYPE 3:  
CONCRETE STRIP FOOTING  
ACROSS THE LENGTH

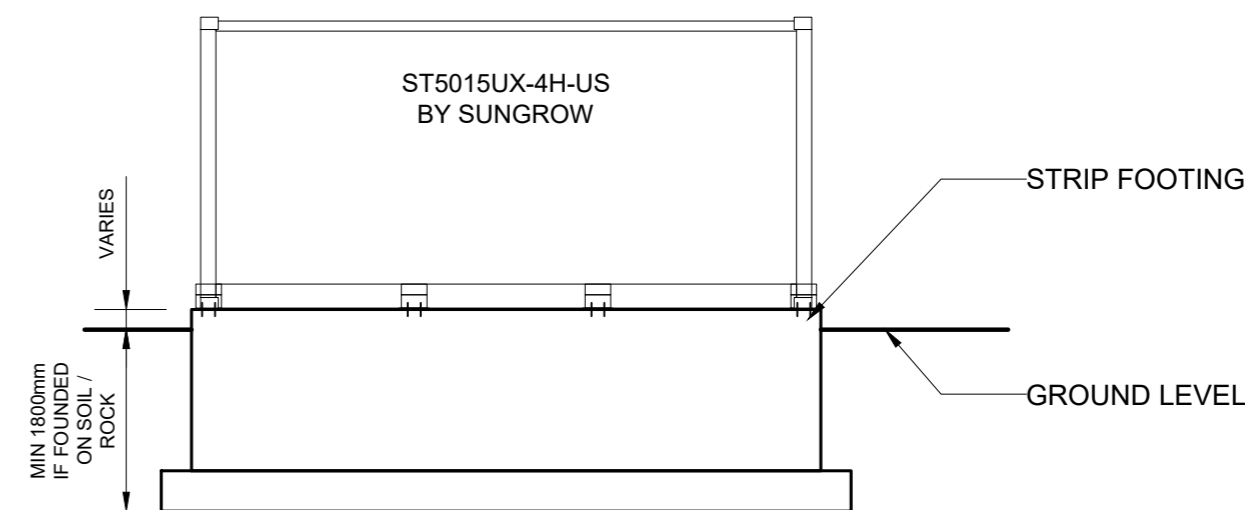

ELEVATION

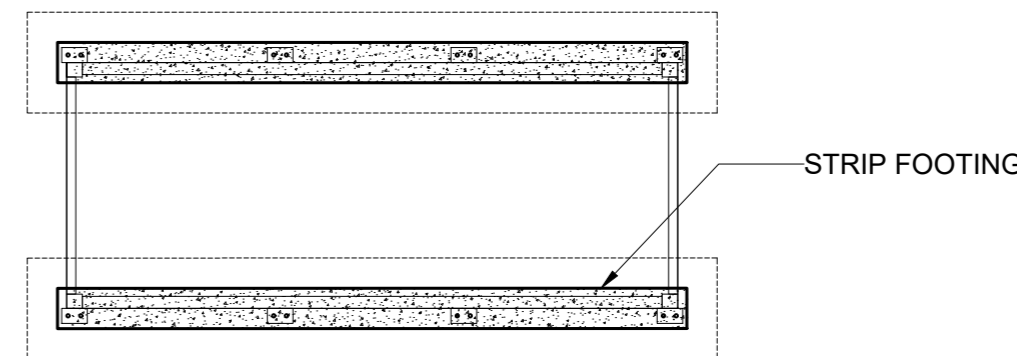

PLAN VIEW

TYPE 4:  
CONCRETE STRIP FOOTING  
ALONG THE LENGTH

**NOT FOR CONSTRUCTION**

**HATCH**

DRAFTSPERSON  
DESIGNER  
CHECKER  
DESIGN COORD.  
RESP. ENG.  
LEAD DISC. ENG.  
ENG. MANAGER  
PROJ. MANAGER

**SOUTH MARCH BESS  
SHALLOW FOUNDATION**

Ref No	-	A	ISSUED FOR INFORMATION	MB	AK	2025/07/18
--------	---	---	------------------------	----	----	------------

DRAWING No.	DRAWING TITLE	No.	DESCRIPTION	BY	CHK'D	DATE	ROLE	NAME	SIGNATURE	DATE
REFERENCE DRAWINGS			REVISIONS			DRAWING APPROVAL STATUS:				

SCALE	DWG. No.	REV
N.T.S.		A
OR AS NOTED		

# Appendix H

## Geophysics Report



# **GEOPHYSICAL REPORT**

**HATCH**

**REFRACTION BEDROCK TOMOGRAPHY MAPPING, MASW AND TERRAIN  
CONDUCTIVITY METER (EM31) FOR FITZROY BESS PROJECT**

**2555 & 2625 Marchurst Road, Dunrobin, ON**



## Table of Contents

General Overview .....	3
Personnel.....	3
Methodology .....	4
Geonics EM-31 MK2 .....	4
Seismic Refraction and Multi-channel Analysis of Surface Waves (MASW) .....	5
Data Processing And Interpretation .....	7
Geonics EM-31 MK2 .....	7
Seismic Refraction, MASW and MAM .....	8
Seismic Refraction .....	8
MASW/MAM .....	8
Contours and Mapping .....	9
Results .....	9
Seismic Line Locations .....	9
Boreholes.....	10
EM31 Quadrature Map.....	11
EM31 In-Phase Map .....	11
Seismic Line and Borehole Map .....	12
MASW/MAM .....	13
Bedrock Results .....	17
Table 1: Seismic Lines .....	9
Table 2: Borehole Logs.....	10
Table 3: Elastic Moduli Calculations from MASW Data .....	16
Figure 1: Overview Map with the extent of survey area in red	3
Figure 2: Geonics EM-31 Mk2 on site	5
Figure 3: Seismic 3-meter Spacing Field Setup, Geophones (orange), Shot Locations (red)	6
Figure 4: ABEM Terraloc Pro 2 – 24 Channel Seismograph with 4.5Hz geophones.	7
Figure 5: EM-31 Quadrature Ground Conductivity Map	11
Figure 6: EM-31 In-Phase Magnetic Susceptibility Map	11
Figure 7: EM-31 Quadrature Phase Ground Conductivity Map with Seismic Line and Borehole Overlay	12
Figure 8: EM-31 In-Phase Magnetic Susceptibility Map with Seismic Line and Borehole Overlay	12
Figure 9: Combined Active & Passive Dispersion Curve for the MASW test	13
Figure 10: Summary of Site Class based upon Shear-wave velocities	15
Figure 11: Vs30 Layer model of Line 3 on site in Dunrobin, ON	<b>Error! Bookmark not defined.</b>
Figure 12: Bedrock Depth Plot	<b>Error! Bookmark not defined.</b>
Figure 13: Surface Elevation Plot (provided by Hatch)	18
Figure 14: Bedrock Elevation Plot	19



## **GENERAL OVERVIEW**

A future BESS (Battery Energy Storage System) is proposed with a footprint spanning across 2555 & 2625 Marchurst Road in Dunrobin, ON. Simcoe Geoscience (herein referred to as Simcoe) was requested by HATCH to conduct seismic site class testing and bedrock tomography mapping spanning an area roughly encompassing the extents of the operation (Buildings, structures and buried utilities). A Geonics EM31-mk2 Terrain Conductivity Meter combined with seismic refraction, seismic MASW and a few boreholes to generate a bedrock tomography map. Figure 1 shows the extent of the scanned area using all geophysical methods.



Figure 1: Overview Map with the extent of survey area in red

### **Personnel**

<b>Personnel</b>	<b>Title</b>	<b>Dates on site</b>
Anthony Situm	GIT	March 30th – April 4th, 2025
Mitchell Osmond	GIT	March 30th – April 4th, 2025
Lhoucin Taghya, P.Geo.	Geophysicist	Remote off Site
Milan Situm, P.Geo.	Geophysicist	Remote off Site



## **METHODOLOGY**

The following background information provides an explanation of the principals involved, equipment utilized, survey design, and the interpretive process.

### **Geonics EM-31 MK2**

#### ***Basic Theory***

The instrument works on the principle of a source coil transmitting a primary magnetic field which induces a current in conductive material all around the instrument above and below ground. This primary field induces a secondary magnetic field within the footprint of influence and this secondary field can be measured by the instrument. Two secondary fields can be measured:

1. The quadrature (out-of-phase) component is the measure of apparent conductivity which is measured in millisiemens per meter (mS/m).
2. The in-phase component measures the ratio of the secondary to primary magnetic field and is measured in parts per thousand (ppt). The in-phase is a measurement of magnetic susceptibility which is a measure of a material's ability to maintain a magnetic field after being exposed to an electromagnetic field. Generally, anything with metal has the highest susceptibility which is why the dataset tends to expose materials with high metal content or larger individual metallic objects.

#### ***Survey Design***

Bedrock elevation topography is the primary focus, thus understanding overburden thickness is a crucial step in the process of this undertaking. From borehole records taken previous to the site visit, the understanding of overburden substrate is found to be mostly silty clay in a relatively shallow overburden (mostly <10m) covering the proposed survey area.

The fundamental idea is that most clays have a conductivity range of 30 to 100 mS/m. If there is 5 or more meters of clay, then the conductivity range will be at its maximum depending on the moisture content and clay type. If there is bedrock (granitics) within 5 meters, then the conductivity values drop because the conductivity reading will encompass a portion of very resistive rock. A plan map of soil conductivities is generated converted to understand a general idea of bedrock depths based on these values. The EM product is a contour map of bedrock depths where the bedrock is from surface to 5 meters depth. However, for the areas with more than 5 meters a supplementary seismic technique is needed, which will be discussed in the seismic section. For calibrating the presented values, three measurement "zeroing" methods are commonly used, all of which were present on site. Using provided boreholes which reach competent bedrock (3 locations), exposed surface bedrock (abundant), and seismic results.

#### ***Positioning***

The GPS coordinates are recorded with a Juniper DGPS Geode device that can communicate with a cellular phone by Bluetooth. The accuracy of the X,Y coordinates should be within 10 centimeters. In order to cover



the property properly, the instrument's lateral range of detection was taken into consideration therefore a 10 meter of separation between profiles was chosen. The instrument and operator can be tracked and their path recorded and displayed on a tablet in real-time so the operator could maintain even coverage. Obstructions on site were mostly avoided, with only some small patches of thorny bushes and a swamp to the north-east being too hazardous to pass. Figure 2 shows the EM-31 Mk2 device on site.



Figure 2: Geonics EM-31 Mk2 on site

## **Seismic Refraction and Multi-channel Analysis of Surface Waves (MASW)**

### ***Basic Theory***

Seismic Refraction and MASW are geophysical seismic methods used to determine the subsurface structure and properties of soil and rock. Seismic Refraction utilizes compressional waves (push-pull, sometimes called P waves). Seismic Refraction is based on the principle that P waves refract or bend as they pass through layers of with different velocities. The velocity of the wave is related to the elastic properties of the material it is passing through, which means that the speed of the wave changes as it moves through different layers. By analysing the time, it takes for waves to travel through the subsurface and the angles at which they refract, geophysicists can determine the depth, thickness, and velocity of subsurface layers. This information is used to create a profile that shows the subsurface structure.



Multichannel Analysis of Surface Waves (MASW) and Microtremor Array Measurements (MAM) utilizes ‘rolling’ waves also called Raleigh waves and measuring how each frequency component dissipates with distance. Dissipation rates of each frequency can be modelled to produce the thickness of soil layers based upon their shear-wave velocities. The plot of the variation in frequency speeds is called a ‘dispersion’ plot. The final product is the conversion to shear-wave velocities (divide by 0.9) and ultimately a plot of shear-wave velocity with depth.

### **Field Procedure**

The field setup of a MASW or Refraction survey involves the layout of 24 geophones in a linear array. There may be other array designs depending on the site and aim of the survey. Data acquisition involves generating an acoustic wave with a sledgehammer (commonly there are several other sources possible) and digitally recording the rolling surface waves from the moment of source impact for a full second as it passes the entire array of sensors (geophones).

For this study, data was collected with ABEM Terraloc Pro 2™ seismograph - 24 channels and 4.5 Hz geophones. Figure 4 shows both pieces of equipment. A sledgehammer was used as the primary energy source with traces being recorded at 7 locations: one shot at centre, two shots at 6m and 20m offset beyond the end of the line and two shots between the first two and last two geophones. Each shot records P and S waves simultaneously. Figure 3 shows typical field setup for 3-meter receiver interval. Note that the shot locations are different in Figure 3 than in the executed survey. It is common to adjust shot locations depending on factors such as rock depth, field conditions (like noise) and intended requirements for the survey.

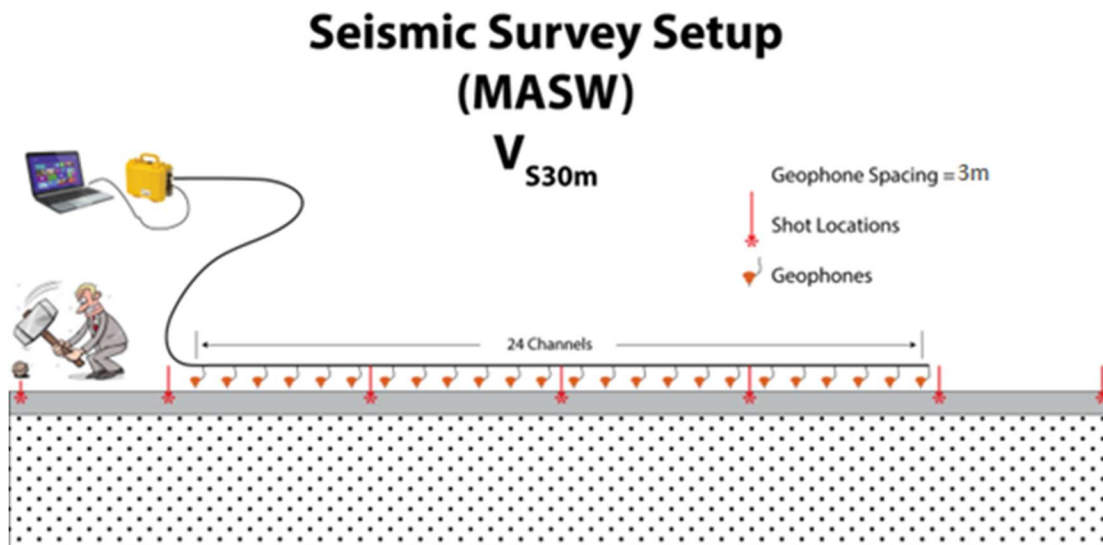

Figure 3: Seismic 3-meter Spacing Field Setup, Geophones (orange), Shot Locations (red)

The passive survey (MAM) used the same geophone array set up as for the MASW survey. Unlike the MASW survey, the MAM method is considered a “passive source” method. There is no time break, and the motions recorded are from ambient energy generated by cultural noise such as traffic, wind, wave motion, etc. Data collection for the passive method involved recording approximately 10 minutes of background “noise” for this sounding.



The records generated by the MAM method contain lower frequency data because they typically originate from long distances, thus increasing the data modelling to greater depths. Typically, the MAM results help clarify the MASW results for depths greater than 20 m; however, the direction of noise propagation relative to the spread orientation can influence the results. Presently on site, this was not a primary factor as bedrock was relatively shallow and noise was minimal.



Figure 4: ABEM Terraloc Pro 2 – 24 Channel Seismograph with 4.5Hz geophones.

## **DATA PROCESSING AND INTERPRETATION**

### **Geonics EM-31 MK2**

Two programs, Surfer and Oasis Montaj are used to examine and present collected EM-31-mk2 data.

To ensure a minimization of data errors, the operator notes all possible sources of data distortion and contamination on site. The EM-31 will react strongly to the presence of standing water bodies as they are highly conductive, so these are noted. Metal contaminants are also highly conductive and magnetically susceptible, which will display localized data spikes which are undesired anomalies irrelevant to this survey's objective. The quadrature (out-of-phase) component is the measure of apparent conductivity, which for our intention of mapping clay overburden to bedrock is a primary focus of the instrument's recording ability. When processing, very sharp anomalies are deleted and water bodies noted, yielding a clearer and more accurate image. Exposed bedrock and shallow (less than a meter) overburden will give low to near zero values of in-phase and conductivity. Ground truthing from the seismic methods and the three boreholes made it possible to convert the conductivity values to a bedrock depth.

The colour contour maps for conductivity and magnetic susceptibility are shown in Figures 5 and 6 respectively.



## Seismic Refraction, MASW and MAM

### Seismic Refraction

The analysis of seismic data in this report was conducted using the *SeisImager*<sup>™</sup> software suite, particularly, employing the *Pickwin*<sup>™</sup> and *Plotrefa*<sup>™</sup> modules in conjunction with the forward model tomography method. Data collected from the field, consisting of seismic waves' arrival times recorded by geophones, is initially imported into the *Pickwin*<sup>™</sup> module. In *Pickwin*<sup>™</sup>, the first arrival times of the refracted waves are meticulously identified in time ('time picked').

Following the 'picking' process, the selected data is exported to the *Plotrefa*<sup>™</sup> module. An initial refraction model is generated, visualizing the subsurface layers and their respective seismic compressional velocities. The model serves as a preliminary representation, providing an initial understanding of the subsurface conditions and characteristics.

The forward model tomography method is then applied to refine this initial model. It involves the construction of a hypothetical subsurface model, wherein the seismic waves' travel times are calculated and compared against the actual picked arrival times. An iterative approach is employed to adjust the model's parameters, aiming to minimize the discrepancies between the calculated and picked arrival times. Each iteration enhances the model's accuracy, offering a more precise depiction of the subsurface's structure and layers. When combined with the shear-wave velocity information several material properties can be calculated including Poissons' and various moduli (Young's, Bulk, etc.). Real-world hard data numbers are excellent at narrowing the parameters, with boreholes (that reach bedrock) being the best.

### MASW/MAM

The MASW data was processed and interpreted using *SeisImager*<sup>™</sup> Surface Wave Analysis to generate a 1-D (depth) shear-wave velocity ( $V_s$ ) profile. The active (MASW) and passive (MAM) data were post-processed, and individual dispersion curves were generated and stacked to generate one average dispersion 1D sounding with the highest signal-to-noise (S/N) ratio. Two separate dispersion images were generated, i.e., active, and passive records.

The passive image was prepared by stacking all individual dispersion images processed from twenty (20) passive field records. This indicates surface wave energy accumulation at relatively lower frequencies (e.g.,  $\leq 10$  Hz) where the active image significantly lacks any meaningful energy trend.

Finally, both active and passive dispersion images were combined to generate one combined dispersion curve that has the highest resolution and the broadest bandwidth. In the overall dispersion trend, extracting the fundamental-mode dispersion curve ( $M_0$ ), which then indicates that the modal interpretation of  $M_0$  is more confident in the combined image. This also has the final 1-D velocity ( $V_s$ ) profile which will have an increased confidence level at deeper depths (e.g.,  $\geq 20$  m) because of the lower frequencies (e.g.,  $\leq 10$  Hz) thus can then be extracted for the  $M_0$  curve. The  $M_0$  curve was then used to generate the final 1-D shear-wave velocity ( $V_s$ ) profile through the subsequent inversion process. The smoothing of the curve helped to minimize the noise of the data, which could produce extra layers in the 1D results.



For this site passive, MAM records were not very critical because the rock was entirely under 10 meters depth. The 3-meter geophone spacing was best suited for bedrock depth greater than 6 meters, in addition the surface topography was flat. The 1-D plot is overlain on each refraction image. In areas where bedrock is within 6 meters of depth, refraction is the preferred processing methods to accompany MASW, as it is best at capturing the bedrock depth, thus yielding a better 1-D velocity curve to measure Vs from.

### Contours and Mapping

The final presentation of data is compiled in Surfer to overlay a map of the site. A 3D tomography contour combining EM-31, Refraction and MASW data is broken down in the appendix and attached files in this report.

## RESULTS

### Seismic Line Locations

The following Table 1 is a summary of the profiles collected by Profile #, Start and End UTM coordinates Vs30 and profile length. All seismic line coordinates were contained within UTM Zone 18T. The profile locations and boreholes are shown overlain on conductivity and in-phase plots in Figures 7 and 8 respectively. Surface topography changes were very gentle, with the entire area being relatively flat. The beginning and end surface elevation of the seismic lines is provided in Table 1, with no hills or significant undulations along any line. A precise elevation and UTM table of each geophone is provided in the appendix of this report. A LIDAR scan of the property producing surface elevations was provided by Hatch.

The individual profiles Appendix A employ a consistent interpretation of the top of bedrock for preliminary reporting purposes. With subsequent supplementary data this may change. The profiles incorporate:

1. Topography & Tomography
2. A pseudo section of compressional wave velocities
3. A MASW 1D sounding.
4. Boreholes where available.

Table 1: Seismic Lines

Profile #	Start UTM	End UTM	Start and End Elevation	Length (meters)
1	418078.00 m E, 5027564.00 m N	418156.00 m E, 5027447.00 m N	99m 99m	138
2	418400.00 m E, 5027676.00 m N	418140.00 m E, 5027566.00 m N	99m 99m	276 (plus a 6 metres river gap)
3	418343.00 m E, 5027705.00 m N	418366.00 m E, 5027496.00 m N	98m 100m	207
4	418304.00 m E, 5027430.00 m N	418453.00 m E, 5027574.00 m N	100m 100m	207
5	418454.00 m E, 5027510.00 m N	418308.00 m E, 5027362.00 m N	101m 101m	207



6	418416.00 m E, 5027496.00 m N	418379.00 m E, 5027554.00 m N	100m 100m	69
7	418352.00 m E, 5027457.00 m N	418405.00 m E, 5027410.00 m N	100m 101.5m	69

**Boreholes**

Previous to the site visit, eight boreholes were drilled and their logs were provided to Simcoe for reference. Their locations and depth to bedrock or depth at refusal are in the following Table 2. Refusal is a term that does not necessarily mean that bedrock is confirmed, only that drilling couldn't pass a certain point at a reasonable rate, for instance a particular sized rock which "refuses" to break may be sufficient for drillers to cease a borehole. Three boreholes did confirm bedrock, which was all granitic gneiss bedrock. A confirmed bedrock depth point is an excellent way to benchmark refraction picks and adjusting EM-31 settings for exacting measurement. All boreholes coordinates were contained within UTM zone 18T.

Table 2: Borehole Logs

Name	UTM Location	Surface Elevation	Bedrock Depth
Borehole FY24-1	418376.00 m E, 5027438.00 m N	100.89m	6.14m
Borehole FY24-2	418213.00 m E, 5027553.00 m N	100.19m	Refusal at 1.2m
Borehole FY24-3	418256.00 m E, 5027606.00 m N	99.04m	Refusal at 2.85m
Borehole FY24-4	418286.00 m E, 5027537.00 m N	100.10m	Refusal at 1.05m
Borehole FY24-5	418388.00 m E, 5027594.00 m N	99.22m	7.55m
Borehole FY24-6	418429.00 m E, 5027525.00 m N	100.43m	Refusal at 3.55m
Borehole FY24-7	418503.00 m E, 5027492.00 m N	103.20m	4.65m
Borehole FY24-8	418440.00 m E, 5027429.00 m N	102.89m	Refusal at 0.75m



### EM31 Quadrature Map

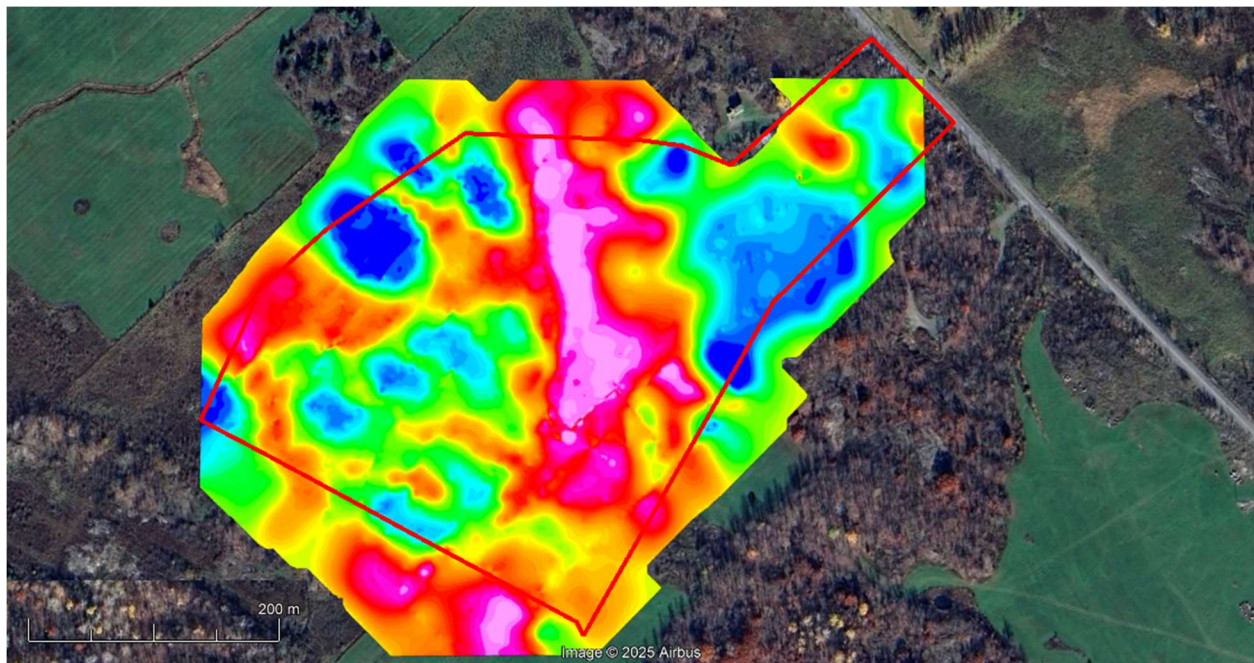

Figure 5: EM-31 Quadrature Ground Conductivity Map

### EM31 In-Phase Map

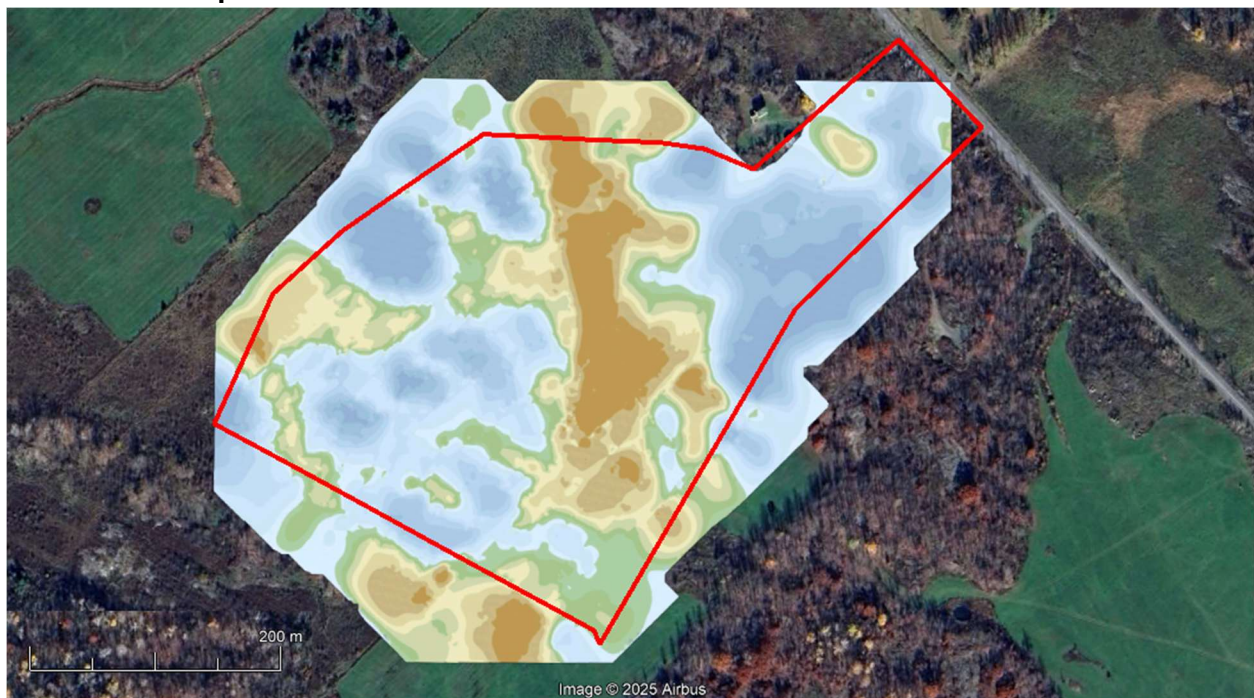

Figure 6: EM-31 In-Phase Magnetic Susceptibility Map



Seismic Line and Borehole Map

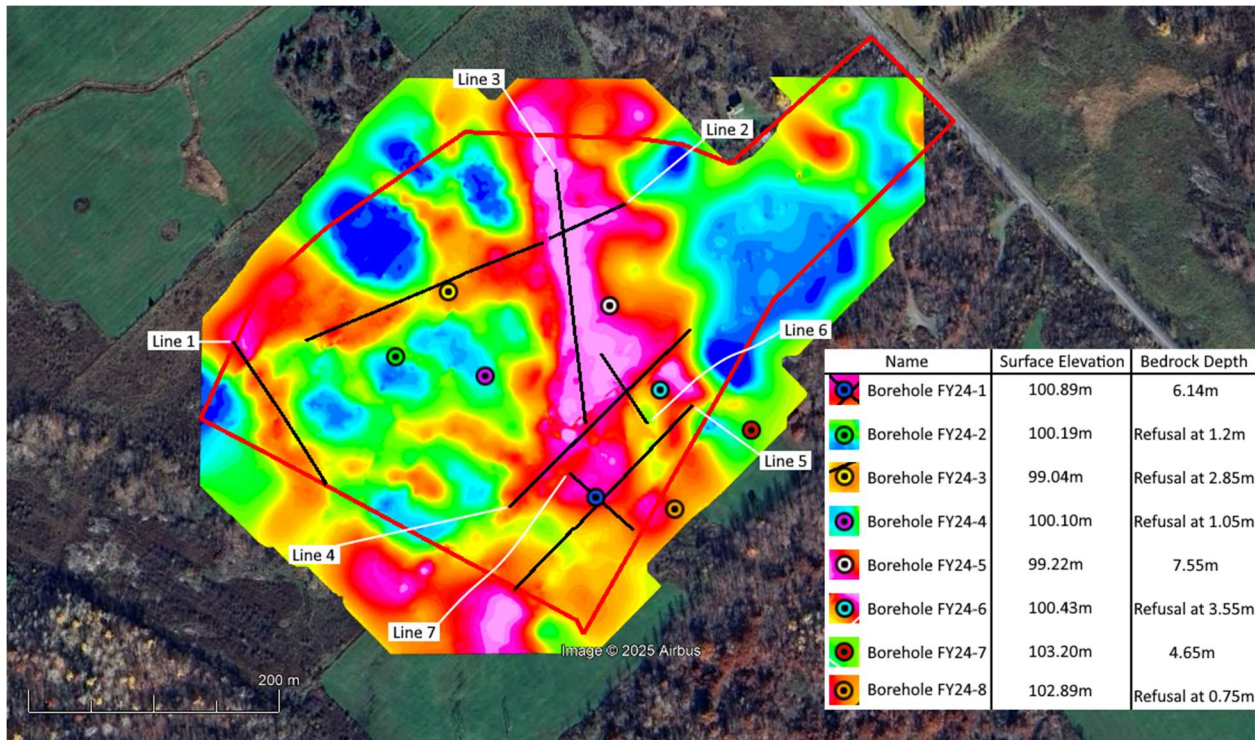

Figure 7: EM-31 Quadrature Phase Ground Conductivity Map with Seismic Line and Borehole Overlay

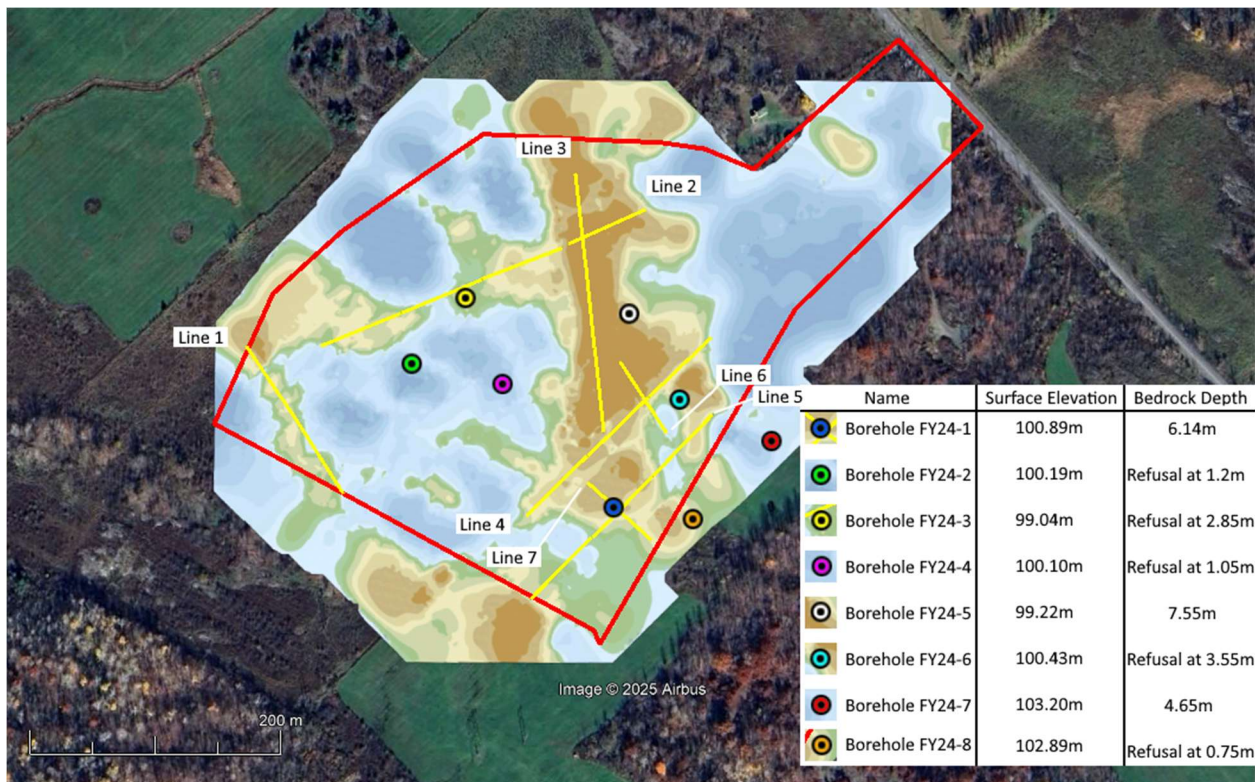

Figure 8: EM-31 In-Phase Magnetic Susceptibility Map with Seismic Line and Borehole Overlay



### MASW/MAM

The Rayleigh dispersion curves obtained from the active and passive datasets were of excellent quality. The cultural noise caused by ambient wind was minimal, the nearby river was slow moving and no precipitation or traffic caused any interference via ground noise. The inverted model (see Figure 11) suggests that the bedrock is shallow, thus within readable depth.

Line 3 (see Figure 8) is the line referenced in this MASW calculation, which is the deepest and thus the “weakest” of the total examined area. Borehole FY24-5 is nearby (about 20 meters away) from the centre of the MASW line. The bedrock depth from this borehole shows it to be 7.55m, the deepest recorded of all boreholes drilled on site.

The following Figure 9 is the dispersion curve from Line 3. Figure 10 is the model from the MASW/MAM sounding.

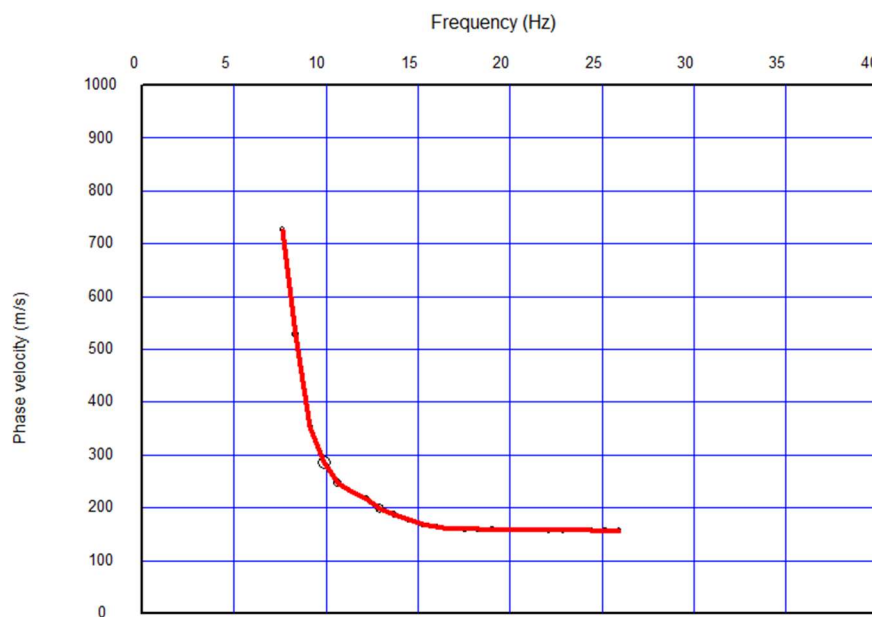

Figure 9: Combined Active & Passive Dispersion Curve for the MASW test

Shear wave velocities for the first 2 meters are characteristic of typical topsoil, often saturated to within a meter of surface. Velocities in this area are typical of topsoil, at about 150-160m/s. The basis material for the soil is silty clay with low plasticity and some trace sand. The velocity of this clay layer steadily increases with depth as compaction builds atop itself, there is evidence of a thin till layer just before bedrock, judging from other boreholes in the area. Velocity of the overburden layer reaches about 300-320m/s as a maximum before reaching the granitic bedrock layer. Following the refraction models, bedrock is predicted to be about 11 metres deep here.

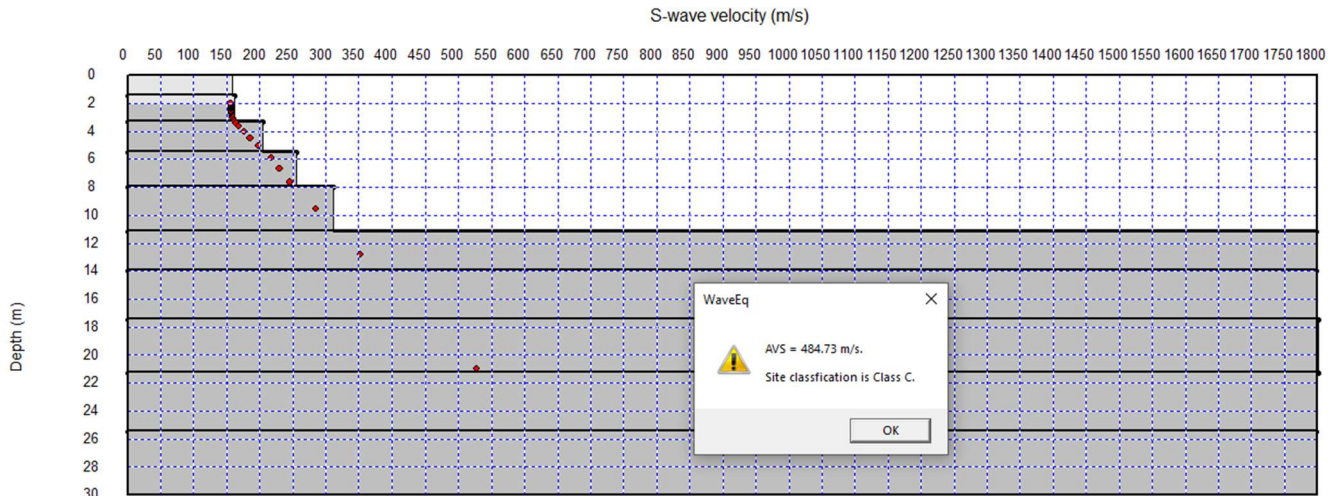

Figure 10: Shear-Wave Model under Line 3

**Option #1: Slab-on-Grade Design, 99.2m masl**

Sounding	Depth	Vs30 (m/s)	Seismic Site Class
MASW/MAM	0 to 30 meters	484	C*

\*NBC 2020 commentary “J” requirements

This site can be concluded as **Seismic Site Classification C (“Very Dense Soil and Soft Rock”)** according to the seismic site classification codes adopted by National Building Codes of Canada 2020, see Figure 11 and the International Building Code (IBC).

If we apply the NBC 2020 code and OBC 2024, there is Table 4.1.8.4.A *Exceptions for Site Designation Using Vs30 Calculated from in Situ Measurements*.  $X_v = 484$  m/s.

**Option #2: 5 metre dig depth, 94.2 masl**

Sounding	Depth	Vs30 (m/s)	Seismic Site Class
MASW/MAM	5 to 35 meters	858	B*

\*NBC 2020 commentary “J” requirements

Although the Vs30 value exceeds 760 m/s which would qualify the site as a **Seismic Site Classification B (“Rock”)** see Figure 11 there is one caveat that disqualifies this site class which is the fact there is likely more than 3 meters of rock at this location (see NBC 2020 commentary ‘J’). The use of site class “B” is conditional on the requirements of Commentary “J” sentence 100, specifically, “*Site Classes A and B, are not to be used if there is more than 3 m of soil between the rock surface and the bottom of the spread footing or mat foundation, even if the computed average shear wave velocity is greater than 760m/s*”. This rule can be disregarded if there are piles to the top of the rock.



If there will be less than 3 m of soil between the bedrock and mat foundation, site class “B” will apply.

**Option #2: 10 metre dig depth, Slab-on-Bedrock, 89 masl**

Sounding	Depth	Vs30 (m/s)	Seismic Site Class
MASW/MAM	11 to 41 meters	1800	A*

\*NBC 2020 commentary “J” requirements

If the foundation will be directly on bedrock, this site can be concluded as **Seismic Site Classification A (“Hard Rock”)** according to the seismic site classification codes adopted by National Building Codes of Canada 2020, see Figure 11, and the International Building Code (IBC).

If we apply the NBC 2020 code and OBC 2024, there is Table 4.1.8.4.A *Exceptions for Site Designation Using Vs30 Calculated from in Situ Measurements*.  $X_v = 1800$  m/s.

The use of site class “A” is conditional on the requirements of Commentary “J” sentence 100, specifically, “*Site Classes A and B, are not to be used if there is more than 3 m of soil between the rock surface and the bottom of the spread footing or mat foundation, even if the computed average shear wave velocity is greater than 760m/s*”. This rule can be disregarded if there are piles to the top of the rock.

**Seismic Site Classification ( $V_s^{30-m}$  or  $V_s^{100-ft}$ )**

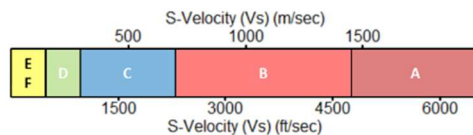

NBCC\* Seismic site classification based on shear-velocity ( $V_s$ ) ranges.

Site Class	S-Velocity ( $V_s$ ) (ft/sec)	S-Velocity ( $V_s$ ) (m/sec)
<b>A</b> (Hard Rock)	> 5,000	> 1500
<b>B</b> (Rock)	2,500 – 5000	760 – 1500
<b>C</b> (Very Dense Soil and Soft Rock)	1,200 – 2,500	360 – 760
<b>D</b> (Stiff Soil)	600 – 1,200	180 – 360
<b>E</b> (Soft Clay Soil)	< 600	< 180
<b>F</b> (Soils Requiring Add'l Response)	< 600, and meeting some additional conditions.	< 180, and meeting some additional conditions.

\* National Building Code of Canada

Figure 11: Summary of Site Class based upon Shear-wave velocities.



### Calculation of Elastic Moduli

The elastic moduli are calculated based on the velocities measured from the seismic test along with the density data. Soil density values were based on an assumed value of 1.95 g/cm<sup>3</sup>. Bedrock densities range from 2.1 to 2.6 g/cm<sup>3</sup>. An average density of 2.4 was used for the moduli calculations.

The following equations allow the calculation of the elastic moduli:

$$\text{Poisson's Ratio: } \sigma = \frac{(V_P^2 - 2V_S^2)}{2(V_P^2 - V_S^2)}$$

$$\text{Shear Modulus: } G = \frac{\rho V_S^2}{1000}$$

$$\text{Young's Modulus: } E = \frac{2\rho V_S^2(1 + \sigma)}{1000}$$

$$\text{Bulk Modulus: } K = \frac{E}{3(1 - 2\sigma)}$$

Where V<sub>s</sub> = shear wave velocity (m/s)

V<sub>p</sub> = compressional wave velocity (m/s)

ρ = density of the material (g/cm<sup>3</sup>)

Results of the elastic moduli calculation are summarized in the table below.

Layer	Depth Interval	P-wave Velocity	S-wave Velocity	Density (assumed)	Shear Modulus	Poisson's Ratio	Young's Modulus	Bulk Modulus
	(m)	(m/s)	(m/s)	(g/cm <sup>3</sup> )	(Mpa)		(Mpa)	(Mpa)
Dry Overburden - Silty Clay	0m - 1m	440	150	1.95	44	0.43	126	319
Saturated Soils - Silty Clay	1m - 11m	1450	200	1.95	78	0.49	232	3996
Granite	11m - 30m	6000	1800	2.40	7776	0.45	22559	76032

Table 3: Elastic Moduli Calculations from MASW Data

It is important to note that data analysis and seismic site classification described in this report is based on seismic methods only. The results of MASW sounding can be superseded by other geotechnical information such as the presence of sensitive and/or liquefiable soils, more than 3 meters of soft clays, high moisture content, etc. It is important to consider other geotechnical information prior to further investigations on site. For more details about seismic site classification, the reader is referred to section 4.1.8.4 of the National Building Code of Canada, 2020 Edition.



## Bedrock Results

All data, EM31, seismic and boreholes have been combined to produce the following Figures:

Figure 12: Bedrock Depth Plot

Figure 13: Surface Elevation Plot from LIDAR (Provided by Hatch)

Figure 14: Bedrock Elevation Plot created by subtracting the Figure 11 data set from the Figure 12 data set.

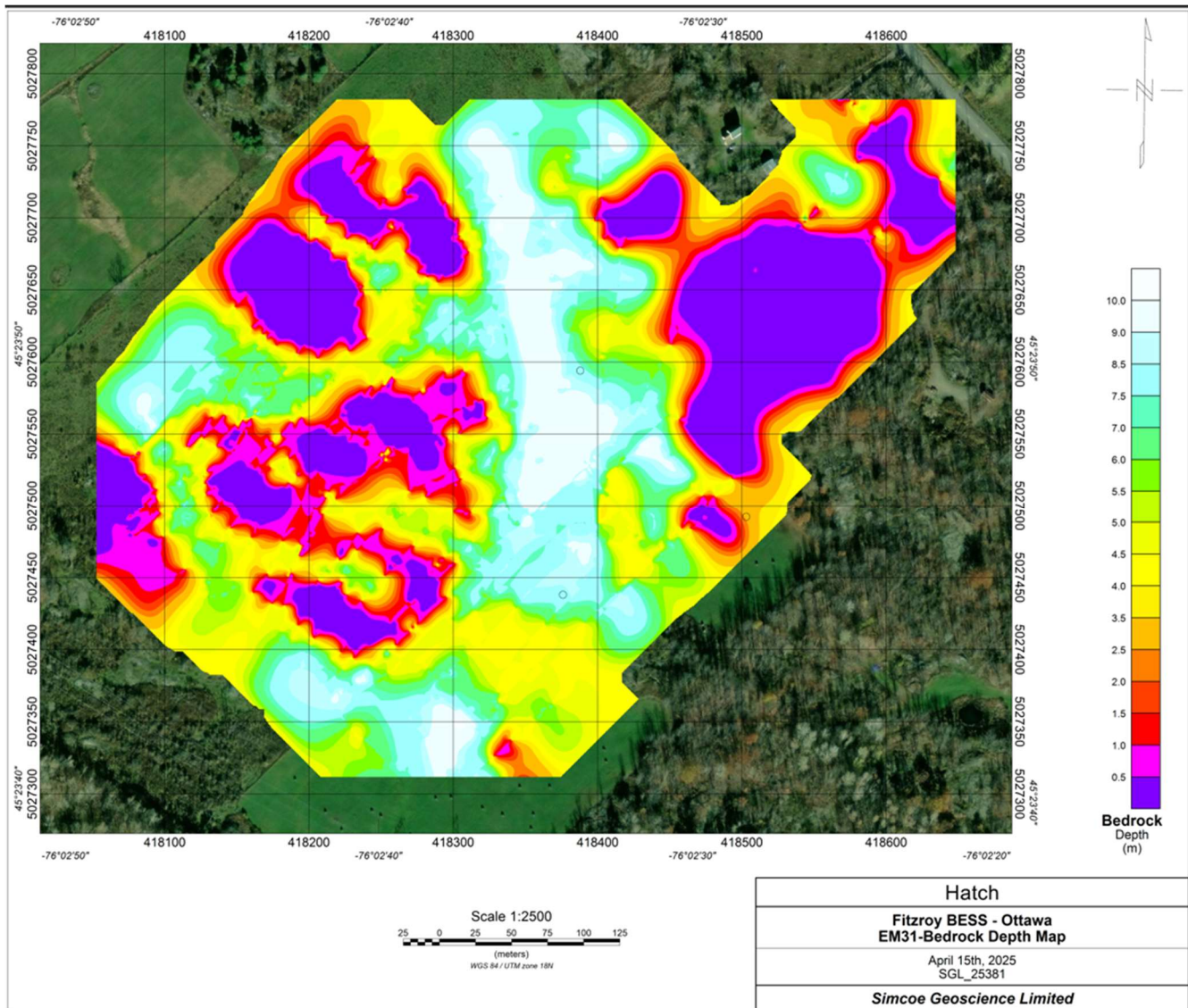

Figure 12: Bedrock Depth Plot

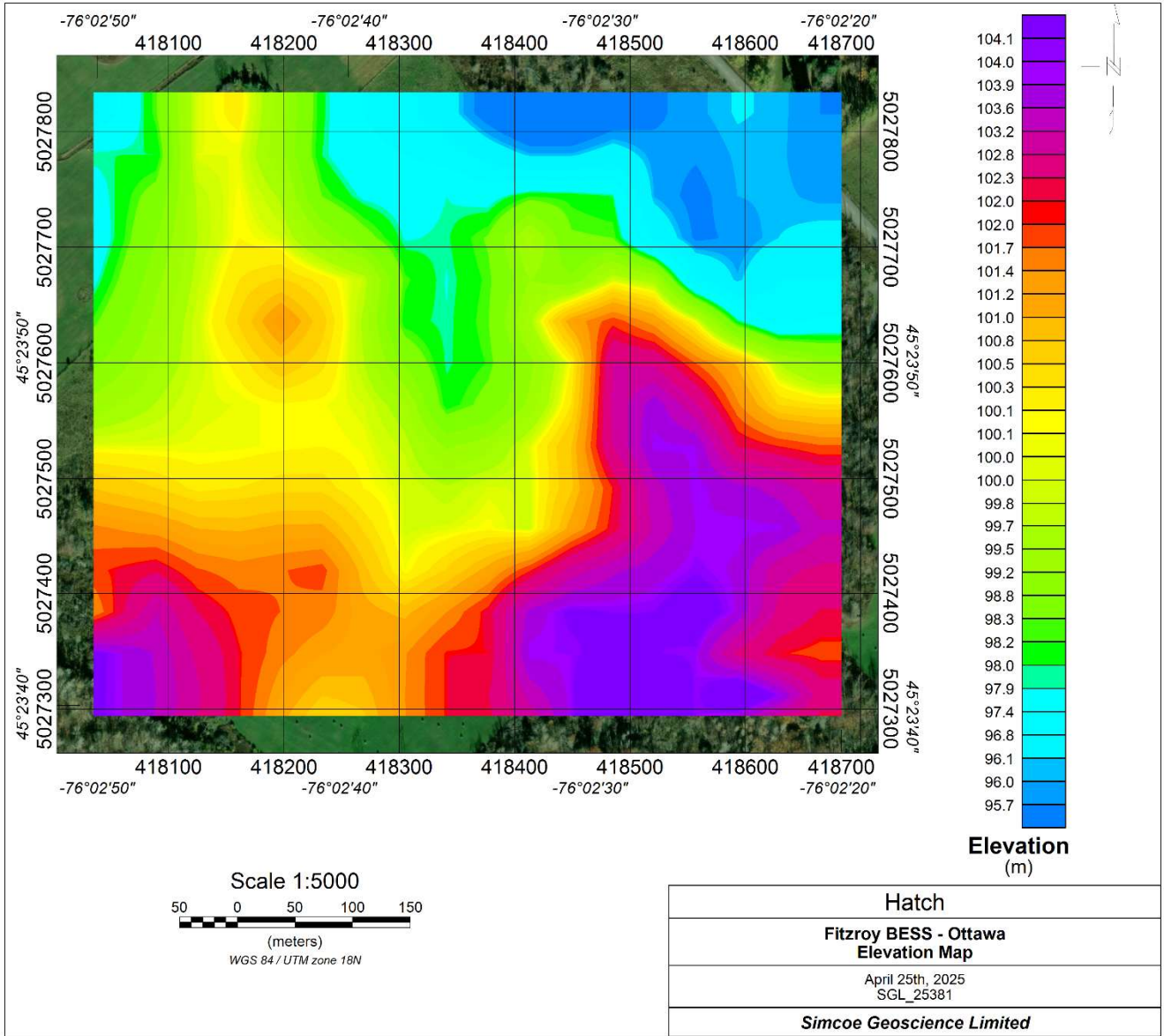

Figure 13: Surface Elevation Plot (provided by Hatch)

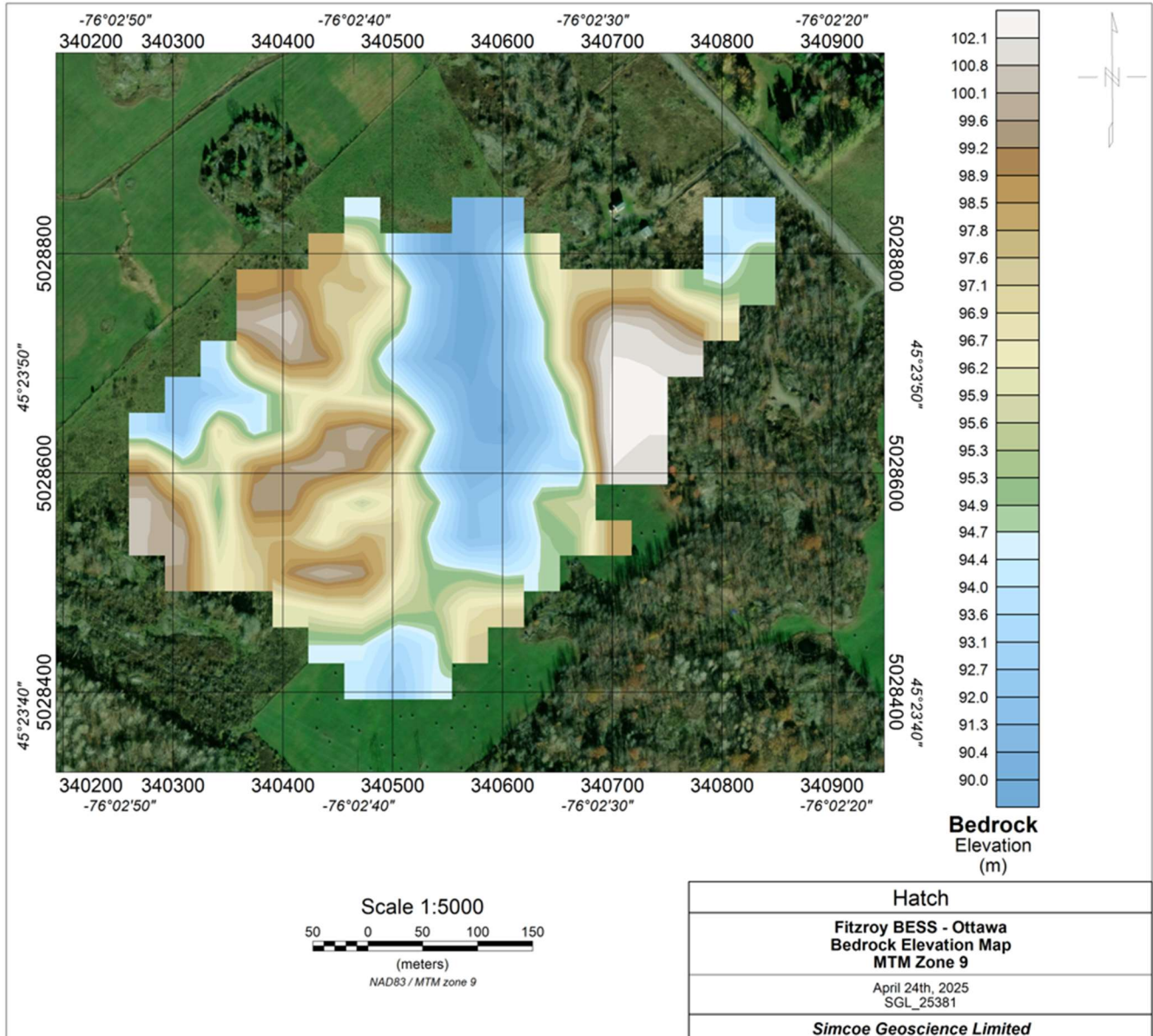

Figure 14: Bedrock Elevation Plot

We are committed to providing the next-generation ground and marine geophysical technologies and expertise to apply to all forms of engineering applications.

Respectfully submitted,

Milan Situm, P. Geo.  
Senior Geophysicist  
Simcoe Geoscience Limited





# APPENDIX A – SEISMIC REFRACTION TOMOGRAPHIC SECTIONS

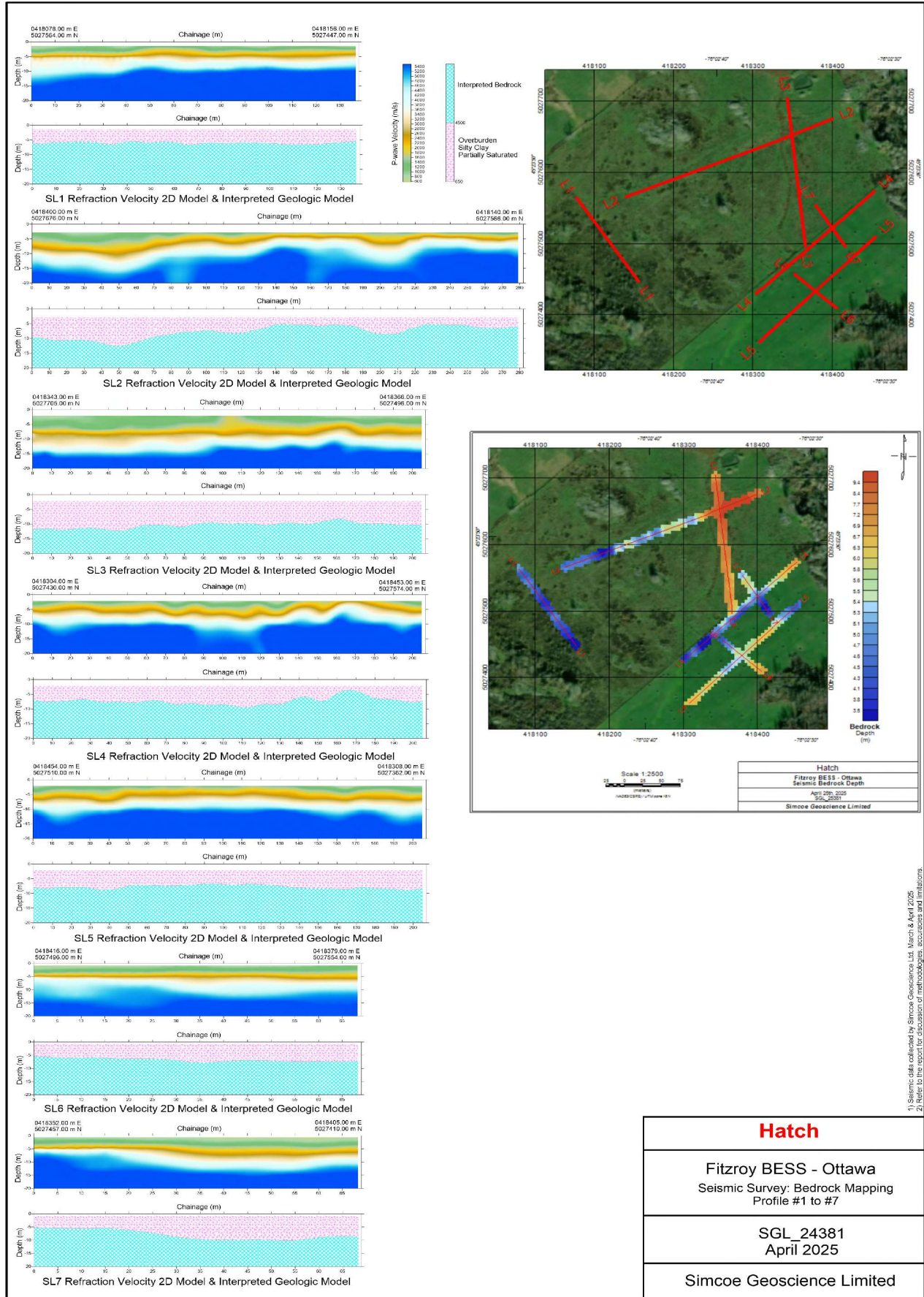

1) Seismic data collected by Simcoe Geoscience Ltd. March & April 2025.  
2) Refer to the report for discussion of methodologies, accuracies and limitations.