

## Evolugen

South March BESS

Ottawa, ON

Design Criteria

**Civil Design Criteria**

**BBA Document No.-Rev.:** 7154023-100000-41-EDC-0001-RAB

*June 19, 2025*

**FOR PERMITTING**

Do not use for construction

10 Carlson Court, Suite 420  
Toronto, ON M9W 6L2  
T +1 416.585.2115 F +1 516.585.9683  
[BBAconsultants.com](http://BBAconsultants.com)  
All rights reserved. © BBA

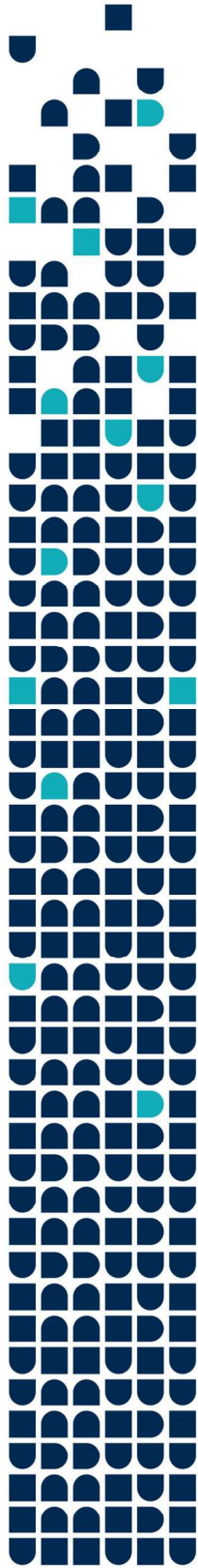

*Emmanuel Ameli*  
2025-06-19

Prepared by:  
Haoran Wu, EIT

Verified by:  
Emmanuel Ameli, P.Eng.  
PEO No. 100617996

*Mohammad Bakavoli*  
2025-06-19

Prepared by:  
Ziad Merdas, EIT

Verified by:  
Mohammad Bakavoli, P.Eng.  
EGBC No. 52936

*Greg Symons*

2025-06-19

Electrical Section Approved by:  
Greg Symons, P.Eng  
PEO No. 100557534

Approved by:  
Mina Shahraki, P.Eng  
EGBC No. 45275



## REVISION HISTORY

Revision	Document Status – Revision Description	Date
RAA	Preliminary	2025-03-26
RAB	For Permitting	2025-06-19

---



# TABLE OF CONTENTS

## Contents

- 1. General 1
  - 1.1. Scope of the design criteria ..... 1
  - 1.2. Abbreviations and acronyms..... 1
  - 1.3. Units and symbols..... 2
  - 1.4. Horizontal and vertical reference system ..... 3
- 2. Documentation ..... 3
  - 2.1. Codes, standards, and regulations ..... 3
  - 2.2. Reference documents ..... 4
  - 2.3. Conflicting documents ..... 5
- 3. General criteria..... 5
  - 3.1. Site location..... 5
  - 3.2. Climatic conditions..... 5
  - 3.3. Topographical, geotechnical, and geological data ..... 5
  - 3.4. Groundwater..... 6
- 4. Site development ..... 7
  - 4.1. Site clearing and topsoil removal ..... 7
  - 4.2. Impervious geomembrane..... 7
  - 4.3. Excavation and backfill ..... 7
  - 4.4. Grading..... 8
  - 4.5. Frost depth..... 8
  - 4.6. Roads and traffic areas ..... 8
    - 4.6.1. Design vehicles ..... 9
    - 4.6.2. Road and traffic area geometry ..... 9
    - 4.6.3. Fences and gates..... 10
- 5. Stormwater Management..... 10
  - 5.1. General and regulatory requirements ..... 10
  - 5.2. Watershed and sub-watershed definition ..... 10
  - 5.3. Design rainfall ..... 11
  - 5.4. Computer modeling..... 11
    - 5.4.1. Synthetic design storms..... 11



---

5.4.2.	Model parameters .....	11
5.4.3.	Peak flow calculation .....	12
5.4.4.	Time of concentration .....	13
5.5.	Wet pond design .....	13
5.5.1.	Quality control .....	13
5.5.2.	Erosion control.....	14
5.5.3.	Quantity control.....	14
5.5.4.	Settling calculations .....	14
5.5.5.	Dispersion length .....	14
5.5.6.	Bottom width.....	15
5.5.7.	Wet pond geometry .....	15
5.6.	Culverts .....	16
5.7.	Swales.....	17
6.	Storm sewer .....	17
6.1.	Pipe sizing and strength .....	17
6.2.	Pipe hydraulic capacity .....	18
6.3.	Manholes .....	18
6.4.	Catch basins .....	18
6.5.	Oil-water separator or Equivalent.....	19
7.	Fire water distribution .....	19
7.1.	Pipe hydraulic capacity .....	19
7.2.	Head loss calculation .....	20
7.3.	Fire hydrant.....	20
7.4.	Restraint systems .....	21
8.	Electrical Utility Connection .....	21
8.1.	Station Service LDC Connection .....	22
8.2.	Battery Backup Power Supply .....	23
8.3.	Emergency Diesel Generator.....	23



## LIST OF TABLES

Table 1: Abbreviations and acronyms.....	1
Table 2: Units and symbols .....	2
Table 3: Codes, standards and regulations .....	3
Table 4: Reference documents.....	4
Table 5: Excavation and embankment slopes .....	8
Table 6: Design vehicle.....	9
Table 7: Road/traffic area geometry .....	10
Table 8: Curve number .....	12
Table 9: Manning coefficients .....	12
Table 10: Geometry of wet ponds* .....	15
Table 11: Riprap and maximum flow velocity .....	16
Table 12: Minimum spacing between culverts.....	17

## LIST OF FIGURES

Figure 1 - SST Connected Through the MV Switchgear.....	22
---	----

## APPENDICES

- Appendix A: IDF Curves
- Appendix B: Geotechnical report



## 1. General

The South March Battery Energy Storage System (BESS) project is defined to meet Ontario's growing electricity expenditure and demand by constructing an energy storage facility. The facility will increase renewable grid capacity and storage in addition to providing a low-carbon initiative to avoid greenhouse gas emissions by reducing reliance on higher carbon-intensive facilities.

The South March BESS project is a proposed installation of a 250 MW Battery Energy Storage System. The project site is located on 2555 and 2625 Marchurst Road, Ottawa, Ontario and within the Mississippi Valley Conservation Authority.

### 1.1. Scope of the design criteria

The purpose of this document is to provide basic design requirements for the preparation of civil infrastructure deliverables for the South March BESS project.

### 1.2. Abbreviations and acronyms

The table below lists all abbreviations and acronyms used in this document, along with their definition.

**Table 1: Abbreviations and acronyms**

Abbreviation or acronym	Definition
ASTM	American Society for Testing Materials
AHJ	Authority having jurisdiction
CSA	Canadian Standards Association
MVCA	Mississippi Valley Conservation Authority
IDF	Intensity Duration Frequency
MECP	Ministry of the Environment, Conservation and Parks
MTO	Ministry of Transportation Ontario
NFPA	National Fire Protection Association
OPS	Ontario Provincial Standards
OHSA	Occupational Health and Safety Act
PEO	Professional Engineers Ontario
PSW	Provincially Significant Wetland



Abbreviation or acronym	Definition
SWMP	Stormwater Management Plan
TSS	Total Suspended Solids
US EPA	United States Environmental Protection Agency
USDA	United States Department of Agriculture
TAC	Transportation Association of Canada

### 1.3. Units and symbols

All units of measurement must be in accordance with the International Systems of Units (SI). If exceptions need to be taken, SI shall be used as the primary dimensions, with the corresponding conversion to the other system of units in brackets.

All units used in this document are listed in the following table:

**Table 2: Units and symbols**

Unit / Symbol	Description
km	Kilometer
m	Meter
cm	Centimeter
mm	Millimeter
km/h	Kilometer per hour
m <sup>3</sup>	Cubic meter
L	Liters
km <sup>2</sup>	Square kilometer
ha	Hectare
kN	Kilo Newton
kPa	Kilopascal
pers	Person
s	Second
min	Minute
h	Hour
pers	Person



## 1.4. Horizontal and vertical reference system

The project falls under the reference system NAD83 MTM Zone 9 projection.

## 2. Documentation

Unless otherwise specified, the design will be based on applicable sections of the following codes, standards, regulations, and other reference documents.

### 2.1. Codes, standards, and regulations

Table 3: Codes, standards and regulations

Document code/Author	Document title
AWWA	American Waterworks Association
CAN/CGSB	Canadian General Standards Board
City of Ottawa	Official Plan (November 2022)
City of Ottawa	Ottawa Sewer Design Guidelines, SDG002 (October 2012)
City of Ottawa	Sewer Use Bylaw (Bylaw No. 2003-514) (January 2004)
City of Ottawa	Technical Bulletin ISDTB-2014-01, Revisions to Ottawa Design Guidelines – Sewer (February 2014)
City of Ottawa	Technical Bulletin PIEDTB-2016-01, Revisions to Ottawa Design Guidelines – Sewer (September 2016)
City of Ottawa	Technical Bulletin ISDTB-2018-01, Revisions to Ottawa Design Guidelines – Sewer (March 2018)
City of Ottawa	Technical Bulletin ISDTB-2018-04, Revisions to Ottawa Design Guidelines – Sewer (June 2018)
City of Ottawa	Technical Bulletin ISDTB-2019-02, Revisions to Ottawa Design Guidelines – Sewer (July 2019)
CSA	Erosion and sediment control installation and maintenance, W208:20
EPA/Government of Ontario	Environmental Protection Act, R.S.O. 1990, c. E.19
IEEE 980	Guide for Containment and Control of Oil Spills in Substations
OPS	Ontario Provincial Standards
Ontario MOE	Stormwater Management Planning and Design Manual (March 2003)
Ontario MOE	Design Guidelines for Sewage Works (2008)
Ontario MTO	Drainage Management Manual (1995-1997)



Document code/Author	Document title
Ontario MTO	MTO Hydrotechnical Design Charts (2023)
Ontario MTO	Drainage Design Standards (2008)
Province of Ontario	Conservation Authorities Act – Ontario Regulation 41/24
CSA	MTO Highway Drainage Design Standards (January 2008)
NFPA 24	Standard for the Installation of Private Fire Service Mains and Their Appurtenances
OHSA/ USC	Occupational Health and Safety Act
Mississippi Valley Conservation Authority (MVCA)	MVCA Regulation Policies (April 2024)
TAC	Geometric Design Guide for Canadian Roads
US EPA	Storm Water Management Model User's Manual Version 5.1 (September 2015)
USDA	Urban Hydrology for Small Watersheds TR-55 (June 1986)

## 2.2. Reference documents

**Table 4: Reference documents**

Document code/Author	Document title
Tulloch Geomatics inc.	Topographic Plan of Survey of Part of the East ½ Lot 25 And Part of The Southeast ½ Lot 26 Concession 1 Geographic Township of March, City of Ottawa (File: 241451), dated: March 11 <sup>th</sup> , 2025
Hatch Ltd.	South March Road Battery Energy Storage System (BESS) Preliminary Geotechnical Investigation (H375142-0000-2A0-230-0001, Rev.A), Dated: February 28 <sup>th</sup> , 2025
Hatch Ltd.	Brookfield Renewable Energy Partners South March BESS Site Geotechnical Investigation - Hydrogeological and Terrain Analysis Study (H375142-0000-2A4-030-0001, Rev. A), Dated: March 3 <sup>rd</sup> , 2025
Hatch Ltd.	South March Battery Energy Storage System (BESS) Fluvial Geomorphology Assessment (H375142-0000-2B0-066-0001), Dated: June 4, 2025



## 2.3. Conflicting documents

Where there is a discrepancy in requirements between the codes, standards, and regulations, the references, or this document, the most stringent requirements of the conflicting documents always apply.

## 3. General criteria

The BESS and substation portions of the South March BESS project are approximately 5.3 ha of two properties totalling 84.5 ha. The proposed development consists of the BESS area, substation, stormwater pond, and access road. The substation and wet pond are located on the south and north ends of the site, respectively. Access to the site is provided via road from Marchurst Road.

The BESS site runoff is planned to drain north to a proposed stormwater pond. The project site is located within the Ottawa River Watershed. The watercourse that runs through the site will be redirected through a series of ditches and a culvert to exit the developed area and realign itself with its original route. No municipal drains are present within the site. The nearby Old Carp Road, located south of the site, is identified as a Scenic Route as per Schedule C13 of the "Official Plan" (City of Ottawa, 2022). The proposed development must meet the requirements of Section 4.6.2 policy 4 of the "Official Plan" as it is adjacent to the Scenic Route. This project follows the policy by having the site located away from Old Carp Road and remain hidden by existing trees.

### 3.1. Site location

The South March BESS project site is located at 2625 & 2555 Marchurst Road, Ottawa, Ontario.

### 3.2. Climatic conditions

The climate in the Greater Ottawa Region averages between -14 °C to 27 °C and is rarely below -23 °C or above 30 °C. See Appendix A for the IDF curves used for this project.

### 3.3. Topographical, geotechnical, and geological data

Based on the survey data completed by Tulloch Geomatics Inc., March 5, 2025, the site is relatively flat with an elevation change of approximately 99 to 104 masl across the site.



Geotechnical Site Investigation by Hatch in 2024 were not conducted in the north-west side of the BESS layout. According to the drilled boreholes, the following stratigraphical layers were encountered on site and are listed from top to bottom as follows:

1. Topsoil: A 100mm to 600mm thick layer of topsoil was encountered throughout the site.
2. Native Silty Sand:
  - This layer was encountered below the topsoil layer and Silty Clay layer discussed below and ranged in thickness between 300mm and 1.1m.
  - Based on SPT "N" blow counts ranging between 2 to 13 blows per 300mm of penetration, this layer can be classified as very loose to compact.
3. Native Silty Clay:
  - This layer was encountered below the Silty Sand layer and had a thickness range of 200mm to 4.8m throughout the site.
  - Layer consisted of a Sandy Silt with Gravel with SPT "N" blow counts ranging between 2 and 29 per 300mm of penetration in the upper 2-3m, indicating a firm to stiff compactness and becoming softer with depth.
  - Field vane tests indicated peak undrained shear strengths between 55 kPa to >96 kPa with remoulded values ranging between 6 to 8 kPa.
4. Native Silty Clay (Glacial Till):
  - This layer was encountered in one borehole at a depth of 3.0 mbgs and extended to terminus of borehole at approximately 3.6 mbgs where refusal on inferred bedrock was encountered.
  - Layer consisted of a Sandy Silt with Gravel with SPT "N" blow counts of 28 per 300mm of penetration indicating a very stiff compactness.
5. Bedrock: Rock coring was completed in one borehole between 6.1 and 9.1 mbgs. Rock encountered on site is classified as fresh and extremely strong Granitic Gneiss bedrock.

### 3.4. Groundwater

The groundwater level was measured manually during the Geotechnical Site Investigation completed by Hatch in 2024 and was found to range between 1.0 to 1.3m below the existing ground surface.



## 4. Site development

Site development refers to construction work related to infrastructures supporting the project facilities.

### 4.1. Site clearing and topsoil removal

Site clearing is carried out to the road's right-of-way or to a minimum of 10 m from circulation areas, ditches, and laydown areas in order for snowbanks not to impede on the utilized areas. Topsoil with a thickness of 100 to 600 mm will be removed from the development area (refer to geotechnical report for additional information).

### 4.2. Impervious geomembrane

To protect the groundwater from any potential contamination from the batteries, an impervious geomembrane layer will be installed across the entire site (except the substation area).

### 4.3. Excavation and backfill

In-situ soils can be reused as backfill material (refer to recommendations in the geotechnical report) and must be prioritized to borrow materials should they be free from cobbles, boulders, topsoil, organic matter, or other deleterious materials. Oversized materials (i.e., >150mm in size) should be removed.

Imported materials used for Engineered Fill should be approved by the Geotechnical Engineer, at its source, prior to importing the material to the site. Suitable soils, free of topsoil, organic matter or other deleterious materials, can be used as Engineered Fill provided that the water content of the soil at the time of placement is within  $\pm 2\%$  the materials' optimum water content for compaction. Otherwise, soils may require treatment (i.e., drying or wetting) prior to placement.

Excavation and embankment maximum slopes are presented in Table 5 and must comply with OSHA regulations. Ratios indicated in Table 5 are for material take-off calculation only. Slopes shall be inspected by an experienced Geotechnical Engineer.



**Table 5: Excavation and embankment slopes**

Location	Slope (ratio H:V)
Permanent excavations in in-situ soils	2:1
Permanent excavations in compacted fill or structural fill	2:1
Permanent embankments (compacted)	2:1
Temporary excavation in native firm to stiff silty clay (upper 2 – 3m)	1:1
Temporary excavation in native very soft to soft silty clay (>3m depth)	3:1

Deep excavations and side slopes should be reviewed by a Geotechnical Engineer.

## 4.4. Grading

For electrical substations, the following criteria are used:

- Final grade shall present a minimum slope of 0.5% on a flat terrain;
- Equipment base shall be 300±50 mm higher than final grade;
- Free-draining aggregate shall be 5-20 mm with a minimum thickness of 155 mm.

## 4.5. Frost depth

The maximum frost penetration depth is 1.8m, per the geotechnical report.

For buried pipes, frost depth will be determined based on the fill material used, the pipe manufacturer recommendation, and Geotechnical Engineer recommendations. The freezing index for the area is between 1000 °C-day and 1500 °C-day.

## 4.6. Roads and traffic areas

Access roads pavement structure preparation and installation should be completed in accordance with the geotechnical recommendations and under the supervision and approval of the Geotechnical Engineer. The pavement structure should consist of the following:

- A. Silty Clay / Silty Clay (Till-Like) Subgrade:
  - 300mm thick layer of Granular A base course compaction to 100% SPMDD; and,



- 300mm thick layer of Granular B Type II subbase course compacted to 98% SPMDD.
- Geotextile fabric and geogrid reinforcement are required.

**B. Granitic Gneiss Bedrock Subgrade:**

- 250mm thick layer of Granular A base course compaction to 100% SPMDD; and,
- 250mm thick layer of Granular B Type II subbase course compacted to 98% SPMDD.
- Geotextile fabric and geogrid reinforcement are not required.

Pavement structure materials should be compacted in 200mm loose lifts and should be within  $\pm 2\%$  of the material's optimum moisture content. Where geotextile fabric is placed, the layers should be overlapped a minimum of 450mm.

Final roadway surfaces shall be sloped at 2% or greater to promote runoff. The subgrade should be crowned at the centerline and sloped between 3% and 5% towards the roadway perimeter.

### 4.6.1. Design vehicles

Road, and traffic areas installed under these areas are designed according to loads transferred to the pavement with the following vehicles:

**Table 6: Design vehicle**

Road type/Area	Vehicle
Main access road and substation area	A lowboy semi-trailer tractor truck, Liebherr LR 1300.1 SX Crawler Crane, and fire/emergency vehicles.
Main access road and BESS area	A Tridem Drive Tractor Semi-trailer delivery truck, Liebherr LR 1300.1 SX Crawler Crane, and fire/emergency vehicles.

### 4.6.2. Road and traffic area geometry

Roads and traffic areas are designed using the following criteria.



Table 7: Road/traffic area geometry

Road type <sup>(1)</sup>	Design speed (km/h)	Maximum speed posted (km/h)	Max. vertical slope (%)	Curve radius (m) <sup>(5)</sup>	Width (m) <sup>(2) (4)</sup>
Main access road	25	20	10	14	8
BESS area roads	10	10	10	14	8
Sub-station area	10	10	10	14	8

### 4.6.3. Fences and gates

Fences shall be installed at a minimum of 1 m from the property line. Install at least one access gate per fenced area.

For electrical substations, the fence shall be located at 1.5 m from the edge of the granular platform. Fence details can be found in BBA drawing 7154023-100000-41-D90-0001 for typical details.

## 5. Stormwater Management

### 5.1. General and regulatory requirements

In Ottawa, the stormwater management design criteria are based on the guidelines outlined in the Ministry of the Environment, Conservation and Parks (MECP), formerly the Ministry of Environment (MOE) "Stormwater Management Planning and Design Manual" (MOE, 2003), and Ottawa Sewer Design Guidelines Second Edition, October 2012 and the technical bulletins: ISDTB-2014-01, PIEDTB-2016-01, ISDTB-2018-01, ISDTB-2018-04, and ISDTB-2019-02.

In addition, for the Mississippi Valley Conservation Authority (MVCA), the design of stormwater management infrastructures must comply with MVCA Regulation Policies (MVCA, 2024) prescribing the setbacks of infrastructure from watercourses, regulated wetlands, and 100-yr floodplains.

### 5.2. Watershed and sub-watershed definition

Watersheds and sub-watersheds are defined using the GIS map provided by the Mississippi Valley Conservation Authority.



### 5.3. Design rainfall

All drainage systems are designed according to a different rainfall event calculated from computed rainfall data for the project-specific location. Rain data is given the Ontario Ministry of Transportation's IDF Curve Look-up website. Drainage systems must be designed according to the risk impact on-site operations and workers safety.

Precipitation data used in this project are from 2520 Old Second Line Road located approximately 2 km east of the site. The data is extrapolated from nearby stations with an average record length of 30 years and is presented in Appendix A.

In addition, the Ottawa Sewer Design Guidelines require that rainfall intensity be stress tested using design storms increased by 20% for rainfall events to consider impacts of climatic changes. Modifications to the drainage system would be required only if severe flooding is identified by the stress test.

### 5.4. Computer modeling

PCSWMM software was used to model the existing (pre-development) and proposed stormwater management system for this project. Stormwater management systems are modeled using PCSWMM software to help size ditches, culverts stormwater pipes and detention structure.

#### 5.4.1. Synthetic design storms

Temporal distribution of precipitation for the City of Ottawa are mostly defined using Chicago and SCS type II synthetic storms. The synthetic storms were developed using Dstorm based on the IDF.

#### 5.4.2. Model parameters

The CN values were determined based on the Hydrogeological and Terrain Analysis Study (Hatch, 2025). The hydrologic soil group is expected to be group "BC" with a CN value of 69 and an estimated Horton infiltration rate of 9 mm/h (minimum) to 170 mm/h (maximum). The CN values are summarized below in Table 8.



Table 8: Curve number

Surface	Curve Number
Native site soils / Grass	69
Gravel	85
Concrete	98

The Manning coefficients used in this project are in Table 9.

Table 9: Manning coefficients

Surface	Manning's n
Grass and trees, short (overland flow)	0.15
Gravel (overland flow)	0.09
Concrete	0.013
Grass (open channel)	0.03
Drainage pipe, material type to be finalized (closed conduits)	0.013

### 5.4.3. Peak flow calculation

Peak flow, for a given structure, installation or area is calculated with the selected return period and related rainfall intensity.

Peak flow using the Rational Method is calculated as follows:

$$Q = 0,278 (C \times I \times A)$$

Where:

Q: Peak flow (m<sup>3</sup>/s)

C: Runoff coefficient

I: Rain intensity (mm/h)

A: Watershed surface area (km<sup>2</sup>)

Rainfall intensity is determined using the IDF (Intensity-Duration-Frequency) curves from the Ontario Ministry of Transportation's IDF Look-up tool. IDF curves are presented in Appendix A.



#### 5.4.4. Time of concentration

Time of concentration is defined as the time needed for water to flow from the most remote point in a watershed to the watershed outlet. It is calculated as follows:

$$t_c = t_e + t_f$$

$t_c$  = time of concentration (min.), minimum 10 minutes

$t_e$  = inlet time for surface flow (min)

$t_f$  = travel time in channel or sewer pipes (min)

### 5.5. Wet pond design

The design of the wet pond was developed according to the MECP document «Stormwater Management Planning and Design Manual». Ponds are designed to retain runoff volumes with five (5) components: the permanent pool, forebay, active storage (quality/erosion control storage), quantity control storage and an overflow. The pond is sized to ensure that the maximum peak flow rate from the 100-year design storm does not exceed the pre-development values for the 2 years return period storms.

#### 5.5.1. Quality control

The watershed receiving watercourse should be protected according to level of resilience to environmental perturbations. Three (3) levels of protection are given based on the long-term average removal of suspended solids: enhanced protection (80% removal), normal protection (70% removal), and basic protection (60% removal). The site requires enhanced protection according to the definition in the MOE design manual Section 3.3.1.1 as the area has soil with high permeability soils (SCS hydraulic class BC).

The water quality storage volume is calculated based on the level of protection required for the receiving waters and the impervious level of the subcatchment.

Based on the selected level of protection of 80% long-term suspended solids removal, and the requirements of Table 3.2 Water Quality Storage Requirements based on Receiving Waters of the Stormwater Management Planning and Design Manual (MOE, 2003), the storage volume ( $m^3/ha$ ) for an impervious level of 100% is 282 ( $m^3/ha$ ). Therefore, the minimum water quality storage volume to consider is 1464  $m^3$  for the drainage area.



### 5.5.2. Erosion control

Erosion control runoff peak flows and volumes are computed using 25-mm Chicago synthetic distribution for a 4-hour duration precipitation event.

### 5.5.3. Quantity control

For flood control, the maximum peak flow from a 100-yr post-development storm must not exceed the pre-development flow for a 2-yr storm. Existing and post-development rates were determined utilizing a computer simulation modeling.

Quantity control runoff peak flows and volumes are computed using Chicago and SCS synthetic distribution for a 100-year return period rainfall of 24 hours.

### 5.5.4. Settling calculations

To calculate the forebay volume and length, the settling calculations shall be used. The forebay settling length is calculated as follows:

$$Dist = \sqrt{\frac{r * Q_p}{V_s}}$$

Where:

Dist = Forebay length (m)

r = length-to-width ratio of forebay

Q<sub>p</sub> = peak flow rate from the pond during design quality storm

V<sub>s</sub> = Settling velocity (It is recommended that a value of 0.0003 m/s be used)

### 5.5.5. Dispersion length

The dispersion length is calculated as follows:

$$Dist = \frac{(8 * Q)}{d * V_f}$$

Where:



Dist = Length of dispersion (m)

Q = Inlet flowrate (m<sup>3</sup>/s)

d = depth of the permanent pool in the forebay (m)

V<sub>f</sub> = desired velocity in the forebay (m/s)

### 5.5.6. Bottom width

The total width of the forebay should provide a length-to-width ratio of 2:1

The minimum forebay deep zone width is calculated as follow:

$$Width = \frac{Dist}{8}$$

### 5.5.7. Wet pond geometry

Wet pond geometry is defined with the following parameters:

**Table 10: Geometry of wet ponds\***

Design element	Minimum criteria	Preferred criteria
Active Storage Detention	24 hrs (12 hrs if in conflict with minimum orifice size)	24 hrs
Drainage area	5 hectares	> 10 hectares
Forebay	<ul style="list-style-type: none"> <li>Minimum depth: 1 m</li> <li>Sized to ensure non-erosive velocities leaving forebay</li> <li>Maximum area: 33% of total Permanent Pool</li> </ul>	<ul style="list-style-type: none"> <li>Minimum Depth: 1.5 m</li> <li>Maximum area: 20% of total Permanent Pool</li> </ul>
Length/Width ratio	Overall: minimum 3:1 Forebay: minimum 2 :1	From 4:1 to 5:1
Permanent Pool Depth	Maximum depth: 3 m Mean depth: 1 m – 2 m	Maximum depth: 2.5 m Mean depth: 1 m – 2 m
Active Storage Depth	Max: 3 m Average: 1 to 2 m	Max: 2 m Average: 1 to 2 m
Side slopes	<ul style="list-style-type: none"> <li>5:1 for 3 m on either side of the permanent pool</li> <li>Maximum 3:1 elsewhere</li> </ul>	<ul style="list-style-type: none"> <li>7:1 near normal water level plus use of 0.3 m steps</li> <li>4:1 elsewhere</li> </ul>
Emergency weir	1-100 years storm	



Design element	Minimum criteria	Preferred criteria
Freeboard	300 mm	450 mm
Inlet pipe	<ul style="list-style-type: none"> <li>Minimum 450 mm diameter</li> <li>Prefeed pipe slope: &gt;1%</li> <li>If submerges, obvert 150 mm below expected maximum ice depth</li> </ul>	
Outlet pipe	<ul style="list-style-type: none"> <li>Minimum 450 mm diameter</li> <li>Reverse sloped pipe should have a minimum diameter of 150 mm</li> <li>Prefeed pipe slope: &gt;1%</li> <li>If an orifice plate control is used, 75 mm diameter minimum</li> </ul>	Minimum 100 mm orifice diameter
Buffer	<ul style="list-style-type: none"> <li>Minimum 7.5 m above maximum water quality/erosion control water level</li> <li>Minimum 3 m above heigh water level for quantity control</li> </ul>	
Maintenance access ramp	Provided to approval of Municipality	
*Adapted from MECP document "Stormwater Management Planning and Design Manual" Table 4.6		

## 5.6. Culverts

Culvert capacity is computed using HY-8 tool from the U.S. Department of Transportation.

Riprap is required when the culvert outlet flow velocity is greater than what is shown in Table 11.

**Table 11: Riprap and maximum flow velocity<sup>1</sup>**

Nominal Stone Size (mm)	Maximum flow velocity (m/s)
100	2.0
200	2.6
300	3.0
400	3.5
500	4.0
800	4.7
1000	5.2

From MTO document "Drainage Design Standards" - WC-3 Scour and Armouring – Section 3.3.1



Where the maximum stone size is 1.5 times the nominal stone size and 80% of stones (by mass) must have a diameter of at least 60% the nominal stone size.

Minimum culvert diameter shall be 450 mm for cleaning.

Minimum culvert cover shall be 600 mm.

Minimum spacing between culverts shall be as shown in Table 12.

Upstream and downstream inverts shall be 150 mm lower than channel waterbed.

**Table 12: Minimum spacing between culverts**

Culvert diameter	Minimum spacing between culverts (mm)
450 mm to 600 mm	450 mm
675 mm to 1800 mm	½ of pipe diameter
1950 mm to 3000 mm	900 mm

## 5.7. Swales

Swales should be constructed in areas where foundation soils are pervious. Refer to the project geotechnical report (Hatch, 2025) and the MECP document "Stormwater Management Planning and Design Manual"

## 6. Storm sewer

Underground storm sewer pipes should be installed so the crown of the pipe is below frost depth. If not possible, the pipe invert is at least located below frost depth. For shallower pipes, insulation panels must be installed.

### 6.1. Pipe sizing and strength

Minimum cover above the crown of the pipe is generally 300 mm but will be confirmed with the pipe supplier based on the material and diameter of the pipe. Backfill material should be placed in uniform layers not exceeding 300 mm in thickness.

Concrete pipe class (I to V) is calculated using the *Concrete Pipe Association's Concrete Pipe Design Manual method*.



Minimum storm sewer pipe diameter is 300 mm

For all road types, except for railroads and electrical substations, pipe class (wall thickness) is determined according to the design vehicle and excavation trench geometry.

For PVC pipes, standard pipe class is DR-35 for diameters 200 mm and above. The standard pipe class for diameters below 200 mm shall be DR-28. Pipe class shall be validated according to AWWA M23 PVC Pipe – Design and Installation and Handbook of PVC Pipe: Design and Construction published by Uni-Bell PVC Pipe Association.

For HDPE pipes, pipe compression stiffness is 320 kPa. Pipe rigidity shall be validated according to Handbook of Polyethylene Pipe published by the Plastics Pipe Institute.

## 6.2. Pipe hydraulic capacity

Pipes are sized to a maximum of 75% of their hydraulic capacity with the computed peak flow.

Pipe capacity is calculated with the PCSWMM software. For more information about the modeling of the existing condition (pre-development) and the proposed stormwater management system, refer to the Stormwater Management Report (7154023-100000-41-ERA-0001).

Pipe are sized for flow velocity greater than 0.75 m/s and less than 5 m/s when at capacity.

Minimum slope is 0.3% and must comply with the permissible velocities mentioned above.

## 6.3. Manholes

Manholes are located at every change in direction of the sewer line, at the junction of 2 systems, when pipe diameter changes and at every 120 m linear for pipes with a diameter less than 900 mm. For pipes 900 mm in diameter or greater, manhole spacing is 250 m minimum. Minimum manhole diameter is 1200 mm.

If the difference in elevation between upstream and downstream inverts is more than 600 mm, manhole must be designed as a drop structure.

## 6.4. Catch basins

Catch basins inlet capacity is 0.028 m<sup>3</sup>/s (1 ft<sup>3</sup>/s) for a 200 mm diameter pipe.



## 6.5. Oil-water separator or Equivalent

The installation of oil-water separators should be carried out in accordance with the specifications and criteria provided in the manufacturer's/designer's drawings.

## 7. Fire water distribution

The proposed development does not require any domestic water connection. However, for fire protection, an underground water tank with a capacity of 38,000 L is proposed to be placed South of the wet pond and be connected to a series of fire hydrants throughout the site. The size of the water tank has been recommended by the Fire Service Department of the City of Ottawa.

The minimum pipe size for a water line that supports a fire hydrant is 150mm. This was established from the City of Ottawa Design Guidelines (Water Distribution Guideline).

Although the water lines will be installed above the frost depth, since the water network will be dry, no insulation is required for the pipes. In accordance with the Ontario Code & Guide for Plumbing, the maximum pressure at any point in the distribution system in occupied areas outside of the public right-of-way shall not exceed 552 kPa (80 psi). In this site, the water network has been designed to provide 60 psi pressure along the pipes. Under fire condition, the materials and thrust restraint methods (have been shown on plan #7154023-100000-41-D20-0003 and described in city of Ottawa guideline) have proven to be sufficient for water lines with 150mm diameter. The proposed fire system in the BESS containers will include gas monitoring, heat sensors, alarming, and active ventilation which will be certified to the latest NFPA 855. The fire flow water demand is calculated as per FUS 1999 manual.

### 7.1. Pipe hydraulic capacity

water pipe hydraulic capacity is calculated using Hazen-Williams equation:

$$v = 0,849 C R_h^{0,63} S^{0,54}$$

Where:

v = Velocity (m/s)

C = Hazen-Williams coefficient

Rh = Hydraulic radius (m) = D/4

D = Pipe diameter (m)



S = Hydraulic gradient (m/m)

## 7.2. Head loss calculation

Minor head loss, mostly due to fittings, valves, accessories, etc., can be calculated using the following equation:

$$H = K \frac{v^2}{2g}$$

Where:

H = Head loss (m)

K = Loss coefficient (related to the fitting)

v = velocity (m/s)

g = gravitational acceleration = 9.81 m/s<sup>2</sup>

Frictional energy loss is calculated using the Darcy-Weisbach equation:

$$H = f \frac{Lv^2}{d2g}$$

Where:

H = friction loss (m)

f = Darcy friction factor

L = pipe length (m)

v = velocity (m/s)

d = pipe diameter (m)

g = gravitational acceleration = 9.81 m/s<sup>2</sup>

## 7.3. Fire hydrant

Remote hydrants shall be located throughout the BESS Site with the number and spacing determined in a manner such that all equipment requiring fire protection can be reached by hoses from at least two hydrants.

The maximum distance between hydrants is 90 m, and the maximum distance between the hydrant and the BESS unit is 60 m.



Fire hydrants are connected to the water main with a 150 mm diameter pipe, each fire hydrant shall be equipped with an isolation valve equipped with an indicating post

## 7.4. Restraint systems

Tees, elbows, caps, fire hydrants and any other accessories must be restrained with thrust blocks and/or restraint joints.

## 8. Electrical Utility Connection

The station service system will be used to power the protection and control systems, lighting, heating and auxiliary power requirements across the facility. Given that Sungrow is self-contained in terms of the auxiliary requirements for the BESS, no auxiliary supply is required for the Battery Unit.

The station service power supply for the South March Road BESS project will be supplied through the following sources. The primary source of power will be through the HV transmission system, a dedicated feed from one of the MV switchgears will supply power to the SST as illustrated in the Figure 2 below.

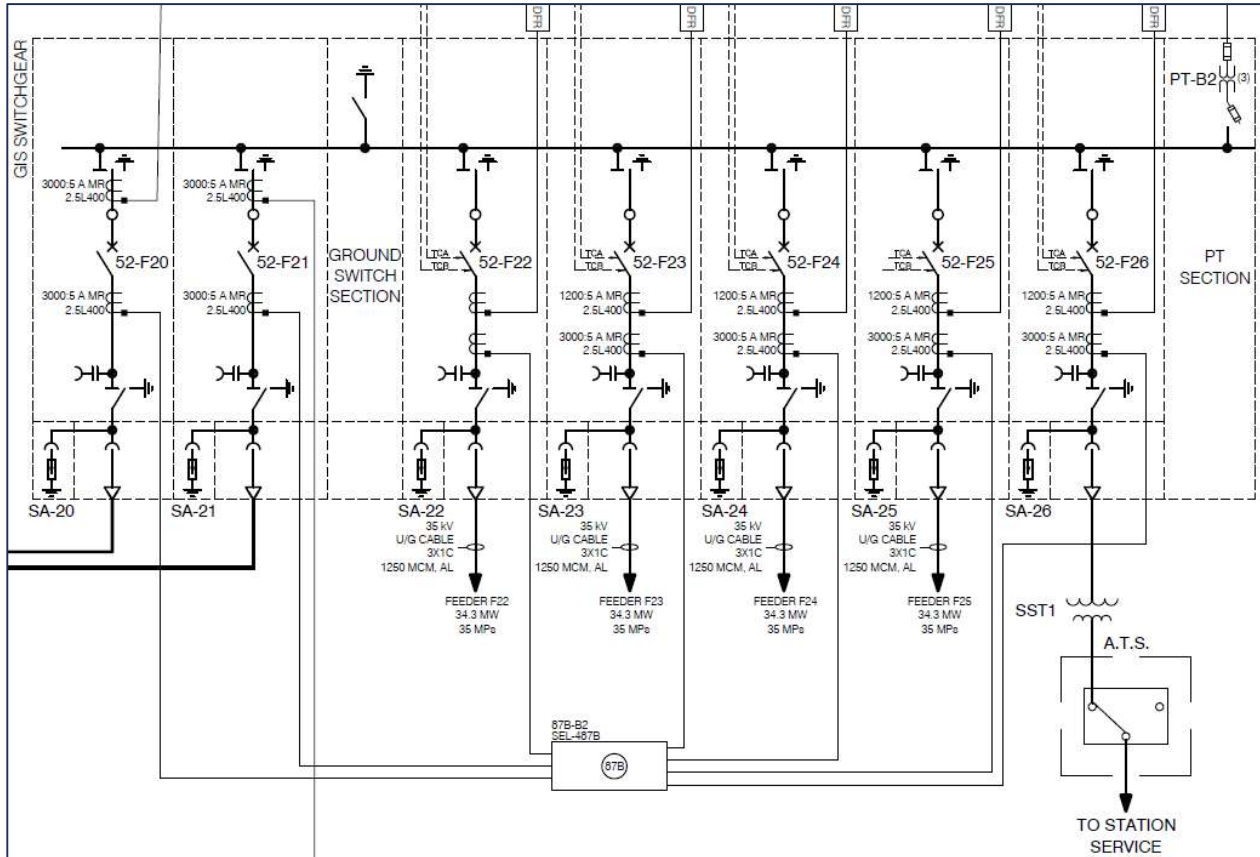

Figure 1 - SST Connected Through the MV Switchgear

The backup power supply for the station service will be supplied through a separate SST which will be connected to the LDC's distribution system. The reliability of the station service system will be further improved by using a battery system for critical protection systems and having provisions in place for an emergency diesel generator connection.

## 8.1. Station Service LDC Connection

A utility connection will need to be made to the HONI LDC's system for the purposes of station service backup power. It is expected that HONI will be providing 208/120V 300 kVA service for Tara BESS, this will be verified upon completion of load flow studies

This backup power supply will be routed underground to an ATS which would switch the power supply from the primary to backup in the event of a power loss as it is not recommended to parallel the primary and backup power supplies.



## 8.2. Battery Backup Power Supply

DC power supply will be in place for the protection, control and tele-protection equipment. These batteries will be located in close proximity to the protection racks to minimize wiring and

## 8.3. Emergency Diesel Generator

Connection provisions will be included in the station service system so that an EDG can be quickly connected. A camlock connector and fused disconnect switch will be located by the EDG pad so that a EDG can be trucked in and connected quickly during plant outages or on an as needed basis.



## Appendix A: IDF Curves

## Active coordinate

45° 24' 15" N, 76° 1' 14" W (45.404167,-76.020833)

Retrieved: Tue, 17 Dec 2024 23:57:39 GMT



### Location summary

These are the locations in the selection.

**IDF Curve:** 45° 24' 15" N, 76° 1' 14" W (45.404167,-76.020833)

### Results

An IDF curve was found.

**Coordinate: 45.404167, -76.020833**  
**IDF curve year: 2010**

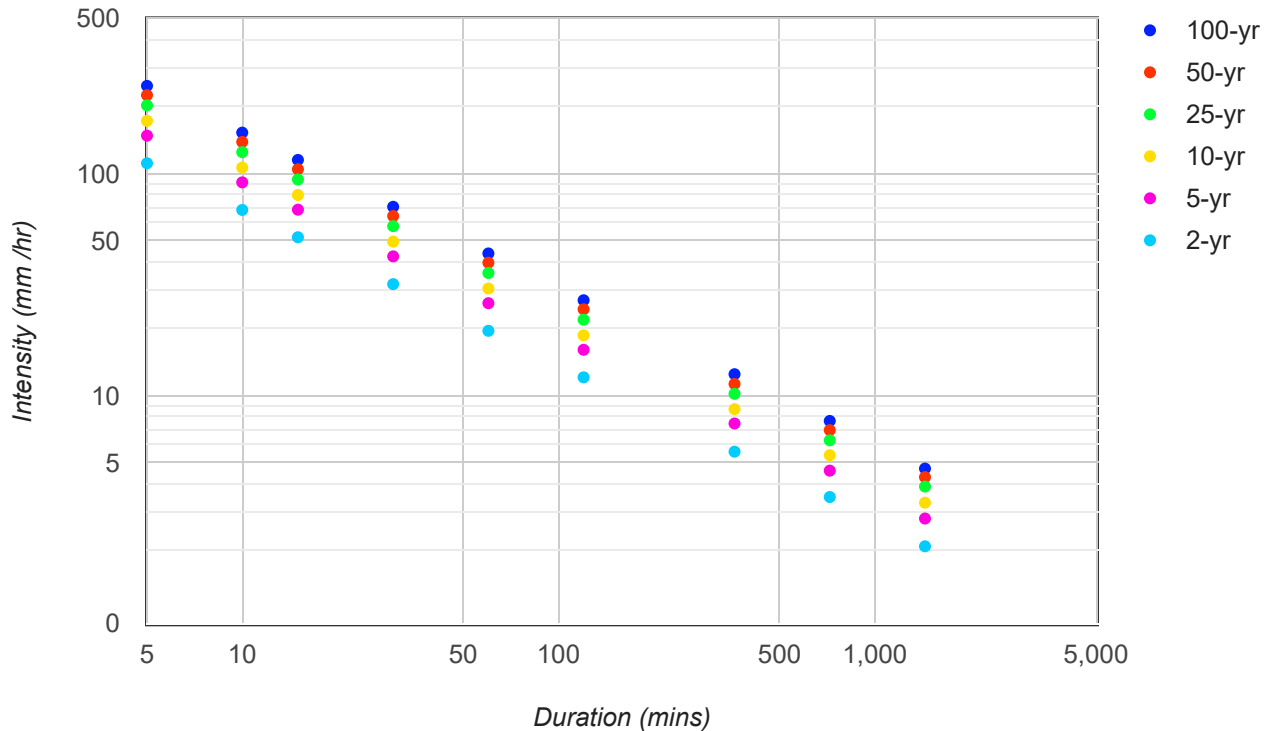

## Coefficient summary

**IDF Curve:** 45° 24' 15" N, 76° 1' 14" W (45.404167,-76.020833)

Retrieved: Tue, 17 Dec 2024 23:57:39 GMT

**Data year:** 2010

**IDF curve year:** 2010

Return period	2-yr	5-yr	10-yr	25-yr	50-yr	100-yr
<b>A</b>	19.6	26.1	30.4	35.7	39.7	43.7
<b>B</b>	-0.699	-0.699	-0.699	-0.699	-0.699	-0.699

## Statistics

### Rainfall intensity (mm hr<sup>-1</sup>)

Duration	5-min	10-min	15-min	30-min	1-hr	2-hr	6-hr	12-hr	24-hr
<b>2-yr</b>	111.3	68.6	51.7	31.8	19.6	12.1	5.6	3.5	2.1
<b>5-yr</b>	148.2	91.3	68.8	42.4	26.1	16.1	7.5	4.6	2.8
<b>10-yr</b>	172.7	106.4	80.1	49.4	30.4	18.7	8.7	5.4	3.3
<b>25-yr</b>	202.8	124.9	94.1	58.0	35.7	22.0	10.2	6.3	3.9
<b>50-yr</b>	225.5	138.9	104.6	64.4	39.7	24.5	11.3	7.0	4.3
<b>100-yr</b>	248.2	152.9	115.2	70.9	43.7	26.9	12.5	7.7	4.7

### Rainfall depth (mm)

Duration	5-min	10-min	15-min	30-min	1-hr	2-hr	6-hr	12-hr	24-hr
<b>2-yr</b>	9.3	11.4	12.9	15.9	19.6	24.1	33.6	41.4	51.0
<b>5-yr</b>	12.4	15.2	17.2	21.2	26.1	32.2	44.8	55.1	67.9
<b>10-yr</b>	14.4	17.7	20.0	24.7	30.4	37.5	52.1	64.2	79.1
<b>25-yr</b>	16.9	20.8	23.5	29.0	35.7	44.0	61.2	75.4	92.9
<b>50-yr</b>	18.8	23.2	26.2	32.2	39.7	48.9	68.1	83.9	103.3
<b>100-yr</b>	20.7	25.5	28.8	35.5	43.7	53.8	74.9	92.3	113.7

## Terms of Use

You agree to the [Terms of Use](#) of this site by reviewing, using, or interpreting these data.

[Ontario Ministry of Transportation](#) | [Terms and Conditions](#) | [About](#)

Last Modified: September 2016



## Appendix B: Geotechnical report

# South March Battery Energy Storage System (BESS) Preliminary Geotechnical Investigation

H375142-0000-2A0-230-0001

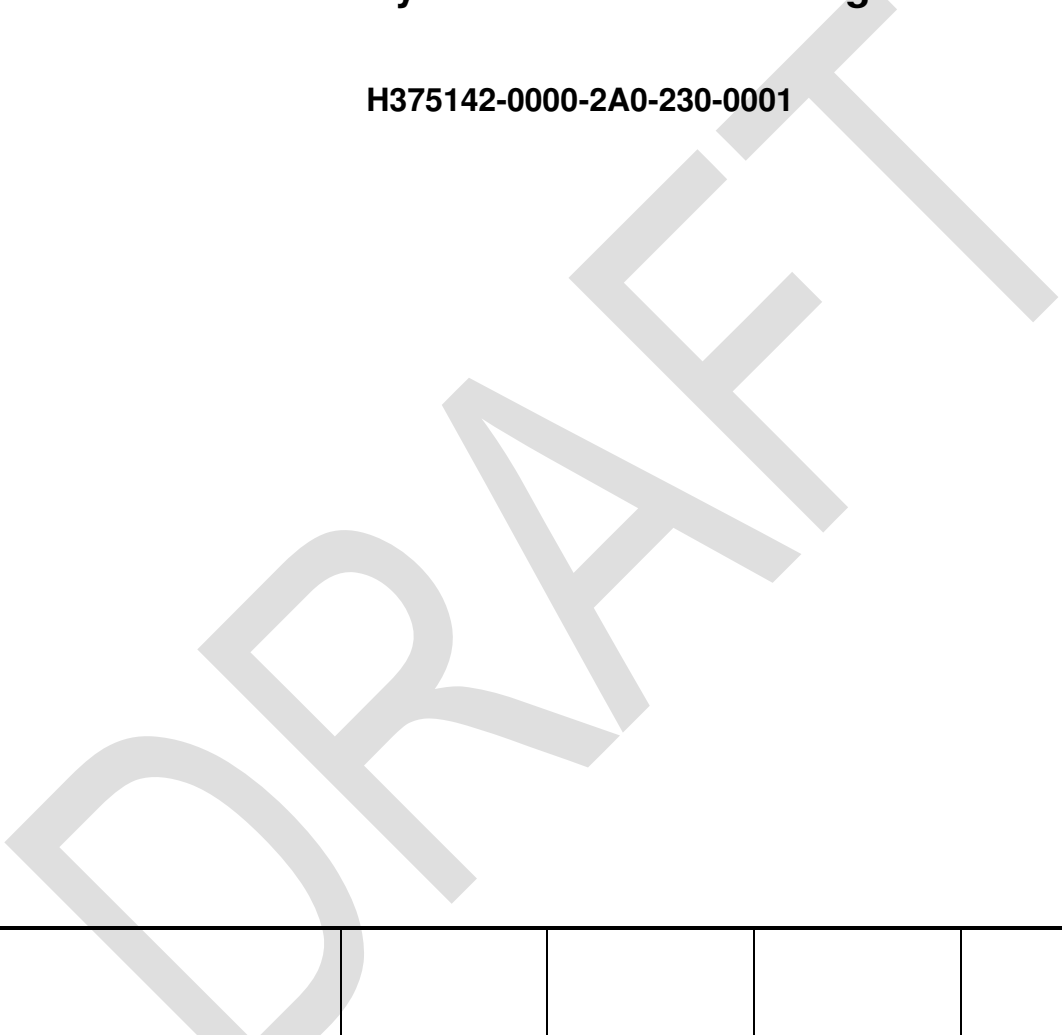

2025-02-28	A	Internal & Client Review	T. Beadle	B. Kussmann	R. Seymour	
DATE	REV.	STATUS	PREPARED BY	CHECKED BY	APPROVED BY	APPROVED BY
				Discipline Lead	Functional Manager	

## IMPORTANT NOTICE TO READER

This report was prepared by Hatch Ltd. (“**Hatch**”) for the sole and exclusive use of Brookfield Renewable (the “**Principal**”) for the purpose of the South March Battery Energy Storage System (BESS) project. This report must not be used by the Principal for any other purpose, or provided to, relied upon or used by any other person without Hatch’s prior written consent.

This report contains the expression of the opinion of Hatch using its professional judgment and reasonable care based on information available and conditions existing at the time of preparation.

The use of, or reliance upon, this report is subject to the following:

1. This report is to be read in the context of and subject to the terms of the relevant Purchase Order (PO) No. C157954 between Hatch and the Principal (the “**Hatch Agreement**”), including any methodologies, procedures, techniques, assumptions and other relevant terms or conditions specified in the Hatch agreement;
2. This report is meant to be read as a whole, and sections of the report must not be read or relied upon out of context; and
3. Unless expressly stated otherwise in this report, Hatch has not verified the accuracy, completeness or validity of any information provided to Hatch by or on behalf of the Principal and Hatch does not accept any liability in connection with such information.

## Table of Contents

<b>1. Introduction</b>	<b>1</b>
<b>2. Project and Site Description</b>	<b>1</b>
<b>3. Geotechnical Standards</b>	<b>2</b>
<b>4. Investigation Procedures</b>	<b>2</b>
4.1 Health and Safety Plan	2
4.2 Utility Service Clearances	2
4.3 Borehole Drilling, Sampling and In-Situ and Field Testing	2
4.4 Field Electrical Resistivity Testing	3
4.5 As-Drilled Borehole Locations	4
<b>5. Laboratory Testing</b>	<b>4</b>
5.1 Geotechnical Laboratory Testing	4
<b>6. Geotechnical Results</b>	<b>5</b>
6.1 Regional Geology	5
6.2 Subsurface Conditions	6
6.2.1 Topsoil	6
6.2.2 Silty Sand	7
6.2.3 Silty Clay	7
6.2.4 Silty Clay (Glacial Till)	8
6.2.5 Granitic Gneiss Bedrock	8
6.2.6 Groundwater Conditions	8
6.3 Soil Chemical Testing	9
<b>7. Geotechnical Discussion and Design Considerations</b>	<b>9</b>
7.1 Site Preparation	10
7.1.1 Subgrade Preparation	10
7.1.2 Engineered Fill Requirements	11
7.1.3 Excavations	12
<b>8. Structures</b>	<b>14</b>
8.1 Shallow Foundations	14
8.2 Slab-On-Grade	17
8.3 Deep Foundations	18
8.3.1 Drilled Pier (Caisson) Foundations	18
8.3.2 Helical (Screw) Piles	19
8.3.3 Additional Design and Construction Recommendations	21
8.4 Lateral Earth Pressures	21
8.5 Installation of Underground Services	22
8.5.1 Temporary Excavations	22

8.5.2	Pipe Bedding and Cover.....	23
8.5.3	Trench Backfill .....	23
8.6	Access Road Design .....	25
<b>9.</b>	<b>Corrosivity Analysis .....</b>	<b>26</b>
<b>10.</b>	<b>Seismic Classification for Seismic Response.....</b>	<b>26</b>

**List of Tables**

Table 4-1:	As-Drilled Borehole Identification and Depth.....	4
Table 8-1:	Founding Elevations and Geotechnical Axial Resistances .....	15
Table 8-2:	Preliminary Geotechnical Axial Resistances for Caissons.....	18
Table 8-3:	Preliminary Factored Geotechnical Axial Resistances for Helical Piles.....	20
Table 8-4:	Lateral Earth Pressure Parameters .....	22
Table 8-5:	Access Road Construction Details .....	25

**List of Figure**

Attachment:	Figure 1 .....	1
-------------	----------------	---

**List of Appendices**

<b>Appendix A</b>	<b>Record of Boreholes</b>
<b>Appendix B</b>	<b>Geotechnical Laboratory Testing</b>
<b>Appendix C</b>	<b>Advanced Geotechnical Laboratory Testing</b>
<b>Appendix D</b>	<b>Chemical Testing</b>
<b>Appendix E</b>	<b>Electrical Resistivity Testing</b>
<b>Appendix F</b>	<b>Rock Core Photographs</b>

## 1. Introduction

Hatch Ltd. (Hatch) has been retained by Brookfield BRP Canada Corporation (Brookfield) to provide geotechnical investigation services as part of the South March Battery Energy Storage System (BESS) project (Project) under Purchase Order (PO) No. C157954.

The investigation was conducted in accordance with Project Addendum No. P-079708 Appendix I – Scope and Work Plan, dated October 9, 2024. A proposed geotechnical investigation document was prepared for the South March BESS where geotechnical investigations were required and submitted to Brookfield for review and approval prior to initiation based on our understanding of the project scope. The investigation was carried out at locations selected by Hatch and approved by Brookfield at the project site.

The objective of the investigation was to characterize the soil, rock and groundwater conditions (where applicable) at the BESS site by advancing boreholes at select locations. This geotechnical investigation report presents the investigation methodology, records of boreholes and coreholes, geotechnical field and laboratory test data completed to date and geotechnical analyses and recommendations for foundation design of the South March BESS facility and ancillary structures, as well as general construction considerations. In addition, this report identifies and discusses potential geological and geotechnical hazards and their associated risks.

This report should be read in conjunction with the “Important Notice to Reader”. The reader’s attention is specifically drawn to this information, as it is essential for the proper use and interpretation of this report. If information or assumptions contained herein are incorrect, please inform Hatch so that we may amend our recommendations as appropriate.

## 2. Project and Site Description

The South March BESS project is directly responding to the Independent Electricity System Operator’s (IESO) request to increase supply and capacity to meet Ontario’s growing electricity expenditure and demand by constructing an energy storage facility. The facility will increase renewable grid capacity and storage, enhance flexible grid operations and provide a low carbon initiative to avoid greenhouse gas emissions by reducing reliance on higher carbon intensive facilities.

Based on the drawing entitled “Civil, General Arrangement, Plan, Sungrow” dated October 22, 2024, Drawing No. 7154023-100000-41-D20-00002, Brookfield is proposing to develop approximately 15 acres of 150 acres of property at 2555 and 2625 Marchurst Road in Dunrobin, Ontario, approximately 26 km southwest of Ottawa. Hatch understands the Project will consist of about 432 battery energy storage “cabinets” in about 108 “modules”, a substation, access roads and associated electrical infrastructure.

A key plan outlining the site location is shown on Figure 1 following the text of this report.

### 3. Geotechnical Standards

The geotechnical investigation, soil/rock descriptions and the graphical representations of the soil types are in general accordance with the American Society for Testing and Materials (ASTM) D2488-17. Geotechnical field, in-situ and laboratory testing was carried out in accordance with the relevant testing methods specified in the American Society for Testing and Materials (ASTM) Standards.

### 4. Investigation Procedures

#### 4.1 Health and Safety Plan

Prior to initiating the field work at the site, Hatch prepared a site-specific Health and Safety Environment Plan (HSEP) for Hatch staff and subcontractor use. The HSEP addressed health and safety within the work area and established contingency plans for emergencies that may occur during the field work.

#### 4.2 Utility Service Clearances

Underground public utility clearances were obtained through Ontario One Call prior to initiating the intrusive investigation. A private utility locator was also retained to confirm that the proposed borehole locations were clear of private underground utilities for boreholes located within private property.

#### 4.3 Borehole Drilling, Sampling and In-Situ and Field Testing

The proposed borehole locations were selected by Hatch's geotechnical staff and approved by Brookfield prior to mobilization. Hatch located the boreholes in the field using measurements relative to existing site features and a hand-held Global Positioning System (GPS) device. Detailed below, the geotechnical investigation program consisted of the following:

- Standard Penetration Test (SPT) split-spoon sampling was carried out at nine borehole locations (Boreholes FY24-1 to FY24-9);
- Rock coring was completed in one select borehole;
- One monitoring well was installed at a select location; and
- Electrical Resistivity Testing was completed along two lines.

OGS Inc. (OGS) of Almonte, Ontario, supplied and operated a track-mounted drill rig to advance the SPT boreholes/coreholes as detailed above and as shown on the Borehole Location Plan in Figure 1 following the text of this report.

The field work was observed by members of Hatch's engineering and technical staff, who located the boreholes, arranged for the clearance of underground services, observed the drilling investigation and soil sampling, photographed and recorded field observations, in-situ testing operations, logged the boreholes, and examined the soil samples.

The SPT boreholes were advanced by hollow stem augers and soil samples were taken at 0.76-m intervals within the upper approximately 4.6 m, and at 1.5-m intervals below the 4.6 m depth using 50-mm diameter split-spoon samplers, in accordance with the SPT procedure (ASTM D1586-08a: Standard Test Method for Standard Penetration Tests and Split Barrel Sampling of the Soil). Pocket penetrometer tests were carried out on the cohesive soil SPT samples once retrieved from the borehole. Thin-walled Shelby tube samples were retrieved in select soil strata, where possible, in accordance with ASTM Standard D1587, in order to complete advanced geotechnical laboratory testing on the collected samples. In-situ vane shear testing (ASTM D2573) was completed in the cohesive soils, where possible, with a 'N' sized vane.

The soil samples were described and logged in the field with respect to soil type/group and moisture content. Bedrock coring completed in one borehole was carried out using an NQ sized core barrel.

Bulk soil samples were collected in sealed 5-gallon buckets from auger cuttings at depths of approximately 0.3 m to 1.5 m below ground surface for thermal resistivity, standard Proctor and California Bearing Ratio (CBR) laboratory tests. Bulk samples on which moisture content and classification testing were performed were placed in sealed bags.

For geotechnical investigation purposes, the soil SPT, Shelby tube samples and rock cores were labelled and transported to Hatch's Niagara Falls geotechnical laboratory where the samples underwent further visual examination and laboratory testing. Bulk samples were shipped to Soil Engineering Testing, Inc., (SET) in Bloomington, Minnesota for the specified testing.

#### 4.4 Field Electrical Resistivity Testing

Field electrical resistivity testing was completed at a total of two locations. The resistivity testing was completed in accordance with ASTM method G57 "Standard Test Method for Field Measurement of Soil Resistivity Using the Wenner Four-Electrode Method" (equivalent to IEEE Std. 81). Electrode "A" spacings of 2, 5, 10, 20, 50, 100, and 200 ft were used at the test locations. At each of the locations, measurements were taken to determine average soil resistivity along the test sections.

The equipment used to collect the data consisted of a resistivity meter, four metal electrodes and connecting wire. Co-linear arrays of four electrodes were placed in the ground for each measurement. Electrical current was input to the ground through the two outer electrodes of the array. The voltage drop produced by the resulting electrical field was measured across the two inner electrodes. The "A" spacing was increased with each measurement, expanding

the array about a common center. Increasing the electrode separation increases the depth of exploration and indicates vertical variation in resistivity. The resistivity meter reported apparent resistivity; the conversion of electrical potential and inductance to apparent resistivity was not required.

## 4.5 As-Drilled Borehole Locations

The as-drilled borehole locations were surveyed using a hand-held GPS unit and the ground surface elevations were interpolated from site survey provided by Brookfield referenced to a High-Resolution Digital Elevation Model (HRDEM), dated February 2025. Borehole locations are shown on the Borehole Location Plan and referenced to NAD 83 MTM Zone 9. Elevations noted on the Record of Borehole sheets in Appendix A are referenced to Canadian Geodetic Vertical Datum 2013 (CGVD2013). A summary of the borehole locations and elevations are summarized in Table 4-1 below.

**Table 4-1: As-Drilled Borehole Identification and Depth**

Borehole Location	Borehole Type	Northing (m)	Easting (m)	Ground Surface Elevation (m)	Borehole Depth (m)	Monitoring Well Depth / Screened Interval (m)
FY24-1	SPT /NQ Rock Core	5,028,520.19	340,593.57	100.89	9.14	9.14 / 1.22 – 4.27
FY24-2	SPT	5,028,632.28	340,428.35	100.19	1.20	-
FY24-3	SPT	5,028,685.75	340,470.80	99.04	2.85	-
FY24-4	SPT	5,028,617.03	340,502.04	100.10	1.05	-
FY24-5	SPT	5,028,675.83	340,603.10	99.22	7.55	-
FY24-6	SPT	5,028,607.61	340,644.90	100.43	3.55	-
FY24-7	SPT	5,028,576.59	340,719.30	103.20	4.65	-
FY24-8	SPT	5,028,511.78	340,657.27	102.89	0.75	-
FY24-9	SPT	5,028,663.08	340,667.29	100.20	3.60	-

The as-drilled borehole locations may differ slightly from the proposed borehole locations due to site access considerations.

## 5. Laboratory Testing

### 5.1 Geotechnical Laboratory Testing

The following geotechnical testing was carried out on selected soil samples:

- Moisture Content (ASTM D2216);
- Grain Size Distribution (ASTM D6913);
- Atterberg Limits (ASTM D4318);

- Unconsolidated Undrained Triaxial Compression Tests for Cohesive Soil (ASTM D2850);
- Unconfined Compressive Strength Tests of Cohesive Soils (ASTM D2166);
- One Dimensional Soil Consolidation Test (ASTM D2435);
- Thermal Resistivity Test (ASTM D5334);
- California Bearing Ratio (ASTM D1883);
- Standard Proctor Density (ASTM D698);
- Soil pH tests in accordance (ASTM G51); and
- Soluble chloride and soluble sulfate of soils (ASTM D4327).

The geotechnical test results carried out on selected soil samples are shown on the Record of Borehole sheets presented in Appendix A. The results of the classification tests are presented in Appendix B. The advanced geotechnical laboratory testing results are presented in Appendix C.

A soil sample for thermal resistivity testing was collected at the location of Borehole FY24-1. The sample was transported to Soil Engineering Testing, Inc., (SET) in Bloomington, Minnesota for laboratory testing in accordance with ASTM D5334, "Standard Test Method for Determination of Thermal Conductivity of Soil and Soft Rock by Thermal Needle Probe Procedure". Bulk samples were recompacted to 85% of the soils maximum dry density (MDD). California Bearing Ratio (CBR), standard Proctor and grain size distribution testing were also conducted on the bulk sample recompacted to 95% MDD. The test reports are presented in Appendix C.

## 6. Geotechnical Results

### 6.1 Regional Geology

As delineated in *The Physiography of Southern Ontario*<sup>1</sup>, the South March BESS site lies within the physiographic region known as the Ottawa Valley Clay Plain. This region is characterized by relatively thick deposits of sensitive marine clay, silty clay and silt that were deposited within the Champlain Sea basin. These deposits, known as the Champlain Sea clay or Leda clay, overlie relatively thin, reworked glacial till and glaciofluvial deposits which overlie bedrock.

<sup>1</sup> Chapman, L. J. and Putnam, D. F. 1984. *The Physiography of Southern Ontario*, Ontario Geological Survey. Special Volume 2, Third Edition. Accompanied by Map P.2715, Scale 1:600,000. Ontario Ministry of Natural Resources.

West of the Carp River valley, the upper bedrock consists of limestone of the Ottawa Formation. Within and immediately east of the Carp River valley, the upper bedrock consists of sandstones and dolostones that have been cut by igneous and metamorphic rocks controlled by faulting in the vicinity of the Carp River.<sup>2</sup>

## 6.2 Subsurface Conditions

The detailed subsurface soil and rock conditions encountered in the boreholes advanced as part of the investigation and the results of the in-situ, field and laboratory testing are provided in the following appendices:

- Appendix A – Record of Boreholes;
- Appendix B – Soil Classification Testing (Grain-Size Distribution);
- Appendix C – Advanced Laboratory Testing;
- Appendix D – Chemical Testing;
- Appendix E – Electrical Resistivity Testing;
- Appendix F – Rock Core Photographs.

Classification and identification of the soils are based on the American Society of Testing and Materials (ASTM) D2488-17 – Standard Practice for Description and Identification of Soils. The stratigraphic boundaries shown on the Record of Borehole sheets are inferred from non-continuous sampling, observations of drilling progress and results of SPTs. These boundaries, therefore, represent transitions between soil types/groups rather than exact planes of geological change. Further, subsurface conditions will vary between and beyond the borehole locations.

A detailed description of the subsurface conditions encountered in the boreholes is provided in the following sections.

### 6.2.1 Topsoil

Topsoil was encountered in all boreholes advanced at the site and is 100 mm to 600 mm thick. Materials identified as topsoil in this report were classified based on visual and textural evidence and no other testing for organic content or other nutrients was carried out. Localized zones of thicker or thinner surficial soil with variable organic content should be expected across the site depending on the agricultural use and topography.

---

<sup>2</sup> Belanger, J. R. "Urban Geology of Canada's National Capital Area", in Urban Geology of Canadian Cities, Geological Association of Canada Special Paper 42, Ed. P.F. Karrow and O.L. White, 1998.

## 6.2.2 **Silty Sand**

Silty sand was encountered below the topsoil in Boreholes FY24-4 and FY24-7 at depths of 0.1 m and 0.3 m below ground surface and is 0.5 m and 0.6 m thick, respectively. Silty sand was also encountered below the silty clay deposit in Borehole FY24-1, discussed below, at a depth of 4.9 m below ground surface and is 1.1 m thick.

The measured SPT 'N' values within the silty sand ranges from 2 blows to 13 blows per 0.3 m of penetration, indicating a very loose to compact state of relative compaction.

## 6.2.3 **Silty Clay**

Silty clay was encountered below the topsoil in all boreholes advanced at the site, except Boreholes FY24-4 and FY24-7 where the silty clay was encountered below the silty sand. The silty clay was measured to be 0.2 m to 4.8 m thick in the boreholes. The silty clay contains trace sand.

The measured SPT 'N' values within the silty clay range from 2 blows to 29 blows per 0.3 m of penetration, suggesting a very soft to very stiff consistency. The measured SPT 'N' values measured in the upper about 2 m to 3 m of the silty clay generally correlated to a firm to stiff consistency with the consistency becoming softer with depth (very soft to soft).

Field vane tests conducted within Boreholes FY24-1 and FY24-5 indicated peak undrained shear strengths ranging from about 55 kPa to greater than 96 kPa (field vane would not turn) and remoulded values ranging from 6 kPa to 8 kPa. The field vane tests indicate that the silty clay has a stiff consistency with a sensitivity of 9 to 15, where tested.

The results of grain-size distribution testing conducted on two samples of the silty clay are shown in [Appendix B](#).

Atterberg limits testing conducted on eight samples of the silty clay measured liquid limits ranging from 33% to 49%, plastic limits ranging from 14% to 23% and plasticity indices ranging from 19% to 29%. The results of the Atterberg limits testing are shown plasticity charts in [Appendix B](#) and indicate that the tested samples are silty clay of low plasticity (CL).

The water content measured on samples of the silty clay range from 10% to 55%.

Unconsolidated Undrained (UU) triaxial compression testing was conducted on two samples of the silty clay. The UU testing indicated undrained shear strengths of 106 kPa in Borehole FY24-1 and 68 kPa in Borehole FY24-5.

An Unconfined Compressive Strength (UCS) test was conducted on one sample of the silty clay and the results indicated a compressive strength of 182 kPa which correlates to an undrained shear strength of 91 kPa (1/2 compressive strength).

A laboratory compaction test was conducted on the bulk soil sample and the Standard Proctor testing indicated the maximum dry density was 16.3 kN/m<sup>3</sup> with a corresponding optimum moisture of 21.6%. The results of the standard Proctor tests are provided in Appendix C.

The bulk soil sample was also compacted to 95% of the maximum standard Proctor density at the optimum moisture content and subsequently soaked for 96 hours before California Bearing Ration (CBR) tests were performed. The test results indicated a CBR value of 3.1%. The results of the testing are provided in Appendix C.

Thermal resistivity testing was conducted on the bulk soil sample of the silty clay collected from about 0.3 m to 1.5 m below ground surface at Borehole FY24-1. The bulk sample was recompacted to 85% of the soil's maximum dry density (MDD) and thermal dry-out curve populated based on the moisture content vs. the thermal resistivity measured with the needle probe. The results of the thermal resistivity testing are provided in Appendix C.

A one-dimensional consolidation (OED) test was carried out on one selected sample of the silty clay and the results are presented Appendix C.

#### **6.2.4 Silty Clay (Glacial Till)**

A deposit of silty clay till was encountered below the silty clay in Borehole FY24-6 at a depth of 3.0 m below ground surface. Borehole FY24-6 was terminated within the silty clay till at a depth of about 3.6 m below ground surface after encountering split-spoon refusal on inferred bedrock surface.

A measured SPT 'N' value within the silty clay till was 28 blows to per 0.3 m of penetration, suggesting a very stiff consistency.

The water content measured on a sample of the silty clay till was 25 percent.

#### **6.2.5 Granitic Gneiss Bedrock**

Granitic Gneiss bedrock was encountered below the overburden materials in all boreholes advanced at the site. The bedrock was inferred by split-spoon and auger refusal in Borehole FY24-2 to FY24-8 and confirmed by coring the rock in Borehole FY24-1. The bedrock was cored from 6.1 m to 9.1 m below ground surface. The bedrock core samples were described as fresh, extremely strong, fine to medium grained, very thinly bedded and grey, black, light pink and white in colour. Further details of the granitic gneiss bedrock are shown on the Record of Borehole/Corehole sheets in Appendix A. Photographs of the recovered bedrock cores are shown in Appendix E.

#### **6.2.6 Groundwater Conditions**

The groundwater level within the boreholes was monitored during advancement and in the open boreholes upon completion. A monitoring well was installed in Borehole FY24-1 for long term groundwater monitoring. Details of the monitoring well installation are shown on the Record of Borehole sheets in Appendix A.

The water level measured in the open boreholes upon completion of drilling ranged from about 1.0 m to 1.3 m below ground surface. At the time of this report, groundwater levels in the monitoring well had not been measured.

The groundwater level at the site is expected to fluctuate seasonally in response to change in the precipitation and snowmelt and is expected to be higher during the spring and during periods of precipitation.

### **6.3 Soil Chemical Testing**

Chemical tests, consisting of soil pH, soluble chlorides and soluble sulfates, were performed on two samples collected at the Project site. The results of the chemical testing indicate that soil had a pH ranging from 7.10 to 7.16, resistivity ranging from 106 to 175 Ohm\*m, and a soluble sulfate concentration ranging from 6 to 10 µg/g. The chemical test results are shown in Appendix D.

## **7. Geotechnical Discussion and Design Considerations**

This section of the report presents an interpretation of the factual geotechnical data to date and provides geotechnical design recommendations for the proposed BESS and associated structures. These discussions and recommendations are based on our understanding of the project and our interpretation of the factual data obtained from the December 2024 investigation.

This section of the report provides engineering information for the geotechnical design aspects of the project, based on our interpretation of the borehole data and on our understanding of the project requirements. The information in this portion of the report is provided for the guidance of the design engineers and professionals. Where comments are made on construction considerations, they are provided only to highlight aspects of construction which could affect the design of the project. Contractors bidding on or undertaking any work at the site should examine the factual results of the investigation, satisfy themselves as to the adequacy of the information for construction and make their own interpretation of the factual data as it affects their proposed construction techniques, schedule, equipment capabilities, costs, sequencing, and the like. If the project is modified in concept, location or elevation, Hatch should be given the opportunity to confirm that the recommendations in this report are still valid.

This report addresses only the geotechnical (physical) aspects of the subsurface conditions at this Site. The geo-environmental (chemical) aspects, including the consequences of possible surface and/or subsurface contamination resulting from previous activities or uses of the Site and/or resulting from the introduction onto the site of materials from off-site sources, are outside of the terms of reference for this report.

Based on the results of this investigation, the subsurface soil conditions encountered at the Site are considered to generally be suitable for the proposed development, which is understood to comprise of BESS structures, a substation structure, access roads and associated electrical servicing.

## 7.1 Site Preparation

### 7.1.1 *Subgrade Preparation*

It is understood from drawings provided to Hatch that the BESS development will consist of a BESS area, a substation area with site servicing and access roads. At the time of this report, a site grading plan was not provided. Therefore, it is assumed that minor cut and/or fill site grading operations (i.e., less than 0.5 m) will be required to establish subgrade levels and permit construction of the proposed development.

As discussed in Section 6.2, the subsurface conditions at the site generally consist of topsoil underlain by clayey soils of the Champlain Sea Basin deposit which varies in moisture content, consistency and plasticity across the site and with depth. The clay soils are underlain by strong to very strong gneiss bedrock which varies in elevation across the site. Based on the conditions encountered during the geotechnical investigation, in-situ testing and the results of the laboratory testing, the clayey soils are considered to be compressible in nature and prone to settlement when overstressed by external loads that are close to or exceeding the pre-consolidation pressure or yield stress of the soil. Such external loads include grade raises, equipment and structure foundations, pavement structure (if filling required) and the lowering of the groundwater table (if required).

In the areas of the site underlain by the clayey soils, as encountered across the site, large grade raises should be avoided to minimize settlement and should be kept to a maximum of 0.5 m. As noted, site grading details for the site were not known at the time of this report and, as such, when these details have been determined, if significant grade raises are required for the site, a detailed settlement analysis should be conducted to determine the long-term effects of the grade raises across the site and at settlement sensitive structure foundations such as the BESS “cabinets” and substation structures. If significant grade changes are required in areas with silty clay soils, preconsolidation measures (such as preloading) may be needed in advance of earthwork activities.

Any filling carried out at the Site in conjunction with grading (with the exception of future green spaces) should be carried out as engineered fill. Recommendations for the placement of engineered fill are outlined in Section 7.1.2 of this report. In general, the existing vegetation, surficial topsoil, reworked soil, the clayey soils or other near-surface soils containing significant amounts of organic matter are not considered to be suitable for the subgrade support of engineered fill, foundations, slabs or other settlement sensitive structures. These materials should be completely stripped prior to placing any engineered fill or construction of foundations or exterior slab-on-grade(s).

Following the stripping of the surficial topsoil, reworked soil, clayey soils, and/or soils containing significant amounts of organics and/or soft/disturbed areas, the exposed subgrade should be heavily proof-rolled with suitable equipment, such as a heavy roller or partially loaded truck, in conjunction with inspection by qualified geotechnical personnel to confirm that the exposed soils are competent and have been adequately stripped of ponded water and all disturbed, loosened, softened, organic and other deleterious material. Remedial work (i.e., further sub-excavation and replacement) should be carried out on poorly performing areas identified during the proof-rolling activities, as directed by a geotechnical professional. Poorly performing or disturbed areas should be excavated and removed to expose undisturbed competent soil or rock and backfilled to the design grade with Granular 'B'. If the depth of excavation becomes excessive and the very soft to firm clay is exposed, ground stabilizing measures may be required such as placing a Geogrid Reinforcement or use of chemical stabilization (i.e. lime, cement, and/or fly ash).

### **7.1.2 Engineered Fill Requirements**

As described above, the anticipated site grading activities are expected to include both cutting and raising (filling) the original grade to meet the final design site grades.

The native silty clay soils encountered in the boreholes advanced at the site are not considered suitable as engineered fill in settlement sensitive areas such as beneath proposed foundations, access roads or utilities. However, this material could be used for general grade raises in landscape areas around the proposed development.

Imported engineered fill will be required for any grade raises at the site in settlement sensitive areas. If imported material is required for the engineered fill process, the material that is proposed for use as engineered fill should be approved by the geotechnical engineer, at its source, prior to importing the material to the site. In this regard, imported materials which meet the requirements for OPSS Select Subgrade Material (SSM) would be suitable for use as engineered fill. Suitable soils, free of topsoil, organic matter, cobbles/boulders or other deleterious materials can be used as engineered fill provided that the water content of the soil at the time of placement does not vary by more than 2% above or below its optimum water content for compaction. Otherwise, the soils may require treatment (i.e., drying or wetting) prior to placement. All oversized cobbles (i.e., greater than 150 mm in size) and boulders, if present, should be removed from the material to be used as engineered fill material.

It should be noted that the native subsurface material at the site is susceptible to over-wetting and subsequent freezing during inclement weather. Therefore, it is recommended that site grading activities not be carried out during late fall, winter, early spring seasons or any periods of inclement weather conditions.

Following the inspection and approval of the subgrade as described previously in this report, engineered fill materials should be placed in maximum 300 mm thick loose lifts and uniformly compacted to 98% of the standard Proctor maximum dry density (SPMDD). Filling should continue until the design elevations are achieved. Full-time monitoring and in-situ density testing should be carried out during placement of engineered fill.

The final surface of the engineered fill should be protected, as necessary, from construction traffic and should be sloped to provide positive drainage for surface water during the construction period. If the engineered fill materials will be left exposed (i.e., uncovered) during periods of freezing weather, additional soil cover should be placed above final subgrade to provide some level of frost protection. Areas excavated and replaced with non-frost susceptible Granular 'B' fill should be topped with a minimum of 150 mm of Granular 'A' fill to reduce infiltration.

Where the BESS foundations will be founded on the bedrock surface (on bedrock outcrops or where the silty clay has been excavated), filling/levelling will be required to prepare a level surface to place the foundation. The filling should consist of Granular 'B' placed, as noted above, on the cleaned bedrock surface and grade raised to 150 mm below the final grade level. The final lift above the Granular 'B' should consist of a minimum of 150 mm Granular 'A' pad. Alternatively, where material is excavated over bedrock, filling/levelling could be achieved by pouring lean concrete on the bedrock up to the required design grades.

### **7.1.3 Excavations**

Details of the excavations for BESS foundations, substation area and underground servicing for the proposed development are unknown at the time of the preparation of this report; as such, for the purpose of this report, the maximum depth of the foundation footings and underground services was assumed to be up to about 2 m below the existing ground surface (below frost penetration depth). Once detailed design is completed, review of the required excavations should be completed by this office for compliance with the recommendations contained herein.

The founding soils are anticipated to generally consist of the native silty clay or bedrock. The upper 'weathered' silty clay material (encountered to about 2 to 3 m below ground surface) is considered to be suitable for supporting the BESS structures on shallow foundations consisting of strip or spread footings provided that the integrity of the base of the excavations is maintained during construction.

Slab-on-grade foundations placed on the native silty clay materials could be considered, however, the compressibility of subgrade soils could cause intolerable settlements of the slab-on-grade foundations. Therefore, once the design loads and settlement tolerances of the proposed BESS 'cabinets' are known, a detailed settlement analysis should be carried out to determine if the calculated settlements are tolerable. The slab-on-grade foundations are

considered to be suitable in areas where founded directly on the bedrock or on engineered fill placed above the bedrock following excavation of the native subsurface soils.

It is noted that the bedrock elevation varied considerably across the site from ground surface (exposed at surface) to greater than 7.5 m below ground surface. Therefore, foundation conditions and preparation will vary from structure to structure depending on the area of construction on the site.

Where softened or disturbed native soils or other deleterious materials are encountered at the base of excavations for settlement-sensitive foundations or underground services, these materials should be sub-excavated and replaced with compacted fills approved by the geotechnical engineer.

Care should be taken to direct surface water away from any open excavations and all temporary excavations should be carried out in accordance with the Occupational Health and Safety Act (OHSA) and Regulations for Construction Projects. In general, the groundwater levels measured in the open boreholes at the site ranged from about 1.0 m to 1.3 m below ground surface during the geotechnical investigation. The groundwater in the excavations within the native silty clay deposits are likely to be handled by collection via properly constructed and filtered sumps, located within the excavations, and then pumping and discharging the water to a suitable discharge point.

All temporary excavations must be carried out in accordance with the requirements of the OHSA. The soil types, as defined in the OHSA, for overburden soils present at the proposed BESS development site are summarized below as an aid for design:

- Firm to stiff silty clay (upper 2 m to 3 m) – Type 3 soil; and
- Very soft to soft silty clay (below 3 m depth) – Type 4 soil.

For open excavations, Type 3 and Type 4 soils must be sloped from the bottom of the excavation. Type 3 soils may have a slope no steeper than 1 horizontal to 1 vertical (1H:1V) and Type 4 soils may have a maximum allowable slope of 3H:1V. Depending upon the construction procedures adopted, the groundwater seepage conditions and weather conditions at the time of construction, some local flattening of the slopes of open cut excavations may be required, especially in looser/softer zones or where localized seepage is encountered. Further, layering of soils could affect the OHSA classification and, therefore, the classification of soils for OHSA purposes must be made at the time the excavation is open and can be directly observed during construction.

Where the side slopes of excavations are required to be steepened to limit the extent of the excavation, then some form of trench support may be required. Some trench excavations could be carried out using a vertically-excavated, unsupported excavation (using a properly-engineered trench liner box for protection, certified by an experienced engineer); or by a supported (sheeted) excavation if conditions warrant so; such as in wet areas and/or in close proximity to adjacent underground services.

The bedrock encountered at the site consists of granitic gneiss and was encountered at varying depths ranging from ground surface (noted visual outcrops during the geotechnical investigation) to greater than 7.5 m below ground surface in Borehole FY24-1. The bedrock was described as fresh and strong to very strong based on the recovered rock cores from Borehole FY24-1 and visual inspection of the outcrops noted at the site. If excavations of the bedrock are required to achieve design elevations, it is anticipated that the rock will need to be excavated using mechanical excavation methods which will be very slow due to the strength of the rock. Large hydraulic rock breakers with sufficient percussive force to break the rock will be required if blasting techniques are not allowed in the area.

## 8. Structures

It is understood that the BESS structures, or 'cabinets', are typically supported on deep foundation systems connected to a frame at the base of the structure. Typical deep foundation systems include drilled piers (caissons) or helical piers (ground screws). Based on the subsurface conditions encountered at the site, shallow foundations could also be considered for support of the BESS structures and other lightly loaded ancillary structures, including strip footings, spread footings or conventional slab-on-grade (in areas where founded on bedrock or engineered fill). Discussion of the shallow and deep foundation options that could be considered to support the BESS structures and/or ancillary structures is provided in the following sections.

### 8.1 Shallow Foundations

As noted in Section 6.2, the subsurface conditions in the area of the BESS structures consist of topsoil overlying generally soft to stiff silty clay which is underlain by strong to very strong granitic gneiss bedrock. As discussed above, the upper approximately 2 m to 3 m of the silty clay is generally firm to stiff ('weathered crust'), with the consistency becoming softer with depth (very soft to soft about 2 m to 3 m above the bedrock in the areas of thickest deposit).

Based on the subsurface conditions encountered at the site, strip and/or spread footings may be used for the proposed BESS structures and lightly loaded ancillary structures provided that the footings are founded in the upper 2 m of the silty clay, on the granitic gneiss bedrock or engineered fill placed on the bedrock at depths noted below and placed in accordance with the recommendations outlined in Section 7.1.

Based on the Ontario Provincial Standard Drawing (OPSD) 3090.010 entitled “Foundation Frost Penetration Depths for Southern Ontario”, the depth of frost penetration in the Ottawa area is approximately 1.8 m below ground surface. In order to provide adequate protection against frost damage, it is recommended that the shallow foundations be constructed a minimum of 1.8 m below finished ground surface or on bedrock (which is considered non-frost susceptible).

For strip and/or spread footings, the following preliminary geotechnical axial resistances at Ultimate Limit States (ULS) and at Serviceability Limit States (SLS, for 25 mm of settlement) may be assumed for design purposes. At the time of this report, the dimensions of the footings for the proposed structures were not provided. Therefore, a footing width of 0.5 m with a length of 6 m has been assumed for strip footings. For spread footings, the dimensions have been assumed to be 1 m by 1 m in area at a minimum depth of 1.8 m below ground surface.

**Table 8-1: Founding Elevations and Geotechnical Axial Resistances**

Foundation Element	Maximum Founding Depth Below Ground Surface (m)	Relevant Boreholes	Founding Soil	Factored Geotechnical Resistance at ULS (kPa)	Factored Geotechnical Resistance at SLS <sup>1</sup> (kPa)
BESS Structures	2.0	FY24-2 to FY24-9	Firm to Stiff Silty Clay	150	75
			Granitic Gneiss Bedrock	500	. <sup>2</sup>
Substation	2.0	FY24-1	Firm to Stiff Silty Clay	150	75
			Granitic Gneiss Bedrock	500	. <sup>2</sup>

**Note:**

1. SLS value for 25 mm of settlement.
2. SLS geotechnical resistance will be higher than the ULS resistance. Therefore, ULS will govern.

The factored geotechnical axial resistance at ULS and geotechnical reaction at SLS are dependent on the foundation size, depth, configuration and applied loads. The geotechnical resistance/reaction should, therefore, be reviewed once more detailed design information (i.e., footing size and depth) becomes available. The geotechnical resistance/reaction are based on loading applied perpendicular to the base of the footings. Where applicable, inclination of the load should be taken into account.

Where spread footings are constructed at different elevations, the difference in elevation between the individual footings should not be greater than one half the clear distance between the footings. In addition, the lower footings should be constructed first so that if it is necessary to construct the lower footings at a greater depth than anticipated, the elevation of the upper footings can be adjusted accordingly. Stepped strip footings should be constructed in accordance with the Ontario Building Code (2024), Section 9.15.3.9.

The maximum total and differential settlements are expected to be less than 25 mm and 20 mm; respectively, for footings designed, constructed and inspected as outlined above.

The native soils are susceptible to disturbance from construction activity, especially during wet or freezing weather. Care should be taken to preserve the integrity of the materials as bearing strata. It is essential that the founding surface for the footings be inspected by qualified geotechnical personnel prior to placing concrete. If the concrete for the footings cannot be placed immediately after excavation and inspection of the subgrade, it is recommended that a working mat of lean concrete be placed in the excavation to protect the integrity of the bearing stratum.

To avoid detrimental impacts from frost adhesion and heaving, the excavated areas behind any below grade foundation elements, such as the substation, should be backfilled with non-frost susceptible granular material conforming to the requirements for OPSS.MUNI 1010 Granular "B" Type I material. In areas where asphalt/concrete pavement or other hard surfacing (flatwork) will abut the structure, differential frost heaving could occur between the granular fill immediately adjacent to the structure and the more frost susceptible native materials which exist beyond the wall backfill. To reduce the severity of this differential heaving, the backfill adjacent to the wall should be placed to form a frost taper. The frost taper should be brought up to asphalt/concrete subgrade level from 1.8 m below finished exterior grade at a slope of 3 horizontal to 1 vertical, or flatter, away from the wall. The backfill materials should be placed evenly in lifts not exceeding 200 mm loose thickness. The layers should be compacted to at least 98% of the materials standard Proctor maximum dry density (SPMDD). Light compaction equipment should be used immediately adjacent to the walls; otherwise, compaction stresses on the wall may be greater than that imposed by the backfill material. The upper 0.3 m of backfill should consist of clayey material (in landscape areas) to provide a relatively low-permeability cap and the exterior grade should also be shaped to slope away from the structure.

Resistance to lateral forces/sliding resistance between the concrete footings and the subgrade should be calculated in accordance with Section 6.10.4 of the Canadian Highway and Bridge Design Code (CHBDC). The unfactored coefficient of friction,  $\tan \delta$ , for the interface between the cast-in-place concrete footing and the properly prepared subgrade can be assumed to be 0.31.

## 8.2 Slab-On-Grade

Conventional slab-on-grade foundation construction could be considered for the proposed BESS structure ‘cabinets’ at the site in areas of exposed bedrock or shallow bedrock where the near surface soils have been excavated and replaced with engineered fill. Slab-on-grade foundations could also be considered if constructed on the silty clay soils, however, the compressibility of subgrade soils could cause intolerable settlements of the slab-on-grade foundations. Therefore, once the design loads and settlement tolerances of the proposed BESS ‘cabinets’ are known, a detailed settlement analysis should be carried out to determine if the calculated settlements are tolerable.

The design of “raft” foundations is generally governed by settlement considerations rather than bearing capacity since the design bearing pressure is generally less than the allowable bearing capacity. Differential settlements may also occur along the length of the structure supported by a raft due to the variation in loading across the raft as well as potential variable soils/rock at the base elevation, as such, reinforcing steel should be incorporated into the raft slab to help mitigate differential settlement.

The modulus of vertical subgrade reaction or soil “spring constant” is a concept used in structure engineering; however, it is not related to fundamental soil properties. The values of “spring constants” for raft design can only be evaluated following a detailed settlement analysis and should be considered approximate only. The moduli of subgrade reaction provided has been adjusted from that interpreted for a 0.3 m by 0.3 m square plate and a minimum base slab thickness of 600 mm has been used as an indicator of relative base slab stiffness and effective foundation width for calculation using spring constants. The design modulus of subgrade reaction is derived based on the assumption that the soils overlying the bedrock have been stripped and covered with 200 mm thick pad of Ontario Provincial Standard Specification (OPSS) Granular ‘A’ compacted to 100% of the standard Proctor maximum dry density (SPMDD). A typical preliminary modulus of subgrade reaction,  $k_s$ , of 10 MPa/m may be considered assuming that the subgrade is not disturbed during construction, excavation subgrade is prepared according to recommendations in this report and adequate dewatering (if required) is undertaken to ensure an undisturbed subgrade.

As noted previously, the modulus of subgrade reaction is not a fundamental nor intrinsic soil property and will vary depending on the rigidity of the slab, the thickness of the granular bedding, and the thickness, type and stiffness of the subgrade at the location/elevation of the raft slab-on-grade. Where the design is sensitive to the specific modulus value(s) and the design details of the proposed foundations for the raft is confirmed (including founding level and contact stresses at the underside of the foundation) a detailed settlement analysis will need to be carried out, from which values of modulus of subgrade reaction across the foundation can be estimated.

For predictable performance of the floor slab, the existing topsoil or organic soils, reworked soil, silty clay overlying the bedrock (if encountered within the same excavation footprint), as well as any wet or disturbed material should be removed from within the proposed BESS slab-on-grade structure area. Provisions should be made for at least 200 mm of OPSS Granular 'A' to form the base for the slab.

Any bulk fill required to raise the grade to the underside of the Granular 'A' should consist of OPSS Granular 'B' Type II. The underslab fill should be placed in maximum 300 mm thick lifts and should be compacted to at least 98% of the materials standard Proctor maximum dry density (SPMDD) using suitable vibratory compaction equipment.

## 8.3 Deep Foundations

### 8.3.1 Drilled Pier (Caisson) Foundations

Drilled pier foundations (caissons) can be considered for support of the proposed BESS 'cabinet' structures, substation and ancillary structures. The factored ULS bearing resistance values provided below are based on a limit state resistance factor of 0.4. Based on the stratigraphic conditions, the recommended factored axial geotechnical resistance in compression at Ultimate Limit states (ULS) and the axial geotechnical resistance at Serviceability Limit States (SLS) for 600 mm diameter caissons founded on the granitic gneiss bedrock are provided in the table below. The bottom of the pile caps are assumed to be at a minimum of 1.8 m below ground surface (frost penetration depth) in soils with a minimum pile length of 3 m. Further, the minimum required pile length is based on the embedded depth skin friction and structure loads resisting adfreeze uplift forces within the frost penetration zone. Once the design structure loads and foundation type are determined the required pile lengths can be reassessed. Due to the expected fluctuations in the bedrock surface elevation, a minimum pile length has been assumed rather than a specific elevation. The axial resistance provided in the table below is based on end-bearing resistance only. It is expected that pile lengths across the site and even within the same BESS 'module' or across the substation foundation will vary.

**Table 8-2: Preliminary Geotechnical Axial Resistances for Caissons**

Recommended Minimum Caisson Length (m) and Anticipated Founding Stratum	Factored Geotechnical Axial Resistance at ULS (kN)	Geotechnical Resistance at SLS (kN)
3.0 m Granitic Gneiss Bedrock	500	.1

**Note:**

1. ULS value will govern the design as the SLS value for 25 mm of settlement is higher than the ULS value.

An approximately 1 m thick layer of saturated silty sand was encountered above the bedrock in Borehole FY24-1. Further, the native silty clay encountered at the site is sensitive soil and could “flow” into the auger hole during installation of the drilled pier if left unsupported. Therefore, the installation of caissons will likely require a temporary casing to provide support to the surrounding soil, and the use of drilling slurry to minimize disturbance to the soil sidewalls and balance the groundwater head. Due to the anticipated water inflow, concrete must be placed in caissons using tremie techniques. That is, the concrete must be discharged at the base of the caisson excavations, and flow upward to the ground surface. The tremie discharge should be maintained a minimum of 1 m below the surface of the wet concrete during placement and as the temporary liner is withdrawn. The performance of caissons in compression will depend, to a large degree, upon the final cleaning and verification of the condition of the bedrock surface at the base of the circular pile. For the caissons acting in compression, the base of each caisson excavation must be cleaned to remove all loose cuttings to ensure that the concrete is in contact with the competent undisturbed base.

All caisson/pile caps should be founded at a minimum depth of 1.8 m or provided with an equivalent thickness of insulation below the cap for frost protection, in accordance with OPSD 3090.101 (*Foundation Frost Penetration Depths for Southern Ontario*). In addition, the bearing soil and fresh concrete should be protected from freezing during cold weather construction.

### 8.3.2 **Helical (Screw) Piles**

Typically, helical (screw) piles are considered a proprietary foundation system due to variability in the use of pile materials and installation methods. Therefore, the provided design guidelines are for planning and preliminary design purposes only. Detailed design and verification of the installed capacity of helical piles is the responsibility of the proprietary foundation system designer/installer.

Helical pier foundation systems installed at the site should be augered through the overburden soils and bear on the granitic gneiss bedrock (end bearing pier). Due to the soft consistency and compressibility of the silty clay soils encountered on site, this material is not considered suitable to provide the required resistance as the applied loads on the helix would induce unacceptable settlements of the pier and, ultimately, the BESS ‘cabinet’ structures and ‘modules’. A helical pile system specifically intended to bear directly on sound bedrock should be selected for this project as penetration of the helices into rock is not anticipated. Consideration should be given by the foundation system designer of the helical pile shaft bearing on the undulating surface (varying depth and slope) of the bedrock encountered and observed at the site as a sloping contact may affect the capacity and feasibility of the pile.

Following advancement of the helical pier to refusal on the granitic gneiss bedrock, the top of the pier/foundation would then be attached to the foundations using brackets. Pre-compression should be induced in the helical pier prior to transferring the foundation loads to minimize the amount of post-construction settlement.

As the silty clay soils encountered at the site are considered sensitive and may “flow” during installation of drilled piers, as well as the high groundwater table which would require temporary casing in order to successfully install steel reinforcing and pour concrete, helical piers may be the preferred option for the South March site to support the proposed development structures due to the following advantages:

- Minimal disturbance of sensitive clays or saturated sands;
- Do not require temporary liners, placement steel reinforcing or tremie poured concrete;
- No vibration or excess soils to dispose;
- Adaptable to various subsurface conditions;
- Installation equipment require minimal footprint and can be installed with portable equipment (if required); and
- Can be installed shallow or deep (2 m to 60 m).

The number, size and design of the helical piles should be determined and confirmed by the supplier.

The number and size of the helical piles will need to be determined based on the loading and configuration of the support system of the BESS ‘cabinet’ structures. The project geotechnical information and structural loading should be provided to a specialist design-build contractor to assess the feasibility of this foundation system and to determine probable helical pile installation depths and capacities.

For preliminary design purposes, the table below provides the factored helical pile capacities based on end-bearing resistance on the granitic gneiss bedrock only (no shaft skin-friction resistance or resistance of helices founded in the overburden due to the soft consistency of the silty clay soils).

**Table 8-3: Preliminary Factored Geotechnical Axial Resistances for Helical Piles**

Recommended Minimum Caisson Length (m) and Anticipated Founding Stratum	Factored Geotechnical Axial Resistance at ULS (kN)	Geotechnical Resistance at SLS (kN)
3.0 m Granitic Gneiss Bedrock	500	-1

**Note:**

1. ULS value will govern the design as the SLS value for 25 mm of settlement is higher than the ULS value.

It is recommended that a pile load test program be completed on site prior to completion of detailed design to verify or amend capacity of the helical piles if suggested by the specialist contractor.

The actual depth of each helical pile is determined on site based on depth, torque measurements or noted refusal and load support requirements. Full time inspection of the installation of the helical piles by a geotechnical professional is recommended to confirm that the subsurface conditions are consistent with the findings of the geotechnical investigation which the design was based on.

Based on the fluctuating elevation of the bedrock across the site noted visually during the geotechnical investigation and encountered in the boreholes, it is expected that pile lengths across the site, and even within the same BESS 'module' or across the substation foundation, will vary.

### **8.3.3 Additional Design and Construction Recommendations**

Construction specifications for the drilled piles should include a concrete mix designed to limit bleeding. It is the contractor's responsibility to increase individual or group pile lengths and/or increase the number of piles to compensate for any soil disturbance created by the contractor's means and methods during construction.

To minimize disturbance of foundation soils, the contractor should drill piles using temporary casings where groundwater is present. After drilling, the casing should be extracted at a slow, uniform rate, with the pull in line with the center of the shaft. We recommend the contractor review this report and adjust drilled shaft installation means and methods accordingly.

A geotechnical professional or authorized representative should be on-site to observe drilled pile installation including drilling operations as well as concrete and reinforcing steel placement. The base of the drilled piles should be clean and free of debris or loose soil prior to pouring concrete or placing reinforcing steel. Concrete should be poured promptly after drilling to reduce exposing the subsoil to water or drying conditions. If foundation bearing strata are subjected to such conditions, the soils should be reevaluated before concrete is poured.

Free-fall concrete placement is not recommended unless approved by the structural engineer. The use of a bottom dump hopper or tremie pipe should be considered to prevent potential aggregate segregation or sidewall disturbance.

## **8.4 Lateral Earth Pressures**

The parameters (unfactored) provided below may be used to calculate the lateral earth pressures acting on ancillary structures such as the substation systems for excavation support, if required:

**Table 8-4: Lateral Earth Pressure Parameters**

Soil Type	Angle of Internal Friction (Deg)	Unit Weight (kN/m <sup>3</sup> )	Coefficients of Static Lateral Earth Pressure		
			At-Rest, K <sub>o</sub>	Active, K <sub>a</sub>	Passive, K <sub>p</sub>
New Granular Fill	35	22	0.43	0.27	3.69
Silty Clay	26	21	0.56	0.39	2.56
Silty Clay (Till)	32	21	0.47	0.31	3.25

The unit weight of water may be taken as 10 kN/m<sup>3</sup>. If the structure allows for lateral yielding, active earth pressures may be used in the design of the structure(s). If the structure does not allow for lateral yielding, at-rest earth pressures should be assumed for design.

## 8.5 Installation of Underground Services

### 8.5.1 Temporary Excavations

Details of underground servicing for the proposed development are unknown at the time of this investigation; as such, for the purpose of this report, the maximum depth of the underground services was assumed to be about 2 m below the existing ground surface. Once detailed design is completed, review of the underground services should be completed by this office for compliance with the recommendations contained herein.

At 2.0 m below existing ground surface, the founding soils for the proposed utilities are anticipated to be within the silty clay and silty clay till materials or on granitic gneiss bedrock. These materials are considered to be suitable for supporting the underground services provided that the integrity of the base of the trench excavations is maintained during construction. Where softened or disturbed native soils or other deleterious materials are encountered at the base of the excavations for settlement-sensitive services, these materials should be subexcavated and replaced with compacted fills approved by a geotechnical engineer.

Care should be taken to direct surface water away from any open excavations and all temporary excavations should be carried out in accordance with the Occupational Health and Safety Act (OHSA) and Regulations for Construction Projects.

In general, the groundwater level in the open boreholes upon completion of drilling was measured at a depth of about 1.0 m to 1.3 m below ground surface. In general, the excavations within the native silty clay and silty clay till deposits are likely to be handled by collection via properly constructed and filtered sumps, located within the excavations, and then pumping and discharging the water to a suitable discharge point.

For trench excavations (i.e., for servicing) extending predominantly through the silty clay and silty clay till material, it is anticipated that conventional temporary open cuts may be developed with side slopes not steeper than 1 horizontal to 1 vertical (1H:1V). Where the side slopes of excavations are required to be steepened to limit the extent of the excavation, then some form of trench support will be required. Trench excavations could be carried out using a vertically excavated, unsupported excavation (using properly engineered trench liner box for protection, certified by an experienced engineer); or by supported (sheeted) excavation if conditions warrant so; such as in wet areas and/or in close proximity to adjacent underground services. It must be emphasized that a trench liner box provides protection for construction personnel but does not provide any lateral support for adjacent excavation walls, underground services or existing structures (if any). It is imperative that any underground services or existing structures adjacent to the trench excavations be accurately located prior to construction and adequate support provided where required. Steepened excavations should only be left open for as short duration as possible and completely backfilled at the end of each working day.

As noted in Section 7.1.3, the bedrock encountered at the site was described as fresh and strong to very strong based on the recovered rock cores from Borehole FY24-1 and visual inspection of the outcrops noted at the site. If excavations of the bedrock are required for installation of underground utilities, it is anticipated that the rock will need to be excavated using mechanical excavation methods which will be very slow due to the strength of the rock. Large hydraulic rock breakers with sufficient percussive force to break the rock will be required if blasting techniques are not allowed in the area.

### **8.5.2** *Pipe Bedding and Cover*

The bedding for sewers and watermains should be compatible with the size, type and class of pipe and the surrounding subsoil and the requirements of the City of Ottawa. If granular bedding is deemed to be acceptable, then Ontario Provincial Standard Specifications (OPSS.MUNI 1010) Granular 'A' should be used from at least 150 mm below invert to springline. Clear stone should not be used as bedding material. From springline to 300 mm above invert of the pipe, sand cover could be used. All bedding and cover material should be placed in 150 mm loose lifts and uniformly compacted to at least 100% of SPMDD. Where variable fill materials, softened or disturbed native soils or other deleterious materials are encountered at the base of excavations, these materials should be sub-excavated and replaced with compacted fills approved by the geotechnical engineer.

### **8.5.3** *Trench Backfill*

The excavated materials from the Site will consist predominantly of silty clay and silty clay till. The materials encountered within the upper 2 m at the site are estimated to be near their estimated optimum water content for compaction and may be reused as backfill, however, should not be used in settlement sensitive areas (i.e., under access roads, foundations, etc.). The soils optimum water content should be maintained during placement. The soil excavated

below the groundwater level may be wet and as such may require some drying prior to placement and compaction.

Care should be taken to maintain the water content of the soils close to/at the optimum water content for compaction during the construction operations, as difficulties with compaction and/or backfill performance would be anticipated with fine-grained soils where the water content is significantly above the optimum for compaction purposes. Soils that contain significant quantities of organics or debris are not suitable for use as trench backfill within settlement sensitive areas. In addition, any cobbles or boulders greater than 150 mm in size should be removed from the trench backfill materials. If there is a shortage of suitable in-situ material, an approved imported material such as Ontario Provincial Standard Specifications Select Subgrade Material (SSM) should be used for trench backfill. As noted above, the trench backfill materials are silty in nature and are susceptible to wetting/freezing temperatures. Backfilling during cold or wet weather is not recommended.

Trench backfill should be placed in maximum 300 mm loose lifts and uniformly compacted to at least 98% of the material's SPMDD. Soil that is frozen should not be used as backfill.

Normal post-construction settlement of the compacted trench backfill should be anticipated with the majority of such settlement taking place within about 12 months following the completion of trench backfilling operations. These settlements will be reflected at the ground surface and in gravel access road construction areas. This may be compensated for, where necessary, by placing additional granular material prior to placing the final granular lift. Post-construction settlement of the restored ground surface in off-road trench areas is also expected and should be topped-up and re-landscaped, as required.

It should be noted that in some cases, even though the compaction requirements have been met, the subgrade strength in the trench backfill areas may not be adequate to support heavy construction loading, especially during wet weather or where backfill materials wet of optimum have been placed. In any event, the subgrade should be proof-rolled and inspected by qualified geotechnical personnel prior to placing the Granular 'B' subbase and additional subbase material placed as required, being consistent with the prevailing weather conditions and anticipated use by construction traffic.

It is understood that the underground cables associated with the BESS structures will require specialized backfill requirements based on the results of the soils thermal resistivity testing provided in Appendix C. Therefore, cable sizing and backfill requirements should be selected by the appropriate civil designer and is beyond the scope of the geotechnical recommendations provided in this report.

## 8.6 Access Road Design

Provided that preparation of the site is completed in accordance with recommendations stated above, the following access road structure should be suitable for construction based on subgrade conditions of silty clay and exposed bedrock.

**Table 8-5: Access Road Construction Details**

Subgrade Conditions	Pavement Layer	Material Description	Thickness (mm)
Silty Clay / Silty Clay Till	Base	OPSS.MUNI 1010 Granular 'A' <sup>1</sup>	300
	Subbase	OPSS.MUNI 1010 Granular 'B' (Type II) <sup>2</sup>	300
	Geogrid Requirement	Yes	
	Geotextile Requirement	Yes	
	<b>Total Thickness</b>	<b>600</b>	
Granitic Gneiss Bedrock	Base	OPSS.MUNI 1010 Granular A' <sup>1</sup>	250
	Subbase	OPSS.MUNI 1010 Granular 'B' (Type II) <sup>2</sup>	250
	Geogrid Requirement	No	
	Geotextile Requirement	No	
	<b>Total Thickness</b>	<b>500</b>	

**Notes:**

1. Compacted to 100% of SPMDD (ASTM D698).
2. Compacted to 98% of SPMDD.

During construction, the lift thicknesses should be placed in lifts not exceeding 200 mm loose thickness and compacted, as noted above, within 2% of the optimum moisture content. If any import fill is required, quality control shall be carried out during the placement and compaction of the fill. The fill must be placed under the supervision of a qualified Geotechnical Engineer in loose lifts not exceeding 200 mm. Field density tests must be taken on each lift of fill. Records of the field density results should be maintained and added to the construction records.

Surfaces of the roadways should be sloped at 2% or greater to promote runoff to designated surface drainage features and the subgrade should be crowned at the centreline and sloped at 3% minimum up to a maximum of 5% towards the roadway perimeter. The soils at the road subgrade level (directly beneath the topsoil) will become unstable and soft when wet or at certain times of the year, particularly the spring thaw. Due to the silty nature of the subgrade soils (in areas where bedrock is not exposed at the surface), it will be necessary to add a layer of geotextile reinforcing (e.g., Terrafix 300R or approved equivalent) between the

subgrade and geogrid (Tensar BX1500 or equivalent). Adjacent sheets of geotextile should be overlapped a minimum 450 mm.

## 9. Corrosivity Analysis

Analytical laboratory testing to assess the corrosion potential of the site soils was completed on two selected soil samples from the site. The soil samples were submitted for chemical analysis of sulphate, chlorides, pH and electrical resistivity. The results of the chemical testing indicate that soil had a pH ranging from 7.10 to 7.16, resistivity ranging from 106 to 175 Ohm\*m, and a soluble sulfate concentration ranging from 6 to 10 µg/g.

The resistivity testing results indicate that the soils tested generally have a “very low” steel corrosiveness potential based on the Ministry of Transportation Gravity Pipe Design Guidelines, 2014, Table 3.2 and negligible water soluble sulphate for sulphate attack on concrete based on Canadian Standards Association (CSA) A23.1 – Table 3. We note that a limited number of tests were carried out across the site and that corrosiveness of the site soils may vary with depth and material types.

## 10. Seismic Classification for Seismic Response

Seismic hazard is defined in the 2024 Ontario Building Code (OBC, 2024) by uniform hazard spectra (UHS) at spectral coordinates of 0.2 seconds, 0.5 seconds, 1.0 seconds and 2.0 seconds and a probability of exceedance of 2% in 50 years. The OBC method uses a site classification system defined by the average soil/bedrock properties (e.g., shear wave velocity, Standard Penetration Test (SPT) resistance, undrained soil shear strength, etc.) in the 30 m below the foundation level. There are six site classes from A to F, decreasing in ground stiffness from A, hard rock, to E, soft soil; with Site Class F used to denote problematic soils (e.g., sites underlain by thick peat deposits and/or liquefiable soils). The site class is then used to obtain acceleration and velocity-based site coefficients  $F_a$  and  $F_v$ , respectively, used to modify the UHS to account for the effects of site-specific soil conditions in design.

Based on the results of the geotechnical investigation, a Site Class E is estimated for planning purposes.

**Attachment:  
Figure 1**

DRAFT

Document Path: C:\Users\slne07010\Hatch\ELM\1375035 - Trailroad BESS Site Geotechnical Invest. - Trailroad BESS Inc. - WIP Uncontrolled\GIS\APRX\BoreholeLocationPlans - Figures\BoreholeLocationPlans - Figures.aprx

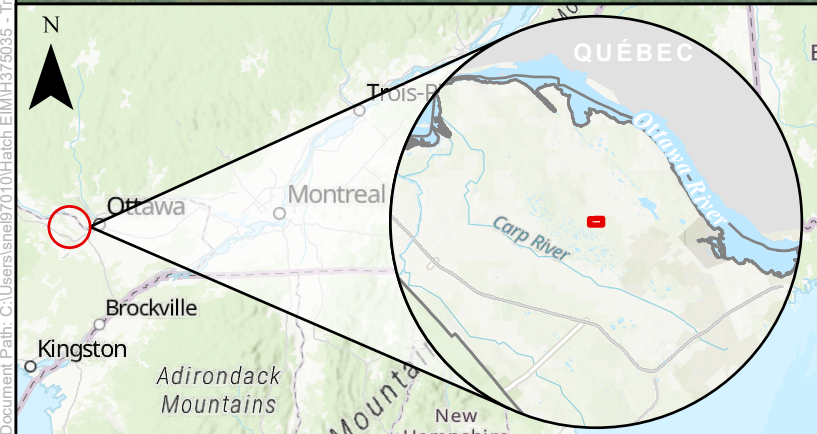
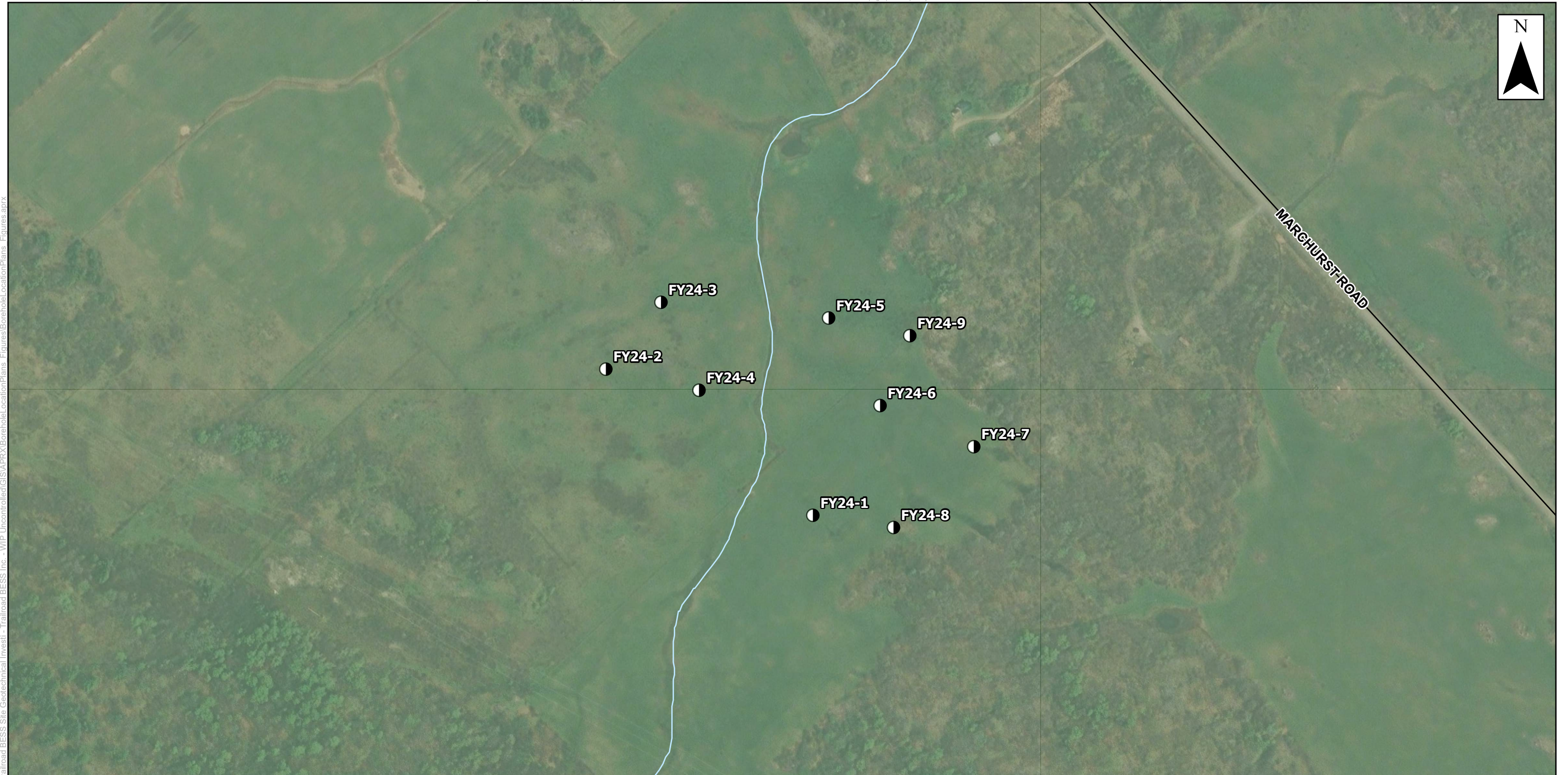

**LEGEND**

- Borehole
- Road
- Watercourse

**Notes**

1. Produced by Hatch, contains information under the Open Government License - Ontario
2. Spatial referencing: NAD 1983 UTM Zone 18N

1:3,000

<b>PROJECT:</b>		South March BESS			
<b>FIGURE TITLE:</b>		Borehole Location Plan			
<b>CLIENT:</b>		Brookfield BRP			
<b>DWG BY:</b> J. SNELGROVE	<b>CHK BY:</b> T. BEADLE	<b>FIG NO.:</b> 1	<b>REV NO.:</b> 1	<b>PROJ No.:</b> H375142	
<b>DATE:</b> December 19, 2024	<b>PAGE:</b> 1 of 1				

# Appendix A

## Record of Boreholes

DRAFT

# HATCH List of Abbreviations and Terms Used in the Borehole Reports

(Sheet 1)

## General

### Elevations

Elevations are referenced to datum indicated.

### Depth

All depths are given in meters (feet) measured from the ground surface unless otherwise noted.

### Sample Recovery

Indicates the length retained in millimeters (inches) in a split spoon sampler or percentage recovery of sample retained in the core barrel sampler.

### Sample Number

Samples are numbered consecutively in the order in which they were obtained in the borehole.

### Sampler Size

Dimension is in millimetres and refers to the outside diameter of the sampler.

### Sample Type

The first letter describes the sampling method and the second, the shipping container.

### Sampling Method

A – Split Tube	E – Auger
B – Thin Wall Tube	F – Wash
C – Piston Sampler	G – Shovel Grab Sample
D – Core Barrel	K – Slotted Sampler

### Shipping Container

N – Insert (split spoon)	S – Plastic Bag
O – Tube	U – Wooden Box
P – Water Content Tin	X – Plastic & PVC Sleeve (Sonic)
Q – Jar	Y – Core Box
R – Cloth Bag	Z – Discarded

### Abbreviations

N/A – Not applicable  
N/E – Not encountered  
N/O – Not observed

## Soil

### Soil Description, Label and Symbol

Soil description under the “Description” column conforms generally, but not rigorously, to the Unified Soils Classification System. For a given soil unit, defined by depth boundaries, the descriptive text constitutes the definitive soil unit description and takes precedence over both the brief label and the symbol used to graphically represent the soil unit.

### Grain Size

Clay	<0.002 mm
Silt	0.002 – 0.075 mm
Sand	0.075 – 4.75 mm
Gravel	4.75 – 75 mm
Cobbles	75 – 300 mm
Boulder	>300 mm

### Relative Quantities

Term	Example	(%)
Trace	Trace sand	1 – 10
Some	Some sand	10 – 20
With	With Sand	20 – 35
And	And sand	>35
Noun	Sand	>50

### Standard Penetration Test (SPT)

The test is carried out in accordance with ASTM D-1586 and the ‘N’ value corresponds to the sum of the number of blows required by a 63.5-kg (140-lb) hammer, dropped 760 mm (30 in.), to drive a 50-mm (2-in.) diameter split tube sampler the second and third 150 mm (6 in.) of penetration.

### Density (Granular Soils)

	N(SPT)
Very loose	0 – 4
Loose	4 – 10
Compact	10 – 30
Dense	30 – 50
Very dense	>50

### Consistency (Cohesive Soils)

	N(SPT)
Very soft	<2
Soft	2 – 4
Firm	4 – 8
Stiff	8 – 15
Very stiff	15 – 30
Hard	>30

### Plasticity/Compressibility

		Liquid Limit (%)
Low plasticity clays	Low compressibility silts	<30
Medium plasticity clays	Medium compressibility silts	30 – 50
High plasticity clays	High compressibility silts	>50

### Dilatancy

None - No visible change.  
Slow - Water appears slowly on surface of specimen during shaking and does not disappear or disappears slowly upon squeezing.  
Rapid - Water appears quickly on the surface of specimen during shaking and disappears quickly upon squeezing.

### Sensitivity

Insensitive	<2
Low	2 – 4
Medium	4 – 8
High	8 – 16
Quick	>16

## Rock

### Core Recovery

Sum of lengths of rock core recovered from a core run, divided by the length of the core run and expressed as a percentage.

### RQD (Rock Quality Designation)

Sum of lengths of hard, sound pieces of rock core equal to or greater than 100 mm from a core run, divided by the length of the core run and expressed as a percentage. Measured along centerline of core. Core fractured by drilling is considered intact. RQD normally quoted for N-size core.

### RQD (%) Rock Quality

90 - 100	Excellent
75 - 90	Good
50 - 75	Fair
25 - 50	Poor
0 - 25	Very Poor

### Grain Size

<b>Term</b>	<b>Grain Size</b>
Very coarse-grained	>60 mm
Coarse-grained	2 mm - 60 mm
Medium-grained	60 µm - 2 mm
Fine-grained	2 µm - 60 µm
Very fine-grained	< 2 µm

### Bedding

<b>Term</b>	<b>Bed Thickness</b>		
Very thickly bedded	>2 m		>6.50 ft
Thickly bedded	600 mm - 2 m	2.00 - 6.50 ft	
Medium bedded	200 mm - 600 mm	0.65 - 2.00 ft	
Thinly bedded	60 mm - 200 mm	0.20 - 0.65 ft	
Very thinly bedded	20 mm - 60 mm	0.06 - 0.20 ft	
Laminated	6 mm - 20 mm	0.02 - 0.06 ft	
Thinly laminated	<6 mm	<0.02 ft	

### Discontinuity Frequency

Expressed as the number of discontinuities per metre or discontinuities per foot. Excludes drill-induced fractures and fragmented zones.

### Discontinuity Spacing

<b>Term</b>	<b>Average Spacing</b>		
Extremely widely spaced	>6 m		>20.00 ft
Very widely spaced	2 m - 6 m	6.50 - 20.00 ft	
Widely spaced	600 mm - 2 m	2.00 - 6.50 ft	
Moderately spaced	200 mm - 600 mm	0.65 - 2.00 ft	
Closely spaced	60 mm - 200 mm	0.20 - 0.65 ft	
Very closely spaced	20 mm - 60 mm	0.06 - 0.20 ft	
Extremely closely spaced	<20 mm	<0.06 ft	

Note: Excludes drill-induced fractures and fragmented rock.

### Broken Zone

Zone of full diameter core of very low RQD which may include some drill-induced fractures.

### Fragmented Zone

Zone where core is less than full diameter and RQD = 0.

### Strength Term

<b>Description</b>	<b>Unconfined Compressive Strength</b>	
	<b>(MPa)</b>	<b>(psi)</b>
Extremely weak rock	0.25 - 1.0	36 - 145
Very weak	1.0 - 5.0	145 - 725
Weak rock	5.0 - 25	725 - 3625
Medium strong rock	25 - 50	3625 - 7250
Strong rock	50 - 100	7250 - 14500
Very strong rock	100 - 250	14500 - 36250
Extremely strong rock	>250	>36250

<b>Weathering Term</b>	<b>Description</b>
Fresh	No Visible sign of rock material weathering
Faintly weathered	Discoloration on major discontinuity surfaces.
Slightly weathered	Discoloration indicates weathering of rock material and discontinuity surfaces. All the rock material may be discolored by weathering and may be somewhat weaker than in its fresh condition.
Moderately weathered	Less than half of the rock material is decomposed and/or disintegrated to a soil. Fresh or discolored rock is present either as a continuous framework or as corestones.
Highly weathered	More than half of the rock material is decomposed and/or disintegrated to a soil. Fresh or discolored rock is present either as a discontinuous framework or as corestones.
Completely weathered	All rock material is decomposed and/or disintegrated to a soil. The original mass structure is still largely intact.
Residual soil	All rock material is converted to soil. The mass structure and material fabric are destroyed. There is a large change in volume, but the soil has not been significantly transported.

# HATCH BASIS FOR SOIL DESCRIPTION

(Based on ASTM D 2488-17, with modifications)

## UNIFIED CLASSIFICATION (in order of description)

Soil Name (BLOCK LETTERS);

Plasticity or grading characteristics for major components,

Plasticity or grading characteristics for secondary components,

Colour of soil,

Other minor components - name, plasticity or particle characteristics and colour,

Moisture conditions,

Consistency,

Structure, and

Additional observations such as ORIGIN or other significant features not relating to the composition, condition or structure of the soil.

The terms used in the unified classification are described below:

## PARTICLE SIZE DISTRIBUTION

Clay	Silt	Sand			Gravel		Cobble	Boulder
		Fine	Medium	Coarse	Fine	Coarse		
0.002m	0.075m	0.425m	2.0mm	4.75mm	19mm	75mm	300mm	

## CLASSIFICATION OF SOILS

The Classification of soils is based on particle size distribution and plasticity, in general accordance with ASTM D 2488 - 17 Standard Practice for Description and Identification of Soils

## SOIL NAME

The Soil Name is based on the grain size characteristics and plasticity. As most soils are a combination of a range of constituents, the primary soil is described and modified by minor components, as follows:

Coarse Grained Soil (<50% Clay and Silt content)		Fine Grained Soil (>50% Clay and Silt content)	
% Fines	Modifier	% Fines	Modifier
≤ 5%	Omit, or use "trace"	≤ 15%	Omit, or use "trace"
> 5% ≤ 15%	Describe as 'with clay/silt' as applicable	> 15% ≤ 30%	Describe as 'with sand/gravel' as applicable
> 15%	Prefix soil as 'silty/clayey' as applicable	> 30%	Prefix soil as 'sandy/gravelly' as applicable

## PLASTICITY

Plasticity of clay and silt, both alone and in mixtures with coarser material, are described as:

Descriptive Term	Range of Liquid Limit	Field Guide to Plasticity
Of low plasticity	≤ 35%	The thread can barely be rolled and the lump cannot be formed when drier than the plastic limit
Of medium plasticity	> 35% ≤ 50 %	The thread is easy to roll and not much time is required to reach the plastic limit. The thread cannot be rerolled after reaching the plastic limit. The lump crumbles when drier than the plastic limit
Of high plasticity	>50%	It takes considerable time rolling and kneading to reach the plastic limit. The thread can be rerolled several times after reaching the plastic limit. The lump can be formed without crumbling when drier than the plastic limit

## GRADING CHARACTERISTICS

For coarse grained soils only, grading is described as follows:

Descriptive Term	Characteristics
Well Graded	Having good representation of all particle sizes
Poorly Graded	With one or more intermediate sizes poorly represented
Gap Graded	With one or more intermediate sizes absent
Uniform	Essentially of one size

# HATCH BASIS FOR SOIL DESCRIPTION

(Based on ASTM D 2488-17, with modifications)

## PARTICLE SHAPE

The particle shape of equidimensional particles may be described as 'rounded', 'sub-rounded', 'sub-angular' or 'angular' as shown in the sketches overleaf. Two-dimensional particles with the third dimension small by comparison may be described as 'flaky' or 'platy'. One-dimensional particles with the other two dimensions small by comparison may be described as 'elongated'

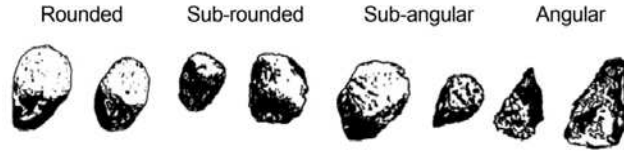

## COLOUR

The soil colour is described for soil in the 'moist' condition, using simple terms such as 'black', 'white', 'grey', 'brown', 'red', 'orange', 'yellow', 'green' or 'blue'. These may be modified as necessary by 'pale', 'dark' or 'mottled'. Borderline colours may be described as red-brown. Where a soil colour consists of a primary colour with a secondary mottling it should be described as: (primary colour) mottled (secondary colour), eg. grey mottled red-brown clay.

## MOISTURE CONDITION

Descriptive Term	General	Granular Soil	Cohesive Soil
'Dry' (D)		Cohesionless and free running	Hard and friable or powdery, well dry of plastic limit
'Moist' (M)	Soil feels cool,	Particles tend to cohere	Soil may be moulded by hand
'Wet' (W)	darkened in colour	Soil particles tend to cohere, free water forms when squeezed	Soil usually weakened and free water forms when handled

## CONSISTENCY (Cohesive soils)

The consistency of cohesive soil is based on the undrained shear strength and is generally estimated, with or without the aid of a pocket penetrometer or shear vane test.

Descriptive Term	Undrained Shear Strength (kPa)	Field Guide to Consistency
'Very Soft' (VS)	$\leq 12$	Exudes between the fingers when squeezed in hand
'Soft' (S)	$>12 \leq 25$	Can be moulded by light finger pressure
'Firm' (F)	$>25 \leq 50$	Can be moulded by strong finger pressure
'Stiff' (St)	$> 50 \leq 100$	Cannot be moulded by fingers
Very Stiff (VSt)	$>100 \leq 200$	Can be indented by thumb nail
'Hard' (H)	$>200$	Can be indented with difficulty by thumb nail

# HATCH BASIS FOR SOIL DESCRIPTION

(Based on ASTM D 2488-17, with modifications)

## DENSITY (Granular soils)

The density of a non-cohesive soil is described via the Density Index (relative density), which is generally assessed using a penetration test and published correlations.

Descriptive Term	Density Index (%)	SPT N-Value	Scala blows per 100mm	CPT $q_c$ (MPa)*
'Very Loose' (VL)	$\leq 15$	0-4	0-2	<5
'Loose' (L)	>15 $\leq$ 35	4-10	2-6	5-10
'Compact' (C)	>35 $\leq$ 65	10-30	6-16	10-15
'Dense' (D)	>65 $\leq$ 85	30-50	16-26	15-20
'Very Dense' (VD)	>85	>50	>26	>20

\* At an effective overburden pressure of 100k

## GRAPHIC SYMBOLS FOR SOILS

GRAVEL	poorly graded -		SILT	of low plasticity -		ICE -	
	well graded -			of high plasticity -			COBBLES AND BOULDERS -
SAND	poorly graded -		CLAY	of low plasticity -		ORGANIC/ PEATY SOIL -	
	well graded -			of high plasticity -		FILL/ MADE GROUND -	

Composite soil types are presented using combined symbols, eg. **Gravelly Sandy CLAY**

## GROUNDWATER OBSERVATIONS

Permanent Water Level		Inflow into Pit or Borehole		Slow Inflow/ Seepage into Pit or Borehole	
Temporary Water Level		Outflow/ Water Loss in Borehole			

## SAMPLE TYPES

Disturbed bag sample		Auger Flight Cuttings		Thin walled "undisturbed" push tube sample eg. U60, U100 etc	
Bulk Disturbed (>20kg)		Standard Penetration Test (SPT), with Disturbed Split-Spoon Sample			
Hollow Stem Auger Core		SPT (no recovery)		Sample attempted with no recovery	

### RUN AND RECOVERY

Every time the core barrel is lifted to recover a sample of the core one run is completed. The core recovery represents the ratio of core recovered to the length drilled for the corresponding core run and is expressed as a percentage. Intervals where no core is recovered are described as Core Loss and are denoted by CL.

### ROCK QUALITY DESIGNATION (RQD)

Rock Quality Designation (RQD) is an index or measure of the quality of a rock mass. RQD is determined by the ratio of sound core recovered in pieces over 100mm to the length of the core run drilled. Mechanical breaks are discounted in the calculation. RQD is not determined for extremely to highly weathered rock.

The descriptive terms assigned to RQD are as follows:

RQD (%)	Rock Description
< 25	Very Poor
25 to 50	Poor
50 to 75	Fair
75 to 90	Good
90 to 100	Excellent

### DEFECT SPACING

The defect spacing is a measure of the distance between natural discontinuities (drilling breaks are ignored), and is generally expressed in millimeters. The descriptive terms assigned to defect spacing are as follows:

Defect Spacing (mm)	Term
> 2,000	Extremely Wide
600 - 2,000	Very Wide
200 - 600	Wide
60 - 200	Moderately Wide
20 - 60	Moderately Narrow
6 - 20	Narrow
< 6	Very Narrow

### DEFECT LOG

The defect log provides a graphical description of each defect in the recovered core sample observed during logging.

### DEFECT DESCRIPTION AND COMMENTS

The defect description is an annotated description of rock defects including inclination/dip, type, infill type and amount, aperture, planarity, roughness and frequency of the defect. Other comments are also included under the defect description title.

The description format of an individual defect is as follows:

<i>Inclination</i>	<i>Type</i>	<i>Infill</i>	<i>Amount</i>	<i>Aperture</i>	<i>Planarity</i>	<i>Roughness</i>	<i>Frequency</i>
30°	J	Fe	Fi	Mw	Pl	Sm	C

### *Inclination*

For specific defects, the inclination of each individual defect is noted in degrees and is measured perpendicular to the core axis. For example, in a vertically drilled borehole, an inclination of 0° corresponds to a horizontal defect and an inclination of 90° corresponds to a vertical defect.

Continue overleaf...

### ROCK CLASSIFICATION (in order of description)

Rock Name (BLOCK LETTERS);  
 Grain Size,  
 Texture and Fabric,  
 Colour,  
 Other minor components - name, particle characteristics and colour,  
 Strength,  
 Weathering,  
 Structure of the rock,  
 Defects - type, orientation, spacing, roughness, waviness and persistency, and  
 Additional rock mass observations noted from larger exposures.

### WEATHERING

The Rock material weathering terms are defined in the Table below. The terms have been adopted from a combination of those used in AS1726-1981 and 1993.

Term	Symbol	Description
Residual Soil	RS	Soil developed on extremely weathered rock. The mass structure and substance fabric are no longer evident. There is a large change in volume but the soil has not been significantly transported.
Extremely Weathered Rock	XW	Rock substance affected by weathering to the extent that the rock exhibits soil properties, ie. it can be remoulded and classified in accordance with the Unified Soil Classification System.
Highly Weathered Rock	HW	Rock is weathered to such an extent that it shows considerable change in appearance and loss in strength. Chemical or physical decomposition of individual minerals are usually evident. The colour and strength of the original fresh rock is no longer recognisable.
Moderately Weathered Rock	MW	Rock is affected by weathering to the extent that staining extends throughout the whole of the rock substance and the original colour of the fresh rock is no longer recognisable. There is usually a significant loss in rock strength.
Slightly Weathered Rock	SW	Rock is slightly discoloured but shows little or no change of strength from fresh rock.
Fresh Rock	Fr	Rock shows no sign of decomposition or staining.

### ROCK STRENGTH

The rock strength terms defined in AS1726-1993 and generally based on Point Load index testing. In weaker rocks Unconfined Compressive Strength testing may provide a better estimate for the rock strength. In the absence of either Point Load or Unconfined Compression Strength testing, the rock strength may be based on field estimates as described in the Table below.

Term	Symbol	Point load index (MPa) $Is_{50}$	Unconfined Compression (MPa) UCS	Field guide to strength
Extremely Low	EL	$\leq 0.03$	$\leq 0.7$	Easily remoulded by hand to a material with soil properties.
Very Low	VL	$> 0.03 \leq 0.1$	$> 0.7 \leq 2.4$	Material crumbles under firm blows with sharp end of pick, can be peeled with knife, too hard to cut a triaxial sample by hand, pieces up to 30mm thick can be broken by finger pressure.
Low	L	$> 0.1 \leq 0.3$	$> 2.4 \leq 7.0$	Easily scored with a knife, indentations 1mm to 3mm show in the specimen with firm blows of the pick point, has dull sound under hammer. A piece of core 150mm long by 50mm diameter may be broken by hand. Sharp edges of core may be friable and break during handling.
Medium	M	$> 0.3 \leq 1.0$	$> 7.0 \leq 24$	Readily scored with a knife, a piece of 150mm long by 50mm diameter can be broken by hand with difficulty.
High	H	$> 1.0 \leq 3.0$	$> 24 \leq 70$	A piece of core 150mm long by 50mm diameter cannot be broken by hand but can be broken by a pick with a single firm blow, rock rings under hammer blows.
Very High	VH	$> 3.0 \leq 10$	$> 70 \leq 240$	Hand specimen break with pick after more than one blow, rock rings under hammer blows.
Extremely High	EH	$> 10$	$> 240$	Specimen requires many blows with geological pick to break through intact material, rock rings under hammer blows.

Continue overleaf...

# BOREHOLE RECORD

**FY24-1**

Client: Brookfield BRP	Final Depth: 9.14 m	Easting: 340,593.57 m
Project: South March BESS	Coord. System: NAD83 / MTM zone 9N	Northing: 5,028,520.19 m
Project No: H375035	Location:	Vertical Datum: CGVD2013
Elevation: 100.89 m		

Contractor: OGS	Rig Type: CME 45 Trackmount	Bearing:	Date Logged: Dec 01-Dec 02, 2024	Logged by: TV/DC
Driller: Jamie	Hole Diam (mm): 83	Inclination: 90.00°	Date Checked:	Reviewed by: TWB

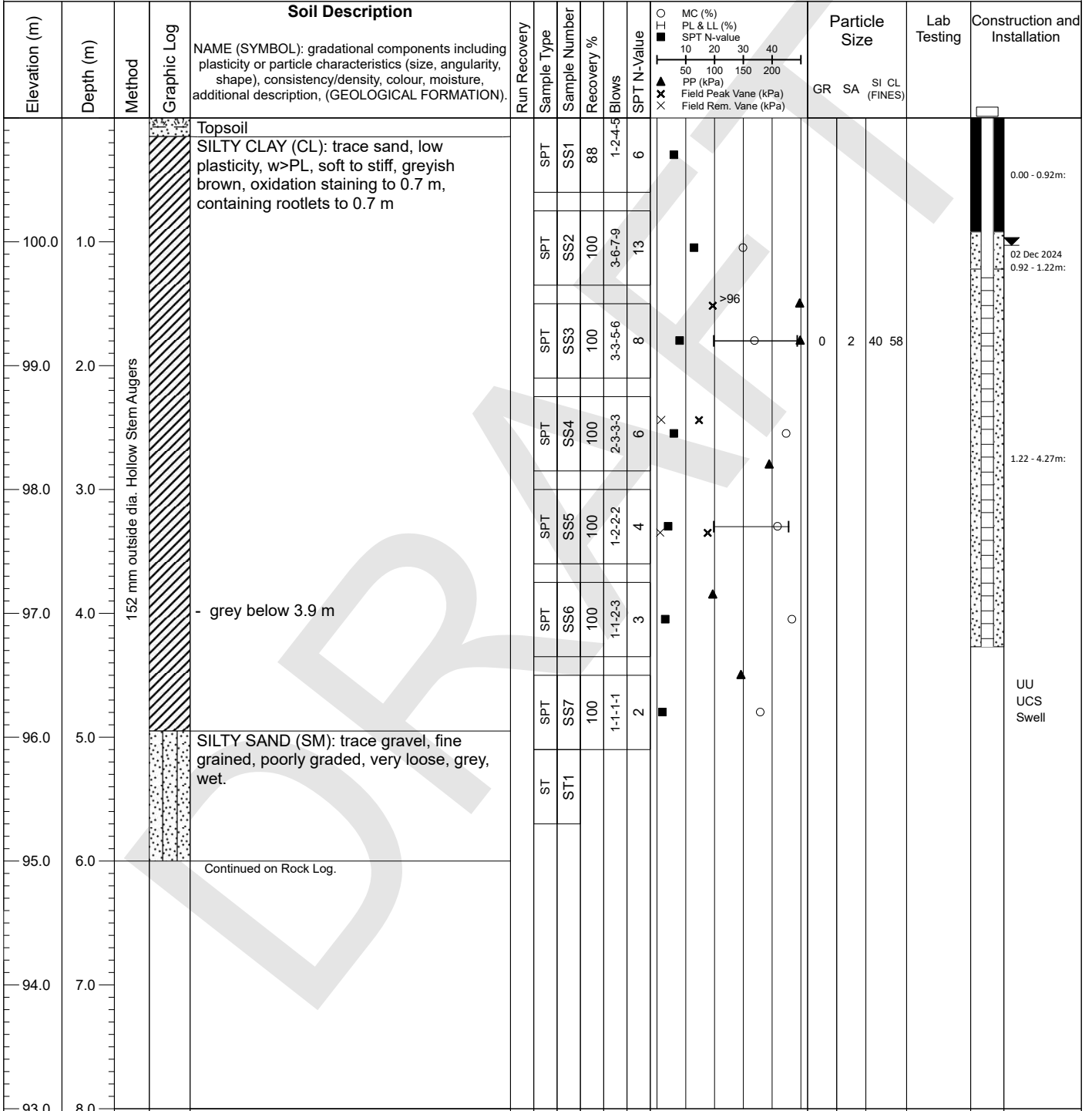

**Notes:**

1. Water level in open borehole measured at a depth of 1.0 m below ground surface on Dec. 3, 2024.
2. Shelby Tube (T.O) sample taken at a depth of 4.6 m - 5.2 m below ground surface in a borehole advanced adjacent to Borehole FY24-1. Vane shear tests performed in the same adjacent borehole.
3. Monitoring well installed in an adjacent borehole about 1.5 m northwest of Borehole FY24-1 on January 16, 2025. Water level in open borehole at a depth of 2.7 m below ground surface prior to installing monitoring well.
4. Additional shear vane tests were conducted in the adjacent borehole

Sheet 1 of 3

# BOREHOLE RECORD

**FY24-1**

<b>Client:</b> Brookfield BRP	<b>Final Depth:</b> 9.14 m	<b>Easting:</b> 340,593.57 m
<b>Project:</b> South March BESS	<b>Coord. System:</b> NAD83 / MTM zone 9N	<b>Northing:</b> 5,028,520.19 m
<b>Project No:</b> H375035 <b>Location:</b>	<b>Vertical Datum:</b> CGVD2013	<b>Elevation:</b> 100.89 m
<b>Contractor:</b> OGS	<b>Rig Type:</b> CME 45 Trackmount	<b>Bearing:</b>
<b>Driller:</b> Jamie	<b>Hole Diam (mm):</b> 83	<b>Inclination:</b> 90.00°
<b>Date Logged:</b> Dec 01-Dec 02, 2024		<b>Logged by:</b> TV/DC
<b>Date Checked:</b>		<b>Reviewed by:</b> TWB

DEPTH SCALE (m)	DRILL RIG	DRILL METHOD	MATERIAL PROFILE			RUN NO.	RECOVERY			WEATHERING	ROCK STRENGTH	FRACTURE FREQ. (mm)	DISCONTINUITY	NOTES & LABORATORY RESULTS	Construction and Installation	
			DESCRIPTION	STRATA PLOT	ELEV. DEPT H (m)		TCR %	SCR %	ROD %							TYPE AND SURFACE DESCRIPTION
			See Soil Log.													
6			Granitic Gneiss Bedrock.	94.8 6												
7	152 mm outside dia. Hollow Stem Augers		Granitic Gneiss Bedrock - fresh, extremely strong, fine to medium grained, very thinly bedded, grey, black, light pink and white.	6.14	1	100	82	FR	R6	300						
8																

Notes:

# BOREHOLE RECORD

**FY24-1**

<b>Client:</b> Brookfield BRP	<b>Final Depth:</b> 9.14 m	<b>Easting:</b> 340,593.57 m
<b>Project:</b> South March BESS	<b>Coord. System:</b> NAD83 / MTM zone 9N	<b>Northing:</b> 5,028,520.19 m
<b>Project No:</b> H375035 <b>Location:</b>	<b>Vertical Datum:</b> CGVD2013	<b>Elevation:</b> 100.89 m

<b>Contractor:</b> OGS	<b>Rig Type:</b> CME 45 Trackmount	<b>Bearing:</b>	<b>Date Logged:</b> Dec 01-Dec 02, 2024	<b>Logged by:</b> TV/DC
<b>Driller:</b> Jamie	<b>Hole Diam (mm):</b> 83	<b>Inclination:</b> 90.00°	<b>Date Checked:</b>	<b>Reviewed by:</b> TWB

DEPTH SCALE (m)	DRILL RIG	DRILL METHOD	MATERIAL PROFILE			RUN NO.	RECOVERY						WEATHERING	ROCK STRENGTH	FRACTURE FREQ. (mm)	DEPTH	DISCONTINUITY	NOTES & LABORATORY RESULTS	Construction and Installation	
			DESCRIPTION	STRATA PLOT	ELEV. DEPT H (m)		TCR %		SCR %		ROD %									TYPE AND SURFACE DESCRIPTION
							20	40	20	40	20	40								
9	152 mm outside dia. Hollow Stem Augers		Granitic Gneiss Bedrock - fresh, extremely strong, fine to medium grained, very thinly bedded, grey, black, light pink and white.		91.86	2	100													
9.14			End of corehole at 9.14 m.	9.14																
10																				
11																				
12																				
13																				
14																				
15																				
16																				

Notes:

# BOREHOLE RECORD

**FY24-2**

<b>Client:</b> Brookfield BRP	<b>Final Depth:</b> 1.20 m	<b>Easting:</b> 340,428.35 m
<b>Project:</b> South March BESS	<b>Coord. System:</b> NAD83 / MTM zone 9N	<b>Northing:</b> 5,028,632.28 m
<b>Project No:</b> H375035	<b>Location:</b>	<b>Vertical Datum:</b> CGVD2013
<b>Contractor:</b> OGS	<b>Rig Type:</b> CME 45 Trackmount	<b>Bearing:</b>
<b>Driller:</b> Jamie	<b>Hole Diam (mm):</b> 83	<b>Inclination:</b> 90.00°
	<b>Date Logged:</b> Dec 03, 2024	<b>Logged by:</b> TV/DC
	<b>Date Checked:</b>	<b>Reviewed by:</b> TWB

Elevation (m)	Depth (m)	Method	Graphic Log	Soil Description	Run Recovery	Sample Type	Sample Number	Recovery %	Blows	SPT N-Value	Particle Size				Lab Testing
											GR	SA	SI	CL (FINES)	
99.0	1.0	152 mm outside dia. Hollow Stem Augers	 <p>Topsoil SILTY CLAY (CL): trace sand, low plasticity, w&gt;PL, soft to very stiff, greyish brown, oxidation staining, containing rootlets to 0.7 m, reworked - silty sand seams below 0.7 m</p>	SPT	SS1	75	1-1-2.4	3	■	○					
99.0	1.0				SPT	SS2	100	8-10-13-50	23	■	○				
98.0	2.0			1.20 m END OF BOREHOLE Auger Refusal											
97.0	3.0														
96.0	4.0														
95.0	5.0														
94.0	6.0														
93.0	7.0														
92.0	8.0														

Notes: 1. Borehole dry upon completion of drilling

# BOREHOLE RECORD

**FY24-3**

<b>Client:</b> Brookfield BRP	<b>Final Depth:</b> 2.85 m	<b>Easting:</b> 340,470.80 m
<b>Project:</b> South March BESS	<b>Coord. System:</b> NAD83 / MTM zone 9N	<b>Northing:</b> 5,028,685.75 m
<b>Project No:</b> H375035	<b>Location:</b>	<b>Vertical Datum:</b> CGVD2013
<b>Elevation:</b> 99.04 m		

<b>Contractor:</b> OGS	<b>Rig Type:</b> CME 45 Trackmount	<b>Bearing:</b>	<b>Date Logged:</b> Dec 03, 2024	<b>Logged by:</b> TV/DC
<b>Driller:</b> Jamie	<b>Hole Diam (mm):</b> 83	<b>Inclination:</b> 90.00°	<b>Date Checked:</b>	<b>Reviewed by:</b> TWB

Elevation (m)	Depth (m)	Method	Graphic Log	Soil Description	Run Recovery	Sample Type	Sample Number	Recovery %	Blows	SPT N-Value	MC (%) PL & LL (%) SPT N-value PP (kPa) Field Peak Vane (kPa) Field Rem. Vane (kPa)	Particle Size GR SA SI CL (FINES)	Lab Testing	
				Topsoil		SPT	SS1	63	1-3-4-5	7				
				SILTY CLAY (CL): trace sand, low plasticity, firm to stiff, greyish brown, oxidation staining to 1.5 m, containing organics and rootlets to 0.7 m, reworked to 0.7 m		SPT	SS2	100	4-5-4-7	9				
						SPT	SS3	100	5-6-6-6	12				
						SPT	SS4	100	4-3-3-2	6				
						SPT	SS5	100	1-5-50	55				
98.0	1.0	152 mm outside dia. Hollow Stem Augers												
97.0	2.0													
96.0	3.0					2.85 m END OF BOREHOLE Auger Refusal								
95.0	4.0													
94.0	5.0													
93.0	6.0													
92.0	7.0													
91.0	8.0													

Notes:  
1. Borehole dry upon completion of drilling

# BOREHOLE RECORD

**FY24-4**

<b>Client:</b> Brookfield BRP	<b>Final Depth:</b> 1.05 m	<b>Easting:</b> 340,502.04 m
<b>Project:</b> South March BESS	<b>Coord. System:</b> NAD83 / MTM zone 9N	<b>Northing:</b> 5,028,617.03 m
<b>Project No:</b> H375035	<b>Location:</b>	<b>Vertical Datum:</b> CGVD2013
<b>Elevation:</b> 100.10 m		

<b>Contractor:</b> OGS	<b>Rig Type:</b> CME 45 Trackmount	<b>Bearing:</b>	<b>Date Logged:</b> Dec 03, 2024	<b>Logged by:</b> TV/DC
<b>Driller:</b> Jamie	<b>Hole Diam (mm):</b> 83	<b>Inclination:</b> 90.00°	<b>Date Checked:</b>	<b>Reviewed by:</b> TWB

Elevation (m)	Depth (m)	Method	Graphic Log	Soil Description						Run Recovery	Sample Type	Sample Number	Recovery %	Blows	SPT N-Value	MC (%) PL & LL (%) SPT N-value PP (kPa) Field Peak Vane (kPa) Field Rem. Vane (kPa)	Particle Size GR SA SI CL (FINES)	Lab Testing
				NAME (SYMBOL): gradational components including plasticity or particle characteristics (size, angularity, shape), consistency/density, colour, moisture, additional description, (GEOLOGICAL FORMATION).														
		152 mm outside dia. Hollow Stem Augers	Topsoil															
			SILTY SAND (SM): trace gravel, medium grained, poorly graded, compact, moist, brown						SPT	SS1	63	1-3-10.8	13					
99.0	1.0		SANDY SILTY CLAY: trace gravel, low plasticity, w>PL, brown, oxidation staining, reworked						SPT	SS2	33	5-19-50	69				N>50	
			1.05 m END OF BOREHOLE Auger Refusal															
98.0	2.0																	
97.0	3.0																	
96.0	4.0																	
95.0	5.0																	
94.0	6.0																	
93.0	7.0																	
92.0	8.0																	

Notes:  
1. Borehole dry upon completion of drilling

# BOREHOLE RECORD

**FY24-5**

<b>Client:</b> Brookfield BRP	<b>Final Depth:</b> 7.55 m	<b>Easting:</b> 340,603.10 m
<b>Project:</b> South March BESS	<b>Coord. System:</b> NAD83 / MTM zone 9N	<b>Northing:</b> 5,028,675.83 m
<b>Project No:</b> H375035	<b>Location:</b>	<b>Elevation:</b> 99.22 m

<b>Contractor:</b> OGS	<b>Rig Type:</b> CME 45 Trackmount	<b>Bearing:</b>	<b>Date Logged:</b> Dec 02, 2024	<b>Logged by:</b> TV/DC
<b>Driller:</b> Jamie	<b>Hole Diam (mm):</b> 83	<b>Inclination:</b> 90.00°	<b>Date Checked:</b>	<b>Reviewed by:</b> TWB

Elevation (m)	Depth (m)	Method	Graphic Log	Soil Description	Run Recovery	Sample Type	Sample Number	Recovery %	Blows	SPT N-Value	Particle Size	Lab Testing
			Topsoil									
98.0	1.0	152 mm outside dia. Hollow Stem Augers	SILTY CLAY (CL): trace sand, low plasticity, w>PL, soft to stiff, greyish brown, moist, containing rootlets to 0.6 m, reworked		SPT	SS1	50	1-3-4-3	7	7		
				SPT	SS2	100	3-3-4-5	7				
				SPT	SS3	100	6-6-6-6	12				
97.0	2.0			SPT	SS4	100	4-3-3-5	6				
				SPT	SS5	100	3-2-4-4	6				
				SPT	SS6	100	2-2-3-4	5				
95.0	4.0			SPT	SS7	100	3-2-3-3	5				
				SPT	SS8	100	1-2-1-1	3				
94.0	5.0			SPT	SS9	100	1-1-1-1	2				
				SPT	SS10	100	1-1-1-1	2				
93.0	6.0											
92.0	7.0											
91.0	8.0		Granitic Gneiss Bedrock	7.55 m END OF BOREHOLE Auger Refusal								

Notes: 1. Water level in open borehole measured at a depth of 1.3m below ground surface upon completion of drilling.  
 2. Shelby Tube (T.O) sample taken at a depth of 4.6m - 5.2m below ground surface in a borehole advanced in adjacent to Borehole FY24-5. Vane shear tests performed in the same adjacent borehole.

# BOREHOLE RECORD

**FY24-6**

<b>Client:</b> Brookfield BRP	<b>Final Depth:</b> 3.55 m	<b>Easting:</b> 340,644.90 m
<b>Project:</b> South March BESS	<b>Coord. System:</b> NAD83 / MTM zone 9N	<b>Northing:</b> 5,028,607.61 m
<b>Project No:</b> H375035	<b>Location:</b>	<b>Elevation:</b> 100.43 m

<b>Contractor:</b> OGS	<b>Rig Type:</b> CME 45 Trackmount	<b>Bearing:</b>	<b>Date Logged:</b> Dec 01, 2024	<b>Logged by:</b> TV/DC
<b>Driller:</b> Jamie	<b>Hole Diam (mm):</b> 83	<b>Inclination:</b> 90.00°	<b>Date Checked:</b>	<b>Reviewed by:</b> TWB

Elevation (m)	Depth (m)	Method	Graphic Log	Soil Description	Run Recovery	SPT	Sample Type	Sample Number	Recovery %	Blows	SPT N-Value	Particle Size	Lab Testing
			Topsoil										
		152 mm outside dia. Hollow Stem Augers	SILTY CLAY (CL): trace sand, low plasticity, w>PL, firm to stiff, greyish brown, moist, oxidation staining to 0.6 m, containing rootlets to 0.6 m, reworked			SPT	SS1	58	1-1-4-5	5			
99.0	1.0					SPT	SS2	100	3-4-5-7	9			
98.0	2.0					SPT	SS3	100	3-4-3-7	7			
97.0	3.0		SILTY CLAY TILL (CL): trace sand, trace gravel, low plasticity, w~PL, greyish brown, moist			SPT	SS4	100	3-3-4-3	7			
			3.55 m END OF BOREHOLE Auger Refusal			SPT	SS5	91	11-8-20-50/100 hmt	28			
96.0	4.0												
95.0	5.0												
94.0	6.0												
93.0	7.0												
92.0	8.0												

**Notes:**  
 1. Water level in open borehole at a depth of 1.1m below ground surface upon completion of drilling

Sheet 1 of 2

# BOREHOLE RECORD

**FY24-7**

<b>Client:</b> Brookfield BRP	<b>Final Depth:</b> 4.65 m	<b>Easting:</b> 340,719.30 m
<b>Project:</b> South March BESS	<b>Coord. System:</b> NAD83 / MTM zone 9N	<b>Northing:</b> 5,028,576.59 m
<b>Project No:</b> H375035	<b>Location:</b>	<b>Elevation:</b> 103.20 m

<b>Contractor:</b> OGS	<b>Rig Type:</b> CME 45 Trackmount	<b>Bearing:</b>	<b>Date Logged:</b> Dec 01, 2024	<b>Logged by:</b> TV/DC
<b>Driller:</b> Jamie	<b>Hole Diam (mm):</b> 83	<b>Inclination:</b> 90.00°	<b>Date Checked:</b>	<b>Reviewed by:</b> TWB

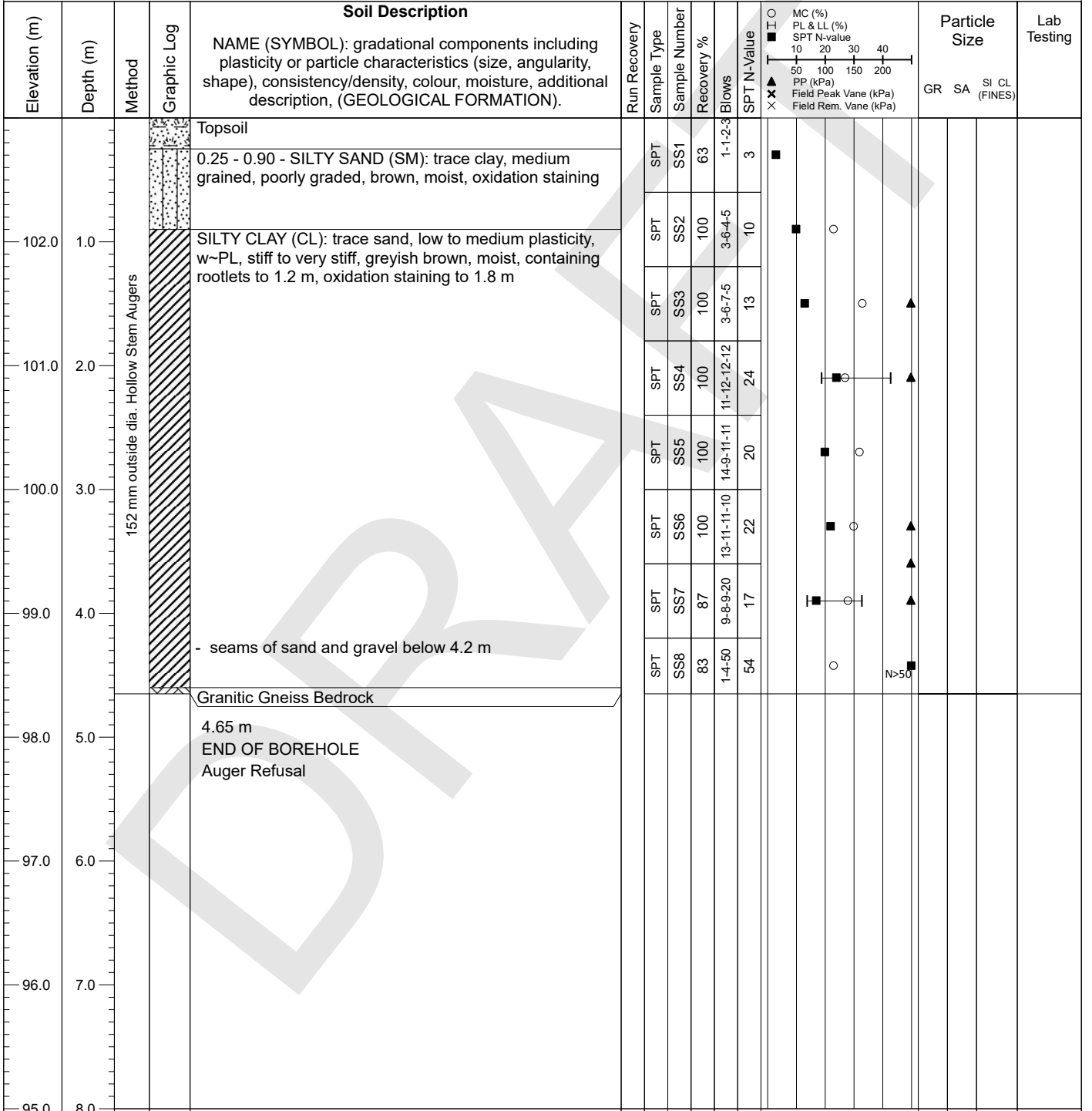

Notes:  
1. Borehole dry upon completion of drilling

# BOREHOLE RECORD

**FY24-8**

<b>Client:</b> Brookfield BRP	<b>Final Depth:</b> 0.75 m	<b>Easting:</b> 340,657.27 m
<b>Project:</b> South March BESS	<b>Coord. System:</b> NAD83 / MTM zone 9N	<b>Northing:</b> 5,028,511.78 m
<b>Project No:</b> H375035	<b>Location:</b>	<b>Vertical Datum:</b> CGVD2013
<b>Elevation:</b> 102.89 m		

<b>Contractor:</b> OGS	<b>Rig Type:</b> CME 45 Trackmount	<b>Bearing:</b>	<b>Date Logged:</b> Dec 03, 2024	<b>Logged by:</b> TV/DC
<b>Driller:</b> Jamie	<b>Hole Diam (mm):</b> 83	<b>Inclination:</b> 90.00°	<b>Date Checked:</b>	<b>Reviewed by:</b> TWB

Elevation (m)	Depth (m)	Method	Graphic Log	Soil Description						Particle Size	Lab Testing
				NAME (SYMBOL): gradational components including plasticity or particle characteristics (size, angularity, shape), consistency/density, colour, moisture, additional description, (GEOLOGICAL FORMATION).	Run Recovery	Sample Type	Sample Number	Recovery %	Blows		
100.0	1.0	152 mm outside dia. Hollow Stem	<p>Topsoil</p> <p>SILTY CLAY (CL): trace sand, low plasticity, w&gt;PL, brown, moist, containing rootlets, reworked</p>	5	SPT	15	100	25	6		
93.0	8.0		<p>0.75 m END OF BOREHOLE Auger and Split-Spoon Refusal</p>								

Notes:

# BOREHOLE RECORD

**FY24-9**

<b>Client:</b> Brookfield BRP	<b>Final Depth:</b> 3.60 m	<b>Easting:</b> 340,667.29 m
<b>Project:</b> South March BESS	<b>Coord. System:</b> NAD83 / MTM zone 9N	<b>Northing:</b> 5,028,663.08 m
<b>Project No:</b> H375035	<b>Location:</b>	<b>Elevation:</b> 100.20 m

<b>Contractor:</b> OGS	<b>Rig Type:</b> CME 45 Trackmount	<b>Bearing:</b>	<b>Date Logged:</b> Dec 03, 2024	<b>Logged by:</b> TV/DC
<b>Driller:</b> Jamie	<b>Hole Diam (mm):</b> 83	<b>Inclination:</b> 90.00°	<b>Date Checked:</b>	<b>Reviewed by:</b> TWB

Elevation (m)	Depth (m)	Method	Graphic Log	Soil Description NAME (SYMBOL): gradational components including plasticity or particle characteristics (size, angularity, shape), consistency/density, colour, moisture, additional description, (GEOLOGICAL FORMATION).	Run Recovery	Sample Type	Sample Number	Recovery %	Blows	SPT N-Value	Particle Size				Lab Testing	
											GR	SA	SI	CL (FINES)		
99.0	1.0	152 mm outside dia. Hollow Stem Augers		Topsoil		SPT	SS1	88	1-2-5-6	7						
				SILTY CLAY (CL): trace sand, low plasticity, w>PL, brown, moist, oxidation staining		SPT	SS2	100	8-14-12-13	26						
98.0	2.0					SPT	SS3	100	14-14-14-50	28						
						SPT	SS4	100	19-15-14-12	29						
97.0	3.0					SPT	SS5	88	9-9-8-8	17						
						SPT	SS6	75	5-4-3-50	7						
				- seams of sand and gravel below 3.1 m												
				End of hole at 3.60 m.												
96.0	4.0															
95.0	5.0															
94.0	6.0															
93.0	7.0															
92.0	8.0															

Notes:

Sheet 1 of 1

# Appendix B

## Geotechnical Laboratory Testing

DRAFT

# Particle Size Distribution (Gradation) of Soils Using Sieve and Hydrometer Analysis



ASTM D6913-17 and D7928-17

Date: January 13.2025

Project Number: H375142

Project: Fitzroy BESS

Brookfield BRP

Brookfield Place, Suite 100, 181 Bay St. Toronto ON. M5J

2T3

Attn: Ted Beadle

<b>Sample</b>	SS3	<b>Depth</b>	5ft - 7ft
<b>Source</b>	FY24-1		

Sieve (mm)	% Passing	Sieve (mm)	% Passing	Size (mm)	% Passing
75	100.0	4.75	100.0	0.0350	94.5
63	100.0	2	100.0	0.0255	89.6
53	100.0	0.850	99.9	0.0166	84.6
37.5	100.0	0.425	99.8	0.0099	78.7
26.5	100.0	0.250	99.6	0.0071	74.8
19	100.0	0.106	99.1	0.0052	70.9
13.2	100.0	0.075	98.4	0.0027	62.0
9.5	100.0			0.0012	52.2

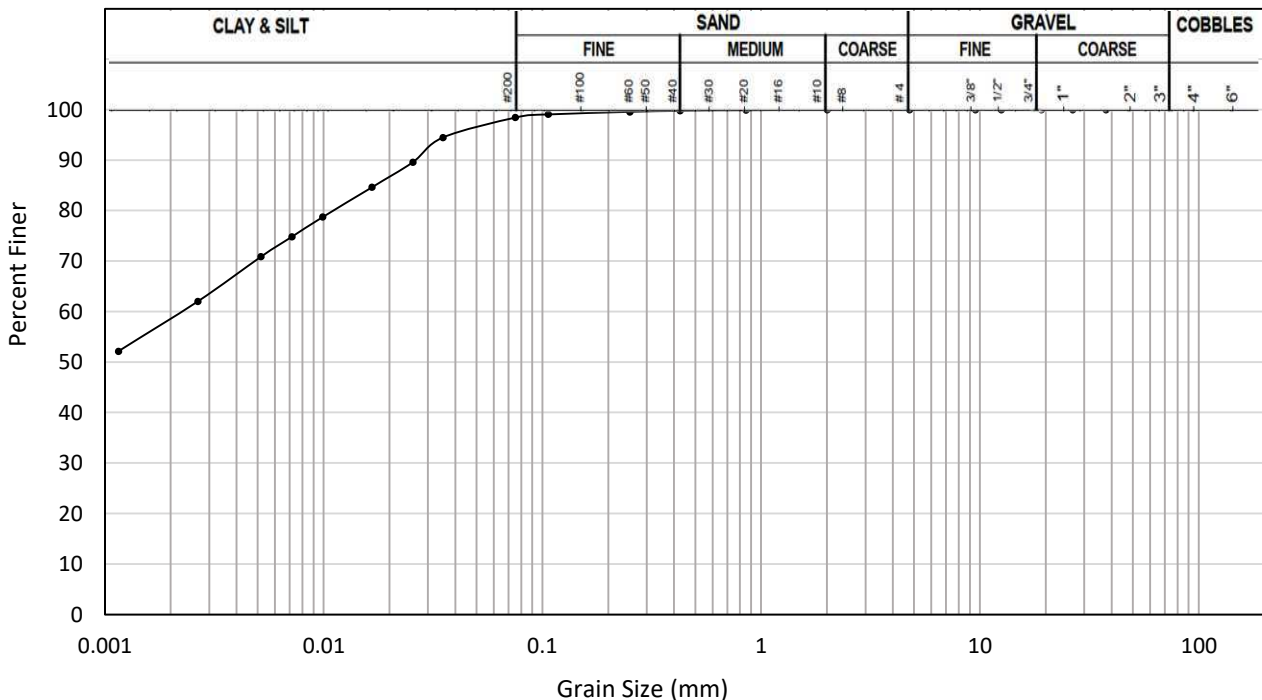

**Comments:** Whole sample, tested as received. 100% passing the 2mm sieve.

**Reported By:** D. Cuellar, Technician  
**Reviewed By:** R.Serluca, Lab Manager

**Date:** January 13.2025  
**Date:** February 5.2025

Notice: The test data given herein pertain to the sample provide, and may not be applicable to other production zones/periods. This report constitutes a testing service only. Interpretation of the data given here may be provided upon request.

Suite 300, 4342 Queen St, Niagara Falls, Ontario, Canada, L2E 7J7 Tel:1 (905) 374 5200 [www.hatch.com](http://www.hatch.com).

©Hatch 2017 All rights reserved, including all rights relating to the use of this document and its contents.

# Liquid Limit, Plastic Limit and Plasticity Index of Soils.



## ASTM D4318-17 Method A

Date: January 13.2025

Project Number: H375142

Project: Fitzroy BESS

Brookfield BRP

Brookfield Place, Suite 100, 181 Bay St. Toronto

ON. M5J 2T3

Attn: Ted Beadle

<b>Sample</b>	SS3	<b>Depth</b>	5ft - 7ft
<b>Source</b>	FY24-1		

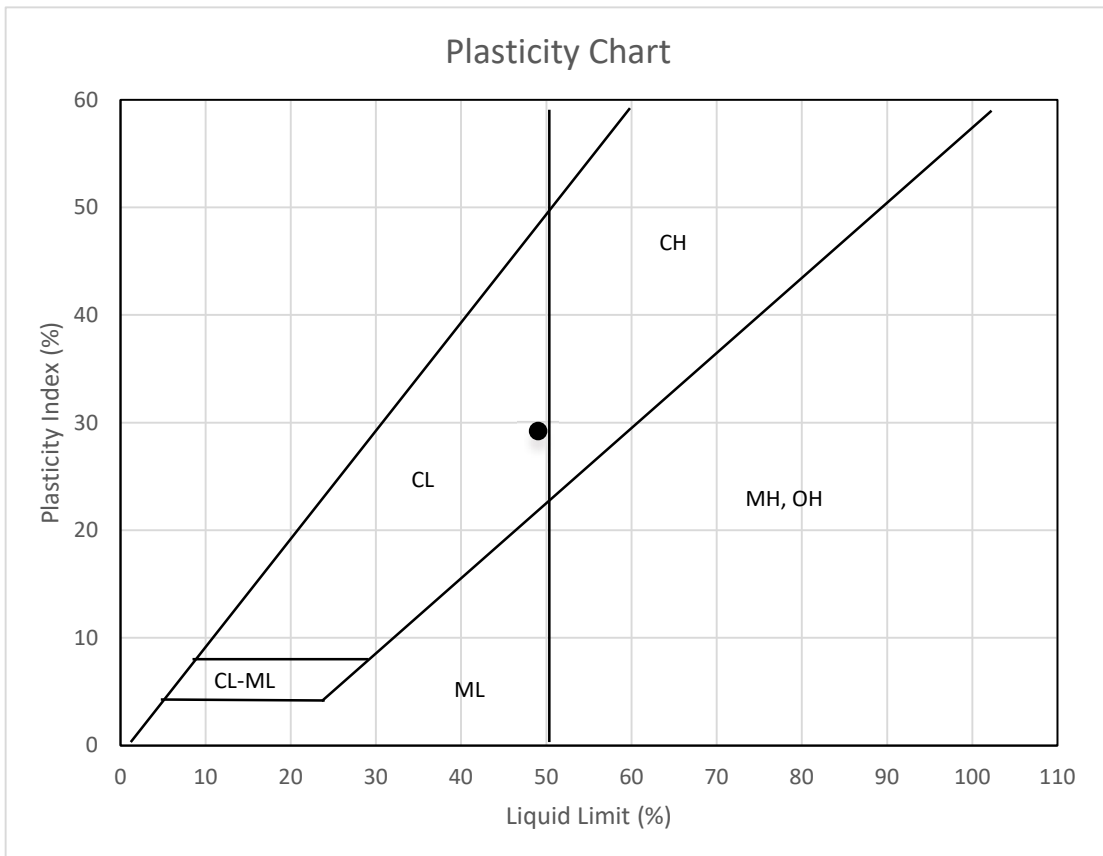

Liquid Limit	49%
Plastic Limit	20%
Plasticity Index	29%

**Comments:** Silty-Clay, grey.

**Reported By:** D. Cuellar, Technician

**Date:** January 13.2025

**Reviewed By:** R. Serluca, Lab Manager

**Date:** February 5. 2025

Notice: The test data given herein pertain to the sample provide, and may not be applicable to other production zones/periods. This report constitutes a testing service only. Interpretation of the data given here may be provided upon request.

Suite 300, 4342 Queen St, Niagara Falls, Ontario, Canada, L2E 7J7 Tel:1 (905) 374 5200 [www.hatch.com](http://www.hatch.com).

©Hatch 2017 All rights reserved, including all rights relating to the use of this document and its contents.

# Liquid Limit, Plastic Limit and Plasticity Index of Soils.



## ASTM D4318-17 Method A

Date: January 13.2025

Project Number: H375142

Project: Fitzroy BESS

Brookfield BRP

Brookfield Place, Suite 100, 181 Bay St. Toronto

ON. M5J 2T3

Attn: Ted Beadle

<b>Sample</b>	SS5	<b>Depth</b>	10ft - 12ft
<b>Source</b>	FY24-1		

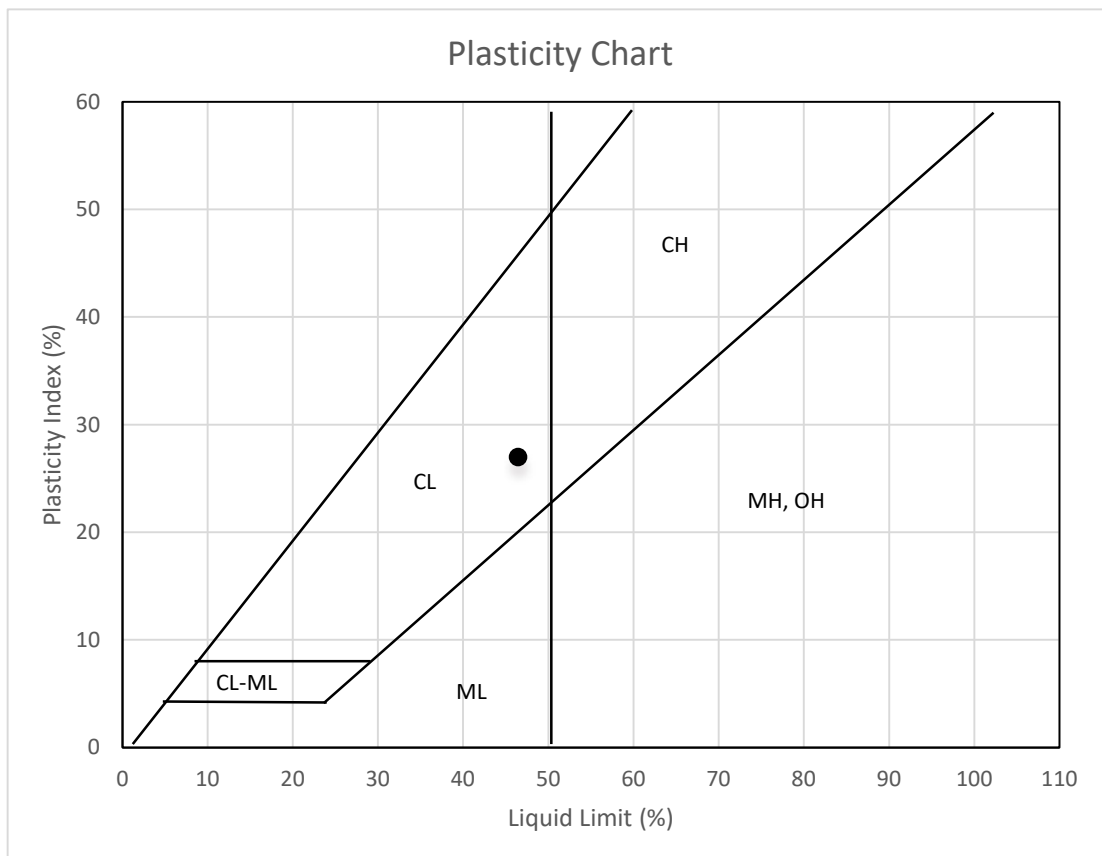

Liquid Limit	46%
Plastic Limit	20%
Plasticity Index	27%

**Comments:** Silty-Clay, grey.

**Reported By:** D. Cuellar, Technician

**Date:** January 13.2025

**Reviewed By:** R. Serluca, Lab Manager

**Date:** February 5. 2025

Notice: The test data given herein pertain to the sample provide, and may not be applicable to other production zones/periods. This report constitutes a testing service only. Interpretation of the data given here may be provided upon request.

Suite 300, 4342 Queen St, Niagara Falls, Ontario, Canada, L2E 7J7 Tel:1 (905) 374 5200 [www.hatch.com](http://www.hatch.com).

©Hatch 2017 All rights reserved, including all rights relating to the use of this document and its contents.

# Liquid Limit, Plastic Limit and Plasticity Index of Soils.



## ASTM D4318-17 Method A

Date: January 13.2025

Project Number: H375142

Project: Fitzroy BESS

Brookfield BRP

Brookfield Place, Suite 100, 181 Bay St. Toronto

ON. M5J 2T3

Attn: Ted Beadle

<b>Sample</b>	SS2	<b>Depth</b>	2ft - 4ft
<b>Source</b>	FY24-3		

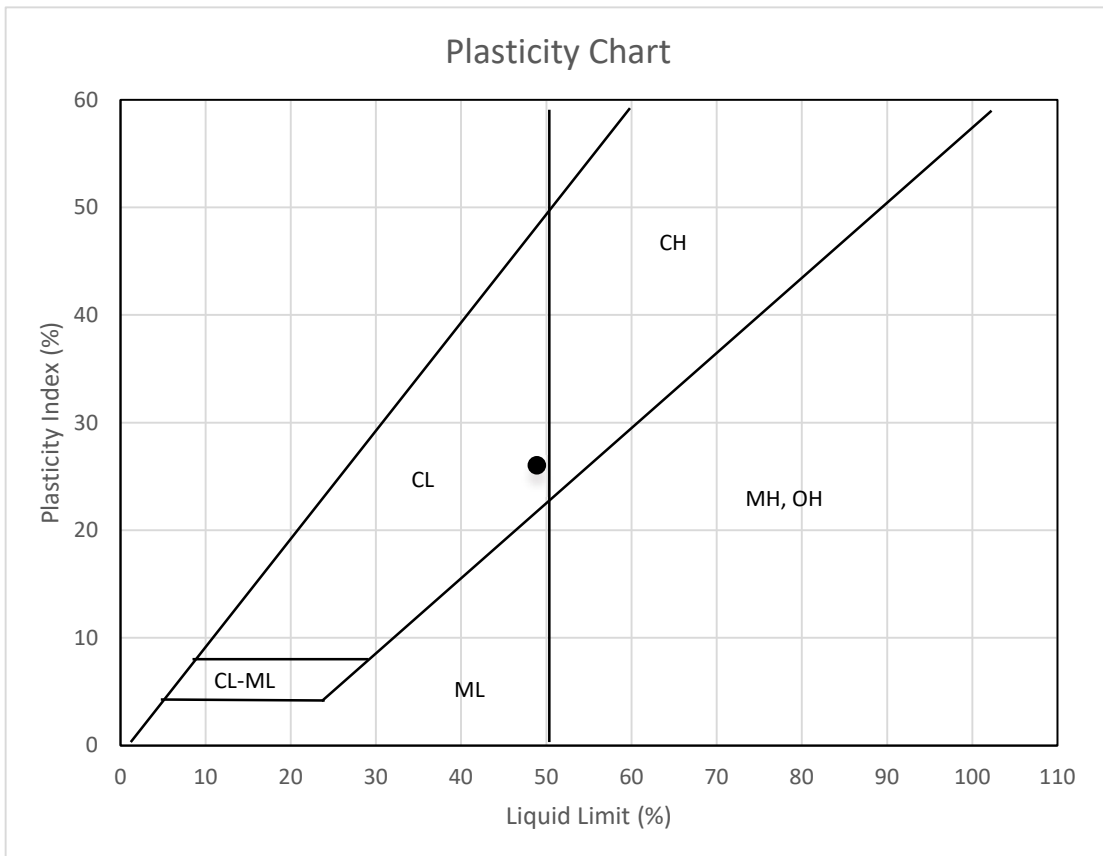

Liquid Limit	49%
Plastic Limit	23%
Plasticity Index	26%

**Comments:** Silty-Clay, grey.

**Reported By:** D. Cuellar, Technician

**Date:** January 13.2025

**Reviewed By:** R. Serluca, Lab Manager

**Date:** February 5. 2025

Notice: The test data given herein pertain to the sample provide, and may not be applicable to other production zones/periods. This report constitutes a testing service only. Interpretation of the data given here may be provided upon request.

Suite 300, 4342 Queen St, Niagara Falls, Ontario, Canada, L2E 7J7 Tel:1 (905) 374 5200 [www.hatch.com](http://www.hatch.com).

©Hatch 2017 All rights reserved, including all rights relating to the use of this document and its contents.

# Liquid Limit, Plastic Limit and Plasticity Index of Soils.



## ASTM D4318-17 Method A

Date: January 13.2025

Project Number: H375142

Project: Fitzroy BESS

Brookfield BRP

Brookfield Place, Suite 100, 181 Bay St. Toronto

ON. M5J 2T3

Attn: Ted Beadle

<b>Sample</b>	SS4	<b>Depth</b>	6ft - 8ft
<b>Source</b>	FY24-5		

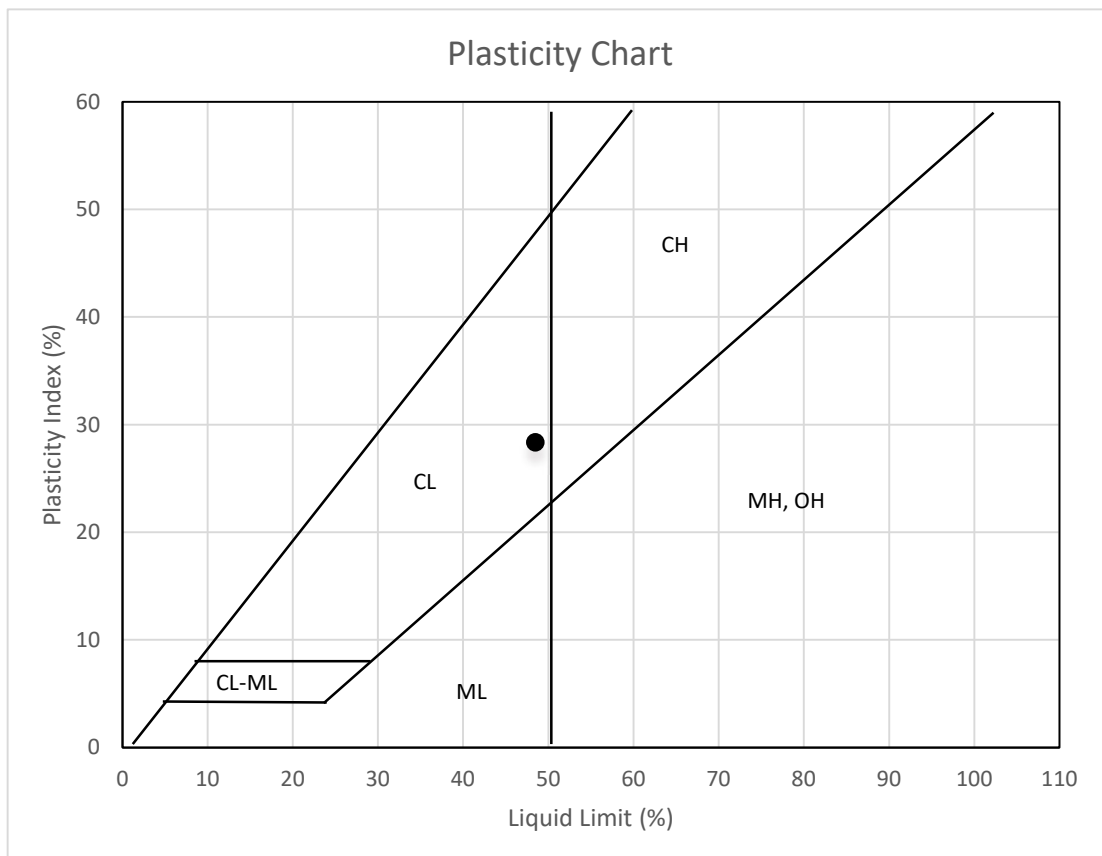

Liquid Limit	48%
Plastic Limit	20%
Plasticity Index	28%

**Comments:** Silty-Clay, grey.

**Reported By:** D. Cuellar, Technician

**Date:** January 13.2025

**Reviewed By:** R. Serluca, Lab Manager

**Date:** February 5. 2025

Notice: The test data given herein pertain to the sample provide, and may not be applicable to other production zones/periods. This report constitutes a testing service only. Interpretation of the data given here may be provided upon request.

Suite 300, 4342 Queen St, Niagara Falls, Ontario, Canada, L2E 7J7 Tel:1 (905) 374 5200 [www.hatch.com](http://www.hatch.com).

©Hatch 2017 All rights reserved, including all rights relating to the use of this document and its contents.

# Liquid Limit, Plastic Limit and Plasticity Index of Soils.



## ASTM D4318-17 Method A

Date: January 13.2025

Project Number: H375142

Project: Fitzroy BESS

Brookfield BRP

Brookfield Place, Suite 100, 181 Bay St. Toronto

ON. M5J 2T3

Attn: Ted Beadle

<b>Sample</b>	SS10	<b>Depth</b>	18ft - 20ft
<b>Source</b>	FY24-5		

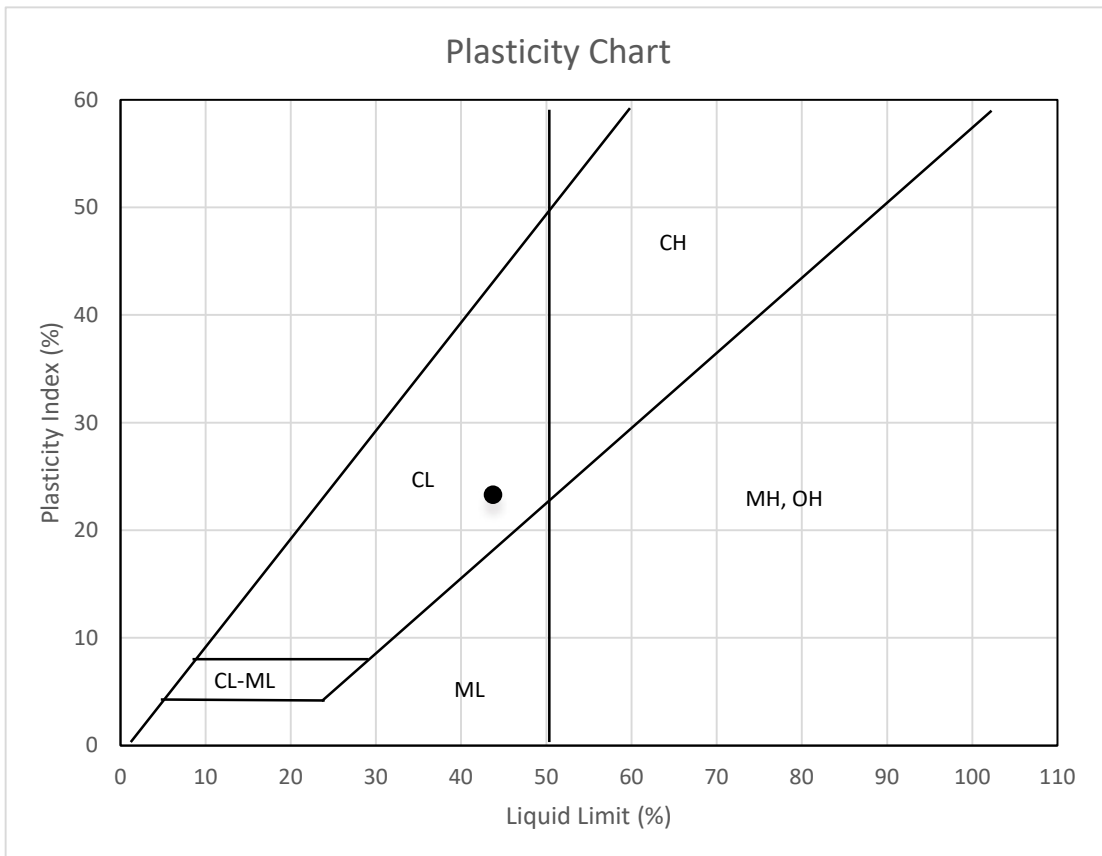

Liquid Limit	44%
Plastic Limit	20%
Plasticity Index	23%

**Comments:** Silty-Clay, grey.

**Reported By:** D. Cuellar, Technician

**Date:** January 13.2025

**Reviewed By:** R. Serluca, Lab Manager

**Date:** February 5. 2025

Notice: The test data given herein pertain to the sample provide, and may not be applicable to other production zones/periods. This report constitutes a testing service only. Interpretation of the data given here may be provided upon request.

Suite 300, 4342 Queen St, Niagara Falls, Ontario, Canada, L2E 7J7 Tel:1 (905) 374 5200 [www.hatch.com](http://www.hatch.com).

©Hatch 2017 All rights reserved, including all rights relating to the use of this document and its contents.

# Liquid Limit, Plastic Limit and Plasticity Index of Soils.



## ASTM D4318-17 Method A

Date: January 13.2025

Project Number: H375142

Project: Fitzroy BESS

Brookfield BRP

Brookfield Place, Suite 100, 181 Bay St. Toronto

ON. M5J 2T3

Attn: Ted Beadle

<b>Sample</b>	SS4	<b>Depth</b>	7.5ft - 9.5ft
<b>Source</b>	FY24-7		

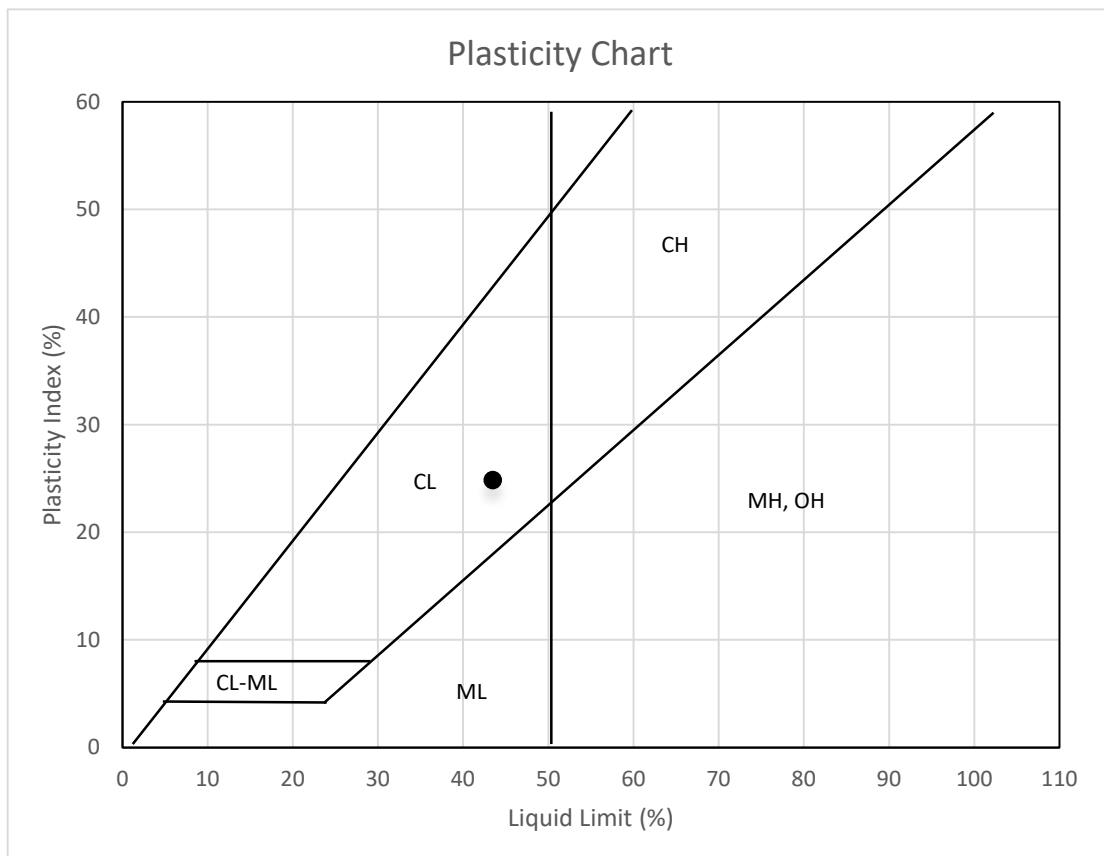

Liquid Limit	43%
Plastic Limit	19%
Plasticity Index	25%

**Comments:** Silty-Clay, grey.

**Reported By:** D. Cuellar, Technician

**Date:** January 13.2025

**Reviewed By:** R. Serluca, Lab Manager

**Date:** February 5. 2025

Notice: The test data given herein pertain to the sample provide, and may not be applicable to other production zones/periods. This report constitutes a testing service only. Interpretation of the data given here may be provided upon request.

Suite 300, 4342 Queen St, Niagara Falls, Ontario, Canada, L2E 7J7 Tel:1 (905) 374 5200 www.hatch.com.

©Hatch 2017 All rights reserved, including all rights relating to the use of this document and its contents.

# Liquid Limit, Plastic Limit and Plasticity Index of Soils.



## ASTM D4318-17 Method A

Date: January 13.2025

Project Number: H375142

Project: Fitzroy BESS

Brookfield BRP

Brookfield Place, Suite 100, 181 Bay St. Toronto

ON. M5J 2T3

Attn: Ted Beadle

<b>Sample</b>	SS7	<b>Depth</b>	15ft - 17ft
<b>Source</b>	FY24-7		

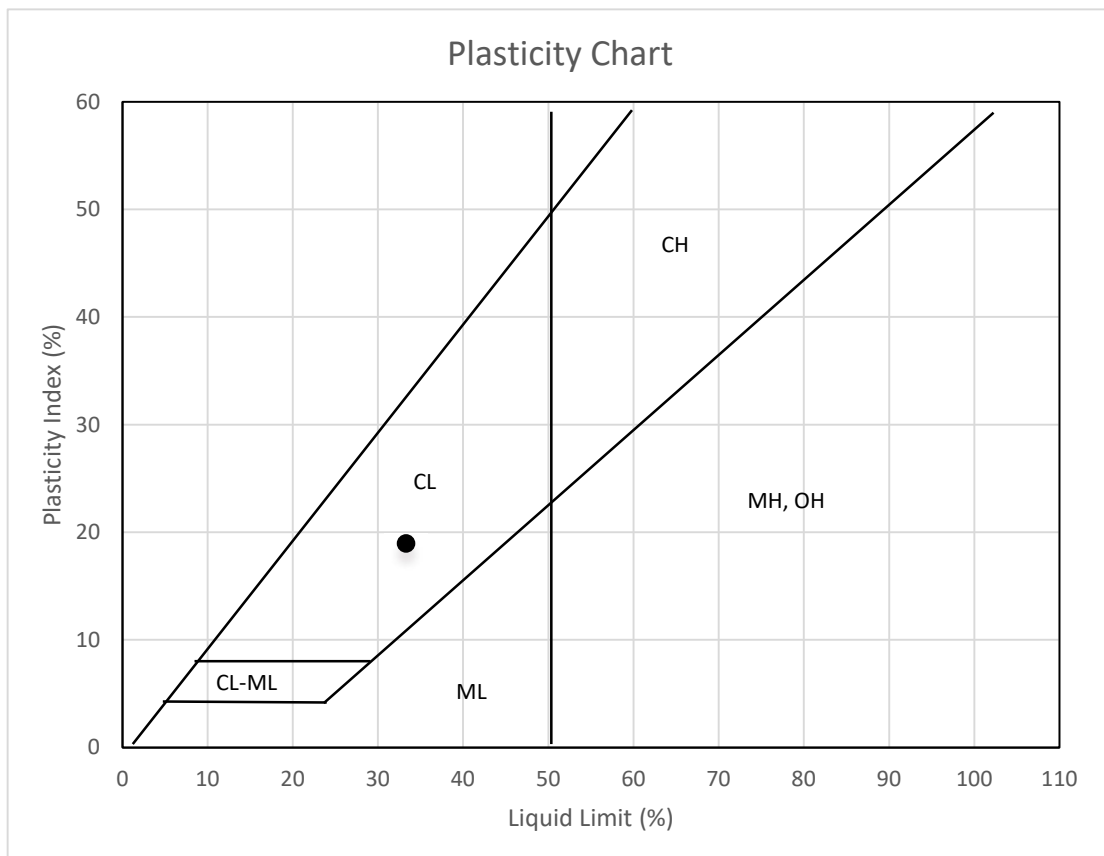

Liquid Limit	33%
Plastic Limit	14%
Plasticity Index	19%

**Comments:** Silty-Clay, grey.

**Reported By:** D. Cuellar, Technician

**Date:** January 13.2025

**Reviewed By:** R. Serluca, Lab Manager

**Date:** February 5. 2025

Notice: The test data given herein pertain to the sample provide, and may not be applicable to other production zones/periods. This report constitutes a testing service only. Interpretation of the data given here may be provided upon request.

Suite 300, 4342 Queen St, Niagara Falls, Ontario, Canada, L2E 7J7 Tel:1 (905) 374 5200 [www.hatch.com](http://www.hatch.com).

©Hatch 2017 All rights reserved, including all rights relating to the use of this document and its contents.

# Grain Size Distribution ASTM D422-16

Job No. : **15599**

Project: H/375142/999-0101  
 Reported To: Hatch

Test Date: 1/7/25  
 Report Date: 1/14/25

	Location / Boring No.	Sample No.	Depth (ft)	Sample Type	Soil Classification
*	FY24-1		1-5	Bulk	Lean Clay (CL)
●					
◇					

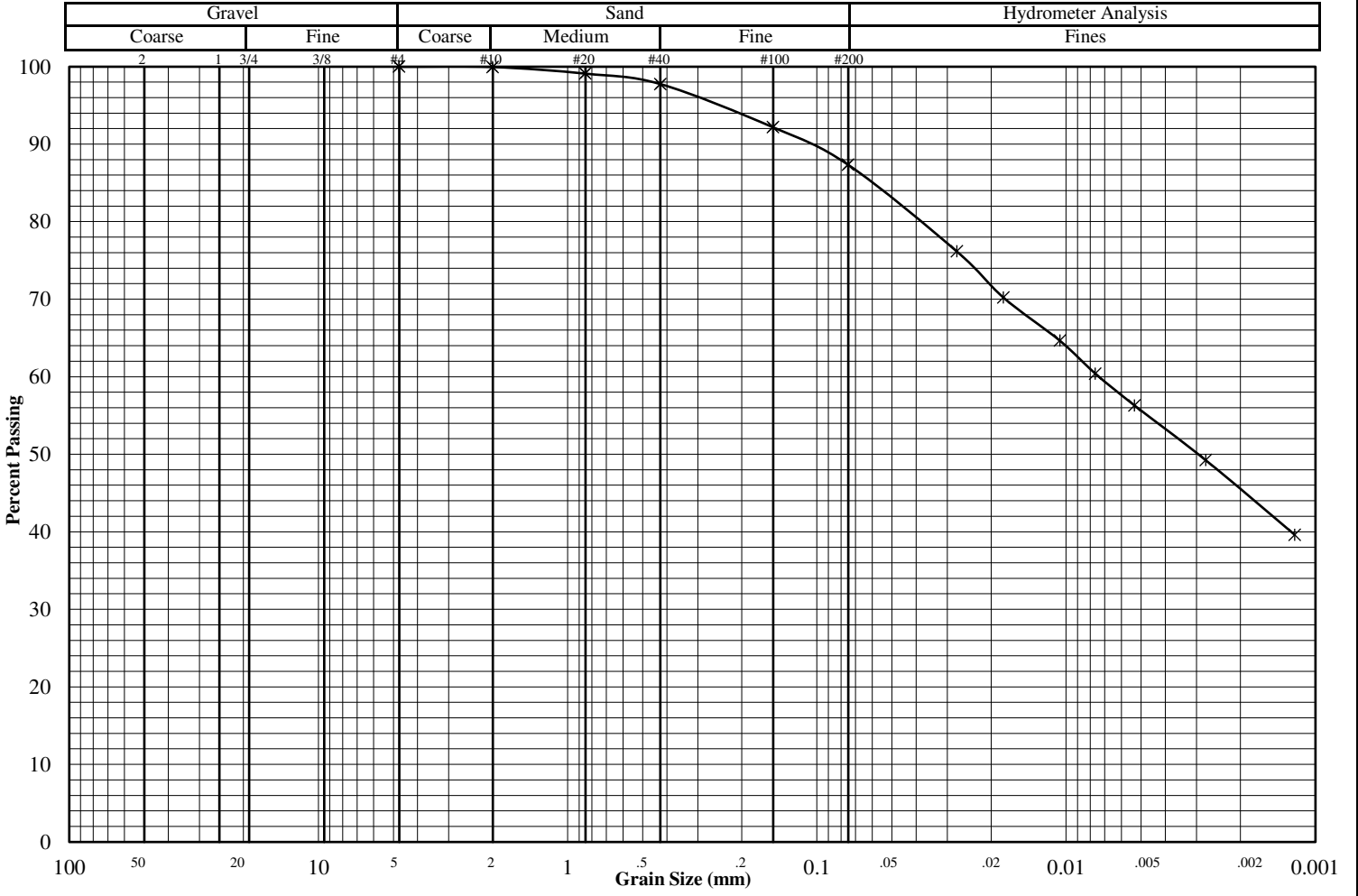

**Additional Results**

	*	●	◇
Liquid Limit	38		
Plastic Limit	18		
Plasticity Index <small>ASTM: D4318</small>	20		
Water Content <small>ASTM: D2216</small>			
Dry Density (pcf) <small>ASTM: D7263</small>			
Specific Gravity <small>ASTM: D854</small>	2.71*		
Porosity			
Organic Content <small>ASTM: D2974</small>			
pH <small>ASTM: D4972 Method B</small>			

	Percent Passing		
	*	●	◇
Mass (g)	17885.0		
2"			
1.5"			
1"			
3/4"			
3/8"			
#4	100.0		
#10	100.0		
#20	99.1		
#40	97.8		
#100	92.2		
#200	87.3		

	*	●	◇
D <sub>60</sub>			
D <sub>30</sub>			
D <sub>10</sub>			
C <sub>u</sub>			
C <sub>c</sub>			

Remarks:

(\* = assumed)

# Appendix C

## Advanced Geotechnical Laboratory Testing

DRAFT

# Unconsolidated Undrained Triaxial Compression

## Test on Cohesive Soils

### ASTM D2850-15



Date: January 17, 2025  
 Project Number: H/375142  
 Project: Fitzroy BESS

**Brookfield Renewable Power**  
 181 Bay St. Suite 300, Toronto, ON M5J 2T3  
 Attn: Ted Beadle

<b>Sample</b>	4.57 m to 5.17 m
<b>Source</b>	FY24-01

<b>Soil Type:</b> Silty-clay, trace sand and fine gravel, grey, moist.					
Specimen Average Height	7.797	cm	Specific Gravity	2.72	Assumed
Specimen Average Diameter	3.803	cm <sup>2</sup>	Liquid Limit	39	%
Initial Cross Sect. Area	11.298	cm <sup>2</sup>	Plastic Limit	18	%
Moist Specimen Mass	165.25	grams	Plasticity Index	21	%
Moist Density	1876.0	kg/m <sup>3</sup>	E <sup>m</sup> of Membrane	1200	kPa
Moisture Content	35.5	%			
Dry Density	1341.5	kg/m <sup>3</sup>	Confining Pressure - $\delta_3$	100	kPa
L/D Ratio	2.06		Strain Rate	0.20	% /min

<b>Axial Strain at Peak</b>	15 %	<b>Max. Deviator Stress ( <math>\delta^1 - \delta^3</math> )</b>	105.83 kPa
-----------------------------	------	--	------------

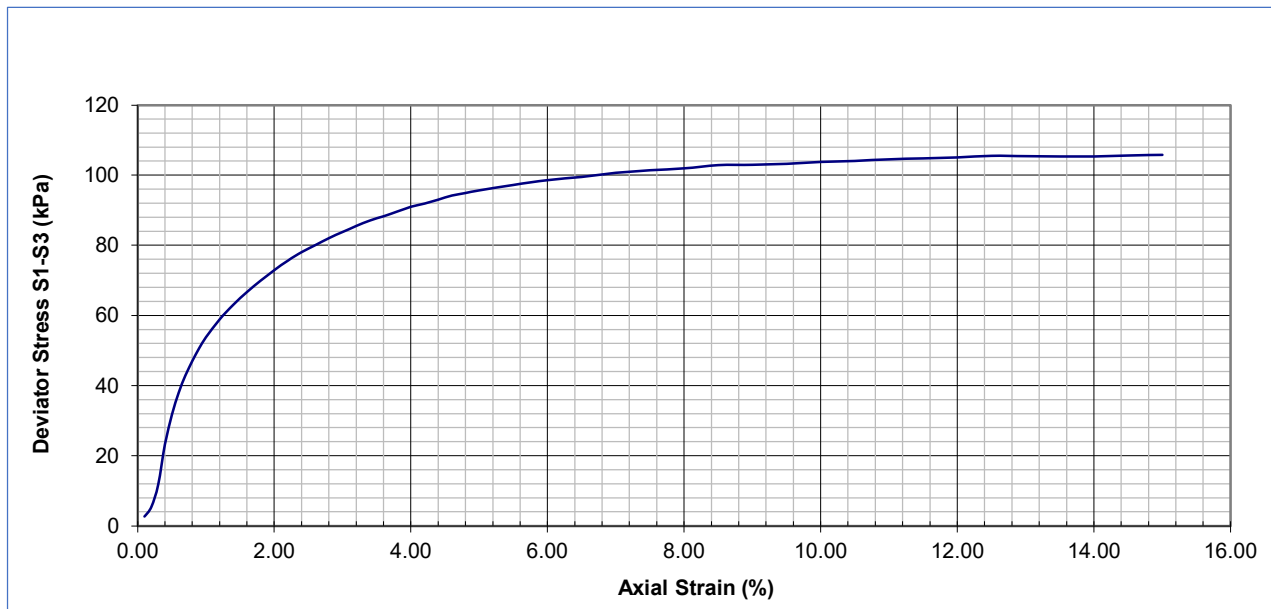

**Reported By:** R. Serluca . Lab Manager **Date:** January 22,2025  
**Reviewed By:** A. Touhidid **Date:** February 18,2025

Notice: The test data given herein pertain to the sample provide, and may not be applicable to other production zones/periods. This report constitutes a testing service only. Interpretation of the data given here may be provided upon request.

Suite 300, 4342 Queen St, Niagara Falls, Ontario, Canada, L2E 7J7 Tel:1 (905) 374 5200 www.hatch.com.

©Hatch 2017 All rights reserved, including all rights relating to the use of this document and its contents.

**Unconsolidated Undrained Triaxial Compression  
Test on Cohesive Soils  
ASTM D2850-15**



Date: January 17, 2025  
Project Number: H/375142  
Project: Fitzroy BESS

**Brookfield Renewable Power**  
181 Bay St. Suite 300, Toronto, ON M5J 2T3  
Attn: Ted Beadle

<b>Sample</b>	4.57 m to 5.17 m
<b>Source</b>	FY24-01

Photo Not Available

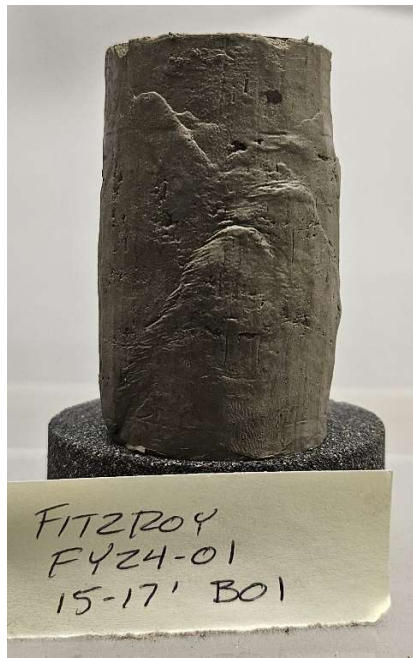

**BEFORE**

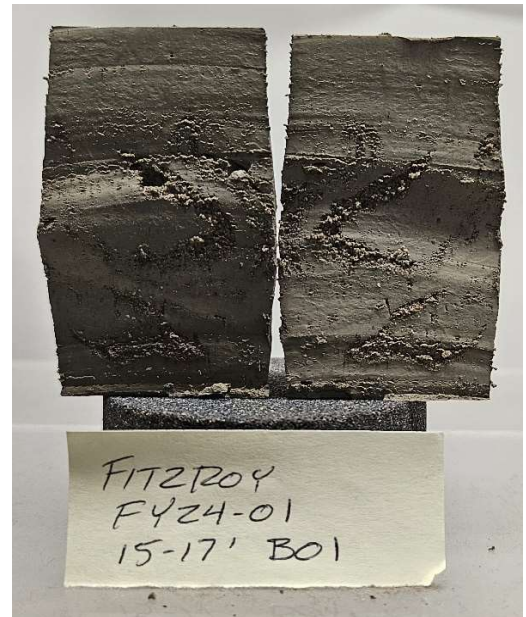

**AFTER**

**AFTER**

**NOTES:**

Strain rate slightly less than minimum suggested by ASTM was chosen to facilitate manual readings.

# Unconsolidated Undrained Triaxial Compression

## Test on Cohesive Soils

### ASTM D2850-15



Date: February 12, 2025  
 Project Number: H/375142  
 Project: Fitzroy BESS

**Brookfield Renewable Power**  
 181 Bay St. Suite 300, Toronto, ON M5J 2T3  
 Attn: Ted Beadle

<b>Sample</b>	4.57 m to 5.17 m
<b>Source</b>	FY24-05, Test 2

<b>Soil Type:</b> Silty clay, grey, moist.					
Specimen Average Height	7.810	cm	Specific Gravity	2.72	Assumed
Specimen Average Diameter	3.795	cm <sup>2</sup>	Liquid Limit	37	%
Initial Cross Sect. Area	11.313	cm <sup>2</sup>	Plastic Limit	18	%
Moist Specimen Mass	153.98	grams	Plasticity Index	19	%
Moist Density	1742.7	kg/m <sup>3</sup>	E <sup>m</sup> of Membrane	1200	kPa
Moisture Content	48.3	%			
Dry Density	1173.2	kg/m <sup>3</sup>	Confining Pressure - $\delta_3$	100	kPa
L/D ratio	2.06		Strain Rate	0.29	% /min

<b>Axial Strain at Peak</b>	3 %	<b>Max. Deviator Stress (<math>\delta^1 - \delta^3</math>)</b>	68.00 kPa
-----------------------------	-----	--	-----------

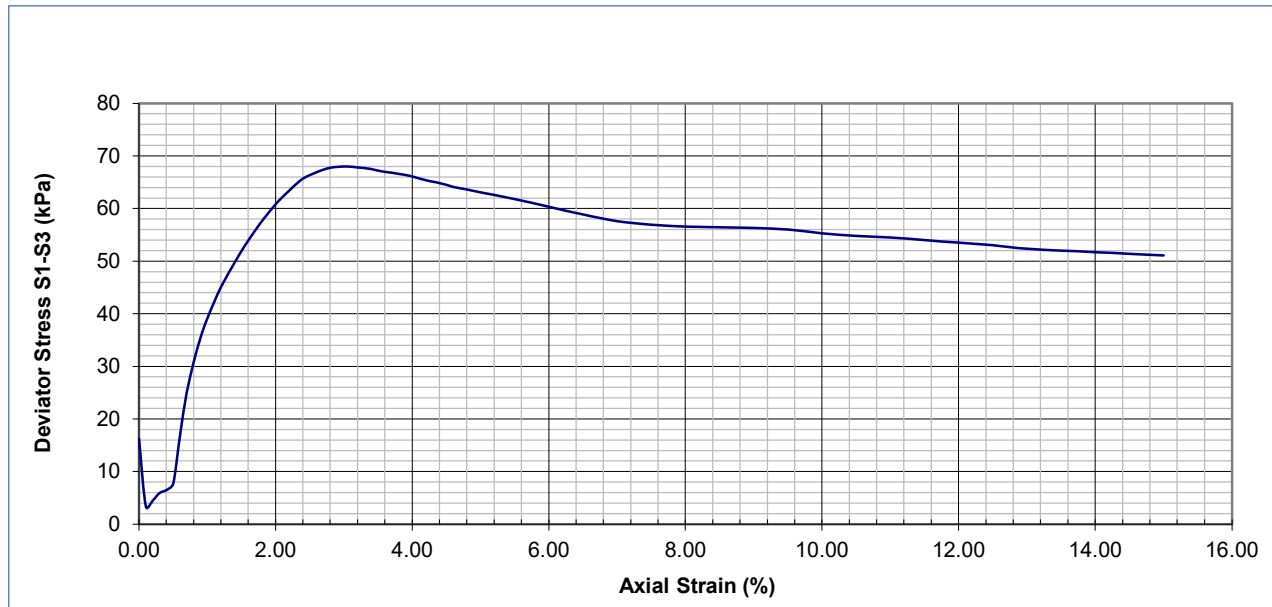

**Reported By:** R. Serluca . Lab Manager  
**Reviewed By:** A. Touhidi

**Date:** January 22, 2025  
**Date:** February 18, 2025

Notice: The test data given herein pertain to the sample provide, and may not be applicable to other production zones/periods. This report constitutes a testing service only. Interpretation of the data given here may be provided upon request.

Suite 300, 4342 Queen St, Niagara Falls, Ontario, Canada, L2E 7J7 Tel:1 (905) 374 5200 www.hatch.com.

©Hatch 2017 All rights reserved, including all rights relating to the use of this document and its contents.

**Unconsolidated Undrained Triaxial Compression  
Test on Cohesive Soils  
ASTM D2850-15**



Date: February 12.2025  
Project Number: H/375142  
Project: Fitzroy BESS

**Brookfield Renewable Power**  
181 Bay St. Suite 300, Toronto, ON M5J 2T3  
Attn: Ted Beadle

<b>Sample</b>	4.57 m to 5.17 m
<b>Source</b>	FY24-05, Test 2

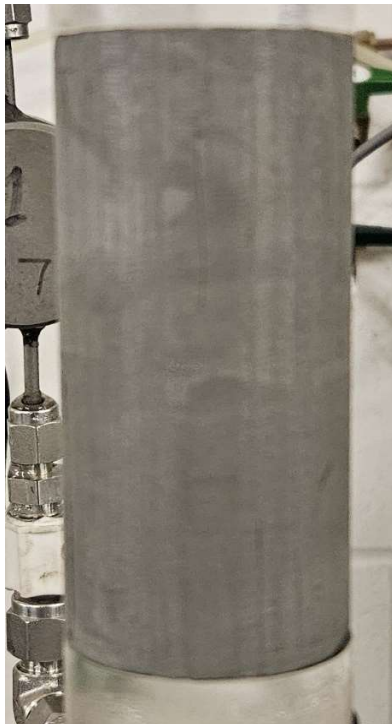

**BEFORE**



**AFTER**

**NOTES:**

Strain rate slightly less than minimum suggested ASTM was chosen to facilitate manual readings.

# Unconfined Compressive Strength of Cohesive Soils

ASTM D2166-24



Date: January 20, 2025  
 Project Number: H/375142  
 Project: Fitzroy BESS

**Brookfield Renewable Power**  
 181 Bay St. Suite 300, Toronto, ON M5J 2T3  
 Attn: Ted Beadle

<b>Sample</b>	4.57 m to 5.17 m
<b>Source</b>	FY24-05

<b>Soil Type:</b> Silty clay, grey, moist.					
Specimen Average Height	13.322	cm	Specific Gravity	2.72	Assumed
Specimen Average Diameter	5.888	cm	Liquid Limit	37	%
Initial Cross Sect. Area	27.226	cm <sup>2</sup>	Plastic Limit	18	%
Moist Specimen Mass	636.03	grams	Plasticity Index	19	%
Moist Density	1753.6	kg/m <sup>3</sup>			
Moisture Content	50.9	%			
Dry Density	1161.8	kg/m <sup>3</sup>			
L/D Ratio	2.26		Strain Rate	0.38	% /min

<b>Axial Strain at Peak</b>	3.2 %	<b>Max. Stress at Peak ( <math>\delta^1</math> )</b>	182.39 kPa
-----------------------------	-------	--	------------

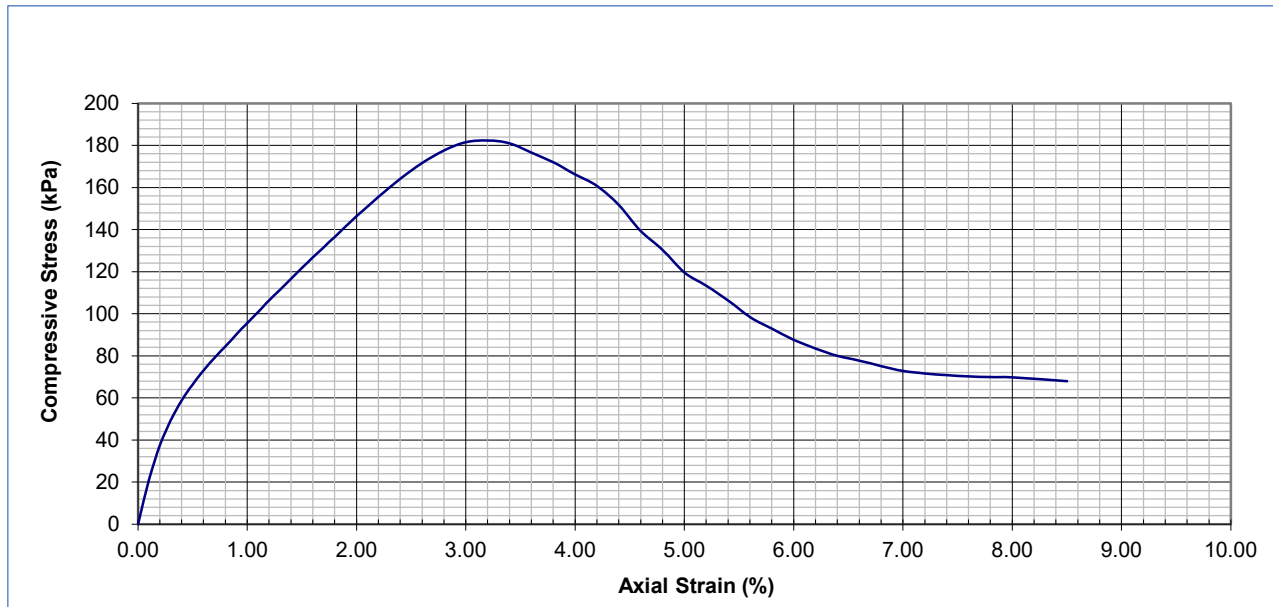

**Reported By:** R. Serluca . Lab Manager **Date:** January 22,2025  
**Reviewed By:** A. Touhidi **Date:** February 18,2025

Notice: The test data given herein pertain to the sample provide, and may not be applicable to other production zones/periods. This report constitutes a testing service only. Interpretation of the data given here may be provided upon request.

Suite 300, 4342 Queen St, Niagara Falls, Ontario, Canada, L2E 7J7 Tel:1 (905) 374 5200 www.hatch.com.

©Hatch 2017 All rights reserved, including all rights relating to the use of this document and its contents.

**Unconsolidated Undrained Triaxial Compression  
Test on Cohesive Soils  
ASTM D2850-15**



Date: January 20, 2025  
Project Number: H/375142  
Project: Fitzroy BESS

**Brookfield Renewable Power**  
181 Bay St. Suite 300, Toronto, ON M5J 2T3  
Attn: Ted Beadle

Sample	4.57 m to 5.17 m
Source	FY24-05



**BEFORE**



**AFTER**

**NOTES:**

Strain rate slightly slower than ASTM minimum recommended in order to facilitate manual readings.

# One-Dimensional Consolidation of Soils Using Incremental Loading.



Geotechnical Laboratory

ASTM D 2435-11

Date: February 10, 2025

Brookfield Renewable Power

Project Number: H/375142

Brookfield Place, Suite 100, 181 Bay St. Toronto

Project: Fitzroy BESS

Attn: Ted Beadle

<b>Sample</b>	TO1	<b>Depth</b>	15 ft to 17 ft
<b>Source</b>	FY24-05	<b>Method</b>	A - 24 hour Increments

**Soil Type:** Clayey SILT, trace Sand, trace Gravel.

Initial Height of Specimen	1.853	cm	Final Height of Sample	1.389	cm
Initial Void Ratio	1.442	-	Final Void Ratio	0.830	-
Initial Degree of Saturation	100.5	%	Final Degree of Saturation	99.9	%
Initial Wet Density	1.732	g/cm <sup>3</sup>	Final Wet Density	1.972	g/cm <sup>3</sup>
Initial Moist Specimen Mass	101.99	grams	Specific Gravity	2.78	
Initial Dry Density	1.14	g/cm <sup>3</sup>	Specimen Diameter	6.361	cm
Initial Moisture Content	52.1	%	Final Moisture Content	29.8	%

Load Stage	Pressure kPa	Final Void Ratio	Final Height cm	t <sub>50</sub> min.	c <sub>v</sub> cm <sup>2</sup> /s	m <sub>v</sub> 1/kPa	k cm/s
Initial	0.0	1.442	1.853				
1	11.5	1.434	1.847				
2	23.9	1.423	1.839				
3	47.7	1.412	1.831				
4	95.5	1.391	1.814				
5	190.9	1.274	1.726				
6	381.8	0.989	1.510	2.89	4.08E-02	6.99E-04	2.80E-06
7	763.7	0.820	1.381	1.82	2.22E-01	2.33E-04	5.08E-06
8	1527.4	0.702	1.292	1.00	6.20E-01	8.77E-05	5.33E-06
9	763.7	0.699	1.290				
10	190.9	0.719	1.304				
11	47.7	0.744	1.324				
12	11.5	0.769	1.343				

DRAFT - FINAL RESULTS PENDING

Reported By: R.Serluca, Laboratory Manager

Date: February 18, 2025

Reviewed By: T. Beadle

Date: February 24, 2025

Notice: The test data given herein pertain to the sample provide, and may not be applicable to other production zones/periods. This report constitutes a testing service only. Interpretation of the data given here may be provided upon request.

Suite 300, 4342 Queen St, Niagara Falls, Ontario, Canada, L2E 7J7 Tel:1 (905) 374 5200 www.hatch.com.

©Hatch 2017 All rights reserved, including all rights relating to the use of this document and its contents.

# One-Dimensional Consolidation of Soils Using Incremental Loading.

ASTM D 2435-11



Geotechnical Laboratory

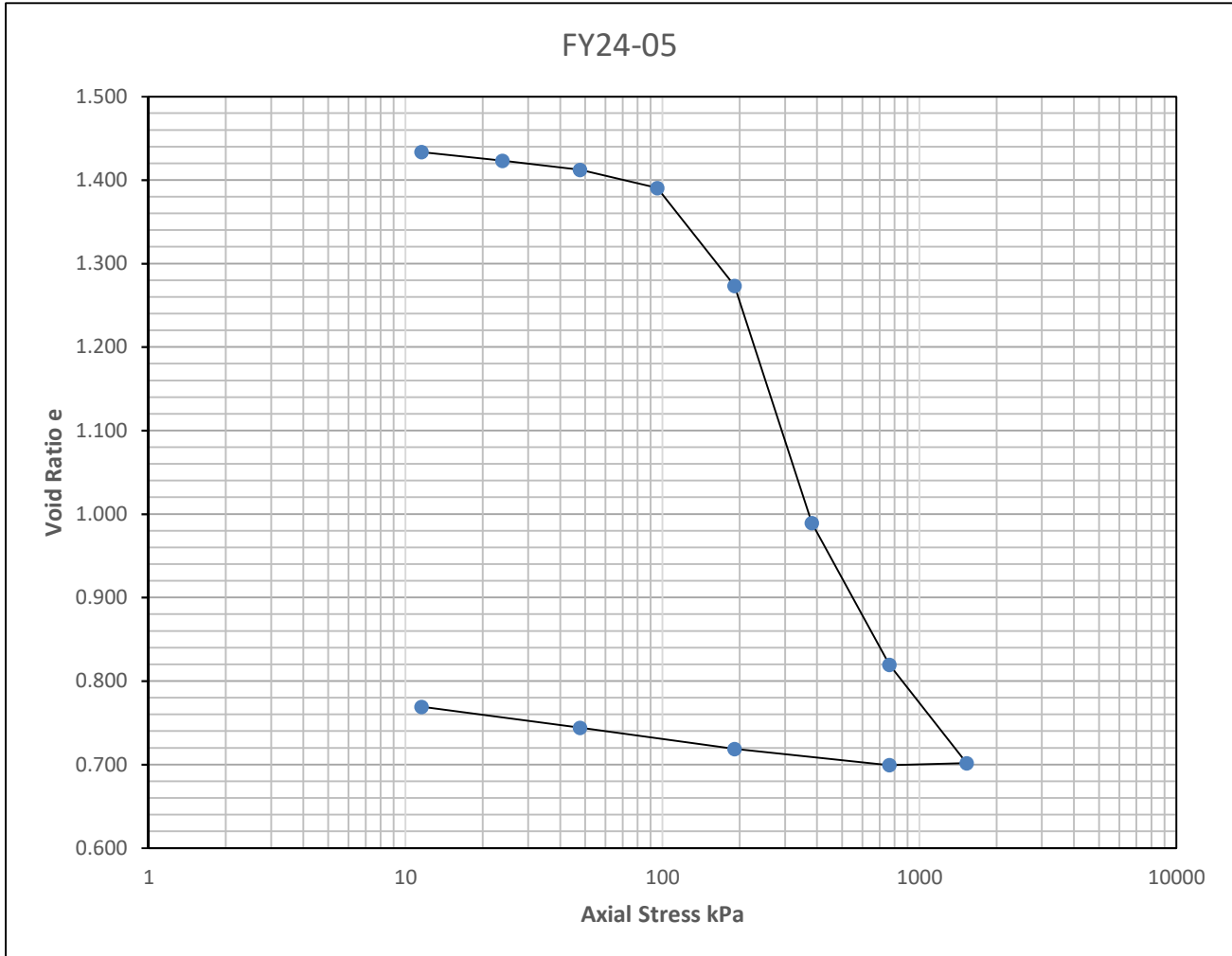

DRAFT - FINAL RESULTS PENDING

# Thermal Resistivity Report ASTM D:5334

Project: **H/375142/999-0101**

Job #: **15599**

Client: **Hatch**

Date: **1/22/25**

Boring	Specimen Type	Depth (ft)	Type	Classification	Proctor Values		Initial Conditions			Dry
					Maximum Dry Density (PCF)	Optimum Moisture (%)	Dry Density (PCF)	WC (%)	Thermal Resistivity (°C-cm/W)	Thermal Resistivity (°C-cm/W)
<b>FY24-1</b>	<b>Reconstituted</b>	<b>1-5</b>	<b>Bulk</b>	<b>Lean Clay (CL)</b>	<b>104.0</b>	<b>21.6%</b>	<b>88.6</b>	<b>28.4%</b>	<b>81</b>	<b>194</b>
Specimens reconstituted to approximately 85% of maximum standard proctor density near the greater of the as received or optimum moisture content.										

9530 James Ave South



Bloomington, MN 55431

<http://www.soilengineeringtesting.com>

# Thermal Resistivity Report ASTM D:5334

Project: H/375142/999-0101  
Client: Hatch

Job: 15599  
Date: 1/22/25

Specimen A: 

Boring	Depth (ft)
FY24-1	1-5

## Thermal Dryout Curves (Water Content vs. Resistivity)

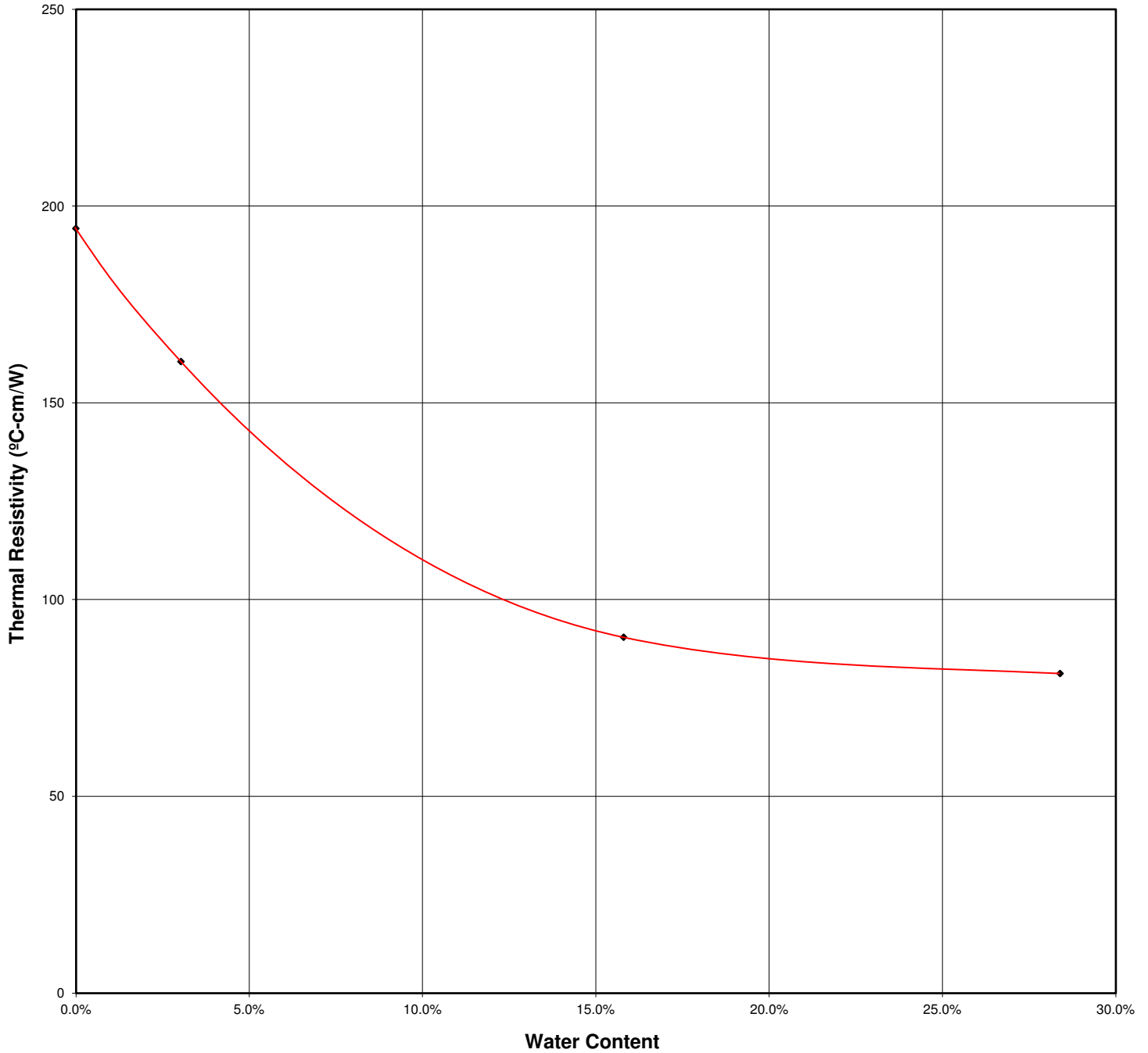

◆ A

# Moisture Density Curve ASTM: D698, Method B

Project: H/375142/999-0101

Date: 1/14/25

Client: Hatch

Job No. 15599

Boring No. FY24-1

Sample:

Depth(ft): 1-5

Location:

Soil Type: Lean Clay (CL)

As Received W.C. (%): 28.6

LL: 38

PL: 18

PI: 20

Specific Gravity: 2.71

\*Assumed

Maximum Dry Density (pcf): 104.0

Opt. Water Content (%): 21.6

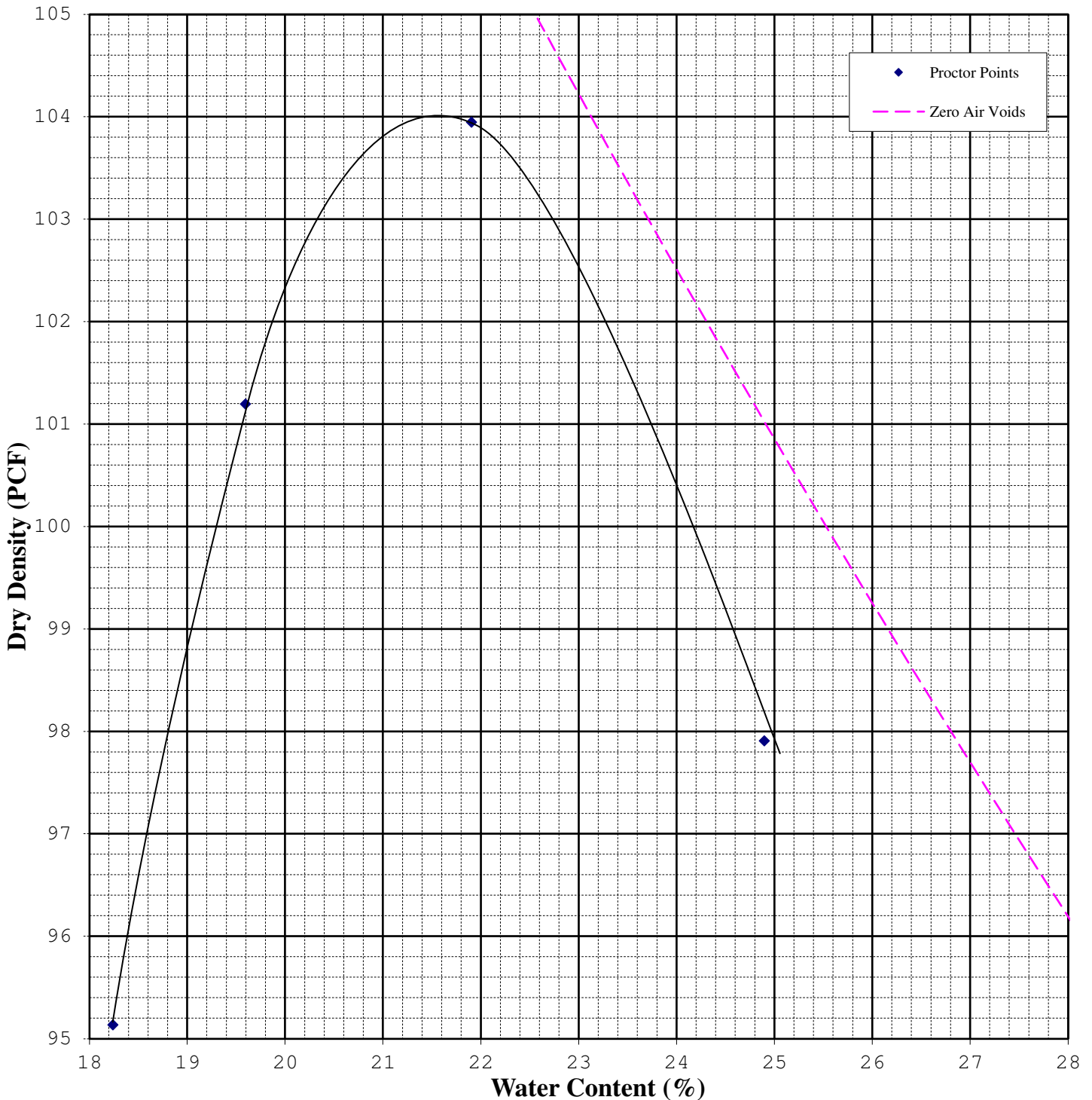

9530 James Ave South



Bloomington, MN 55431

# California Bearing Ratio ASTM:D1883

Project:		H/375142/999-0101		Job:	15599
Client:		Hatch		Date:	1/16/25
Boring #:	FY24-1			Procedural Method:	
Sample:				Specimens compacted to approximately 95% of maximum standard proctor density at optimum moisture content. Specimens soaked for a period of 4 days before CBR test was performed.	
Depth (ft):	1-5				
Type:	Bulk				
Classification:	Lean Clay (CL)				
Laboratory Moisture-Density Values			Index Properties		
Method:		ASTM:D698 Method B		LL:	Gs:
Maximum Dry Density (PCF):	104.0			PL:	Organic Content:
Optimum Water Content:	21.5%			PI:	pH:
Initial Molding Conditions					
Specimen	A				
Compaction Hammer:	5 lb				
Number of Layers:	3				
Blows per Layer:	NA				
Initial Moisture Content:	21.5%				
Initial Dry Density (PCF)	99.0				
Relative Compaction	95.2%				
Soaking Phase					
Days Soaked	4				
Surcharge (psf)	50				
Total Swell (%)	1.8%				
Penetration Phase					
Surcharge (psf)	50				
Corrected CBR Values					
at 0.1 inch (%)	3.1%				
at 0.2 inch (%)	2.8%				
Moisture Content After Penetration					
Top 1" of Specimen:	24.4%				
Average of specimen:	22.9%				

## Stress vs. Penetration Graph

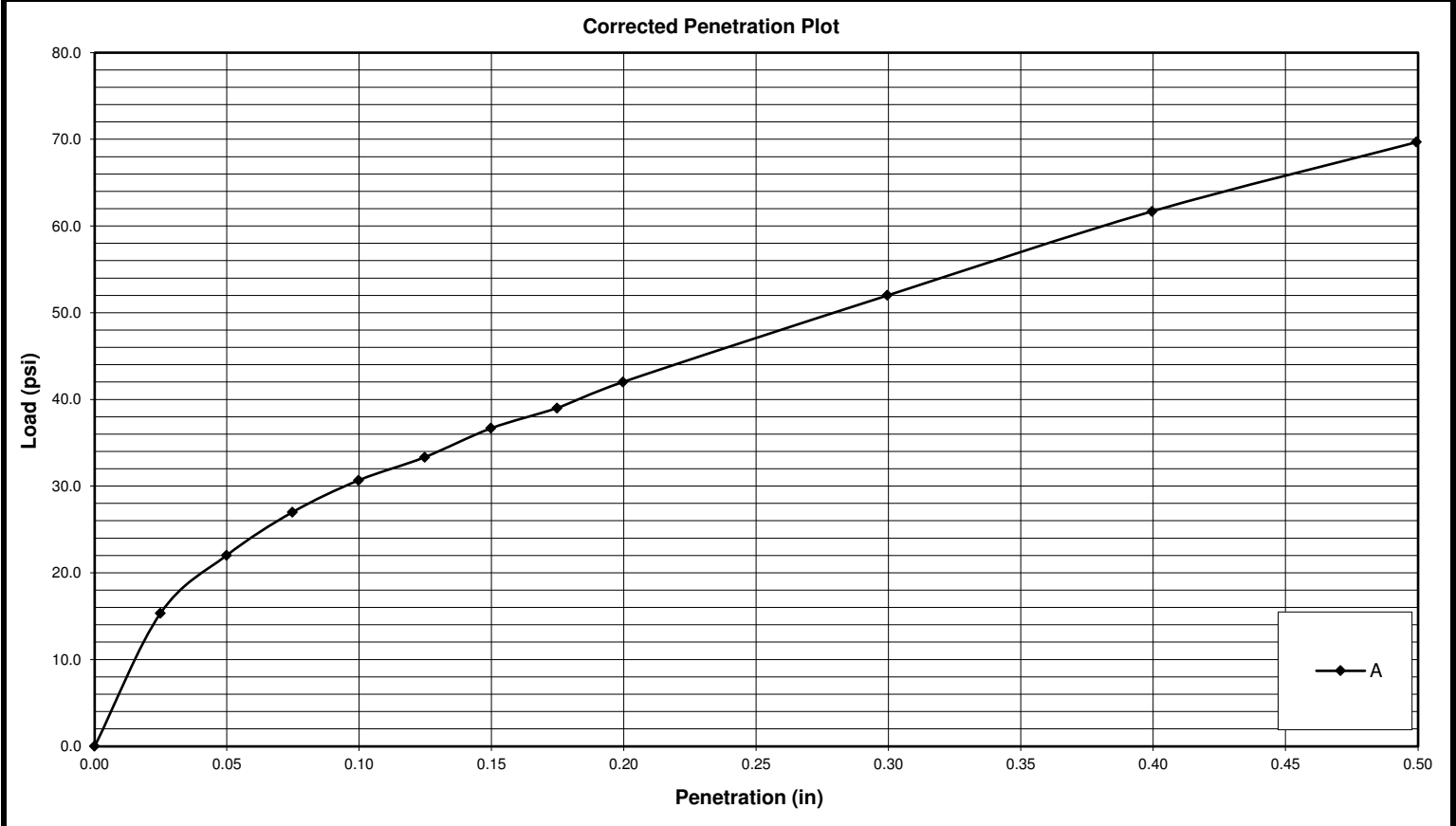

# Appendix D Chemical Testing

DRAFT

## Certificate of Analysis

**Hatch Ltd.**

4342 Queen Street, Suite 300

Niagara Falls, ON L2E 7J7

Attn: Ted Beadle

Client PO:

Project: H/375035 / H/375142

Custody: 145330

Report Date: 24-Dec-2024

Order Date: 18-Dec-2024

**Order #: 2451324**

This Certificate of Analysis contains analytical data applicable to the following samples as submitted:

Parcel ID	Client ID
2451324-01	TR24-1-C1
2451324-02	TR24-6-C1
2451324-03	FY24-1-C1
2451324-04	FY24-5-C1

Approved By:



Alex Enfield, MSc

Lab Manager

Certificate of Analysis

Report Date: 24-Dec-2024

Client: Hatch Ltd.

Order Date: 18-Dec-2024

Client PO:

Project Description: H/375035 / H/375142

**Analysis Summary Table**

Analysis	Method Reference/Description	Extraction Date	Analysis Date
Anions	EPA 300.1 - IC, water extraction	23-Dec-24	23-Dec-24
pH, soil	EPA 150.1 - pH probe @ 25 °C, CaCl buffered ext.	19-Dec-24	20-Dec-24
Resistivity	EPA 120.1 - probe, water extraction	23-Dec-24	24-Dec-24
Solids, %	CWS Tier 1 - Gravimetric	19-Dec-24	20-Dec-24

Certificate of Analysis

Report Date: 24-Dec-2024

Client: Hatch Ltd.

Order Date: 18-Dec-2024

Client PO:

Project Description: H/375035 / H/375142

<b>Client ID:</b>	TR24-1-C1	TR24-6-C1	FY24-1-C1	FY24-5-C1	-	-
<b>Sample Date:</b>	18-Dec-24 11:00	18-Dec-24 11:00	18-Dec-24 11:30	18-Dec-24 11:30	-	-
<b>Sample ID:</b>	2451324-01	2451324-02	2451324-03	2451324-04	-	-
<b>Matrix:</b>	Soil	Soil	Soil	Soil	-	-
<b>MDL/Units</b>						

**Physical Characteristics**

% Solids	0.1 % by Wt.	88.3	87.5	73.9	72.3	-	-
----------	--------------	------	------	------	------	---	---

**General Inorganics**

pH	0.05 pH Units	7.36	7.33	7.16	7.10	-	-
Resistivity	0.10 Ohm.m	65.5	102	175	106	-	-

**Anions**

Chloride	5 ug/g	<5	<5	<5	<5	-	-
Sulphate	5 ug/g	72	7	10	6	-	-

Certificate of Analysis

Report Date: 24-Dec-2024

Client: Hatch Ltd.

Order Date: 18-Dec-2024

Client PO:

Project Description: H/375035 / H/375142

**Method Quality Control: Blank**

Analyte	Result	Reporting Limit	Units	%REC	%REC Limit	RPD	RPD Limit	Notes
<b>Anions</b>								
Chloride	ND	5	ug/g					
Sulphate	ND	5	ug/g					
<b>General Inorganics</b>								
Resistivity	ND	0.10	Ohm.m					

Certificate of Analysis

Report Date: 24-Dec-2024

Client: Hatch Ltd.

Order Date: 18-Dec-2024

Client PO:

Project Description: H/375035 / H/375142

**Method Quality Control: Duplicate**

Analyte	Result	Reporting Limit	Units	Source Result	%REC	%REC Limit	RPD	RPD Limit	Notes
<b>Anions</b>									
Chloride	ND	5	ug/g	ND			NC	20	
Sulphate	63.6	5	ug/g	72.4			13.0	20	
<b>General Inorganics</b>									
pH	7.12	0.05	pH Units	7.11			0.1	10	
Resistivity	77.5	0.10	Ohm.m	75.9			2.0	20	
<b>Physical Characteristics</b>									
% Solids	80.8	0.1	% by Wt.	81.5			0.9	25	

Certificate of Analysis

Report Date: 24-Dec-2024

Client: Hatch Ltd.

Order Date: 18-Dec-2024

Client PO:

Project Description: H/375035 / H/375142

**Method Quality Control: Spike**

Analyte	Result	Reporting Limit	Units	Source Result	%REC	%REC Limit	RPD	RPD Limit	Notes
<b>Anions</b>									
Chloride	10.8	5	ug/g	ND	105	80-120			
Sulphate	16.9	5	ug/g	7.24	97.0	80-120			

Certificate of Analysis

Report Date: 24-Dec-2024

Client: Hatch Ltd.

Order Date: 18-Dec-2024

Client PO:

Project Description: H/375035 / H/375142

**Qualifier Notes:**

**Sample Data Revisions:**

None

**Work Order Revisions / Comments:**

None

**Other Report Notes:**

n/a: not applicable

ND: Not Detected

MDL: Method Detection Limit

Source Result: Data used as source for matrix and duplicate samples

%REC: Percent recovery.

RPD: Relative percent difference.

NC: Not Calculated

Soil results are reported on a dry weight basis unless otherwise noted.

Where %Solids is reported, moisture loss includes the loss of volatile hydrocarbons.

Any use of these results implies your agreement that our total liability in connection with this work, however arising, shall be limited to the amount paid by you for this work, and that our employees or agents shall not under any circumstances be liable to you in connection with this work.

Parcel ID: 2451324



Parcel Order Number  
(Lab Use Only)

Chain of Custody  
(Lab Use Only)

No 145330

Client Name: <b>Hatch</b>	Project Ref: <b>H/375035 / H/375142</b>	Page <b>1</b> of <b>1</b>
Contact Name: <b>Ted Beadle</b>	Quote #:	<b>Turnaround Time</b> <input type="checkbox"/> 1 day <input type="checkbox"/> 3 day <input type="checkbox"/> 2 day <input checked="" type="checkbox"/> Regular
Address: <b>4342 Queen St. Niagara Falls, ON</b>	PO #:	
Telephone: <b>647-523-5446</b>	E-mail: <b>ted.beadle@hatch.com</b>	
Date Required: _____		

<input type="checkbox"/> REG 153/04 <input type="checkbox"/> REG 406/19 <b>Other Regulation</b> <input type="checkbox"/> Table 1 <input type="checkbox"/> Res/Park <input type="checkbox"/> Med/Fine <input type="checkbox"/> REG 558 <input type="checkbox"/> PW00 <input type="checkbox"/> Table 2 <input type="checkbox"/> Ind/Comm <input type="checkbox"/> Coarse <input type="checkbox"/> CCME <input type="checkbox"/> MISA <input type="checkbox"/> Table 3 <input type="checkbox"/> Agri/Other <input type="checkbox"/> SU - Sani <input type="checkbox"/> SU-Storm <input type="checkbox"/> Table _____ <input type="checkbox"/> Other For RSC: <input type="checkbox"/> Yes <input type="checkbox"/> No <input type="checkbox"/> Other		<b>Matrix Type:</b> S (Soil/Sed.) GW (Ground Water) SW (Surface Water) SS (Storm/Sanitary Sewer) P (paint A (Air) O (Other))	<b>Required Analysis</b>										
Sample ID/Location Name	Matrix	Air Volume	# of Containers	Sample Taken		PHCs F1-F4+BTEX	VOCs	PAHs	Metals by ICP	Hg	CrVI	B (HWS)	Corrosivity Package
				Date	Time								
1 TR24-1-C1	Soil		1	Dec.18/24	11:00								X
2 TR24-6-C1	Soil		1	Dec.18/24	11:00								X
3 FY24-1-C1	Soil		1	Dec.18/24	11:30								X
4 FY24-5-C1	Soil		1	Dec.18/24	11:30								X
5													
6													
7													
8													
9													
10													

Comments:		Method of Delivery: <b>WALK IN</b>	
Relinquished By (Sign):	Received at Depot: <b>B. Bator (Niagara)</b>	Received at Lab: <b>Km</b>	Verified By: <b>Km</b>
Relinquished By (Print):	Date/Time: <b>Dec 18/24 @ 4:50 pm</b>	Date/Time: <b>12/19/24 1030</b>	Date/Time: <b>12/19/24 1035</b>
Date/Time:	Temperature: <b>2°</b> °C	Temperature: <b>6.9</b> °C	pH Verified: <input type="checkbox"/> By: <b>NA</b>

# Appendix E

## Electrical Resistivity Testing

DRAFT

Project Report

February 14, 2025

**Brookfield Renewable**

**Electrical Resistivity Field Testing**  
**Table of Contents**

1. Introduction..... 2

2. Methodology ..... 2

3. Field Work ..... 3

4. Limitations of Use..... 6

5. Closure ..... 7

## 1. Introduction

This report presents the results of the Vertical Electric Sounding survey carried out by Hatch on November 27, 2024, at the South March Battery Energy Storage System (BESS) site in Dunrobin, Ontario. The objective of the survey was to conduct soil resistivity tests using the 4-electrode Wenner method at the site.

## 2. Methodology

The Wenner 4-electrode method is also known as a vertical electric resistivity sounding (VES). This method is described by ASTM G57-06 and ANSI/IEEE Standard 81-1983 standards. To determine the soils resistivity, four evenly spaced steel electrodes are inserted into the soil in a straight line and a DC or AC test current is applied to the outer two electrodes. The associated potential difference  $V$  is measured between the inner pair of potential electrodes. The effective resistance  $R$  of subsurface material is measured and converted to units of Ohms using Ohms' law,  $R=V/I$ . The influence of each specific electrode spacing between electrodes is then converted to the soils apparent resistivity using the geometrical correction factor  $\rho_a \cdot m = 2\pi a R$  where ( $a$ ) is the electrode spacing in meters. The apparent resistivity is then reported in units of ohm-metres ( $\Omega \cdot m$ ).

The test is carried out by keeping the test instrument at central location, while the  $a$ -spacing between the current electrodes (C1 and C2) and potential electrodes (P1 and P2) is increased outwards from the central location in steps in order to achieve greater depth penetration (see Figure 1 below). The survey depth increases with increasing electrode separation to yield a vertical electrical sounding of the subsurface. This approach highlights changes in vertical stratification in electrical properties of the ground. Where possible, the test array is then rotated 90 degrees creating two orthogonal spreads about a common midpoint to investigate the possibility of planar anisotropy in the ground where space permits.

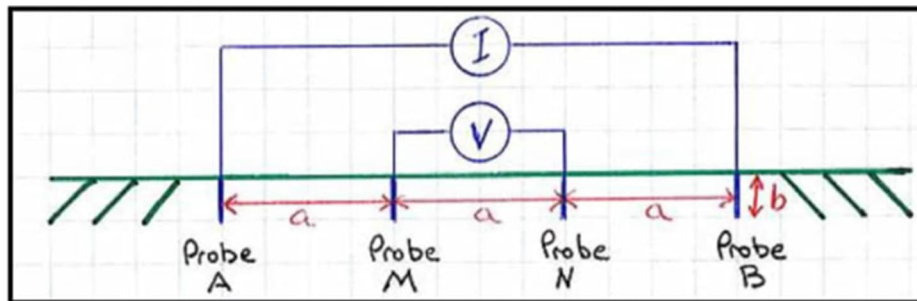

**Figure 1: Typical Wenner Array Configuration**

The data were acquired with the following standards as guidelines.

- ASTM Standard G 57, 2006, "Standard Test Method for Field Measurement of Soil Resistivity Using the Wenner Four-Electrode Method," ASTM International, West Conshohocken, PA.

- ANSI/IEEE Standard 81, 1983, "Guide for Measuring Earth Resistivity, Ground Impedance, and Earth Surface Potentials of a Ground System," The Institute of Electrical and Electronics Engineers, Inc., New York, NY, USA.

### 3. Field Work

Two intersecting VES lines were collected. The VES data were acquired using a Syscal R1 Plus soil resistivity meter using the 4-electrode Wenner survey. Electrode 'a'-spacings of 0.61, 1.5, 3.0, 6.1, 15.2, 30.5, and 61.0 m were employed for Line A, and 0.61, 1.5, 3.0, 6.1, 15.2, 30.5, and 36.6 m for Line B.

Cold, windy and sunny conditions persisted throughout the duration of the field testing. Temperature ranged from -1 and 5 degrees Celsius.

The ground surface at the South March BESS site is grass covered, and soil conditions were moist at the time of testing due to light rain in the previous day. Terrain is generally flat.

Figure 2 displays a general project location map indicating the VES test location.



Figure 2: Site Map Showing VES Test Location (Red Line)

Table 1 shows the NAD 83 MTM Zone 9 coordinates for each VES line. Table 2 and 3 shows the measurements taken on site and Figures 3 and 4 presents the graphical results of the VES data.

**Table 1: Coordinates of VES Lines**

Line	Location of Point	Easting (m)	Northing (m)	Approximate Elevation (masl)
A	West End	340,557.11	5,028,466.98	100.89
	Mid-Point	340,622.44	5,028,532.00	100.89
	East End	340,686.68	5,028,598.05	100.43
B	North End	340,548.64	5,028,545.91	100.89
	Mid-point	340,596.32	5,028,511.54	100.89
	South End	340,635.99	5,028,479.48	102.89

**Table 2: Measured Data of VES Line A**

Electrode Spacing (a) m	Pin Depth (d) m	Voltage (mV)	Current (mA)	Resistance $\Omega$	Apparent Resistivity ( $\Omega$ -m)
0.61	0.06	3,273.55	161.36	20.29	77.67
1.5	0.15	805.59	245.42	3.28	31.42
3.0	0.15	709.60	334.07	2.12	40.66
6.1	0.15	685.09	370.32	1.85	70.82
15.2	0.15	831.43	440.58	1.89	180.61
30.5	0.2	988.93	495.64	2.00	381.92
61.0	0.2	1,006.02	480.76	2.09	801.09

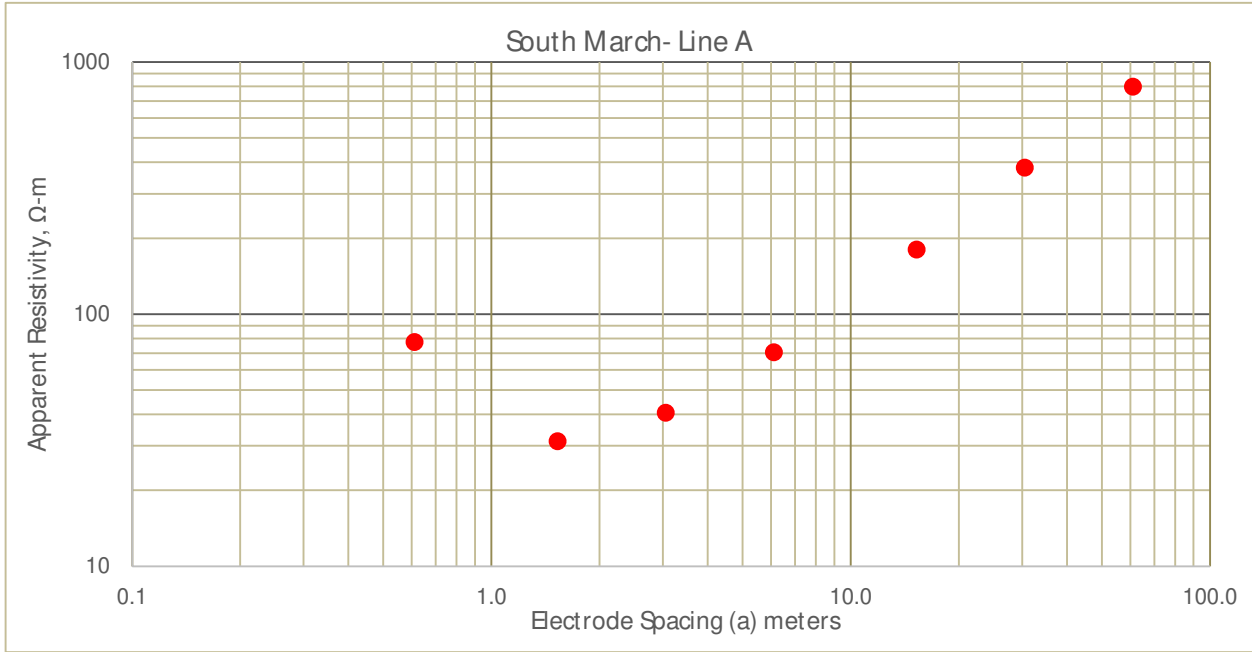

**Figure 3: Graphical Presentation of Measured VES Data Line A**

**Table 3: Measured Data of VES Line B**

Electrode Spacing (a) m	Pin Depth (d) m	Voltage (mV)	Current (mA)	Resistance $\Omega$	Apparent Resistivity ( $\Omega$ -m)
0.61	0.06	3,305.08	157.93	20.93	80.12
1.5	0.15	890.95	233.74	3.81	36.48
3.0	0.15	565.65	267.68	2.11	40.45
6.1	0.15	587.37	327.27	1.79	68.71
15.2	0.15	901.00	465.61	1.94	185.20
30.5	0.2	405.25	153.18	2.65	506.40
36.6	0.2	518.69	186.63	2.78	638.38

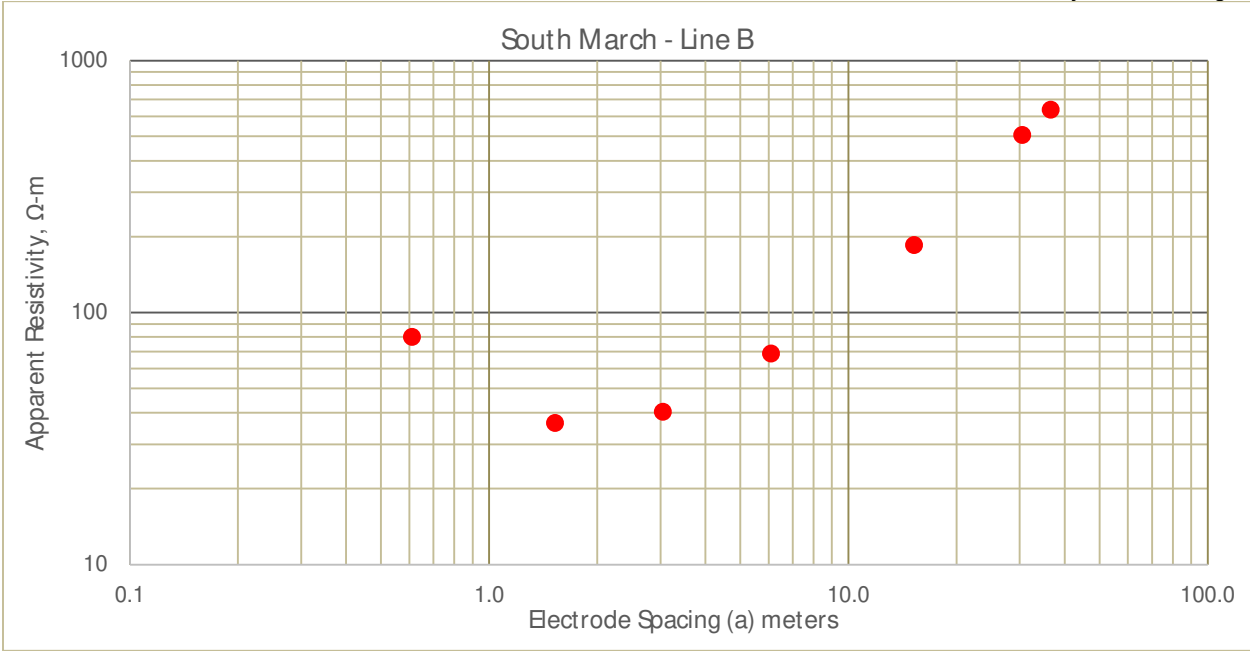

Figure 4: Graphical Presentation of Measured VES Data Line B

4. Limitations of Use

The geophysical method presented in this report is based on the use of geophysical surveying techniques. As with any geophysical method, values presented in this report should be confirmed by intrusive methods (boreholes, test pits, etc.).

This geophysical survey was carried out in a manner consistent with the level of care and skill normally exercised by other members of the engineering and science professions currently practising under similar conditions, subject to the time limits and financial and physical constraints applicable to the services provided. This is a factual report therefore no warranty is either expressed, implied, or made as to the conclusions, advice, and recommendations offered.

Any use of the information within this report made by a third party, or any reliance on, or decisions to be made based on it, are the sole responsibility of such third parties. Hatch accepts no responsibility for damages, if any, suffered by any third party as a result of decisions made or actions taken based on this report.

## 5. Closure

We trust that this technical memorandum meets your needs at the present time. If you have any questions or require clarification, please contact the undersigned at your convenience.

Ralph Serluca C. Tech  
*Civil Technologist*

# Appendix F

## Rock Core Photographs

DRAFT



FY24-1- Box 1 - 6.14 m - 9.14 m