



Lansdowne 2.0

PHASE 1
945 BANK ST. – EVENT CENTRE
URBAN DESIGN BRIEF

SUBMISSION #1 REV. 1 // JUNE 27, 2024

BRISBIN
BROOK
BEYNON

ARCHITECTS

FOTENN

CSW

Table of Contents

1. INTRODUCTION	3	4. SITE CONTEXT	12	5. DESIGN RESEARCH	23
2. PROJECT DESCRIPTION	4	Existing Site Conditions.....	12-13	Parti Diagram	23
Project Objective & Overview	4	Protected Views Corridors.....	14	Architectural Precedents.....	24
Project Design Intent	5	Built and Natural Heritage Assets.....	15	Landscape Precedents.....	24
Project Statistics	5	Microclimate Analysis	16	Design Evolution.....	24
Project Renderings.....	6-9	Key Uses and Spatial Elements	17	Public Realm Landscape & Circulation.....	25-27
3. DESIGN DIRECTIVE	10	Urban Pattern.....	18	Massing (Existing Context).....	28
Planning Framework Policy Context	10	Characteristics and Public Realm.....	19	Massing (Planned Context).....	29
Planning Framework City of Ottawa Zoning By-Law	11	Mobility Networks	20	Block Plan (Future Developments)	30
		Future and Current Adjacent Developments	21	Sustainable Design.....	31-32
		Surrounding Development & Planned Function	22	Bird Safe Design.....	33

Appendices

- A) Site Plans Phased & Detailed
- B) Floorplans & Elevations
- C) Landscape Plan
- D) Grading and Drainage Plan
- E) Site Servicing Plan
- F) Shadow Analysis
- G) Wind Analysis
- H) Heritage Impact Statement

Project Team

Architect — Brisbin Brook Beynon Architects

Planner — Fotenn

Landscape Architect — CSW

Heritage Consultant — ERA

Site Services — WSP



1. INTRODUCTION

We are pleased to submit this Urban Design Report for the Lansdowne 2.0 — Phase 1 Event Centre project, in accordance with Ottawa's Urban Design Brief Terms of Reference. This submission has been prepared to demonstrate the context behind the development and the site, current design direction of the Event Centre, and alignment with the City's design policies and Official Plan.

This Urban Design Brief substantiate our current design approach and preliminary considerations, providing background information and visuals of the proposed development. This report aims to assist in the review process, ensuring that the design seamlessly integrates with its urban context and enhances the existing environment.

We believe that the materials provided illustrate our commitment to creating a vibrant, multi-use, and community-focused Event Centre that will serve as a significant asset to the Lansdowne and Ottawa.

Thank you for your consideration of our submission. We look forward to your feedback and are available to discuss any aspects of the report in further detail.



2. PROJECT DESCRIPTION

PROJECT OBJECTIVE

The new Event Centre project for Lansdowne 2.0 aims to honour and celebrate Lansdowne's rich history as a cornerstone of Ottawa's civic, cultural, and sports district while offering a generational opportunity to renew and invigorate this landmark destination. Leveraging Lansdowne's unique location and its potential to be a year-round gathering place for Ottawa, the project introduces a new world-class event centre and improved public infrastructure. These enhancements will bolster accessibility, placemaking, and economic activity, reinforcing Lansdowne as a thriving and vibrant destination and community asset.

PROJECT OVERVIEW

Located in the heart of Lansdowne Park and Ottawa, the new Event Centre will be a modern venue designed to host a variety of events, including concerts, sports, and other performances and activities. Situated between the Great Lawn, Aberdeen Pavilion, and TD Place Stadium, the Event Centre carefully integrates with overall site context, while adding vibrancy and a dedicated place to gather. It will offer a state-of-the-art entertainment experience with seating for 5,500 patrons and a range of guest amenities. The venue will feature private suites, clubs, a viewing balcony overlooking TD Place field, and a 360-degree concourse equipped with food, beverage, and washroom facilities.

PROJECT DESIGN INTENT

The design of a new Event Centre at Lansdowne, adjacent to the Great Lawn and Aberdeen Pavilion, focuses on cohesive integration and community enhancement. The design is a harmonious blend of contemporary architecture with earth-toned aesthetics. The extensive use of glazing creates transparency and openness, while natural materials bring warmth and texture. The colour palette complements the architectural design, emphasizing and agreeing with the surrounding area. The overall ambiance is one of invitation, warmth, stability, and a strong connection to Lansdowne Park.

The project design prioritizes several elements to achieve this outcome:

- The Event Centre blends into the grass berm and the adjacent Great Lawn, promoting continuity between the overall site and the new venue. This is further reinforced by the use of natural materials, with stone-like and wood accents.
- The design intent for the Landscape space is to provide a vibrant public realm which can accommodate large public gatherings and facilitate community events while also providing an attractive landscape setting to be used for passive recreation by members of the surrounding community and visitors to Lansdowne during non-event periods.
- The Event Centre features exterior patios and a public washroom, enhancing the flexibility and usability of the space and fostering a vibrant public realm.
- The design emphasizes accessibility, ensuring that people of all abilities can comfortably enjoy all areas, both inside and outside.
- Improvements to pedestrian and active transportation access ensure safer and more efficient movement throughout the Great Lawn, the Aberdeen Pavilion, and the event centre.
- The design promotes active transportation by enhancing cycling and pedestrian connections across the site, reinforcing Lansdowne as a catalyst for sustainable urban mobility. These connections additionally tie into the Event Centre's main entrance, which features a new pedestrian route and a one-way shuttle loop for vehicles, facilitating ease of access.
- Sightlines remain undisturbed per Ontario Heritage Trust's recognized view corridors guidelines.

PRELIMINARY PROJECT STATISTICS

Lansdowne 2.0 Event Centre — Preliminary Total Gross Building Floor Area

	AREA (SF)	AREA (SM)
BACK-OF-HOUSE		
LEVEL 01 – EVENT	58,700	5,453
LEVEL 02 – CONCOURSE	5,800	538
LEVEL 03 – SUITES	5,200	483
TOTAL	69,700	6,474
EVENT SURFACE		
LEVEL 01 – EVENT	16,700	1,551
TOTAL	16,700	1,551
FRONT-OF-HOUSE		
LEVEL 01 – EVENT	3,000	279
LEVEL 02 – CONCOURSE	21,500	1,997
LEVEL 03 – SUITES	21,200	1,969
TOTAL	45,700	4,245
SEATING BOWL		
LEVEL 02 – CONCOURSE	27,800	2,583
LEVEL 03 – SUITES	4,800	446
TOTAL	32,600 f	3,029
TOTAL GROSS FLOOR AREA	164,700	15,299

Lansdowne 2.0 Event Centre — Building Height

	HEIGHT
OVERALL BUILDING HEIGHT (EVENT LEVEL TO ROOF)	63' (19,202 mm)
HEIGHT FROM GRADE (LEVEL 2 CONCOURSE TO ROOF)	44' (13,411 mm)



PRELIMINARY EXTERIOR CONCEPT RENDERING — VIEW OF NORTH EAST

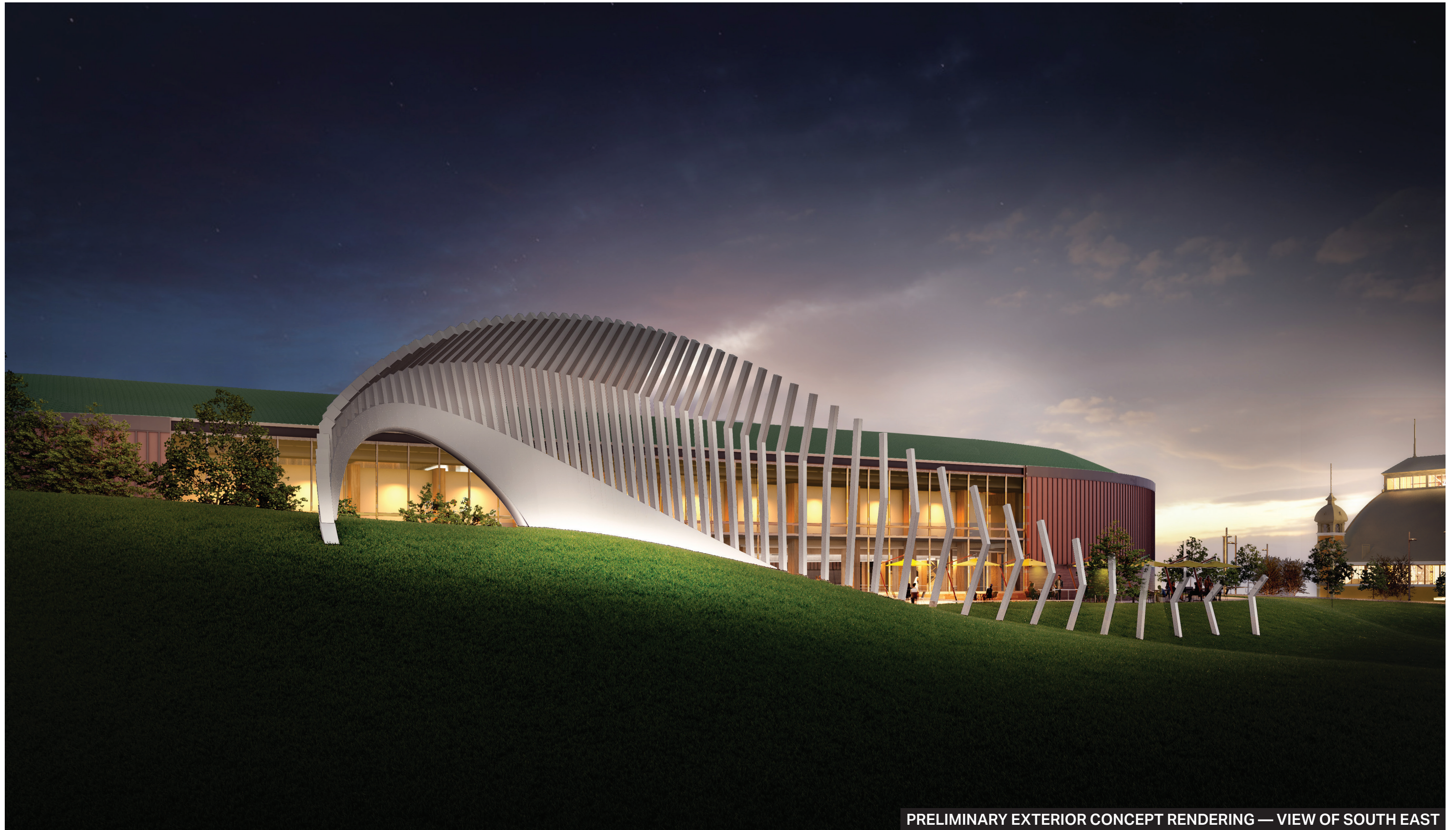

PRELIMINARY EXTERIOR CONCEPT RENDERING — VIEW OF SOUTH EAST



PRELIMINARY EXTERIOR CONCEPT RENDERING — VIEW OF WEST



PRELIMINARY AERIAL CONCEPT RENDERING — VIEW OF SITE

3. DESIGN DIRECTIVE

PLANNING FRAMEWORK POLICY CONTEXT

The subject property is located within the Inner Urban Transect of the City of Ottawa and is designated as the Lansdowne Special District in the City's Official Plan. Special Districts are parts of the City that are important internationally, nationally and to the metropolitan area. They define the image of the City through their cultural heritage value, architecture, public realm, their roles as tourism attractions and/or as major economic generators. Lansdowne is considered to be a City-defining special district, as it is a demonstration of the successful integration of a large professional sports facility within an established neighbourhood. The Special District policies provide general direction for maximum permitted building heights and more specific policies for the Lansdowne Park area, which considers heritage, transportation, the type of development, and where development is located. The proposed development conforms to the policies of the Official Plan as it relates to the Lansdowne Special District and the Inner Urban Transect. The proposed development will contribute to supporting the role of Lansdowne as a destination for amateur and professional sports, festival, concerts, etc. by creating modern, safe and efficiently maintained facilities. The proposed development will also support existing and potential new cultural assets.

The proposed development responds well to the City's policy direction as it relates to urban design. The subject site is located within a Tier 2 Design Priority Area, which is an area of national and regional importance to defining Ottawa's image. The proposed development recognizes the importance of cultural heritage assets on and around the site, and has been designed to enhance existing views of the Aberdeen Pavilion as outlined in the Heritage Easement with the Ontario Heritage Trust. The proposed development has considered four-season comfort, and how pedestrians will interact with the new spaces. Pedestrian-scale and the public realm are important elements of the proposed development that have been considered in the development of the event centre entrance.

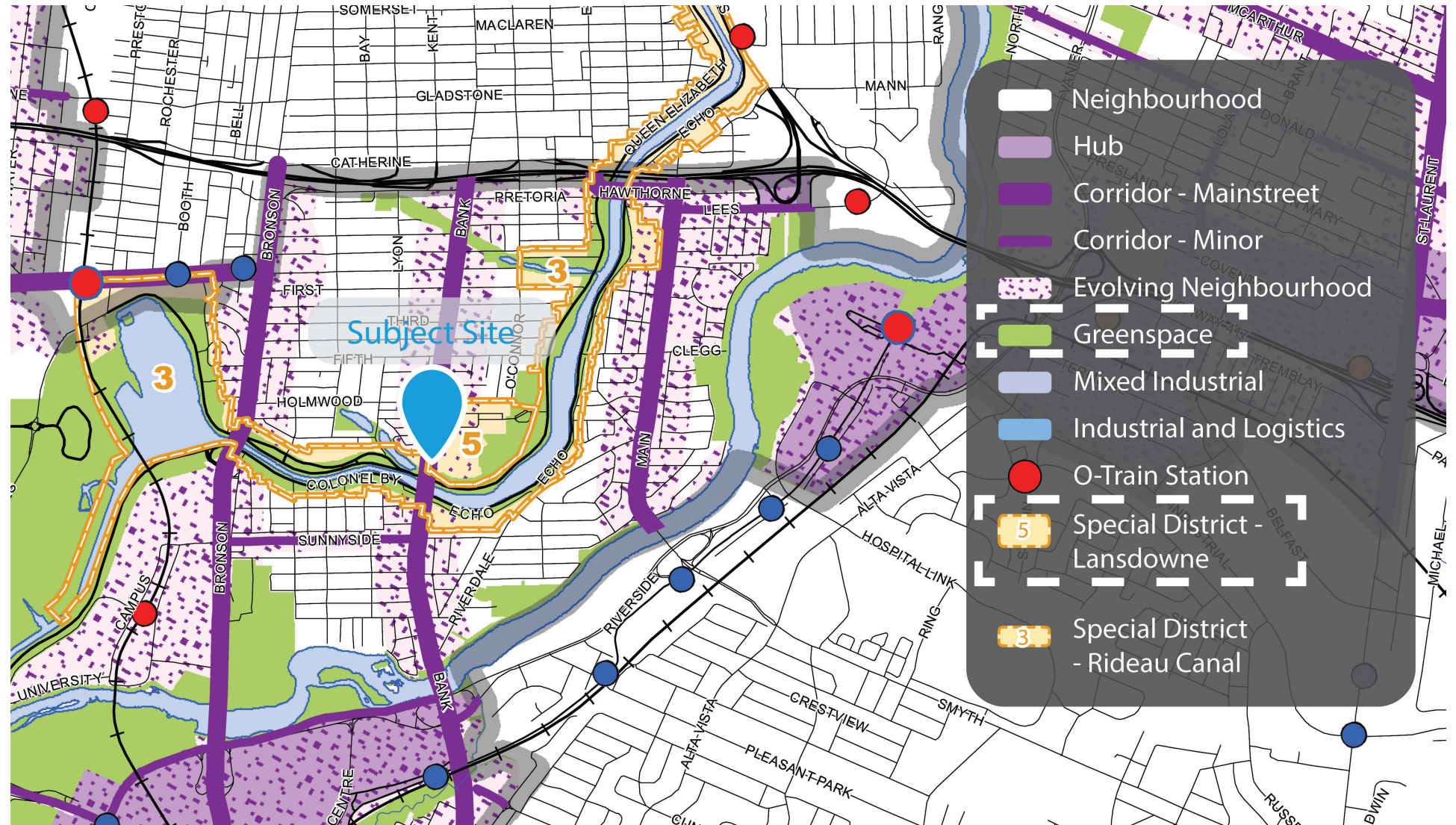

Schedule B2 – Inner Urban Transect of the Official Plan

PLANNING FRAMEWORK CITY OF OTTAWA ZONING BY-LAW

The portion of the property subject to Site Plan Control is zoned Major Leisure Facility, Subzone C, Exception 2915, Holding Zone, with site specific schedule 258-A, 258-B, and 487 (L2C[2915]-h S258-A, S258-B, S487).

The purpose of the L2C zone is to:

- Accommodate major, urban City-wide sports, recreational and cultural facilities addressed under the Major Urban Facilities policies of the Official Plan;
- Permit a broad range and intensity of leisure, recreational, cultural and related uses; and
- Allow a moderate density and scale of development.

As outlined in the previous UDRP submission for the Zoning By-law Amendment, the proposed development is consistent with the intent of the Zoning By-law, contributing to Lansdowne Park as a destination at a local, regional, and national scale. The proposed development complies with the Zoning By-law.

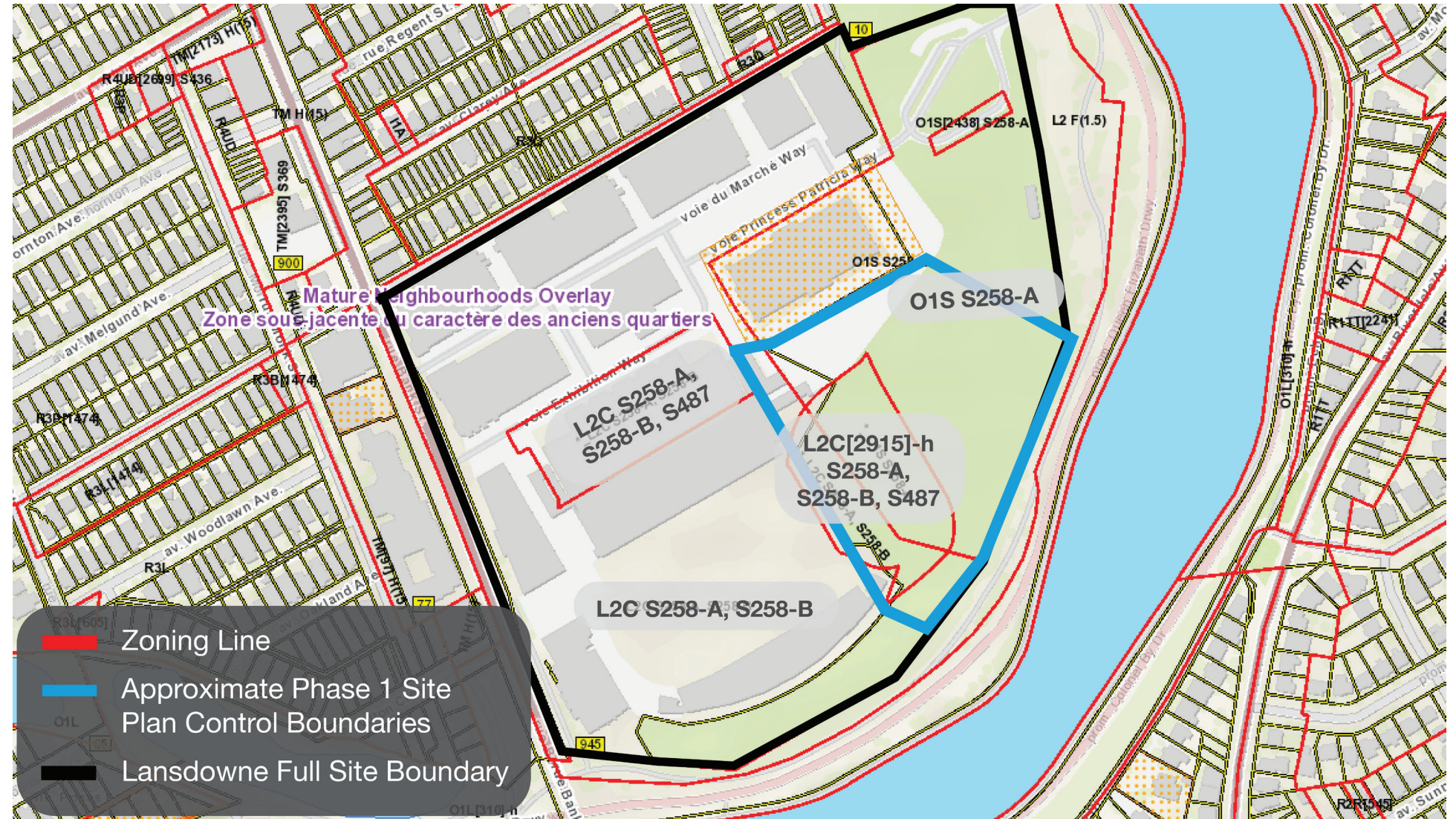

Zoning Map

4. SITE, CONTEXT & ANALYSIS

PHOTOS OF EXISTING SITE CONDITIONS

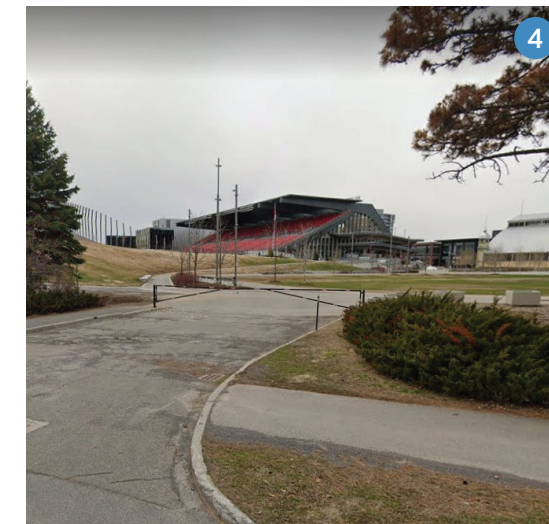
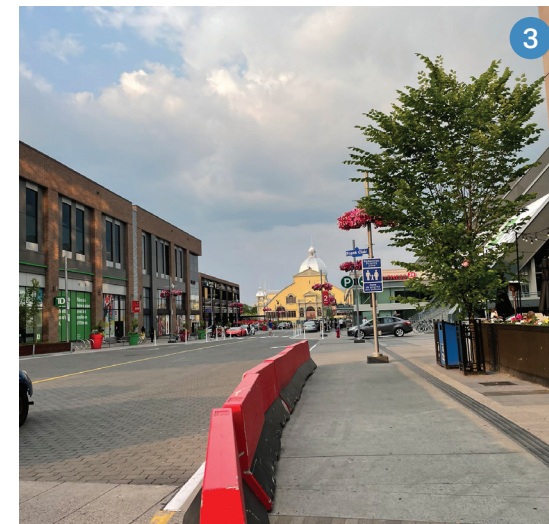
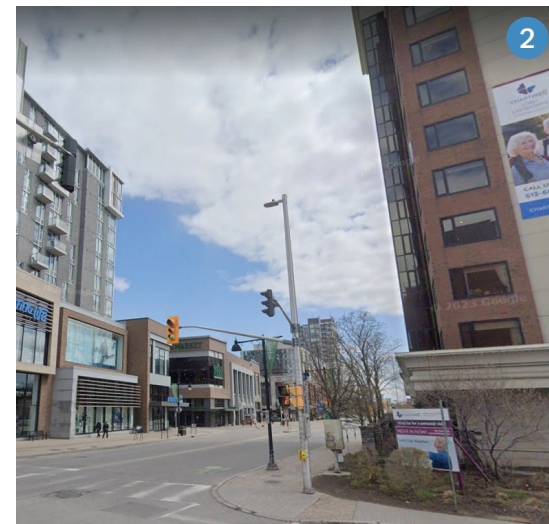
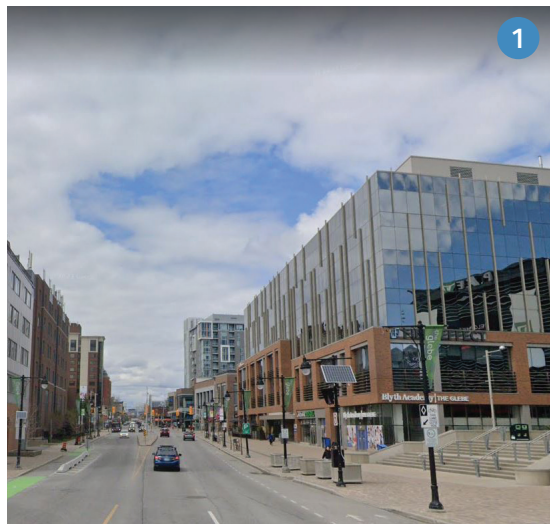
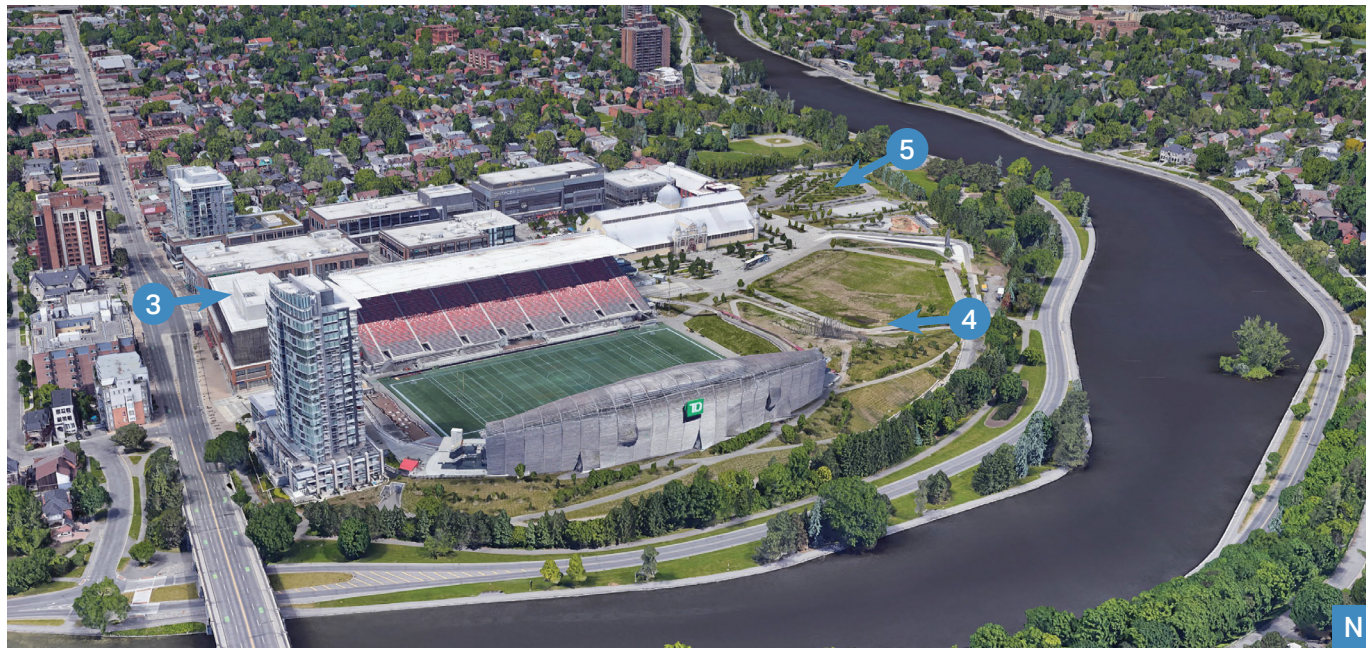

PHOTOS OF EXISTING SITE CONDITIONS

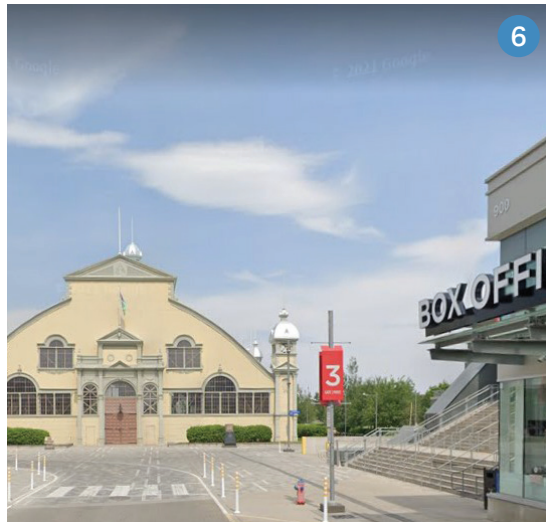

PROTECTED VIEW CORRIDORS

The HCEA identifies specific views (A-G), the Setting Lands, and the Framing Lands within Lansdowne Park as being of cultural heritage value. The placement of the proposed Event Centre in the southwest quadrant of Lansdowne Park ensures that there is no visual interference with Viewpoints E-G, which are located in the Setting Lands to the north, northwest and west of the Aberdeen Pavilion. Consequently, no further assessment is required for the impact on these three views.

The positioning of Viewpoints A-D, however, necessitates further assessment of impact. These views, which direct sight lines toward the Aberdeen Pavilion from the south, southeast and northeast, have the potential to capture the proposed Event Centre, and are analyzed in detail in the appended draft Heritage Impact Assessment.

As indicated by the view impact assessment, the Event Centre has been strategically positioned and designed to protect the views towards the Aberdeen Pavilion, particularly from the south. As a result, only minor visual impact is anticipated, particularly from Viewpoints A and D as the Event Centre will encroach somewhat into the field of view. In Viewpoint A, while the foreground is protected and unobstructed the introduction of the Event Centre to the west will alter this perspective.

In Viewpoint D, the Event Centre will be somewhat visible beyond the Aberdeen Pavilion, though its visibility will be somewhat obscured by foliage.

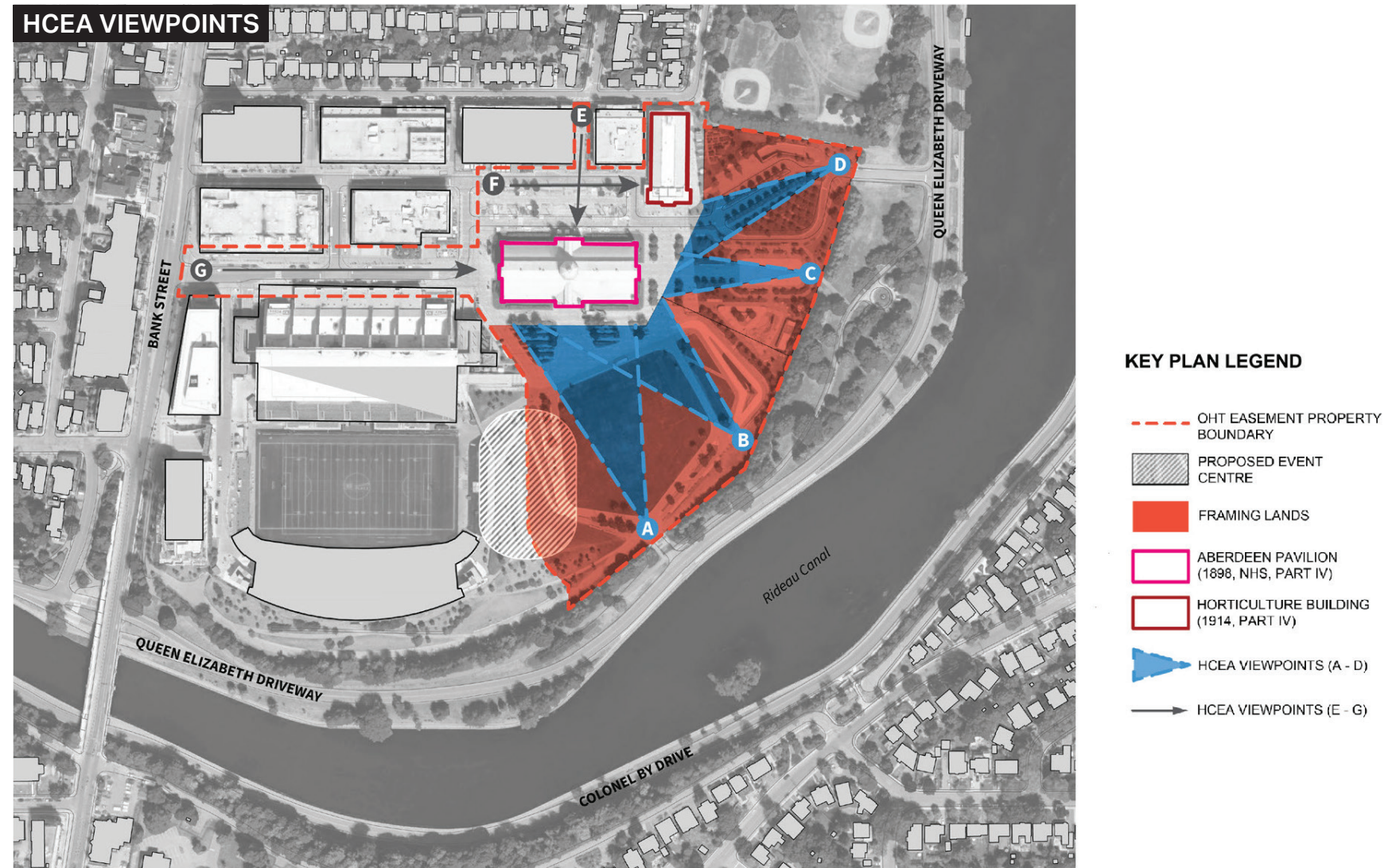

Aerial map depicting the HCEA Viewpoints (ERA, 2024).



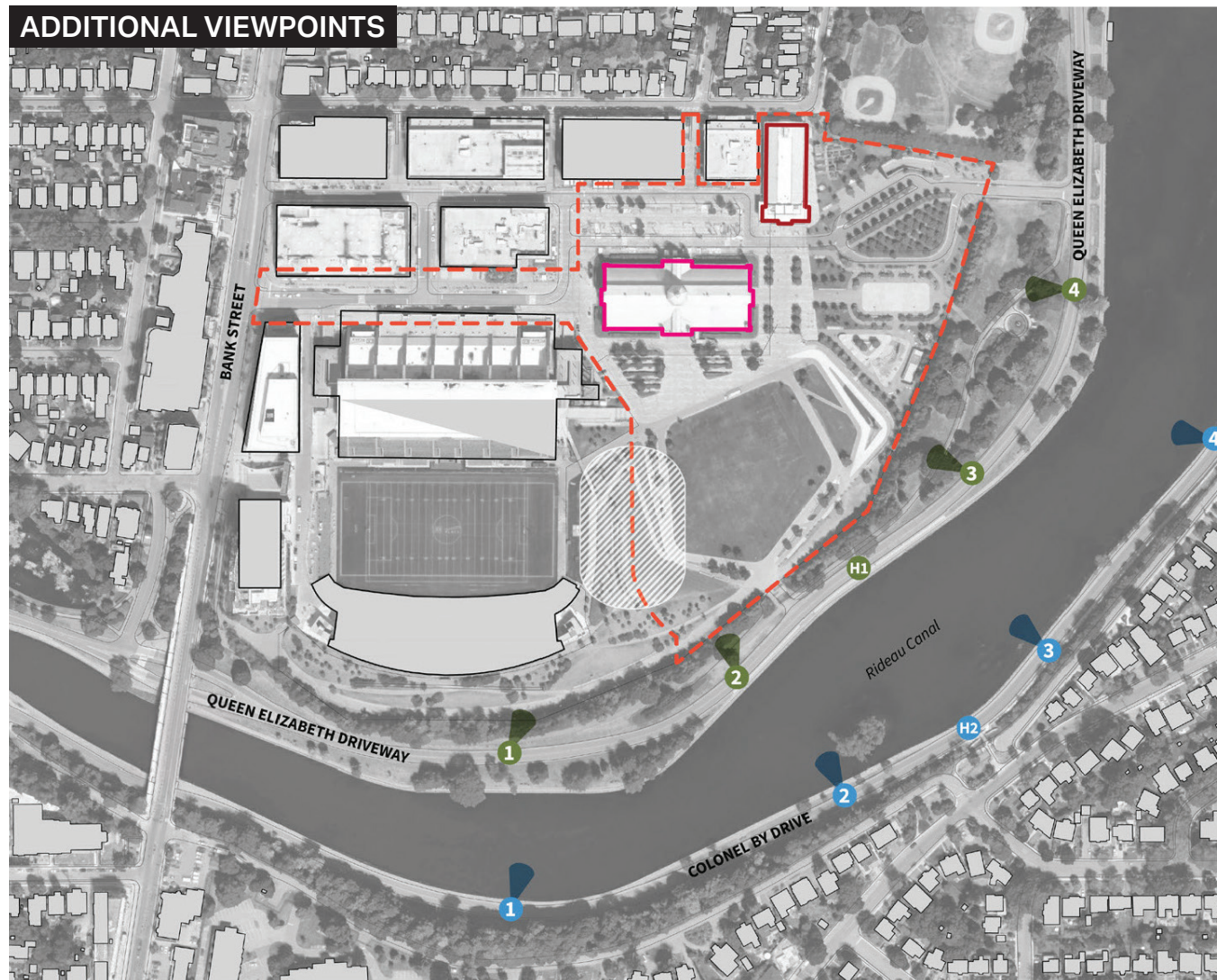

- KEY PLAN LEGEND**
- - - OHT EASEMENT PROPERTY BOUNDARY
 - PROPOSED EVENT CENTRE
 - ABERDEEN PAVILION (1898, NHS, PART IV)
 - HORTICULTURE BUILDING (1914, PART IV)
 - ▲ RIDEAU CANAL VIEWS INTO SITE FROM QED
 - ▲ RIDEAU CANAL VIEWS INTO SITE FROM COLONEL BY DRIVE

Aerial map depicting the additional considered views (ERA, 2024).

BUILT & NATURAL HERITAGE ASSETS

The proposed Event Centre does not present an impact on the Horticulture Building. The proposed Event Centre, located in the southwest quadrant of Lansdowne Park, and the Horticulture Building, situated in the northeast quadrant, are distinctly separated within the park. The proposed Event Centre retains the cultural heritage value of the Horticulture Building and does not impact the existing visual relationship between the Horticulture Building and the Aberdeen Pavilion.

The proposed Event Centre does not present a direct impact on the adjacent cultural heritage resources of the Rideau Canal, QED and the Colonel By Drive cultural landscapes. The Rideau Canal and the QED are recognized by the HCEA as having a contextual relationship with Lansdowne Park and the proposed Event Centre does not present an adverse impact on this relationship.

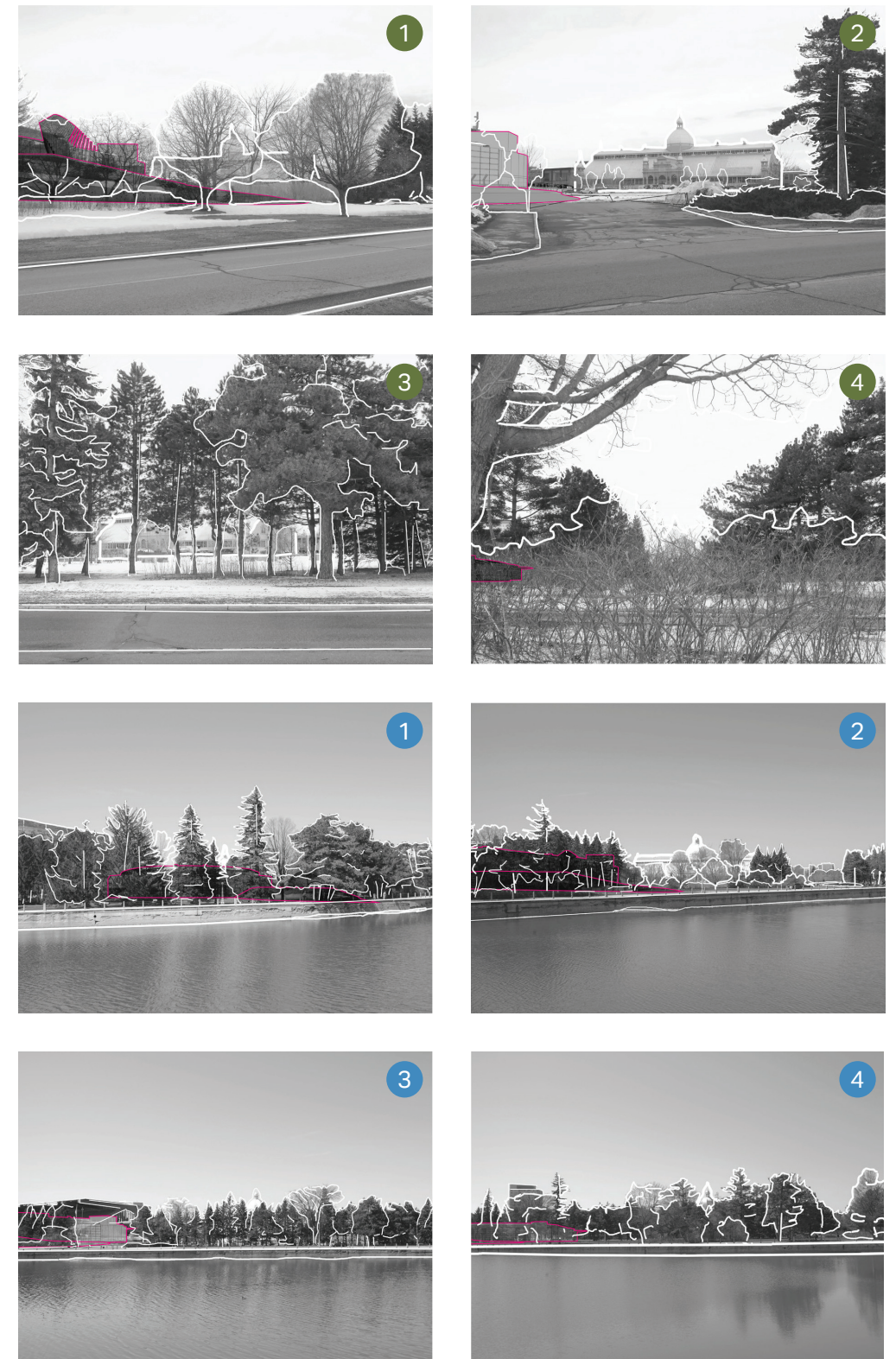

MICROCLIMATE ANALYSIS

The new Event Centre is being constructed to the east of TD Place field, in the current location of the berm. It will have two storeys above ground and one storey below ground.

The curvature of the Event Centre's roof and its perimeter walls will be very minor and gradual, allowing wind to flow freely over and around it. With the Event Centre positioned in the current berm location, the low overall building height relative to grade, and the building profile, the current wind patterns are not substantially impacted.

The proposed Event Centre will be approximately 13.5 metres above grade level. As demonstrated by the Shadow Analysis, the Event Centre's shadow impact is very minor and does not significantly affect the surrounding elements, including the existing North and South stands or the Aberdeen Pavilion.

For these reasons, the proposed Event Centre will not disrupt the surrounding site or existing facilities, nor will it create a new microclimate.

EVENT CENTRE & BERM PROFILES

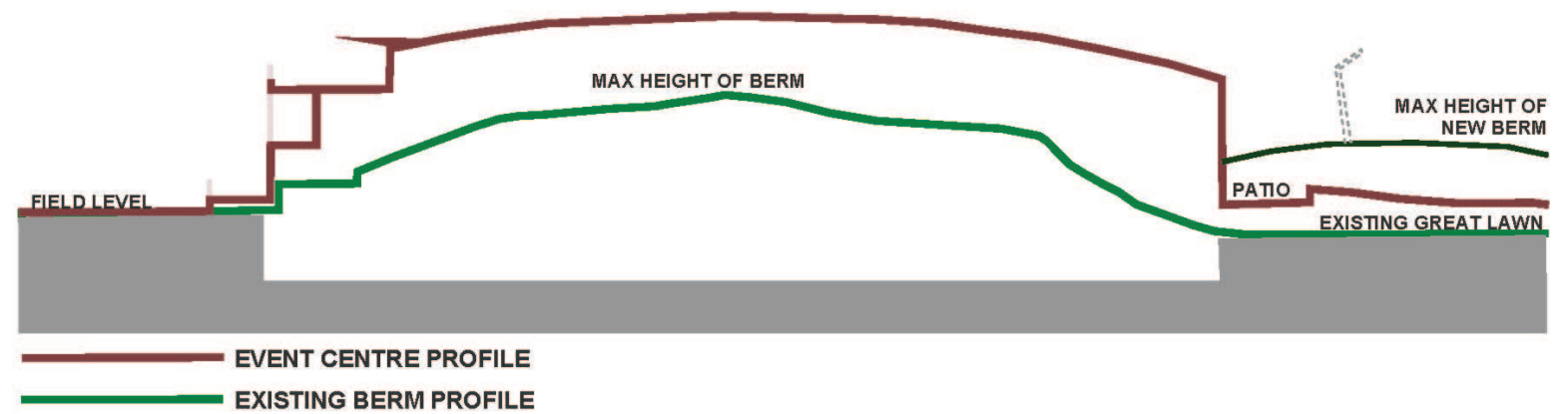

SHADOW ANALYSIS

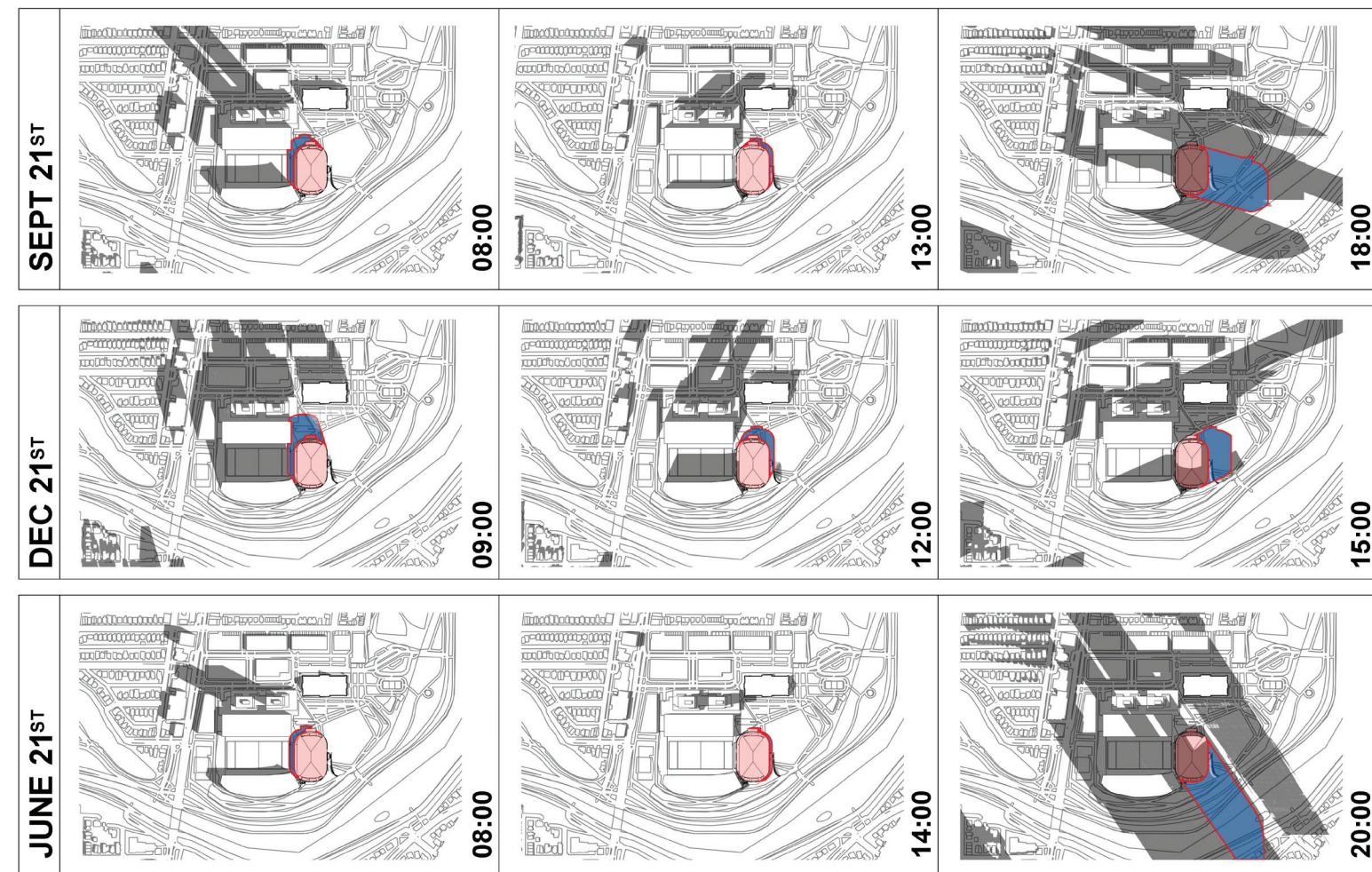

KEY USES & SPATIAL ELEMENTS

The subject property enjoys proximity to a variety of neighbourhood amenities, whether within Lansdowne Park itself, or within the larger Glebe neighbourhood. Amenities include restaurants, bakeries and coffee shops, retail stores, a movie theatre, parkland, schools, and churches. The subject property and surrounding area benefits from access to two (2) grocery stores within 500 metres of Lansdowne Park – Whole Foods Market at 951 Bank Street (within Lansdowne Park) and Metro at 754 Bank Street. The Great Lawn, Lansdowne Skatepark, and Lansdowne Park Skating Rink and Basketball Court all create the municipal park within Lansdowne Park itself, while Sylvia Holden Park, Olympic Garden, Lionel Britton Park, Firehall Park, Brown's Inlet Park and Capital Park, among others, provide for additional municipal and federal parkland that serve Lansdowne Park and the surrounding area. The figure below highlights some key amenities in the area.

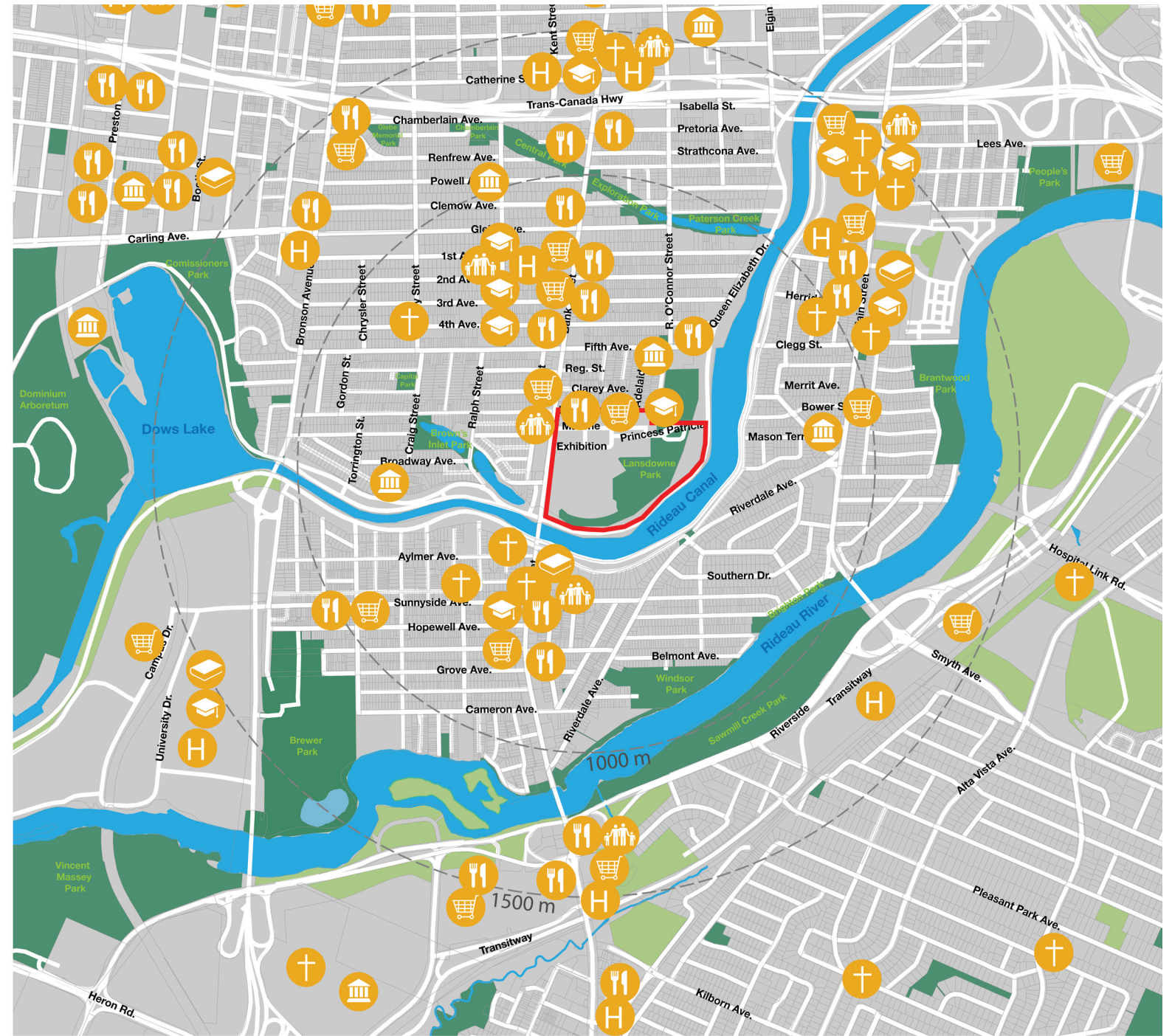
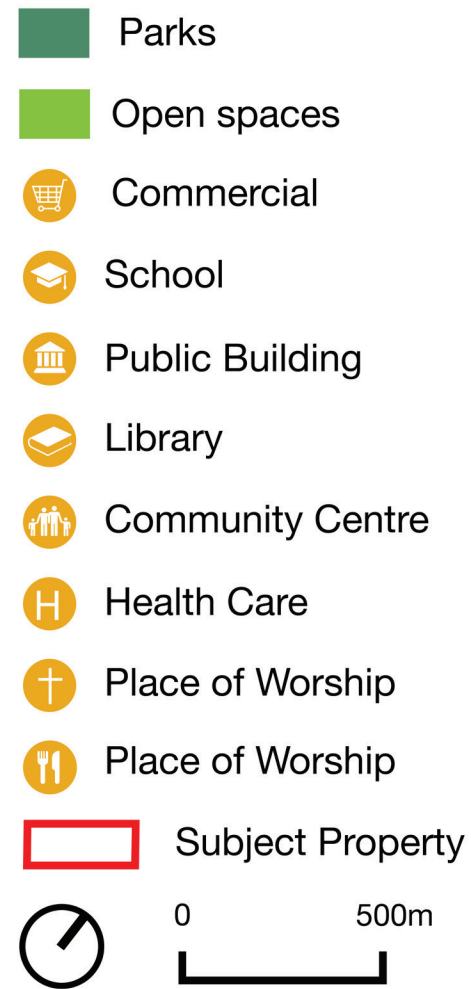

URBAN PATTERN

The sections below illustrate the Event Centre's interaction with the urban pattern of the site's existing buildings, streets and blocks.

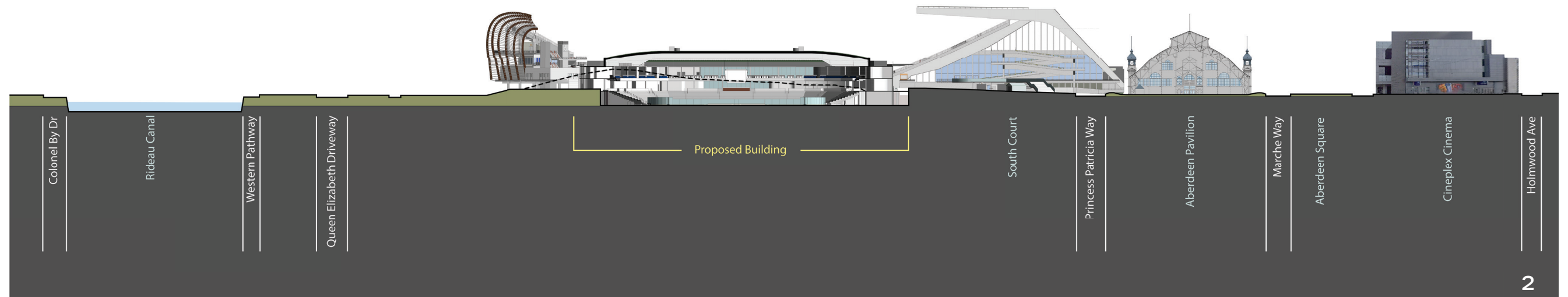
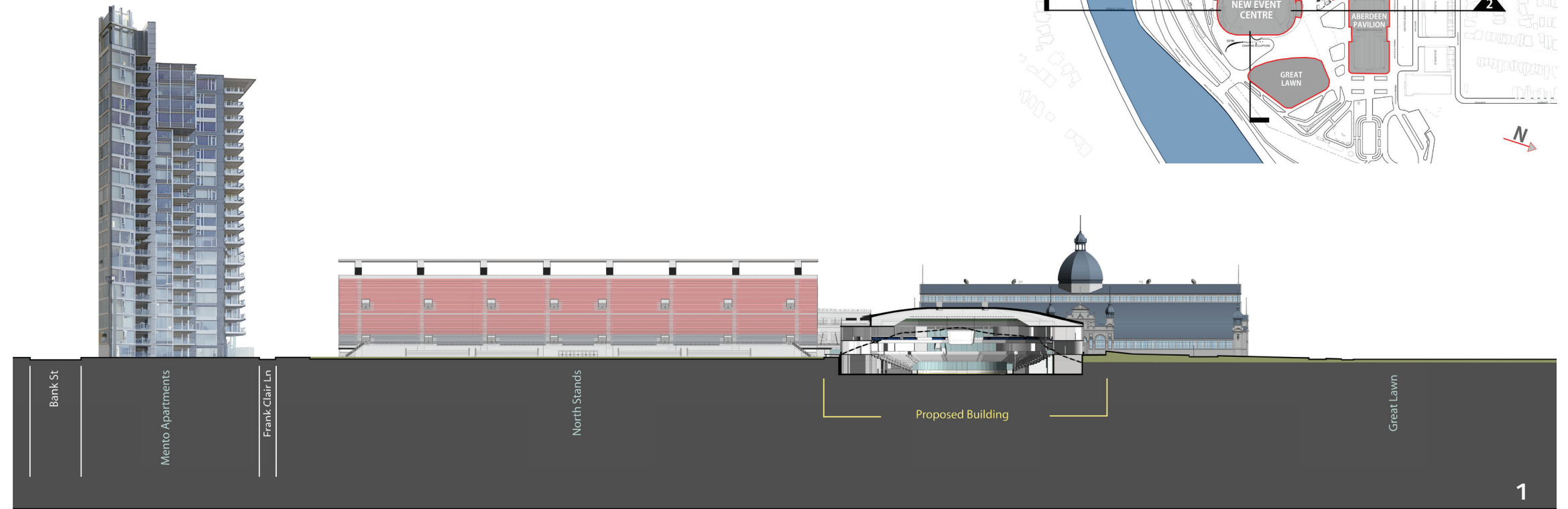
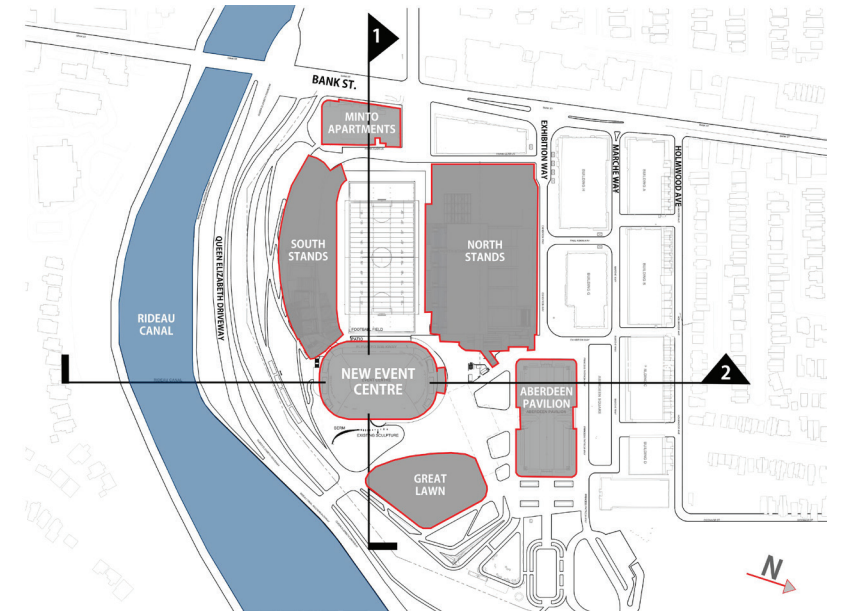

CHARACTERISTIC'S OF PUBLIC REALM

Public realm improvements for sections of Lansdowne Park managed by the City are under consideration, though not necessarily part of the ongoing Site Plan Control application. The improvements and upgrades recommended for the site will provide the City additional options for site programming in the future and simplify the operations of the existing facilities.

The 2022 proposal approved in principle by Council included a dedicated plan for investment in the urban park to improve connectivity to the site and make the park more appealing. The redevelopment program as part of Lansdowne 2.0 includes strategic investment for the publicly controlled portions of the site. Implementation of these improvements will be phased and will require input from the community. Public realm improvements may include:

1. Additional seating in and around park. Park tables and umbrellas to provide more seating and additional shade.
2. Small bandshell for varied events. Portable bandshell for smaller events to attract visitors to the site.
3. Additional covered bike parking New covered bike parking throughout the site.
4. Interpretive panels throughout the site Erect permanent interactive panels throughout the site to display history of Lansdowne.
5. Enhanced delineation of square versus road. Installation of more permanent features that can help delineate the square and make it place for pedestrians.
6. Increased lighting and better sound equipment at skating rink. Enhanced infrastructure around skating rink to support better lighting and sound equipment.
7. Additional storage on-site. Construct an aesthetically pleasing single storey unheated storage unit that accommodate storage for equipment to support events on-site.
8. Bring WiFi to the site. Serves a purpose to track and understand the demographics of those visiting the park.
9. Food vendors. Food trucks and other similar vendors inside the park during events and festivals.
10. Redesigned entrance to the park at Queen Elizabeth Driveway Redesign and reconstruct the entrance to the park to better accommodate cyclists and pedestrians. Consider adding a signalized crosswalk.
11. Forestry Plan for the site which includes a floral plan along the QED. Landscape plan for the entire site, includes a floral plan along Queen Elizabeth Driveway.
12. Provide additional shade. Permanently installed shade sails to encompass all seating areas at the water feature. Long term plan will involve shade being provided by trees, which links to the landscaping plan.
13. Redesign and rebuild of Great Lawn. Reconfigure paved pathways and redefine the berm elevations optimizing the barrier free routes as well as south facing steps.
14. New permanent art feature. A permanent visual draw that can attract visitors to the site and create instagrammable moments.
15. Upgraded electrical across the site A redesign of the lighting plan across the site can support more support varied programming, festivals and concerts.
16. New permanent skate shack This would eliminate the need to rent one every year and can double as storage.
17. More water fountains. Tie this to electrical redesign, and consider water leads and part of design.
18. New play area When time comes for renewal of play area, consider including a water feature or splash pad to the park.
19. Community Garden. New community garden for residents living on-site.
20. Aberdeen roof repairs. Currently in design, construction expected for 2023 under the Capital Budget.
21. Aberdeen climate control - Feasibility Study Undertake a feasibility study to understand what can be done to adjust climate control while maintaining the heritage nature of the building.
22. Aberdeen sound system, masking, lighting, electrical. Recommend undertaking a feasibility study to upgrade infrastructure across the entire site, and a corresponding phasing plan.
23. This connected to item above. To be costed as part of Aberdeen Feasibility Study
24. Venting in Horticulture to support kitchen use. Upgrade kitchen facilities to allow more events to occur.
25. Horticulture sound system. New electrical and audio equipment, with sound masking, could support more events.
26. Access to washrooms Improve access to public washrooms throughout the site. This could include retrofitting buildings to allow access from the outside or create a corridor for public use of washrooms while events are happening.



MOBILITY NETWORKS (TRANSIT)

Transportation Network: The subject property is served by public transit options. As per Schedule C2 – Transit Network-Ultimate, the subject property is located along a Transit Priority Corridor. The nearest bus stop is on the east side of Bank Street, between Exhibition Way and Marché Way in front of one of the existing mixed use buildings on the subject property, and on the west side of Bank Street adjacent to the existing signalized intersection. The bus stops on both sides of the street service OC Transpo bus routes #6 and #7, which are both frequent bus routes, with service every 15 minutes or less on weekdays, and operating seven days per week in all time periods.

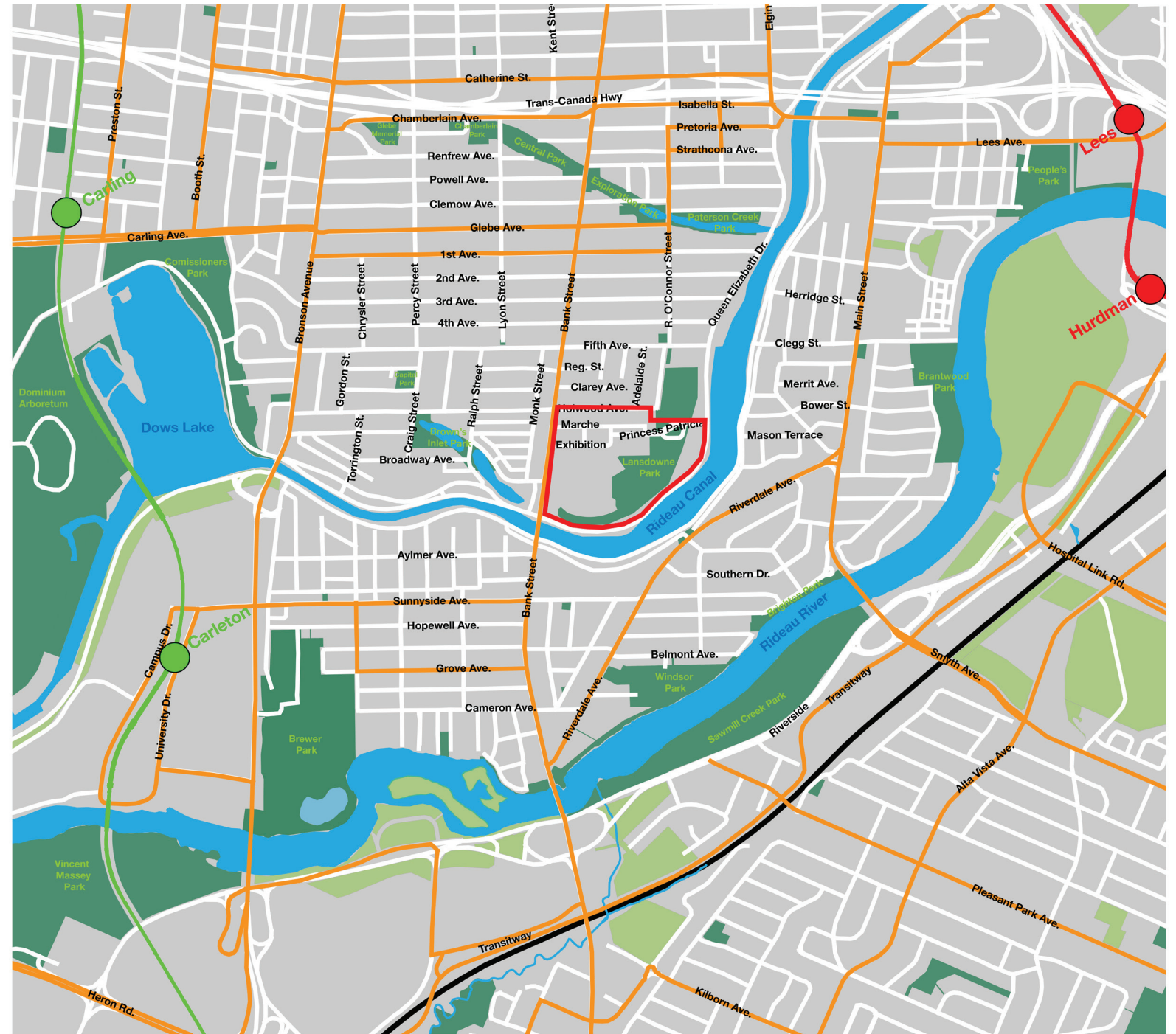
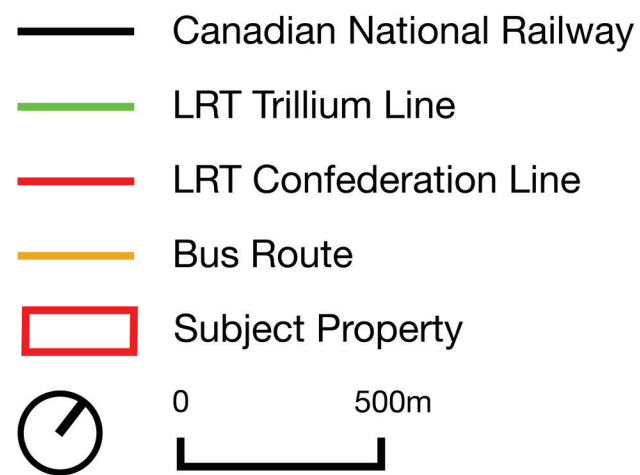

MOBILITY NETWORKS (ACTIVE TRANSPORTATION)

Active Transportation Network: The subject property is well served by the City of Ottawa's planned cycling network and active transportation network, as shown on GeoOttawa and as per Schedule C3 – Active Transportation Network, of the City of Ottawa's Official Plan (Figure 6 and Figure 7). A pathway link is located along the east and south edges of the property, with additional links located at the northeast and southwest corners of the subject property. The pathway link at the northeast corner of the site connects to O'Connor Street, which is an identified cross-town bikeway and cycling spine route. This pathway link also connects to Fifth Avenue, which connects to the Flora Footbridge, an identified cross-town bikeway and cycling spine route. The pathway links around the subject property provide connectivity to the greater cycling network via municipal roads and federally owned lands.

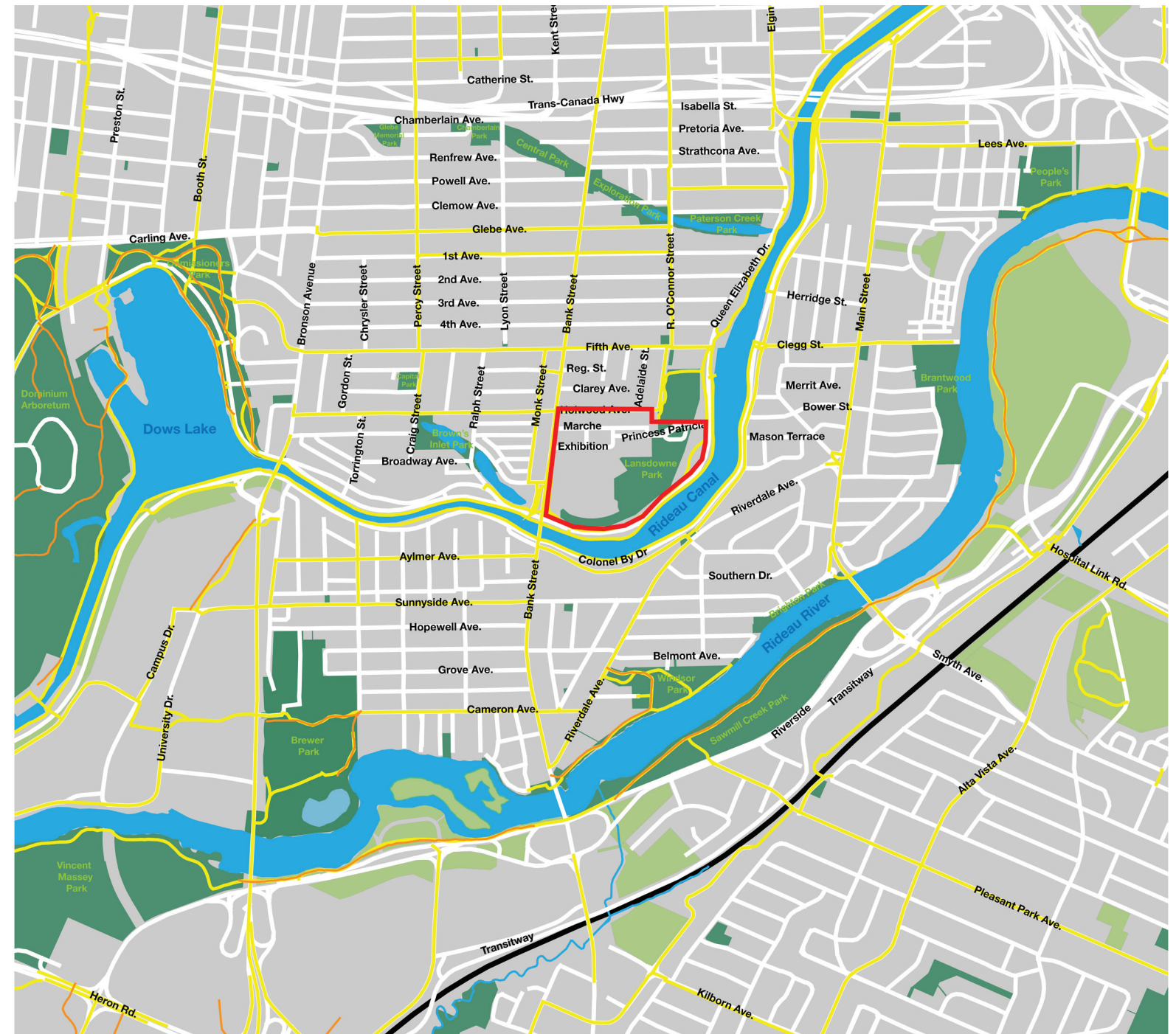
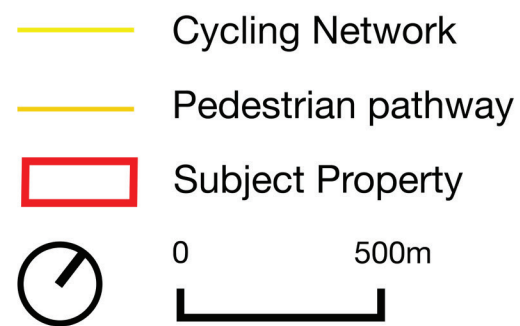

SURROUNDING DEVELOPMENT & PLANNED FUNCTION

Through the ongoing Lansdowne 2.0 redevelopment program, the planned function of Lansdowne Park remains consistent; a mixed-use community hub and entertainment district, consisting of residential, retail and office uses, along with major sports/event facilities, recreational and open space uses.

The area immediately surrounding the proposed event centre is planned to be developed with new north side stadium stands and a new retail podium along Exhibition Way to the north-west of the proposed event centre. Sitting atop the new retail podium will be two (2) residential towers that are zoned for heights up to 40 storeys. The area immediately abutting the Lansdowne Park on Bank Street to the west is planned for taller heights up to twelve (12) storeys directly across from Lansdowne Park, with heights gradually decreasing to four (4) storeys further north on Bank Street, demonstrated by Schedule A of the Bank Street in the Glebe Secondary Plan.

To the south and east, Lansdowne Park directly abuts municipal parkland, and National Capital Commission properties including Queen Elizabeth Driveway, Rideau Canal Mutli-Use Pathway, and the Rideau Canal itself. Given the NCC's ownership of these lands, and their historic significance and heritage classification, no development is anticipated.

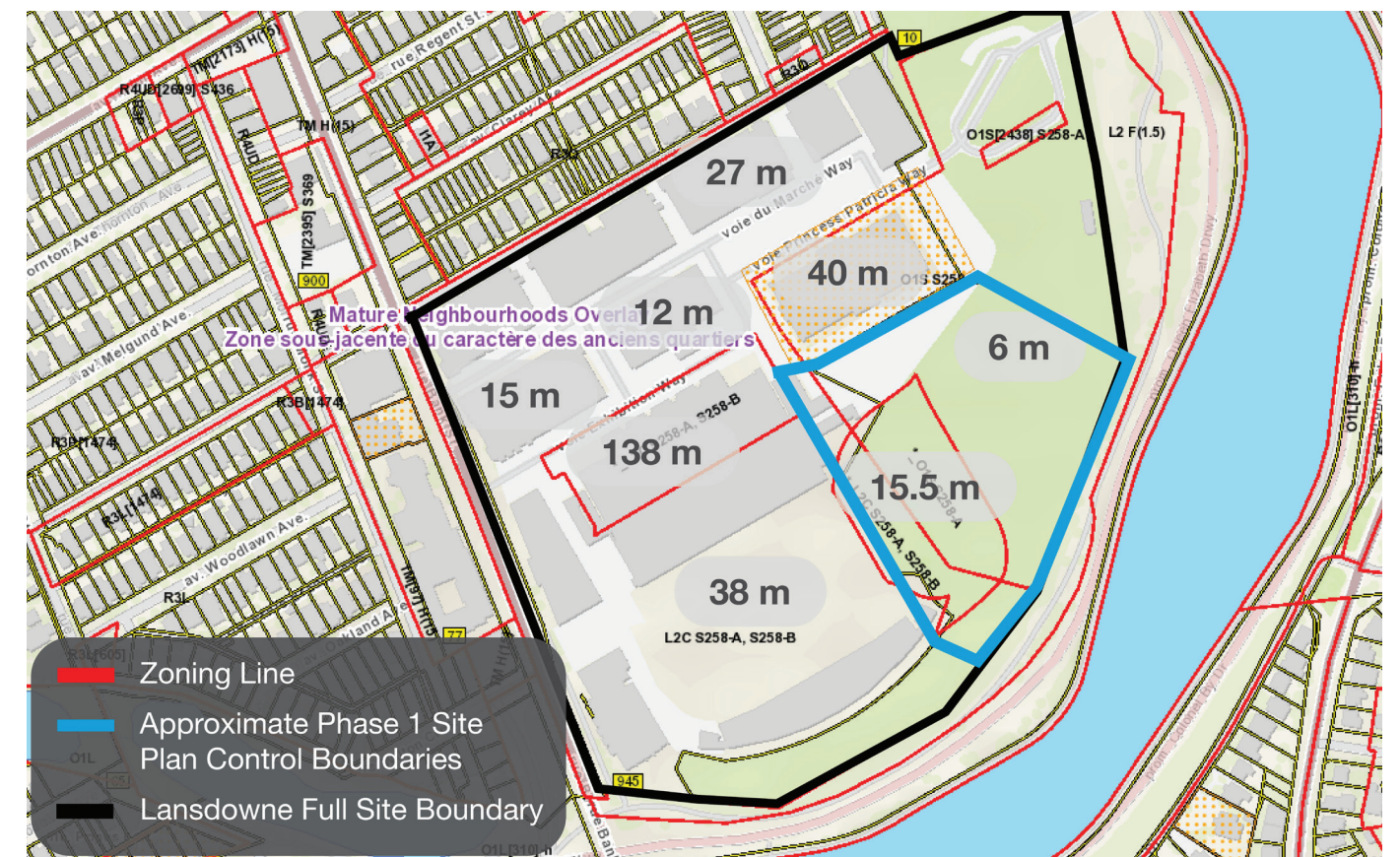
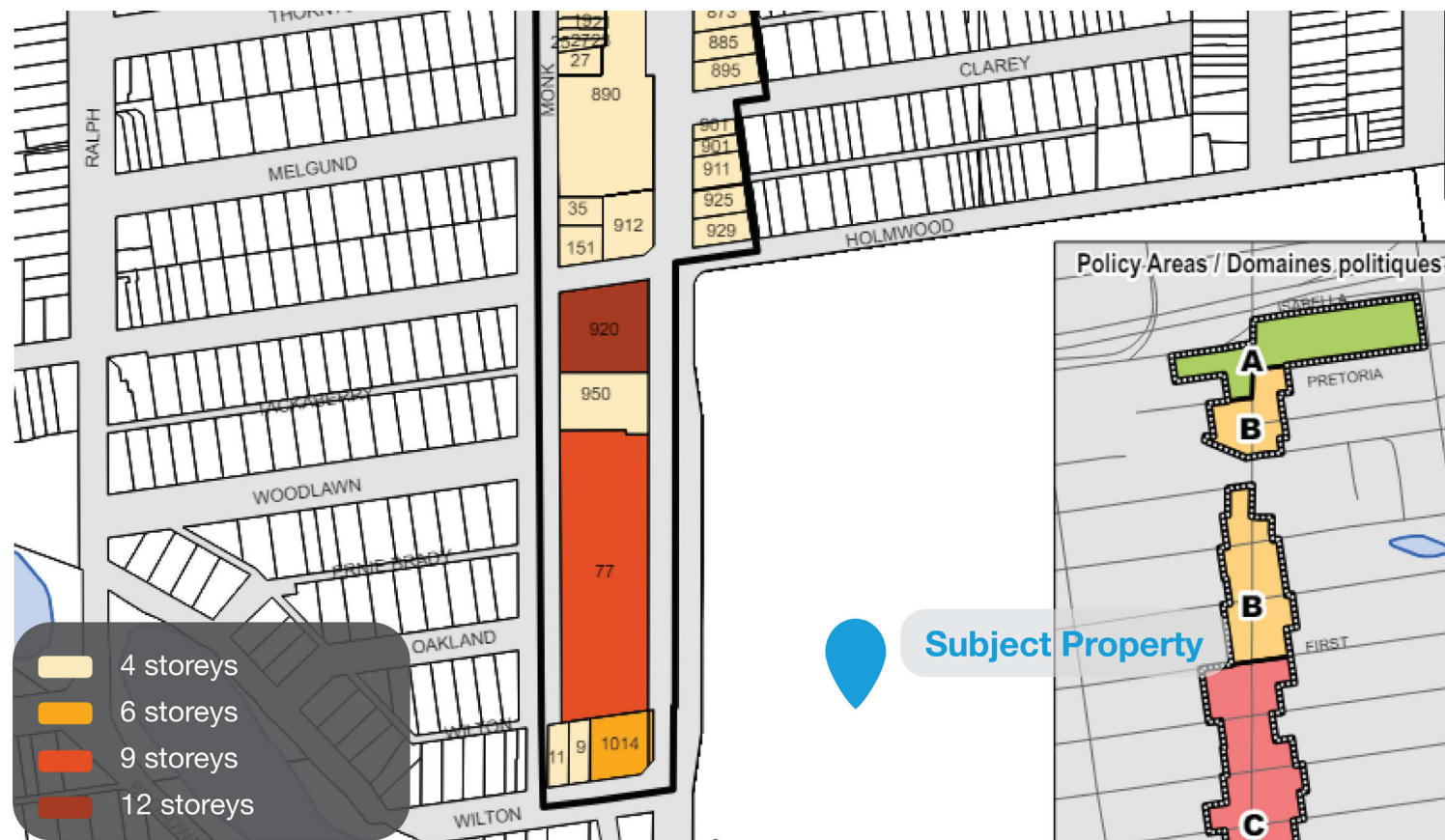

5. DESIGN RESEARCH

PARTI DIAGRAM

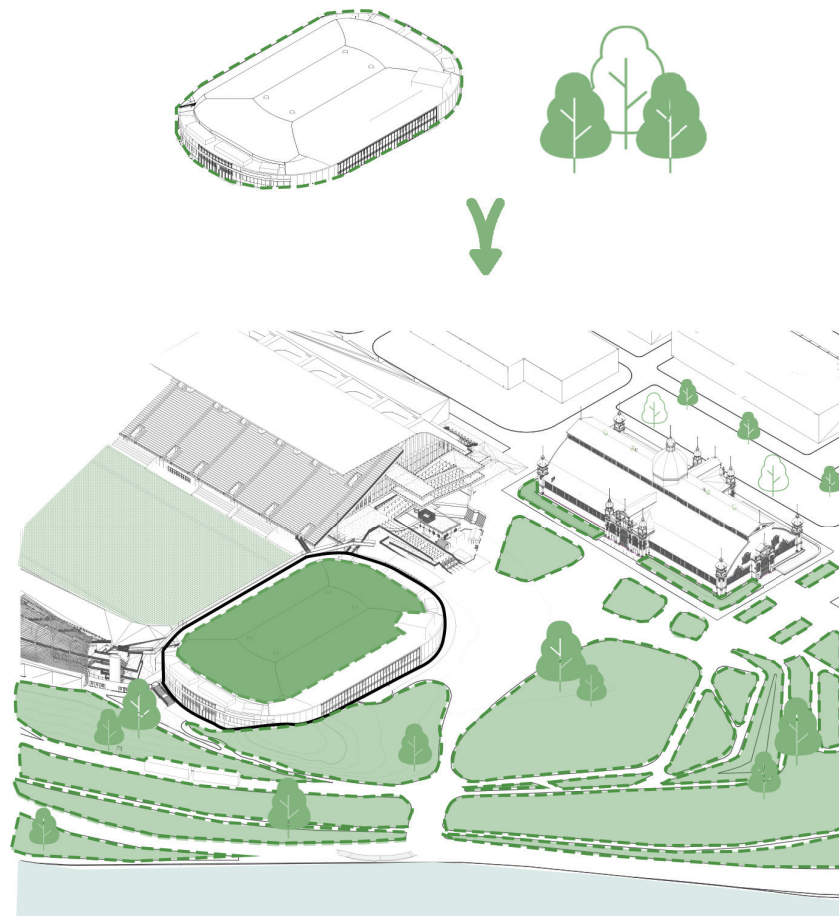

INTEGRATION & CONNECTION

The integration of the Event Centre into Lansdowne Park emphasizes a harmonious blend with the natural surroundings. By preserving and responding to the green spaces around the venue, the design aims to create a seamless transition between the built environment and the natural landscape. The inclusion of trees and open areas ensures that the Event Centre complements the area's aesthetic and historical value, offering a venue that not only serves its primary function but is sufficiently rooted in Lansdowne.



A DYNAMIC & MULTI-USE HUB

The Event Centre is designed as a versatile multi-use venue, catering to a diverse range of activities and events. This multifunctional approach includes facilities for sports such as hockey, spaces for concerts and cultural performances, areas for community gatherings and social events, as well as amenities like cafes and restaurants. By accommodating various types of events, the Event Centre becomes a dynamic hub that serves different segments of the public, enhancing its utility and ensuring continuous engagement throughout the year.

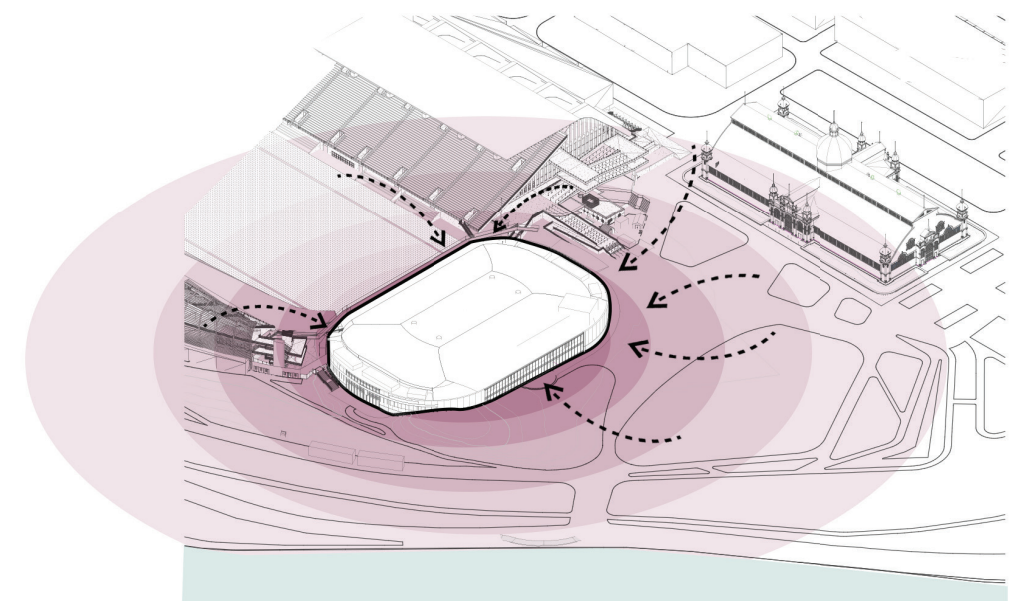

A GATHERING POINT

The concept of creating a gathering point is central to the design of the Event Centre, which aims to serve as an attraction point for the community. Strategic pathways and access routes ensure easy movement and connectivity. The green and public spaces around the Event Centre are designed to facilitate social interaction, making it a vibrant center of activity. This design not only supports the Event Centre's primary functions but also fosters a sense of community by providing a welcoming space for people to come together.

ARCHITECTURAL PRECEDENTS

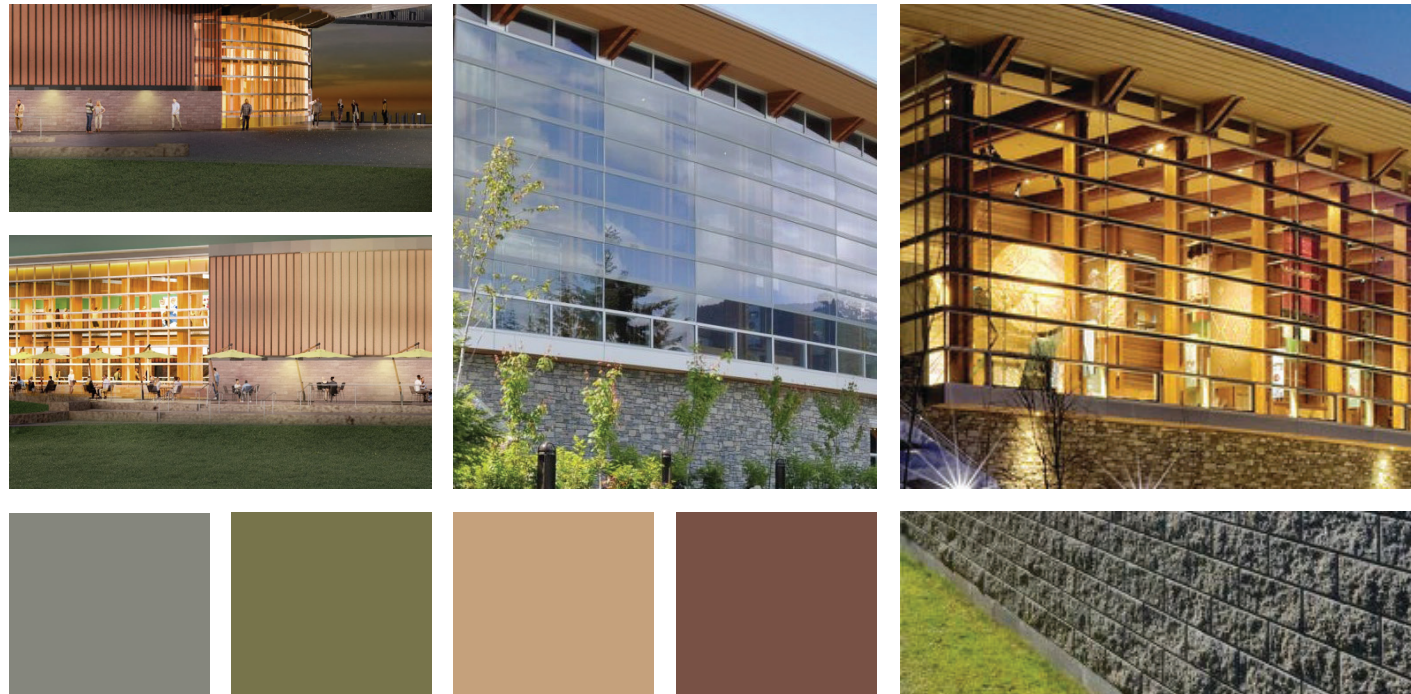

LANDSCAPE ARCHITECTURE PRECEDENTS



DESIGN EVOLUTION

Many options were explored for the Event Centre and its adjacency to the berm. The design explored various options such as no berm, varying heights of the berm, and different extents. Additionally, the Event Centre evolved in conjunction with its impact on the view corridor of the Aberdeen Pavilion.

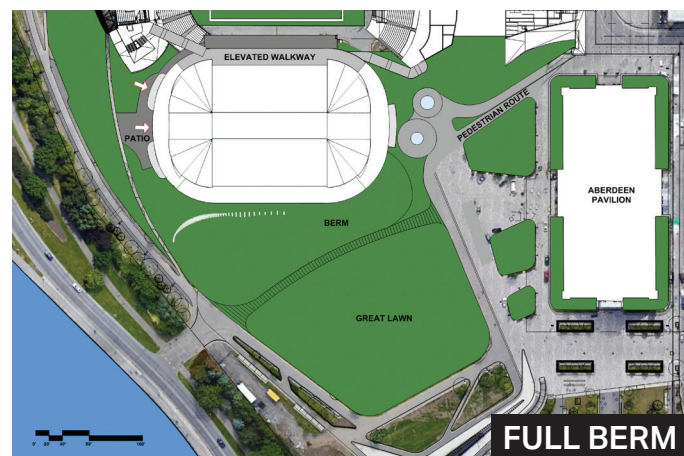

FULL BERM



NO BERM + FULL ACCESS PATIO

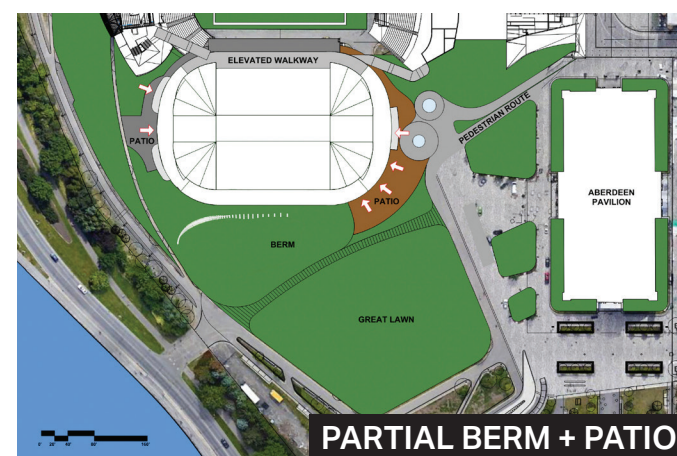

PARTIAL BERM + PATIO

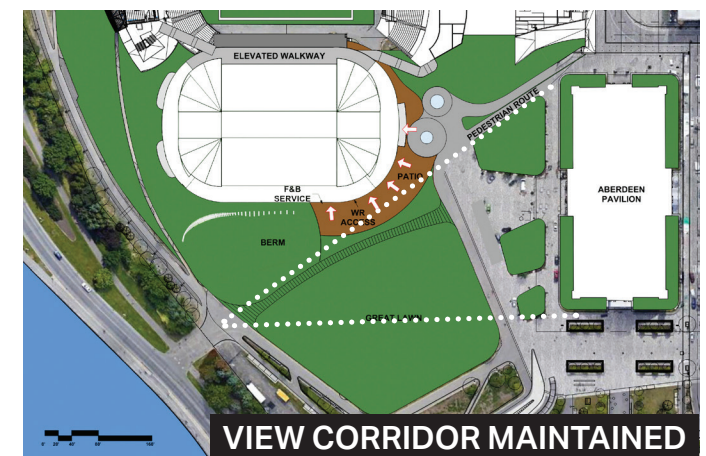

VIEW CORRIDOR MAINTAINED

PUBLIC REALM LANDSCAPE

The new landscape entities surrounding the Event Centre provide the framework which ties together the existing Lansdowne urban public realm, the TD Place, proposed Event Centre, Aberdeen Pavilion and the Great Lawn.

A continuity of materials and landscape features such as raised planters, seating walls, paving materials, lighting and site furniture provide a unified design which transitions from the urban landscape character of Exhibition Way to the softer landscape spaces surrounding the Event Centre.

The new plaza space which connects the two forecourts of the Event Centre and the Pavilion is enlivened by a raised, elliptical lawn serving as a festive, gathering and performance space. A low seating-wall with benches runs around the perimeter and is accompanied by planters that separate the flow of vehicles giving emergency access to the stadium and the drop-off area from the rest of the pedestrian realm.

To the east of the Event Centre, tiered steps provide a transition to the park, with elevated views across the Great Lawn from both the berm and tiered seating elements. The design employs the highest level of universal accessible design standards which will be carried through to detailed elements such as paving materials, signage, wayfinding and lighting.

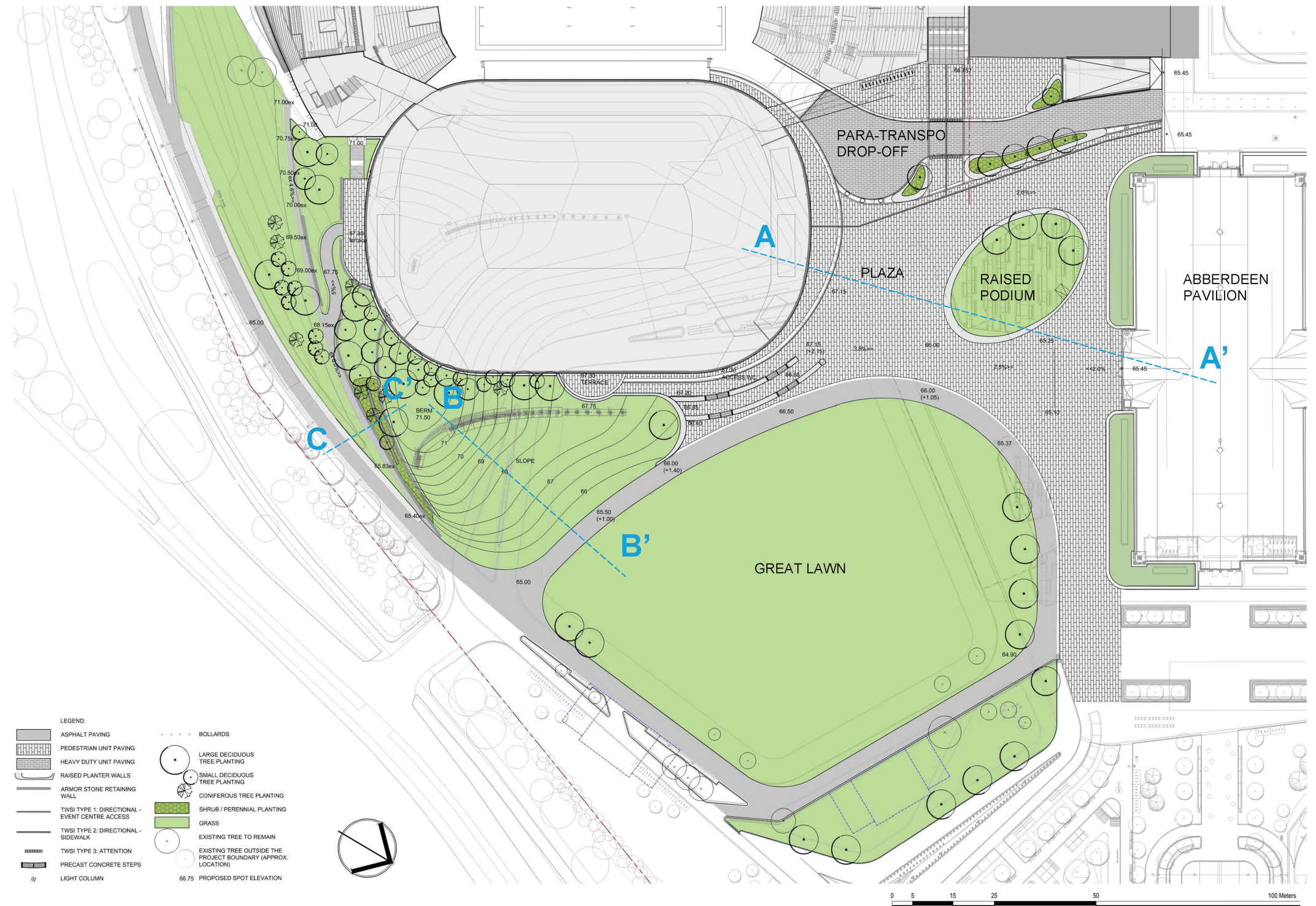

PUBLIC REALM LANDSCAPE

Tree and shrub planting has been designed to ensure important surrounding heritage views to the Aberdeen Pavilion are maintained, while providing opportunities for large deciduous shade trees with supporting soil volumes. Robust tree and shrub planting is proposed along the South and West side of the berm as a backdrop to the Moving Surfaces sculpture and as a continuation of the tree canopy adjacent to the NCC pathways and Rideau River.

Finally, the Great Lawn is maintained and expanded to the North for flexible programming of the site, while providing a visual link between the Event Centre and the Aberdeen Pavilion.

The design intent for the Landscape space is to provide a vibrant public realm which can accommodate large public gatherings and facilitate community events while also providing an attractive landscape setting to be used for passive recreation by members of the surrounding community and visitors to Lansdowne during non-event periods.

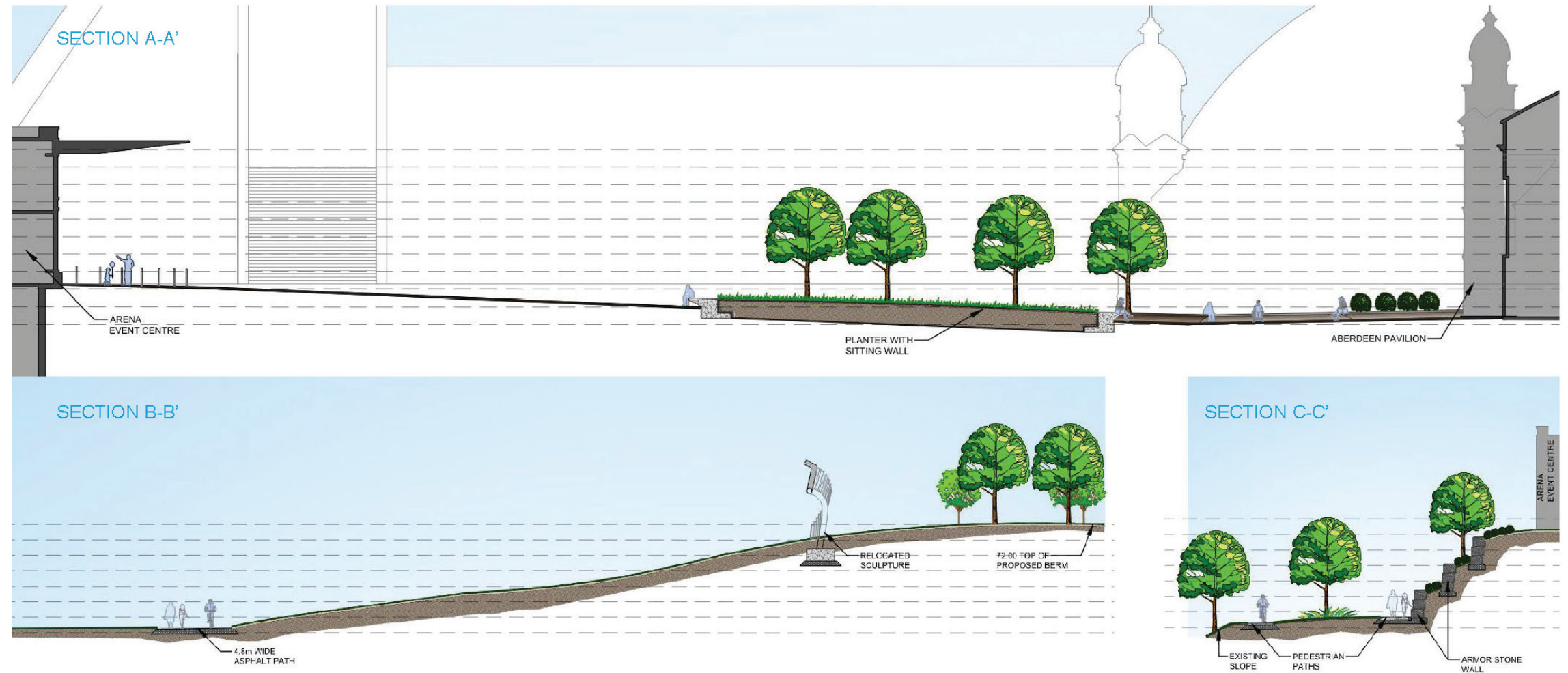

PUBLIC REALM CIRCULATION

LANSDOWNE 2.0 — INTERNAL CIRCULATION CONCEPT PLAN

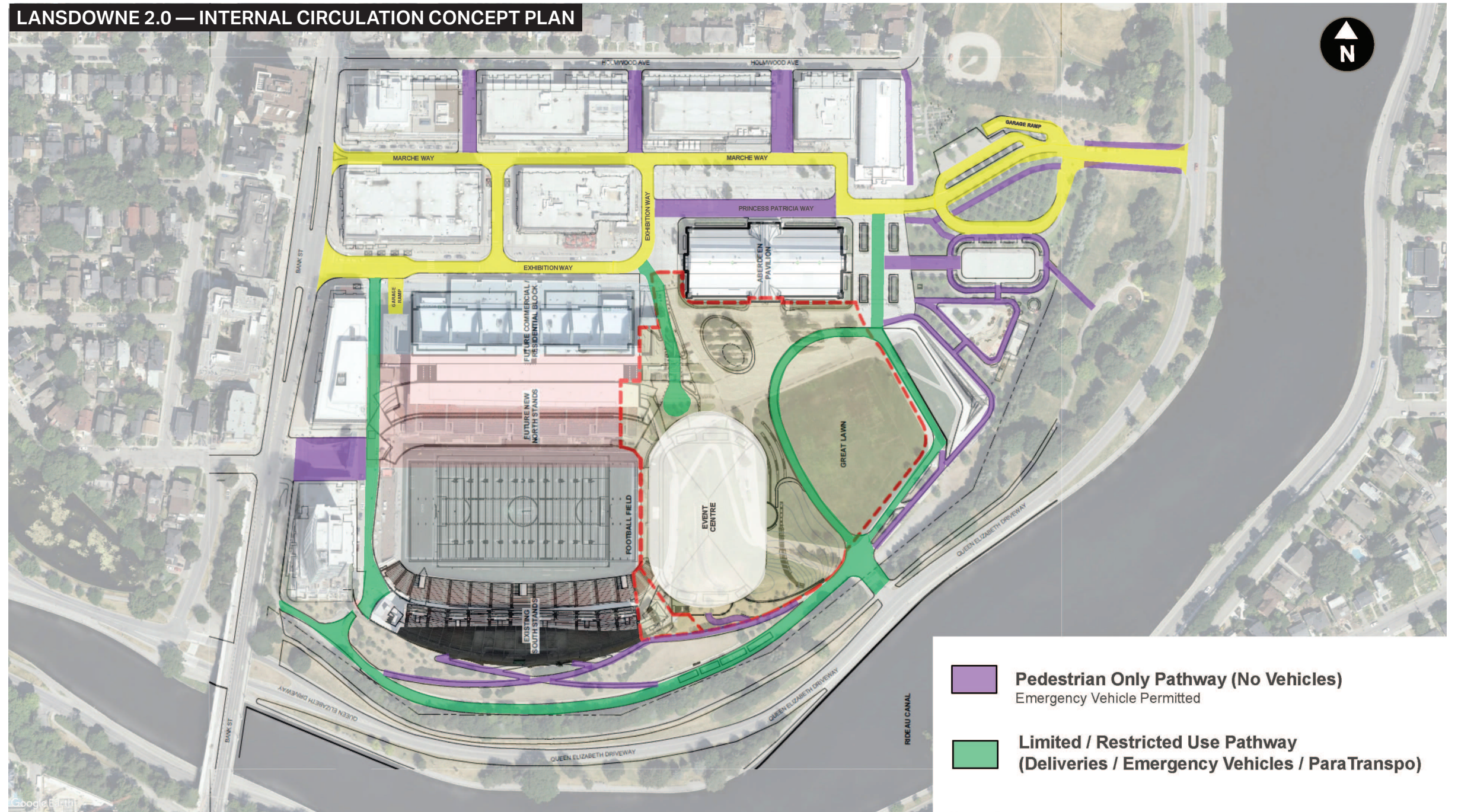

Not to Scale

- Pedestrian Only Pathway (No Vehicles)**
Emergency Vehicle Permitted
- Limited / Restricted Use Pathway (Deliveries / Emergency Vehicles / ParaTranspo)**
- General Public Vehicular Access / Circulation**

MASSING OF PROPOSED DEVELOPMENT (EXISTING)



MASSING OF PROPOSED DEVELOPMENT (FUTURE)



EVENT CENTRE WITH PHASE 2 NEW NORTH SIDE STANDS MASSING — NORTH



EVENT CENTRE WITH PHASE 2 NEW NORTH SIDE STANDS MASSING — SOUTH



EVENT CENTRE WITH PHASE 2 NEW NORTH SIDE STANDS AND PHASE 3 MIXED-USE DEVELOPMENT MASSING — NORTH



EVENT CENTRE WITH PHASE 2 NEW NORTH SIDE STANDS AND PHASE 3 MIXED-USE DEVELOPMENT MASSING — SOUTH

BLOCK PLAN FUTURE DEVELOPMENTS

The Lansdowne 2.0 project is presently broken into three phases, with the Event Centre and Landscaping being captured in Phase 1. Subsequent phases will include the development of the new North Side Stands and Grand Stairs (Phase 2), followed by the addition of two residential towers and retail/commercial space (Phase 3).

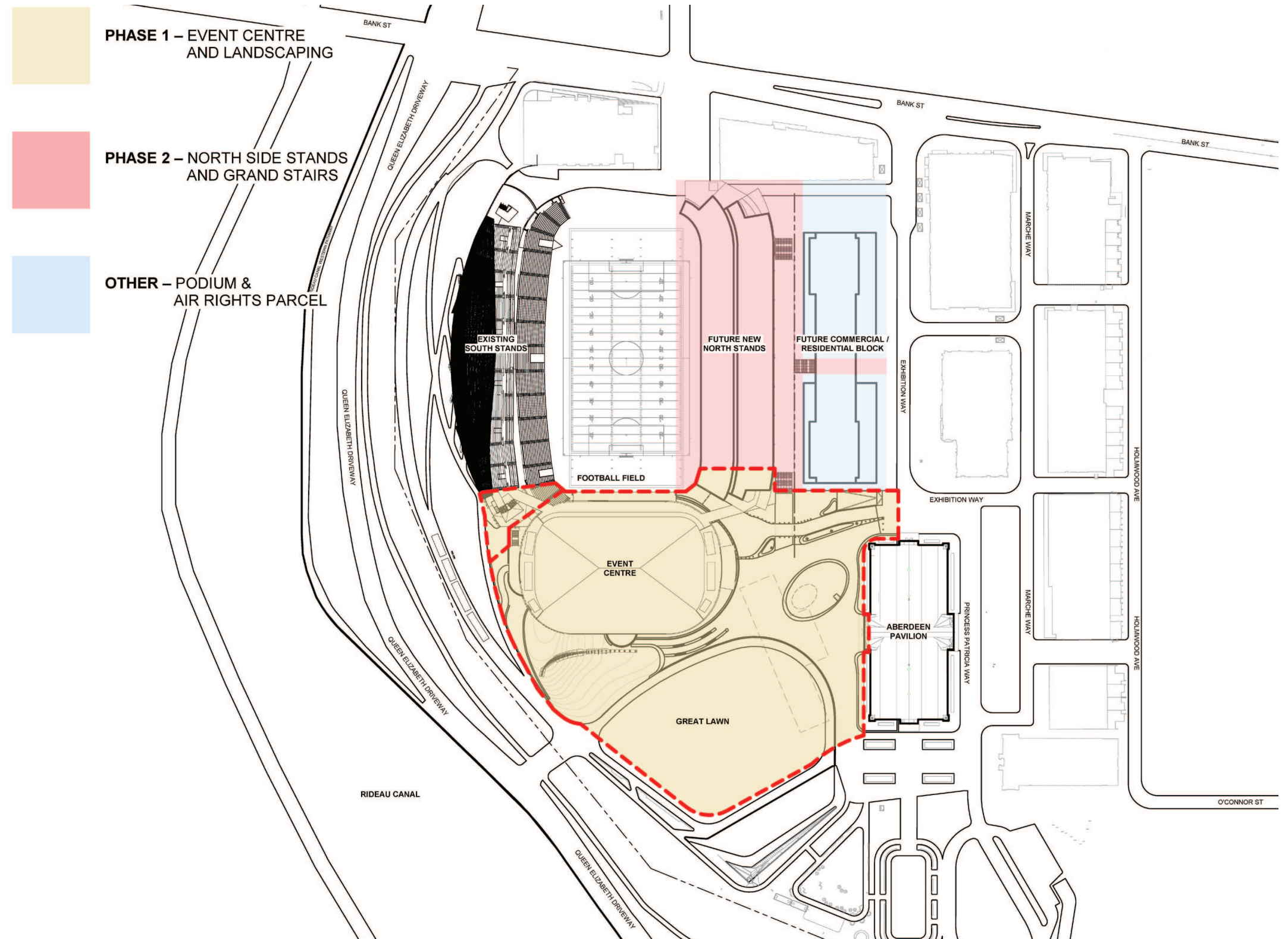

SUSTAINABLE DESIGN

HIGH PERFORMANCE DEVELOPMENT STANDARDS

The proposed development of the Event Centre is designed in conformance with the City's High Performance Development Standards. The Event Centre Site Plan Tier 1 Metrics are as outlined:

Building Energy Efficiency

Mechanical: The building will use a heat pump system which allows it to share heating and cooling energy between different areas in the building. The heat pump loop will be utilized to provide heating and cooling to the building and to recover heat from the ice plant. The building envelope will be designed to meet ASHRAE and local code requirements for insulation and performance. Demand control ventilation will be deployed throughout the building to ensure that ventilation is provided only in the quantities required based on occupancy of the building saving energy during low and unoccupied times. High-efficiency condensing boilers will be used to provide additional heat to the building if there is insufficient recovered heat from the ice plant. Variable speed drives will be provided on all pumps and fans to ensure minimal energy consumption of these devices. Where possible, free cooling will be utilized to maintain interior space temperatures during the winter and shoulder seasons.

Electrical: The electrical design for the Project will provide efficiency, reliability, ease of maintenance and flexibility through robust and secure power distribution systems of sufficient capacity and redundancy; and will support the immediate, short-term and long-term requirements of the functional technologies and functional programs identified for the event centre.

The electrical systems will be coordinated to minimize interferences while maximizing efficiency e.g. vertically stacked electrical and IT riser rooms that will be strategically located centrally to service the program areas, whereas mechanical shafts will be located to ensure there are minimum crossings between mechanical and electrical services. This process will enable the team to optimize systems and reduce operating and maintenance costs. Some specific electrical strategies that will be implemented to fulfil this goal include:

- most efficient and effective use of all power distribution components to ensure major components such as the power transformers and associated switchgear are not left idle;
- all electrical equipment is provided with sufficient clearance, access routes and panels to allow for easy removal and replacement;

- adequate space, spare capacity and cable pathways are provided to allow for future use;
- selection of electrical equipment from reputable manufacturers based upon lifecycle, energy efficiency, maintenance, accessibility and serviceability;
- lighting systems design with effective application of natural lighting c/w daylight harvesting sensors to dim or turn off lights where possible;
- high efficiency and high colour rendering LED lamps and energy saving electronic drivers complete with an average lamp life of 50,000 hours that minimizes material use and failures;
- luminaires that meet CUL/CSA and LM-79 and LM-80 standards, complete with 5-year warranties on all components, and are Energy Star qualified;
- lighting controls that provide flexibility, easy set up and quick reconfiguration of program spaces.

Site Plan Accessibility

The accessibility document developed for the site provides directions and guidelines to achieve the highest universal accessibility standards for the outdoor environment, be it in the mixed-use, the urban park or around the Event Centre. The document also speaks to considerations for accessibility for other disciplines as well such as lighting, transportation, public art and interpretation and signage and wayfinding. It also identifies accessibility challenges that are often found in developments, and ways in which the project team can implement best design practices and sets out a process where the detailed design development and construction would be undertaken through a compliance review process to ensure that the highest possible universal accessibility standards have been met.

Lansdowne 2.0 site demonstrates a sustainable universally accessible site that is inclusive of all people. Universal Design principles will inform the requirements of the site as a whole and will be an integral component of each separate design element. Taking a comprehensive accessible design approach to the entire site and applying Universal Design principles to all of the site elements ensures a cohesive and symbiotic relationship between individual elements and the neighborhood as a whole. In addition, each built design element of the site, from the stadium and the Event Centre to the mixed use and residential components will be evaluated using a universal design lens to ensure it is accessible to all possible users.

Fresh Air Intake

The intakes will be located above grade in areas that are not accessible to the public. They will maintain the required clearances to all exhaust outlets and other building openings. The intakes will be protected with louvres, bird screens and other measures to ensure the function as designed.

Tree Planting

A substantial tree planting strategy is a key element of civic infrastructure that enhances the attractiveness, comfort and safety of the public realm. Not only do trees elevate civic status, they help to mitigate urban heat island effects, filter the air, absorb and filter stormwater, and provide habitat. They also slow the pace and intensity of street activity and reduce pedestrians' perception of traffic volume and speed, ultimately creating more desirable places in which to linger and socialize. Close attention should be paid to the conditions in which they are planted and to their long-term maintenance. Robust tree plantings will establish a new and consistent identity throughout Lansdowne and will serve to connect the Mixed-use zone to the Event Center. Important considerations for the tree strategy are:

- A large canopy of broadleaf deciduous trees should be selected for disease resistance, distinct winter form and a continuous overhead canopy.
- Coniferous trees should not be used in the pedestrian realm for visibility, microclimate and safety reasons. Most trees proposed are deciduous trees.
- Native or adapted species with low watering requirements should be used wherever possible.
- Species should be selected to provide shade and cooling during summer and wind protection in winter and should be appropriately matched to urban conditions.
- Street trees should be planted in subsurface soil volumes that are sufficient for the growth of substantial, healthy tree canopies. Structural soil cells or equivalent should be utilized to maximize root access to required soil volumes. Where continuous trenches and soil cells aren't feasible, structural soils or equivalent should be used.
- Where trees are planted over slab, sunken slab or other structural strategies should be used to enable sufficient soil volume for tree planting.

- To enhance the livability of the public realm without excessive clutter, the use of raised planters should be avoided unless their use enhances the design of the public realm (such as taking up grade or providing seating).
- Shrubs and perennials should be native or adapted species with low watering requirements. They should be selected for their contribution to the form, performance, and connection to the park.

Plant Species

The trees selected for the Lansdowne 2.0 project have been chosen based on their connection to the existing Lansdowne site and their environmental value. The pallet uses trees that are either native or disease resistant varieties of native trees. The proposed trees also reflect the species that are currently doing well on the site while taking new site conditions into consideration.

Exterior Lighting

Perception of Safety - Night lighting must provide a level of visibility which is suitable for the intended activities in the space. Full colour, glare free light is required for movement in otherwise dark environments. People need to be able to see in all directions to sense danger and to have a feeling of security. The psychological perception of safety is as important as actual protection from danger.

Brightness management - It is essential to understand how the eye perceives the effect of light at night. People see the brightness of light reflected from a surface. It is the impact of the relative brightness and relative colour that gives visual recognition. Good lighting design is the management of the relative brightness. Excessive relative brightness becomes glare and restricts ones ability to see. Glare is to be avoided.

Adaptation - As people move from one space to another, adaptation time is required for the eye to adjust to changes in light quantity.

Vertical Illumination - Lit vertical surfaces provide silhouetted revelation of form especially as people are seen moving against the lit background. Vertical illumination on people's faces is essential throughout the public realm to allow for safe recognition. Most of the spaces and pathways at Lansdowne 2.0 will require light from sources above head height.

Lighting Fixtures - Lansdowne 2.0 offers a challenge and opportunity to answer many of the, sometimes conflicting, lighting requirements with an innovative solution. Today's environmental issues of wasting

light energy combined with new LED technologies (2500-3000 °K), combined with safety and wayfinding, all add up to a role for a lighting solution.

General Lighting Hardware - Except for featured lighting fixtures, lighting hardware should be chosen from the catalogs of time tested, major manufacturers. If custom parts or modifications are required the availability of a product over a long time period must be considered. It is a good strategy to acquire and store additional fixtures.

Energy Efficiency - We will specify the correct efficient light source that will meet all the visual requirements, thereby helping people to see and feel comfortable

without using more light than is absolutely necessary. If the light does not meet these needs it is not saving energy. The most successful lighting designs use light only where needed for the task, for the periods of time required and they use it as little as possible. The lighting control system will assist in saving energy by turning lights off and on as required for various functions.

Bird-Safe Design

The following bird-safe design elements to be implemented are included in the next section of this report.

Sustainable Roofing

The roof will be an EnergySmart membrane roof.

Cool Landscape and Paving

Paving is the most pervasive element connecting the Event Center to the Mixed-Use Zone, thus creating a new plaza and large gathering space. Coordinated paving materials, paver dimensions, colours, and textures contribute to the visual coherence of the overall site by communicating distinct streetscape activity and transition zones. Throughout the site, all paved surfaces will be articulated as public spaces, safe for loading areas. Different paved surface typologies hold differing performance criteria. The paved surfaces within the site include vehicular traffic, shared vehicular and pedestrian zones, pedestrian-only zones, and pedestrian paths (formal, informal and fine-grained).

- The project is targeting non-roof impervious surfaces to have an SRI (Solar Reflectance Index) greater than 29. High albedo (light-coloured) pavers and concrete will be used to mitigate the urban heat island. Colour and finish will be coordinated through Detail Design and to match Exhibition Way guidelines.

- Paving types should be differentiated through integral distinctions rather than temporary applications.
- Pedestrian crosswalks shall be distinguished through slight paving variation and the use of banding to communicate pedestrian access.
- Durability to snow clearing equipment, freeze-thaw cycles and general wear and tear should be of high priority. Load requirements will be met for all paving types through appropriate base courses, materials and thicknesses.
- Tactile wayfinding surfacing for accessibility will be coordinated and integrated with paving so as to be part of the overall paving pattern. The sidewalk should be continuous across private vehicle access and egress points so vehicles do not interfere with pedestrian priority.
- Where not over slab, a rigid base course should be used for stability and drainage.
- Accessible crossings should be clearly communicated but integrated into the overall paving pattern and colour scheme.
- The areas accessible to vehicles are clearly communicated through a hierarchy of paving types and layouts.

Common Area Waste Storage

There is an interior common waste and recycling storage area located on Level 1.

Electric Vehicle Parking

Electric vehicle parking will be included in the second phase when the parking garage is constructed.

Bicycle Access and Storage

Exterior bike supports are provided near the main Event Centre entrance.

LEED® CERTIFICATION

Additionally, the Event Centre will target LEED® certification, which implements a point system across several categories, including energy efficiency, water usage, sustainable site development, material selection. Sustainable strategies for the Event Centre may include implementing a high-performance building envelope, efficient lighting, heat recovery, external shading, daylight harvesting, natural ventilation, low-flush fixtures, rainwater capture, enhanced energy metering, and advanced control systems allowing facility operators to adjust energy consumption based on power needs at any given time.

BIRD SAFE DESIGN GUIDELINES

The following bird-safe design elements will be implemented to reduce risks to birds:

- Use of specified bird-safe glass or integrated protection measures to treat at least 90% of exterior glazing within the first 16 m of height or to the height of the adjacent mature tree canopy.
- Use of specified bird-safe glass or integrated protection measures to treat any glazing adjacent to a green roof, rooftop garden or garden terrace to a height of 4 m or to the height of the adjacent mature vegetation.
- Elimination of fly-through effects (e.g., glass corners, parallel glass) and other traps from building design or use specified bird-safe glass or integrated protection measures.
- Adherence to bird safe glass that follow these specifications:
 - High colour contrast to the glass surface.
 - Application to the exterior (first) surface of the glass.
 - A visual marker (i.e. lines, dots, etc.) with spacing of 50 mm by 50 mm is used.
 - Individual marker elements with a minimum of 4 mm diameter, or 2 mm wide by 8 mm long for linear elements.



APPENDICES

- A) Site Plans Phased & Detailed
- B) Floorplans & Elevations
- C) Landscape Plan
- D) Grading and Drainage Plan
- E) Site Servicing Plan
- F) Shadow Analysis
- G) Wind Analysis
- H) Heritage Impact Statement

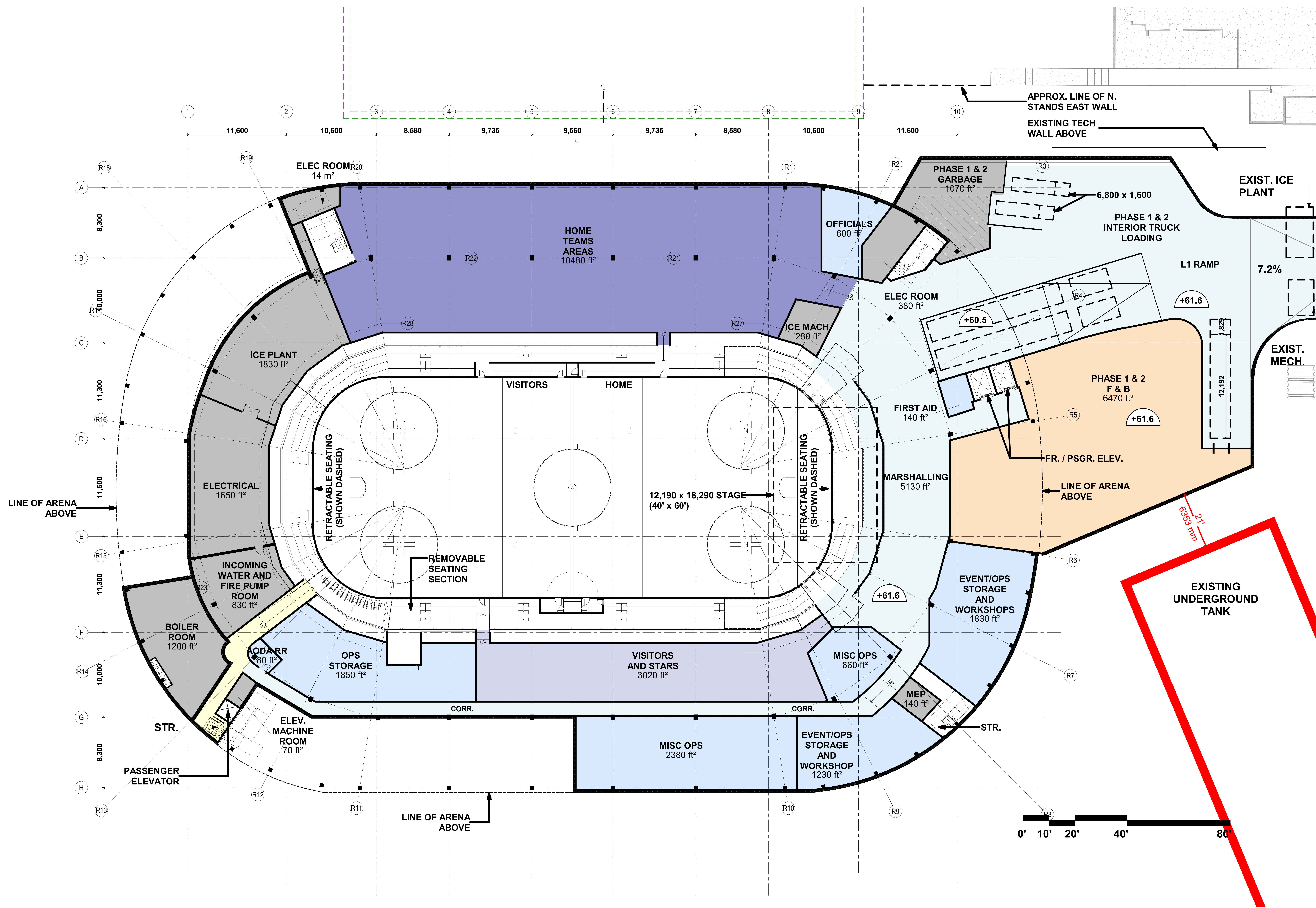

IN PROGRESS

TOTAL EC BLDG AREAS WILL BE REDUCED TO 160,000sf TO MEET BUDGET. NNS AREAS IN EC PROGRAM & ON THESE PLANS ARE APPROVED TO PROCEED IN THIS EC PHASE. DISTRIBUTION OF FUNCTIONAL SPACES ARE FIXED.

DATE: 2024-06-03

1 of 12

**LANSDOWNE EVENT CENTRE
L1 OVERALL PLAN**
Schematic Design

**BRISBIN
BROOK
BEYNON** ARCHITECTS

DATE PLOTTED: 2024-06-26 1:45:28 PM

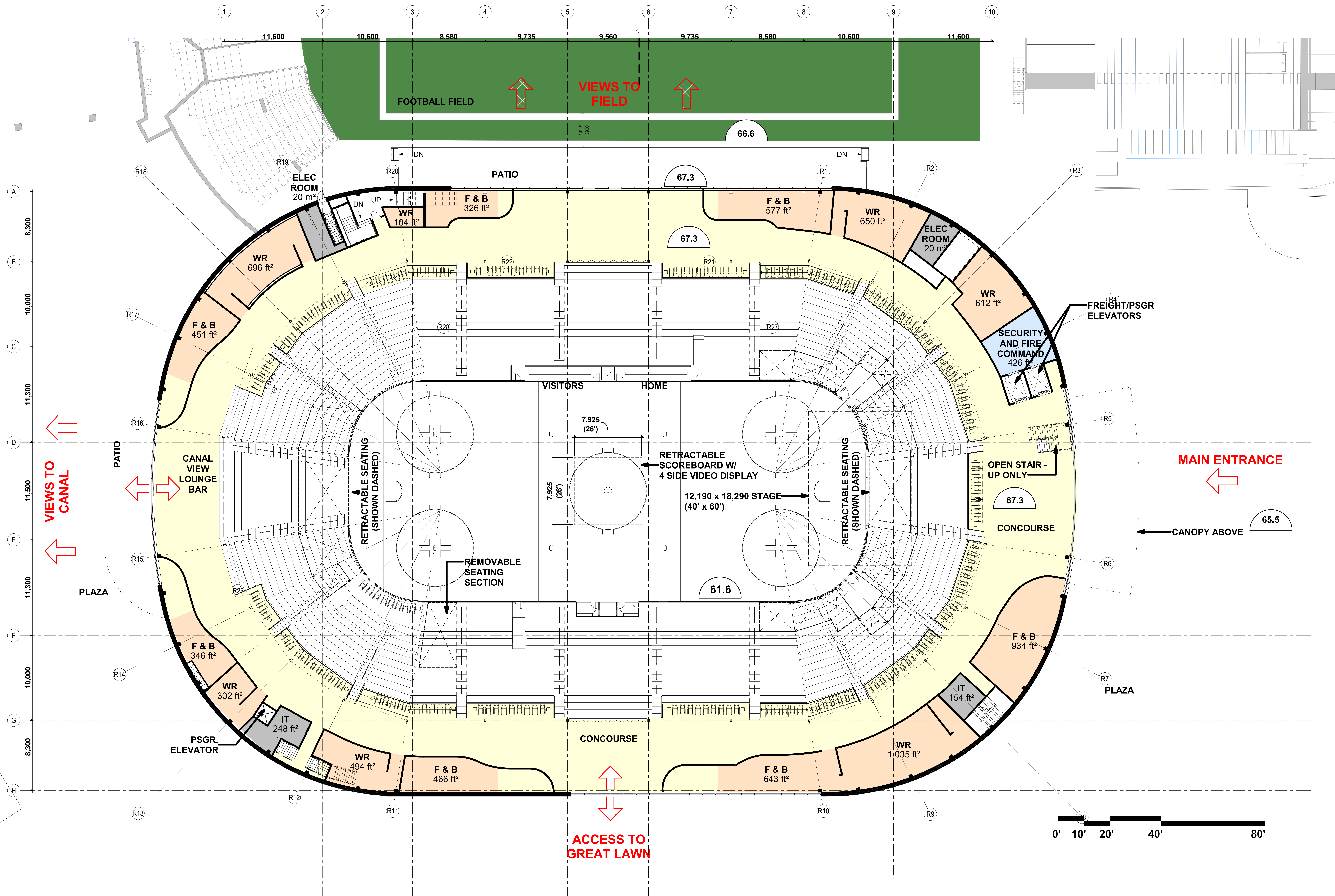

IN PROGRESS

TOTAL EC BLDG AREAS WILL BE REDUCED TO 160,000sf TO MEET BUDGET. NNS AREAS IN EC PROGRAM & ON THESE PLANS ARE APPROVED TO PROCEED IN THIS EC PHASE. DISTRIBUTION OF FUNCTIONAL SPACES ARE FIXED.

DATE: 2024-06-25

2 of 12

LANSDOWNE EVENT CENTRE

L2 OVERALL PLAN

Schematic Design

**BRISBIN
BROOK
BEYNON** ARCHITECTS

DATE PLOTTED: 2024-06-26 1:45:35 PM

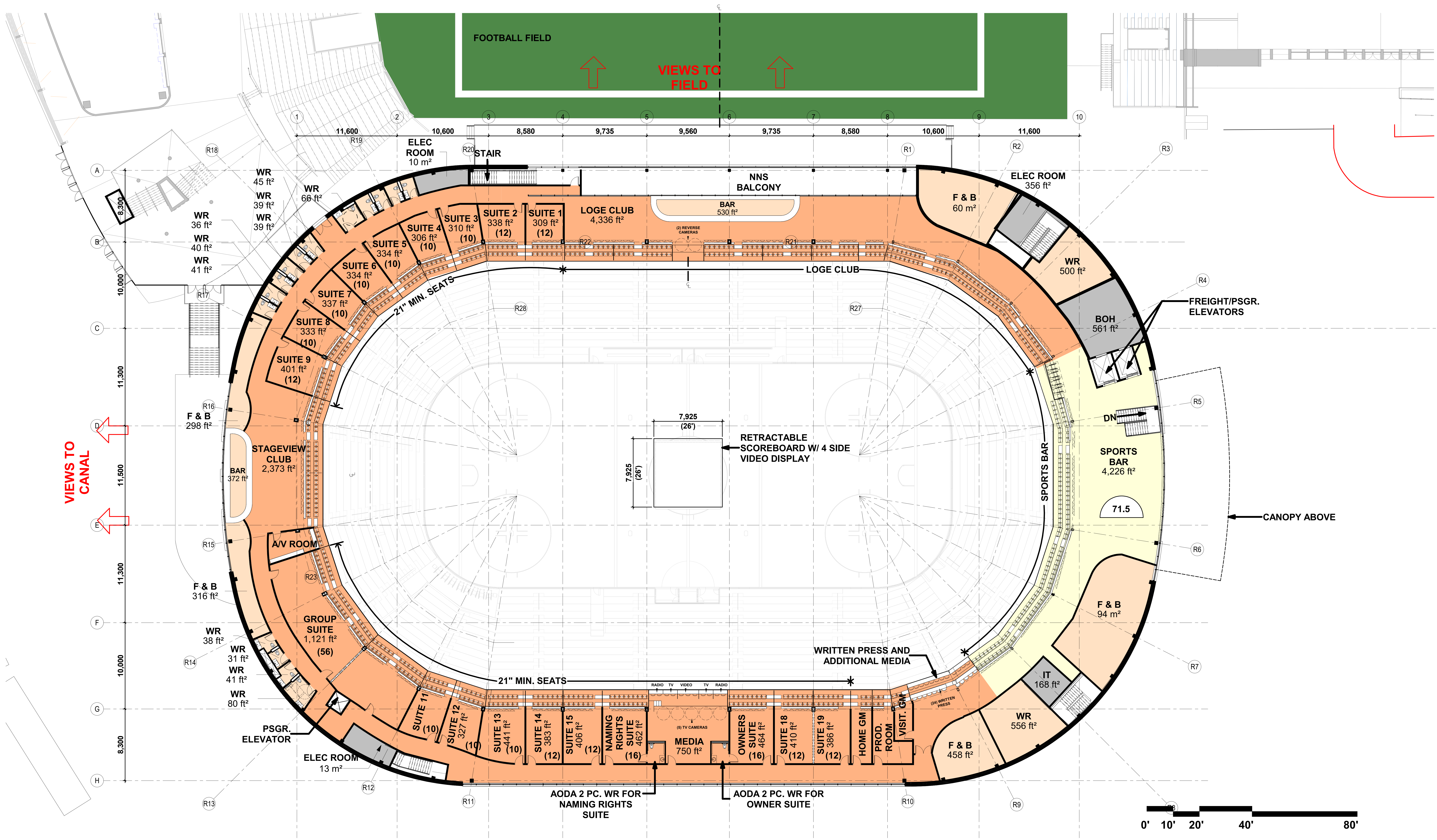

IN PROGRESS

TOTAL EC BLDG AREAS WILL BE REDUCED TO 160,000sf TO MEET BUDGET. NNS AREAS IN EC PROGRAM & ON THESE PLANS ARE APPROVED TO PROCEED IN THIS EC PHASE. DISTRIBUTION OF FUNCTIONAL SPACES ARE FIXED.

DATE: 2024-06-03

3 of 12

LANSDOWNE EVENT CENTRE

L3 OVERALL PLAN

Schematic Design

**BRISBIN
BROOK
BEYNON** ARCHITECTS

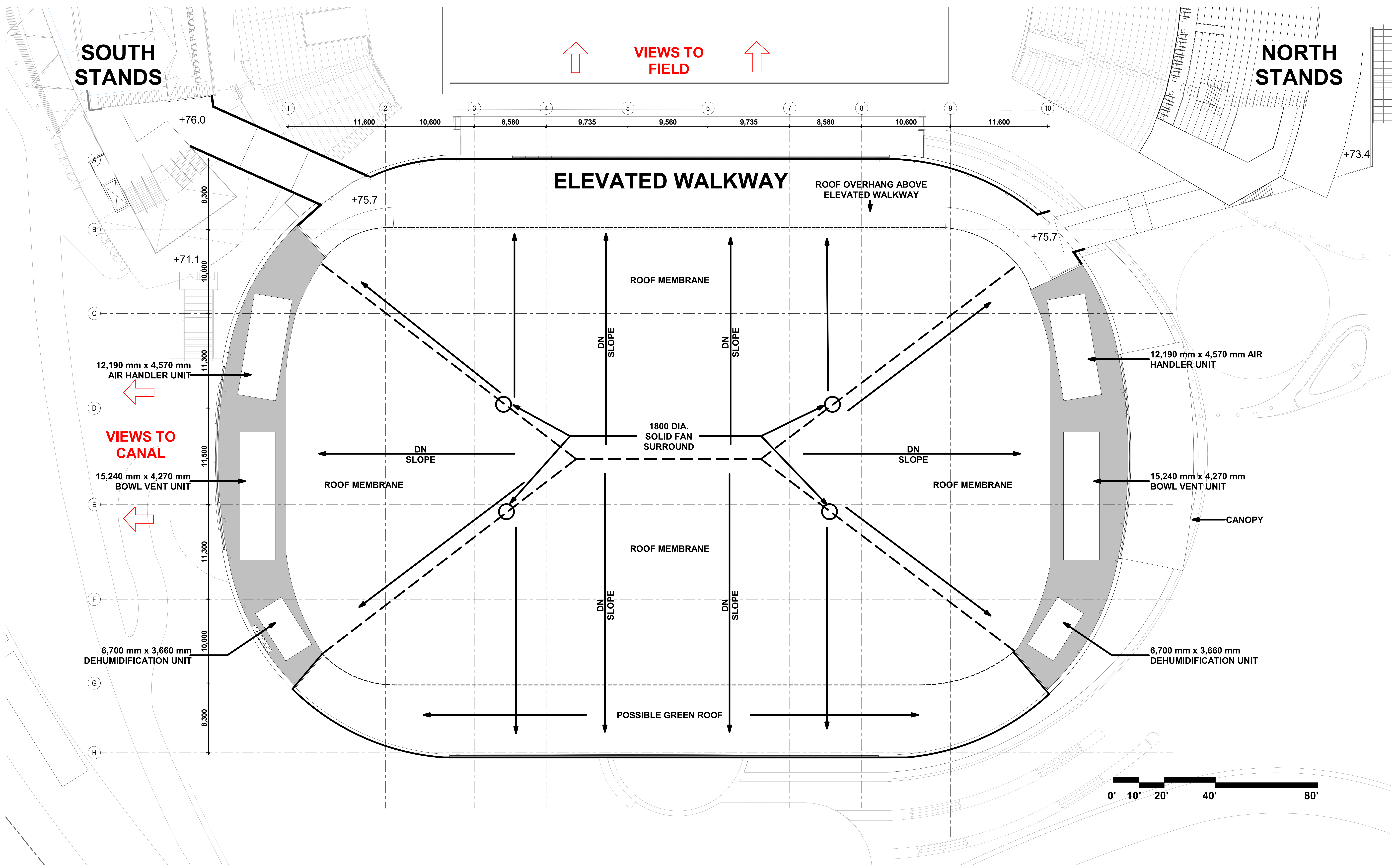

IN PROGRESS

TOTAL EC BLDG AREAS WILL BE REDUCED TO 160,000sf TO MEET BUDGET. NNS AREAS IN EC PROGRAM & ON THESE PLANS ARE APPROVED TO PROCEED IN THIS EC PHASE. DISTRIBUTION OF FUNCTIONAL SPACES ARE FIXED.

DATE: 2024-06-03

4 of 12

LANSDOWNE EVENT CENTRE

ROOF PLAN

Schematic Design

**BRISBIN
BROOK
BEYNON** ARCHITECTS

DATE PLOTTED: 2024-06-26 1:45:48 PM

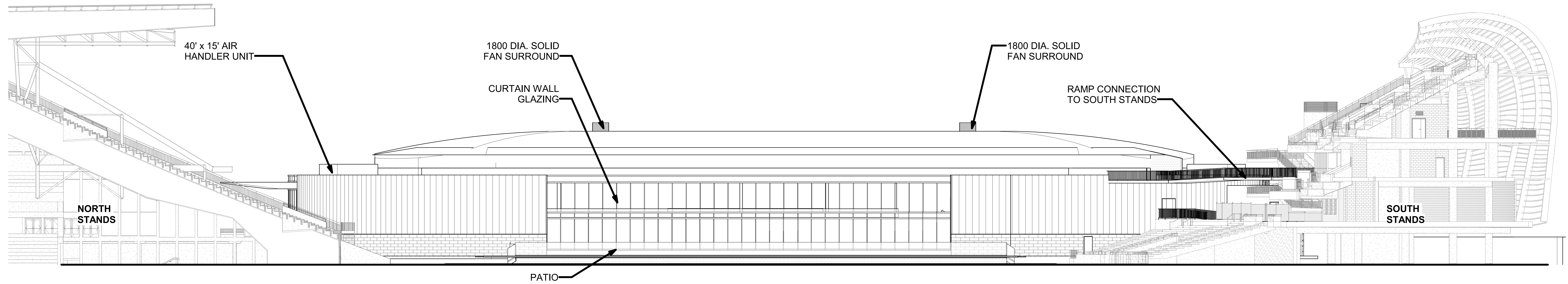

WEST ELEVATION

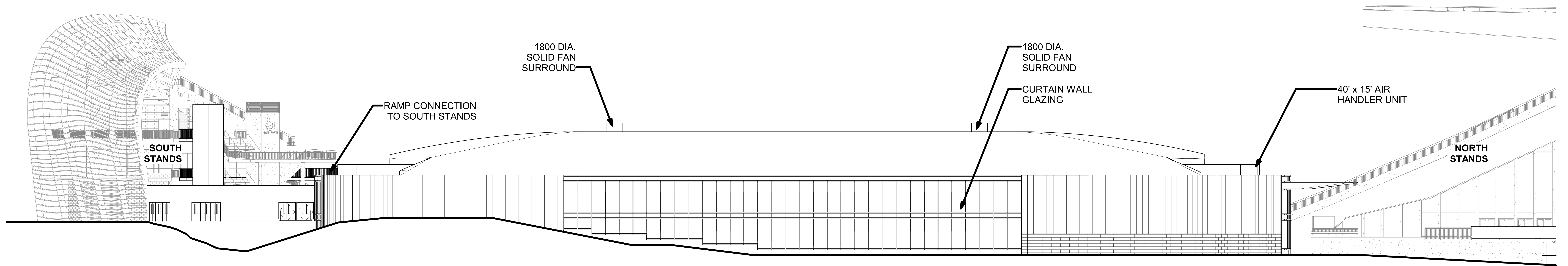

EAST ELEVATION

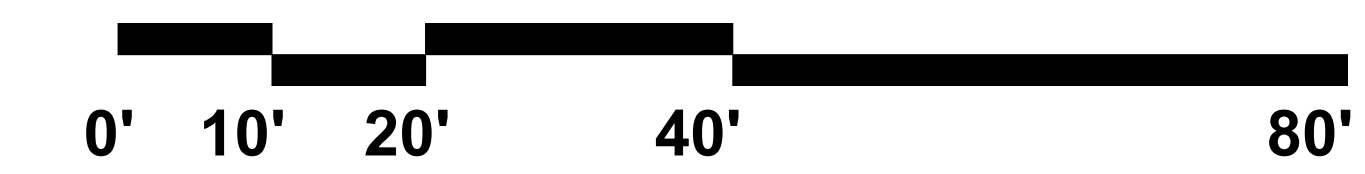

IN PROGRESS

TOTAL EC BLDG AREAS WILL BE REDUCED TO 160,000sf TO MEET BUDGET. NNS AREAS IN EC PROGRAM & ON THESE PLANS ARE APPROVED TO PROCEED IN THIS EC PHASE. DISTRIBUTION OF FUNCTIONAL SPACES ARE FIXED.

DATE: 2024-06-03

9 of 12

**LANSDOWNE EVENT CENTRE
EAST AND WEST ELEVATION**
Schematic Design

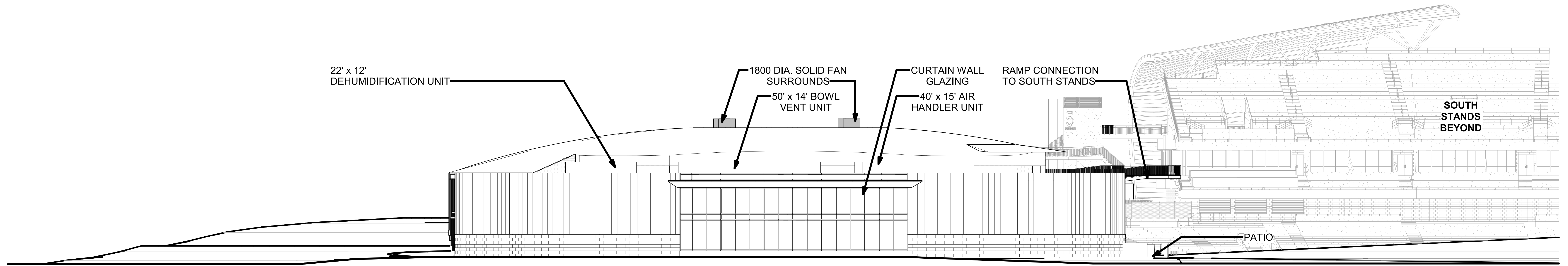

NORTH ELEVATION

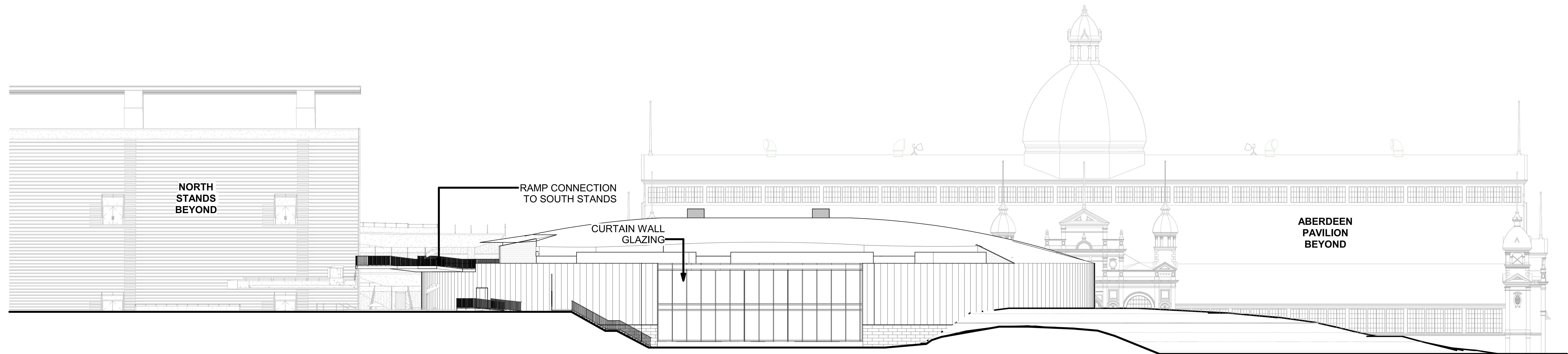

SOUTH ELEVATION

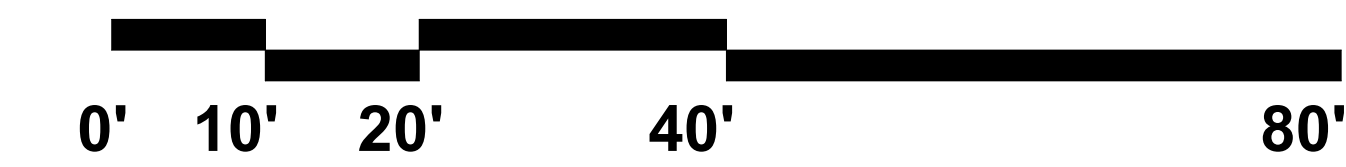

IN PROGRESS

TOTAL EC BLDG AREAS WILL BE REDUCED TO 160,000sf TO MEET BUDGET. NNS AREAS IN EC PROGRAM & ON THESE PLANS ARE APPROVED TO PROCEED IN THIS EC PHASE. DISTRIBUTION OF FUNCTIONAL SPACES ARE FIXED.

DATE: 2024-06-03

10 of 12

**LANSDOWNE EVENT CENTRE
NORTH AND SOUTH ELEVATIONS**
Schematic Design

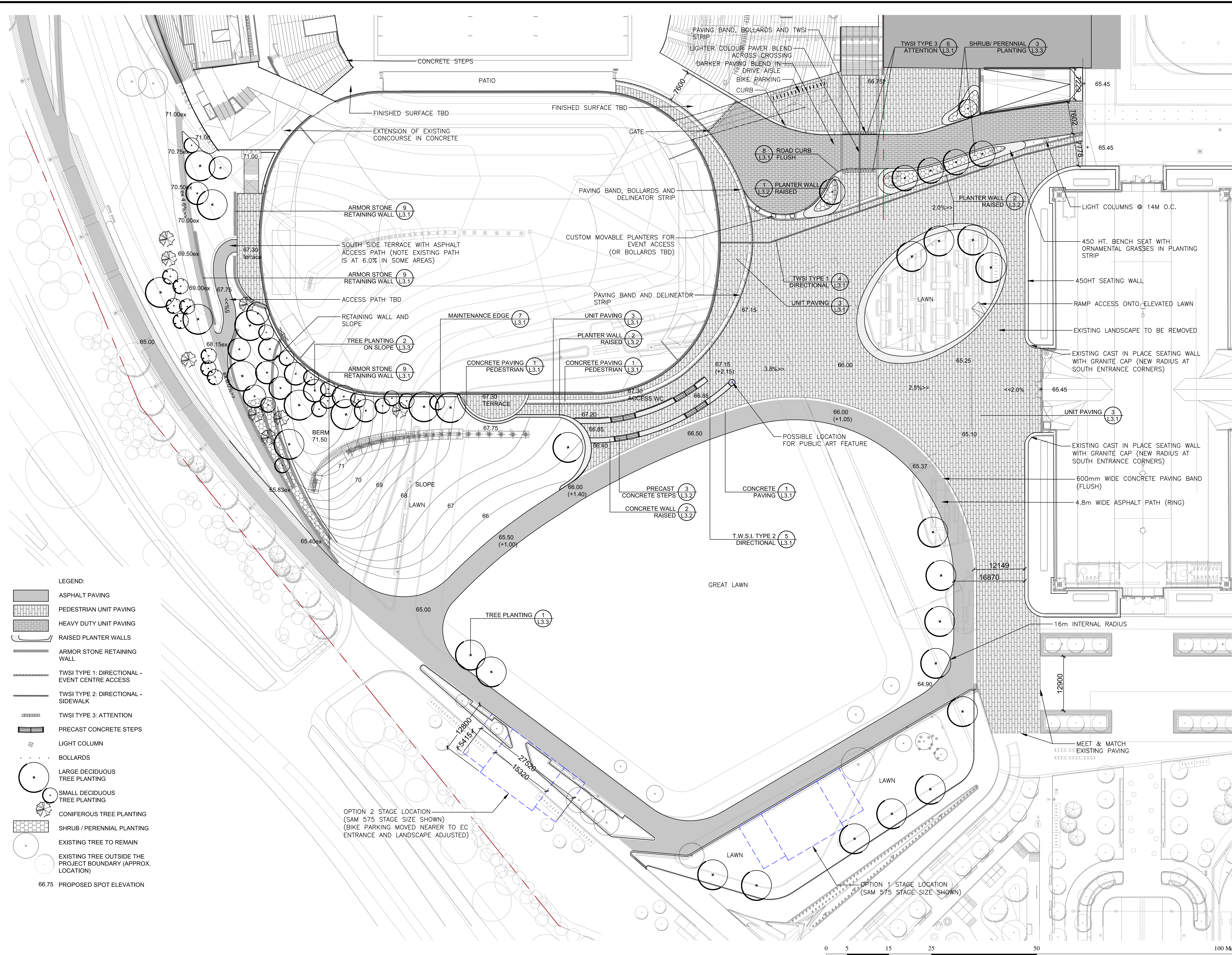

- LEGEND:**
- ASPHALT PAVING
 - PEDESTRIAN UNIT PAVING
 - HEAVY DUTY UNIT PAVING
 - RAISED PLANTER WALLS
 - ARMOR STONE RETAINING WALL
 - TWSI TYPE 1: DIRECTIONAL - EVENT CENTRE ACCESS
 - TWSI TYPE 2: DIRECTIONAL - SIDEWALK
 - TWSI TYPE 3: ATTENTION
 - PRECAST CONCRETE STEPS
 - LIGHT COLUMN
 - BOLLARDS
 - LARGE DECIDUOUS TREE PLANTING
 - SMALL DECIDUOUS TREE PLANTING
 - CONIFEROUS TREE PLANTING
 - SHRUB / PERENNIAL PLANTING
 - EXISTING TREE TO REMAIN
 - EXISTING TREE OUTSIDE THE PROJECT BOUNDARY (APPROX. LOCATION)
- 66.75 PROPOSED SPOT ELEVATION

1	ISSUED FOR PRE-CONSULTATION	31 MAY, 2024
No.	Revision	Date

North:

Stamp:

CSW

Landscape Architecture
Urban Design
Site Planning
Recreation and Park Planning
Project Management

319 McRae Avenue, Suite 502, Ottawa, Ontario, K1Z 0B9
Tel: (613) 729-4536

- All measurements in millimeters unless specified otherwise. Do not scale drawing. All drawings to be read in conjunction with written specifications.
- Copyright reserved. This drawing is the exclusive property of CSW Landscape Architects Ltd. and shall not be used without the consent thereof.
- This Drawing may not be used for construction until signed by the landscape architect. It is the responsibility of the contractor to:
 - check and verify all dimensions on site;
 - report all errors and/or omissions to the landscape architect;
 - comply with all pertinent codes and by-laws;
 - check and verify locations of all underground services with all local utilities prior to any digging.

Project: **LANSDOWNE EVENT CENTRE**

OTTAWA, ONTARIO

Drawing: **LANDSCAPE LAYOUT PLAN**

SHEET 1 OF 6

Scale: 1:400	Date: MAR 2024
Design By: SE	Drawn By: JA
Project Number: 1766-12	Sheet Number: L1.0

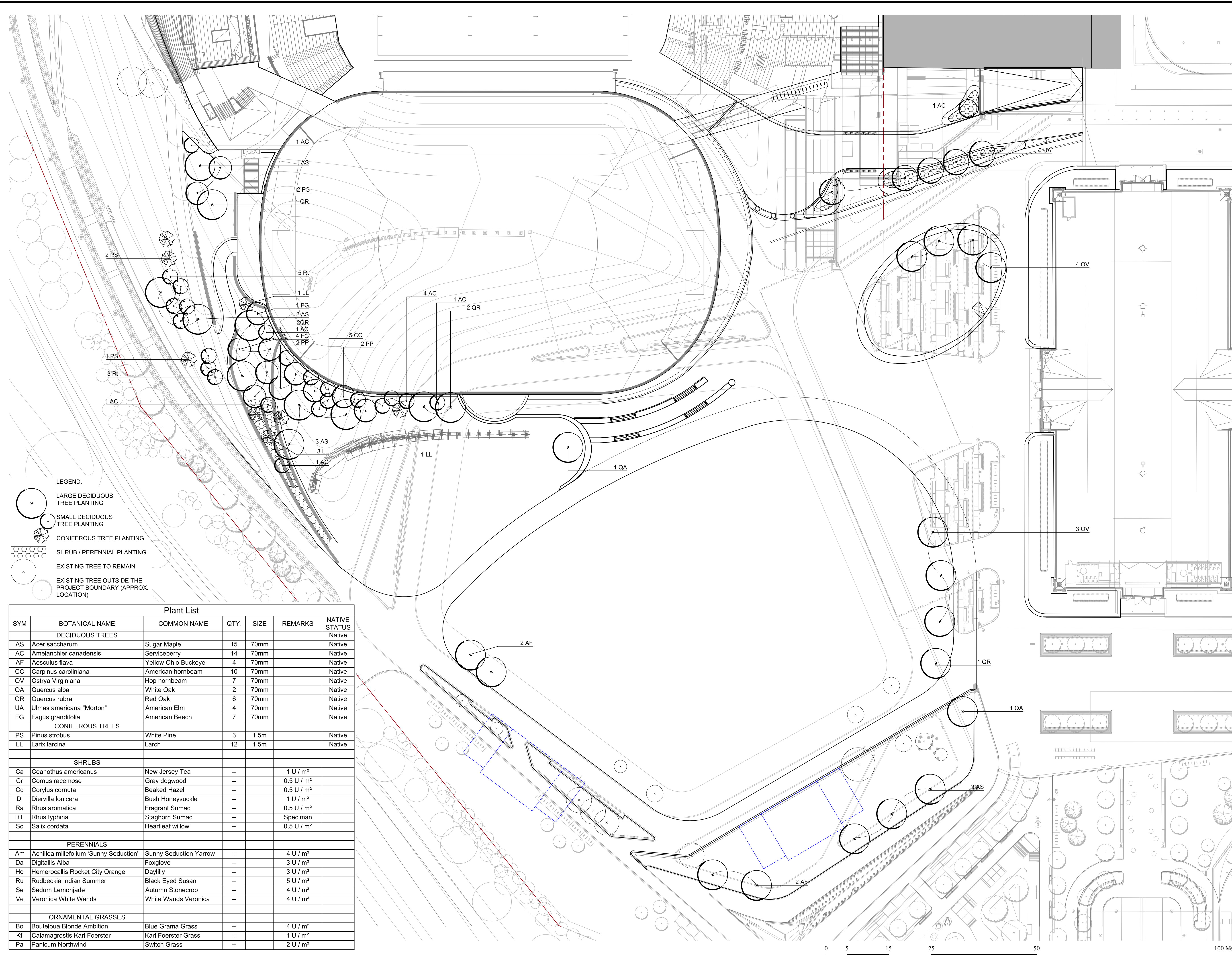

- LEGEND:**
- LARGE DECIDUOUS TREE PLANTING
 - SMALL DECIDUOUS TREE PLANTING
 - CONIFEROUS TREE PLANTING
 - SHRUB / PERENNIAL PLANTING
 - EXISTING TREE TO REMAIN
 - EXISTING TREE OUTSIDE THE PROJECT BOUNDARY (APPROX. LOCATION)

Plant List						
SYM	BOTANICAL NAME	COMMON NAME	QTY.	SIZE	REMARKS	NATIVE STATUS
DECIDUOUS TREES						
AS	Acer saccharum	Sugar Maple	15	70mm		Native
AC	Amelanchier canadensis	Serviceberry	14	70mm		Native
AF	Aesculus flava	Yellow Ohio Buckeye	4	70mm		Native
CC	Carpinus caroliniana	American hornbeam	10	70mm		Native
OV	Ostrya Virginiana	Hop hornbeam	7	70mm		Native
QA	Quercus alba	White Oak	2	70mm		Native
QR	Quercus rubra	Red Oak	6	70mm		Native
UA	Ulmus americana "Morton"	American Elm	4	70mm		Native
FG	Fagus grandifolia	American Beech	7	70mm		Native
CONIFEROUS TREES						
PS	Pinus strobus	White Pine	3	1.5m		Native
LL	Larix laricina	Larch	12	1.5m		Native
SHRUBS						
Ca	Ceanothus americanus	New Jersey Tea	--		1 U / m ²	
Cr	Cornus racemosa	Gray dogwood	--		0.5 U / m ²	
Cc	Corylus cornuta	Beaked Hazel	--		0.5 U / m ²	
Di	Diervilla lonicera	Bush Honeysuckle	--		1 U / m ²	
Ra	Rhus aromatica	Fragrant Sumac	--		0.5 U / m ²	
RT	Rhus typhina	Staghorn Sumac	--		Speciman	
Sc	Salix cordata	Heartleaf willow	--		0.5 U / m ²	
PERENNIALS						
Am	Achillea millefolium 'Sunny Seduction'	Sunny Seduction Yarrow	--		4 U / m ²	
Da	Digitalis Alba	Foxglove	--		3 U / m ²	
He	Hemerocallis Rocket City Orange	Daylily	--		3 U / m ²	
Ru	Rudbeckia Indian Summer	Black Eyed Susan	--		5 U / m ²	
Se	Sedum Lemonjade	Autumn Stonecrop	--		4 U / m ²	
Ve	Veronica White Wands	White Wands Veronica	--		4 U / m ²	
ORNAMENTAL GRASSES						
Bo	Bouteloua Blonde Ambition	Blue Grama Grass	--		4 U / m ²	
Kf	Calamagrostis Karl Foerster	Karl Foerster Grass	--		1 U / m ²	
Pa	Panicum Northwind	Switch Grass	--		2 U / m ²	

1	ISSUED FOR PRE-CONSULTATION	31 MAY, 2024
No.	Revision	Date

North:

Stamp:

Landscape Architecture
Urban Design
Site Planning
Recreation and Park Planning
Project Management

319 McRae Avenue, Suite 502, Ottawa, Ontario, K1Z 0B9
Tel: (613) 729-4536

- All measurements in millimeters unless specified otherwise. Do not scale drawing. All drawings to be read in conjunction with written specifications.
- Copyright reserved. This drawing is the exclusive property of CSW Landscape Architects Ltd. and shall not be used without the consent thereof.
- This Drawing may not be used for construction until signed by the landscape architect. It is the responsibility of the contractor to:
 - check and verify all dimensions on site;
 - report all errors and/or omissions to the landscape architect;
 - comply with all pertinent codes and by-laws;
 - check and verify locations of all underground services with all local utilities prior to any digging.

Project: **LANSDOWNE EVENT CENTRE**

OTTAWA, ONTARIO

Drawing: **PLANTING PLAN**

SHEET 2 OF 6

Scale: 1:400	Date: MAR 2024
Design By: SE/CM	Drawn By: SC
Project Number: 1766-12	Sheet Number: L2.0

- NOTES:
- FINISHES AS SPECIFIED: REFER TO PATTERNING PLAN.
 - REFER TO DETAIL 2/L3.1 FOR JOINTING INFORMATION
 - WELDED WIRE MESH - 50mm FROM BOTTOM OF PROFILE
 - REINFORCING BARS - CENTRED IN PROFILE.

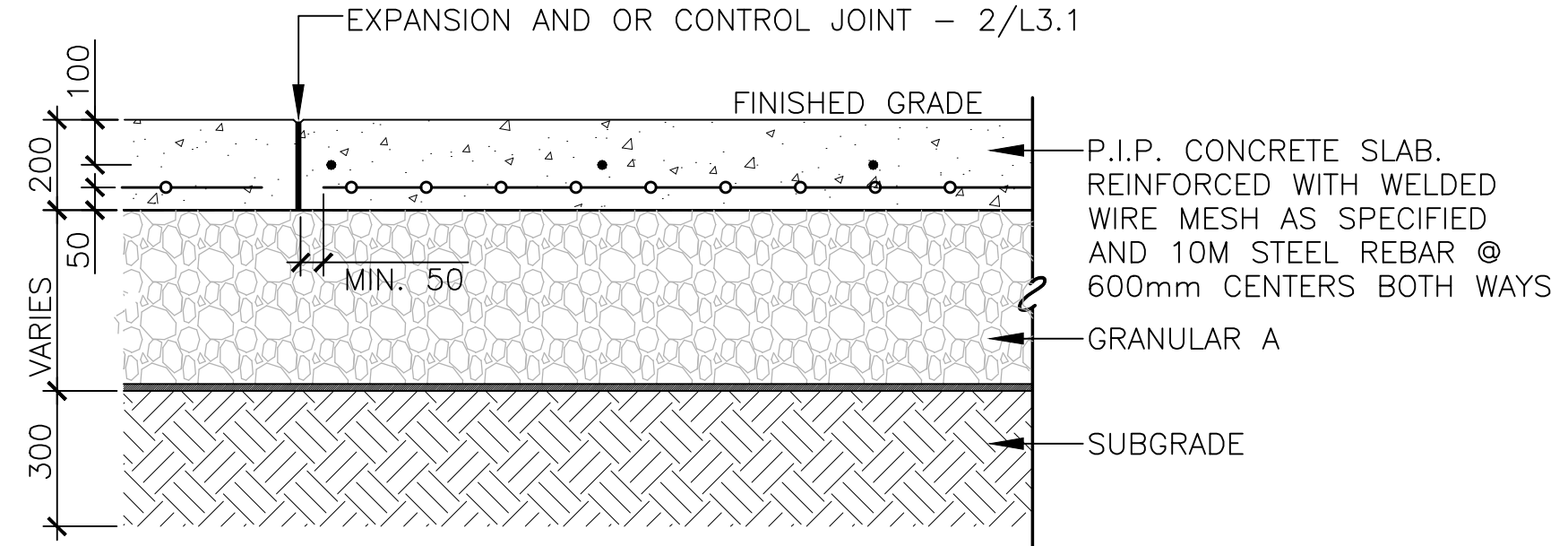

1 CONCRETE SURFACE - REINFORCED
3.1 SCALE - 1:15

- NOTES:
- INSTALL T.W.S.I. TILE FLUSH WITH FINISHED CONCRETE SURFACE AS PER MANUFACTURER'S INSTRUCTIONS.
 - REFER TO PATTERNING ENLARGEMENT DRAWINGS FOR PLACEMENT AND SPACING - REFER TO ENLARGEMENT
 - INSTALL GRANITE TILES IN CONTINUOUS STRAIGHT AND TRUE LINE. JOINTING BETWEEN TILES TO BE PERFORMED AS PER MANUFACTURER'S RECOMMENDATIONS.

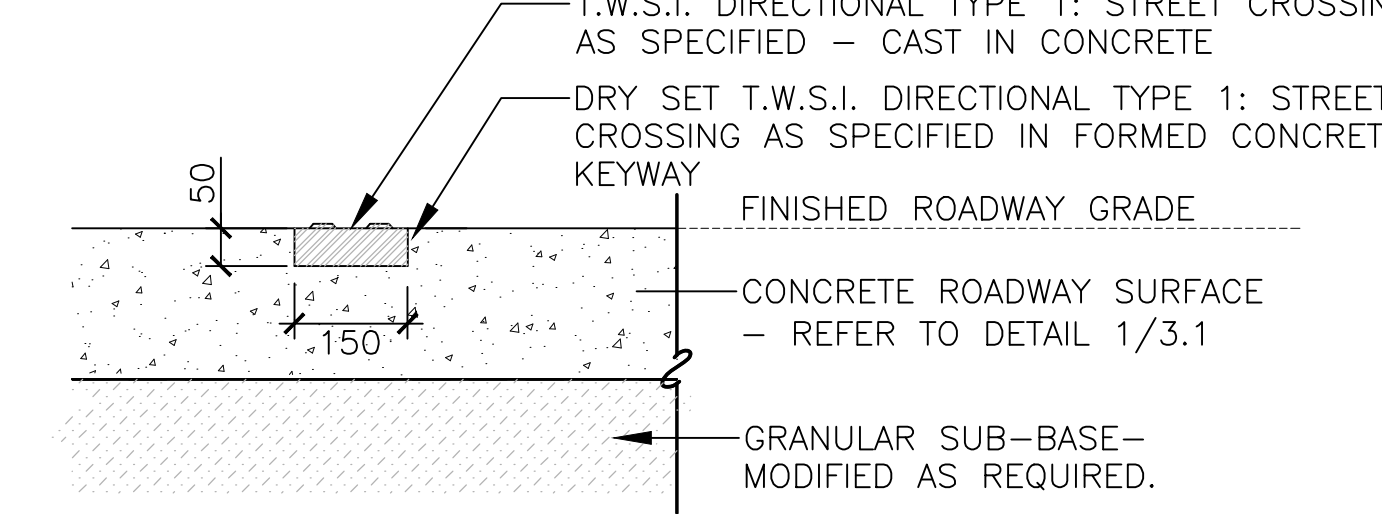

4 TWSI TYPE 1: DIRECTIONAL - EVENT CENTRE ACCESS
3.1 SCALE - 1:10

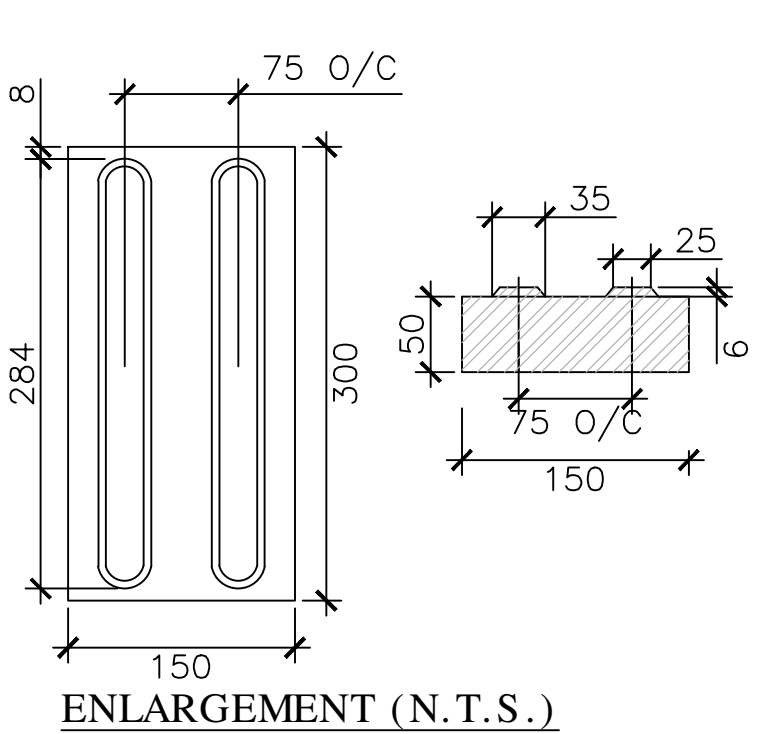

ENLARGEMENT (N.T.S.)

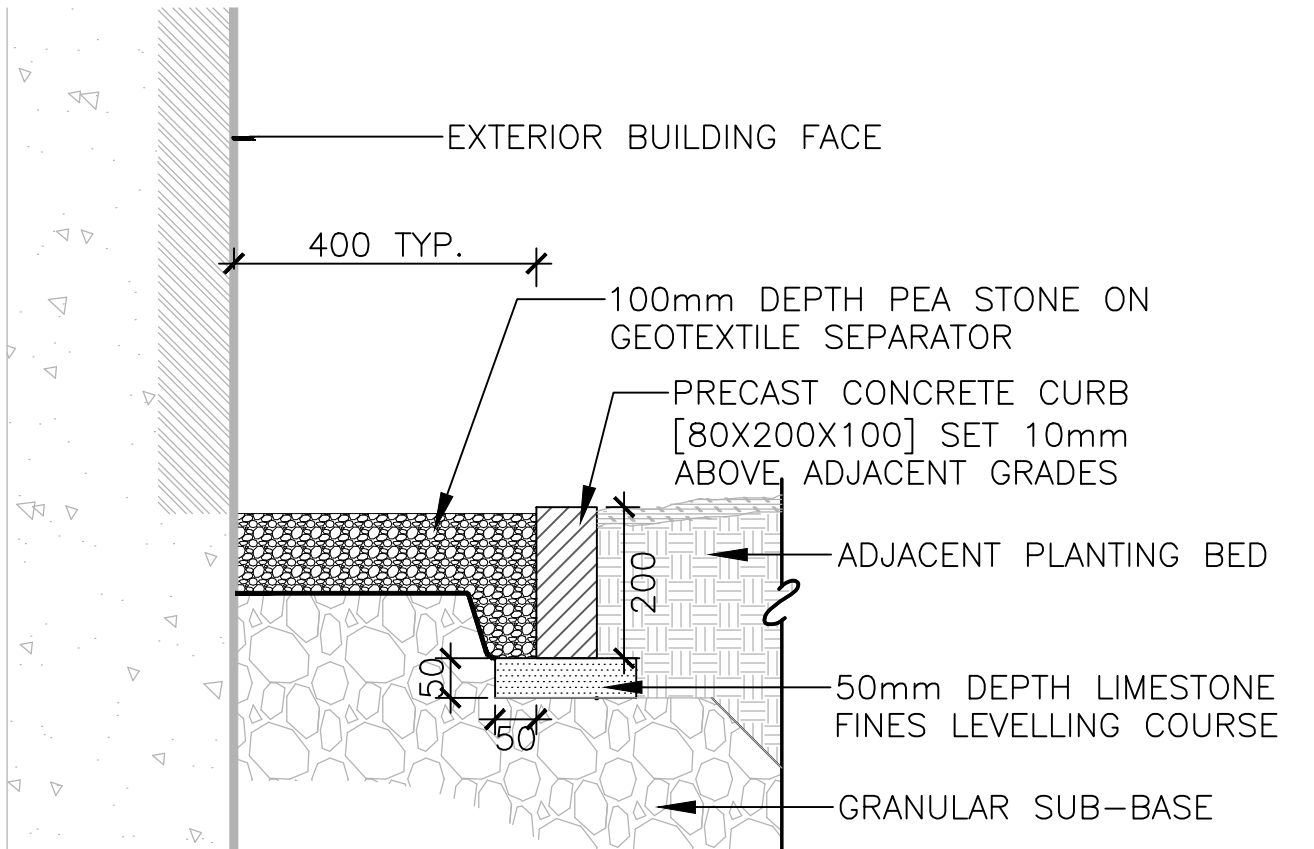

7 MAINTENANCE EDGE
3.1 SCALE - 1:10

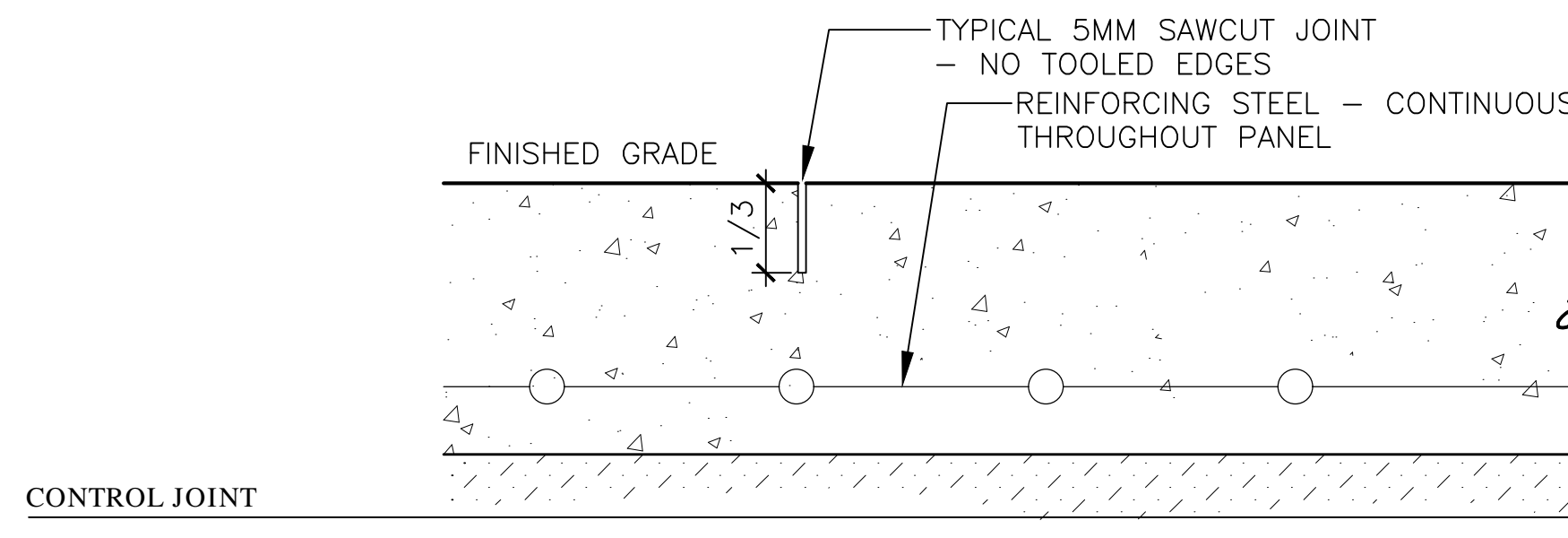

3.1 CONTROL JOINT

- NOTES:
- INSTALL T.W.S.I. TILE FLUSH WITH FINISHED CONCRETE SURFACE AS PER MANUFACTURER'S INSTRUCTIONS.
 - REFER TO PATTERNING ENLARGEMENT DRAWINGS FOR PLACEMENT AND SPACING - L1.0
 - INSTALL TILES IN CONTINUOUS STRAIGHT AND TRUE LINE. JOINTING BETWEEN TILES TO BE PERFORMED AS PER MANUFACTURER'S RECOMMENDATIONS.

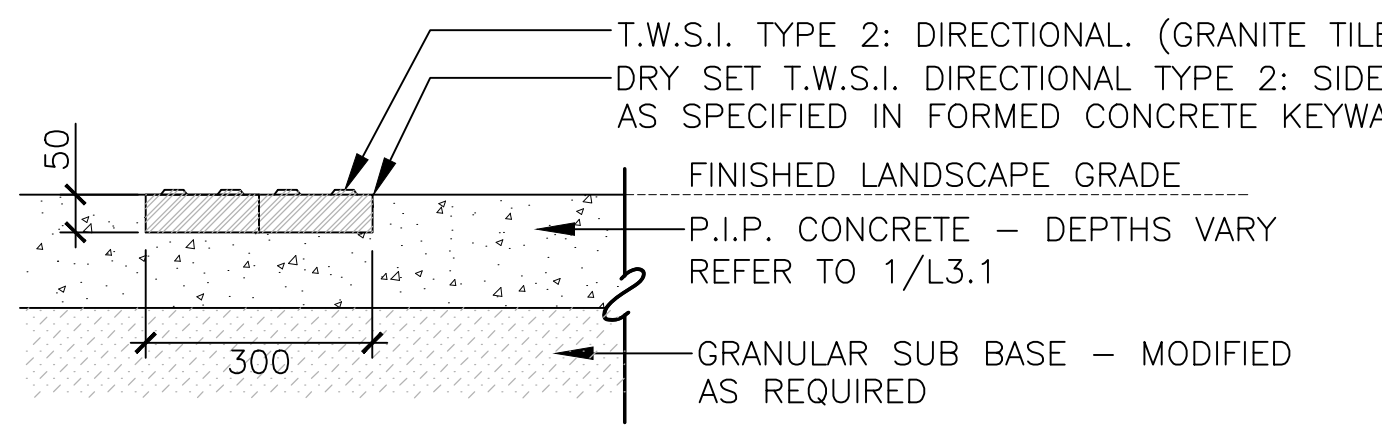

5 TWSI TYPE 2 DIRECTIONAL - SIDEWALK
3.1 SCALE - 1:10

- NOTES:
- PROVIDE DOWELED BIT. FIBRE EXPANSION JOINT BETWEEN CURB AND ALL ADJACENT CONCRETE SURFACES.
 - SAW CUT CONTROL JOINTS FULL WIDTH OF CURB AT EVERY 3m O.C.
 - TOP OF CURB TO BE FLUSH WITH ADJACENT PAVEMENTS BOTH SIDES.
 - REINFORCE CURB WITH CONTINUOUS EPOXY COATED 10M STEEL BARS

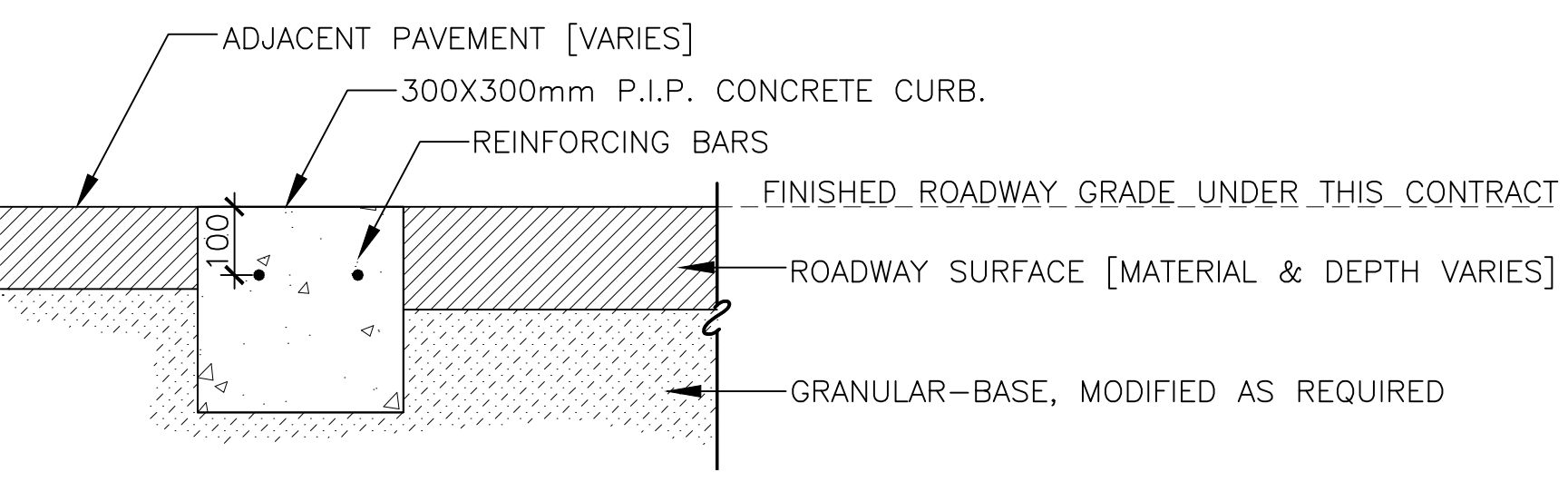

8 ROAD CURB- FLUSH
3.1 SCALE - 1:10

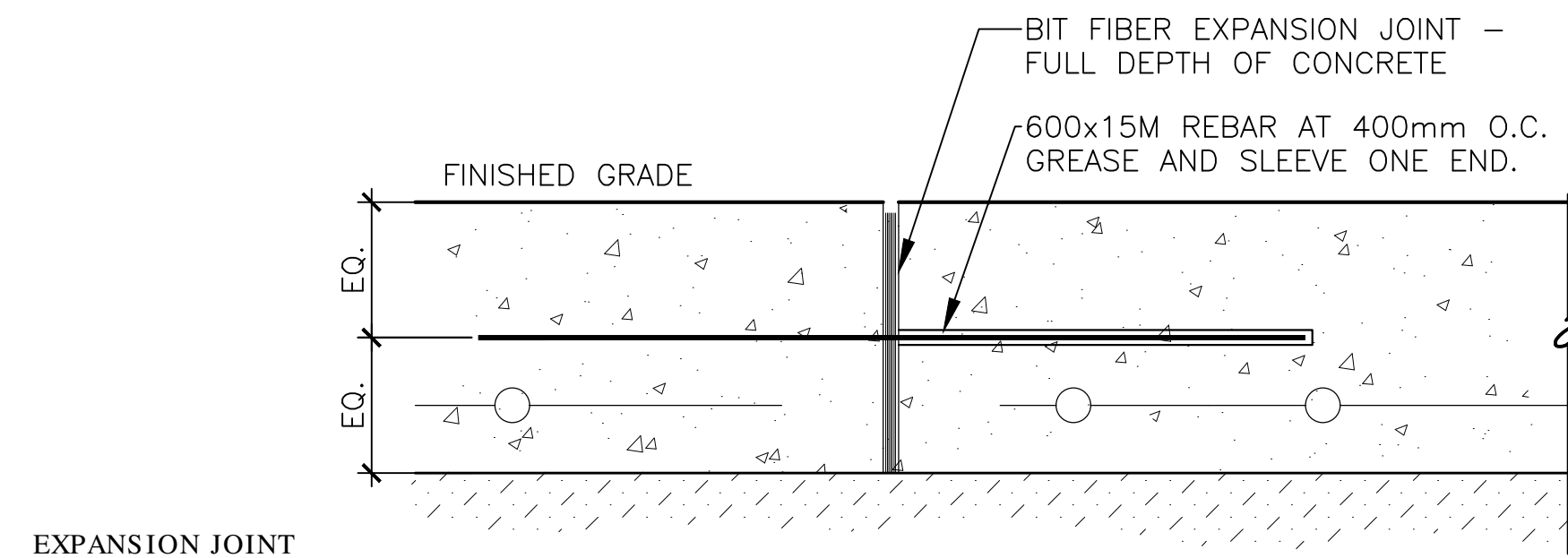

2 TYPICAL CONCRETE JOINTS - 150mm
3.1 SCALE - 1:5

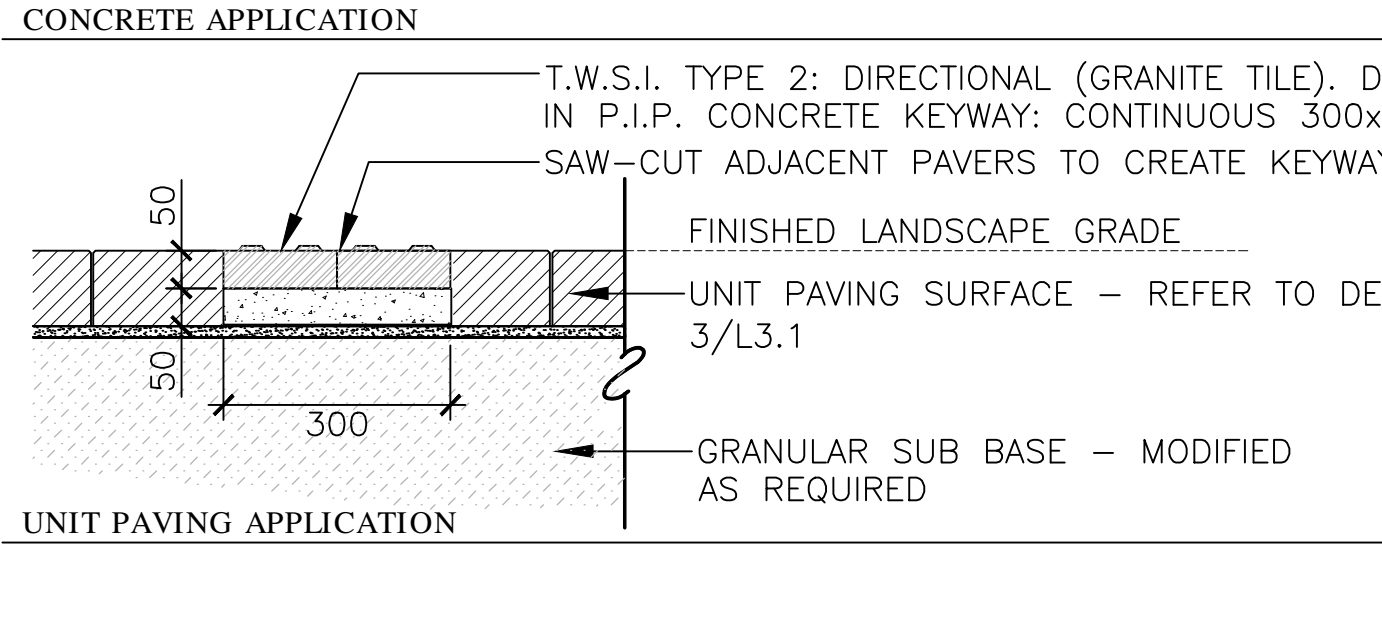

5 TWSI TYPE 2 DIRECTIONAL - SIDEWALK
3.1 SCALE - 1:10

3.1 EXPANSION JOINT

- NOTES:
- TYPICAL PROFILE APPLIES TO ALL UNIT PAVING TYPES.
 - PATTERNS AND LAYOUT VARY BY PAVER TYPE - REFER TO LAYOUT/PATTERNING PLANS.

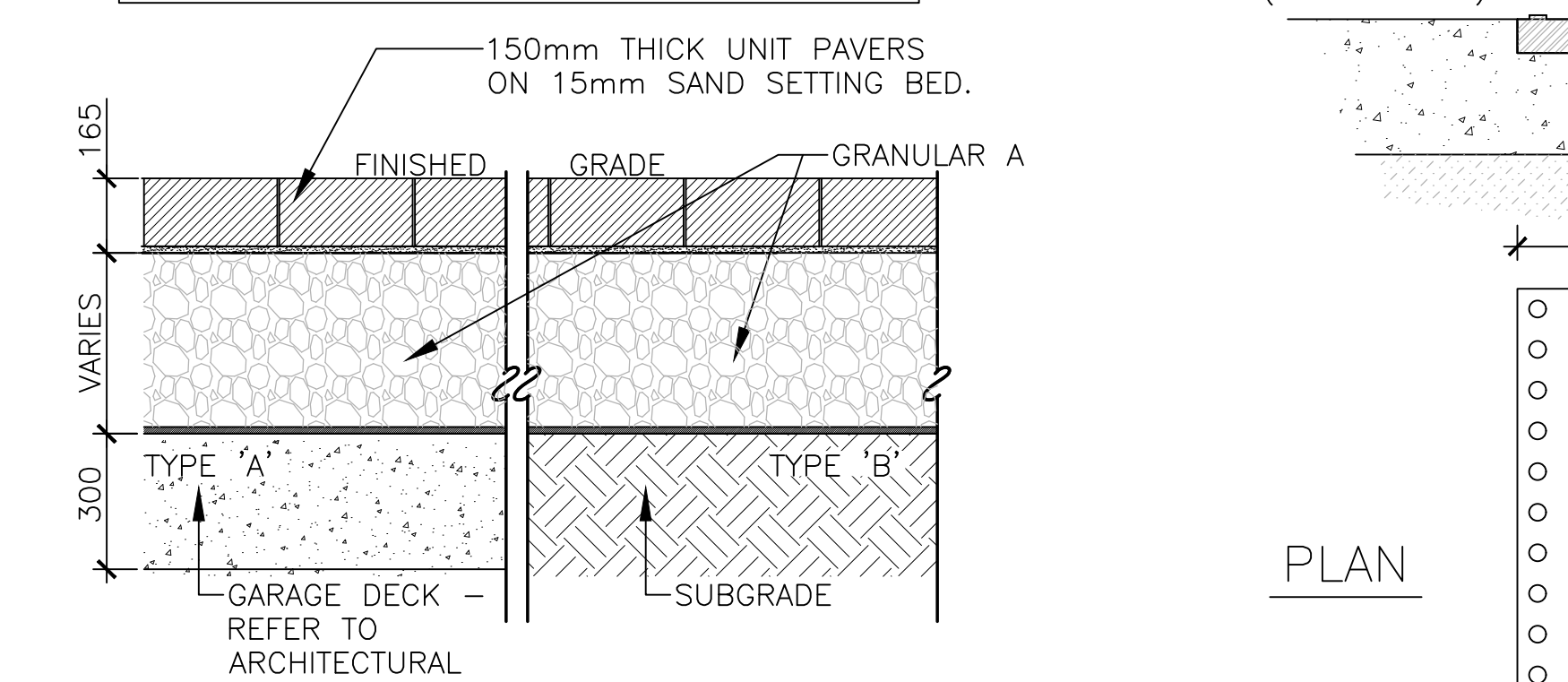

3 UNIT PAVING - TYPICAL PROFILE
3.1 SCALE - 1:15

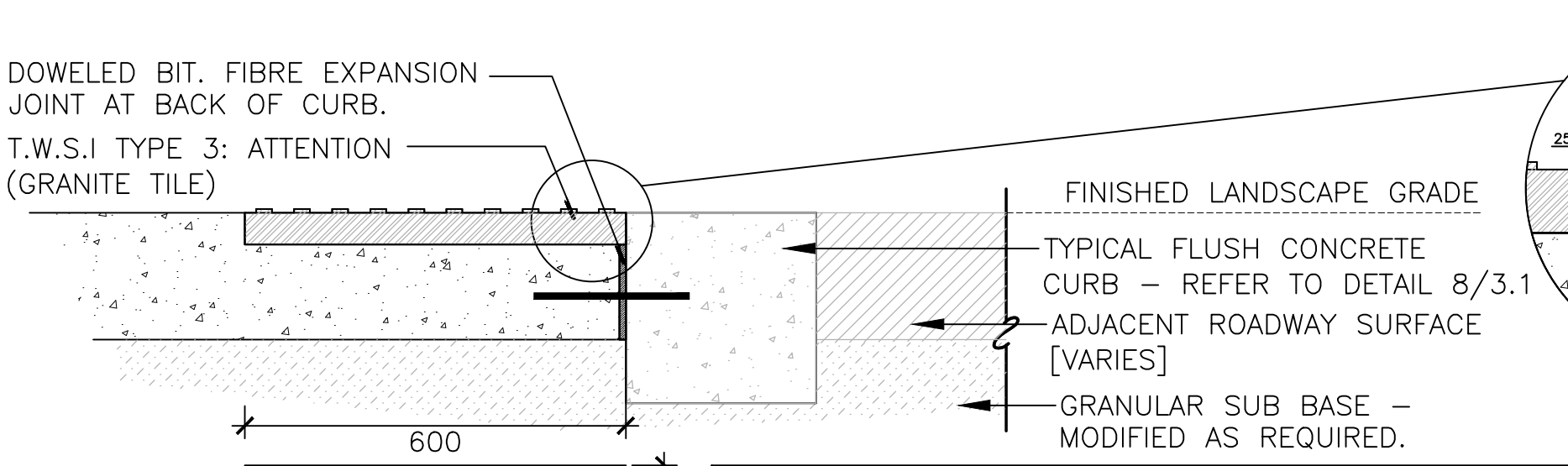

6 TWSI TYPE 3: ATTENTION
3.1 SCALE - 1:10

- NOTES:
- INSTALL T.W.S.I. ATTENTION TILE FLUSH WITH FINISHED CONCRETE SURFACE AS PER MANUFACTURER'S INSTRUCTIONS.
 - REFER TO L1.0 FOR LAYOUT
 - CONTRACTOR TO SUPPLY CURVED TILE UNITS TO MATCH ROADWAY RADIUS' AS NOTED ON LAYOUT PLANS. CUTTING OF TILES ON SITE WILL NOT BE ACCEPTED.

3.1 PLAN

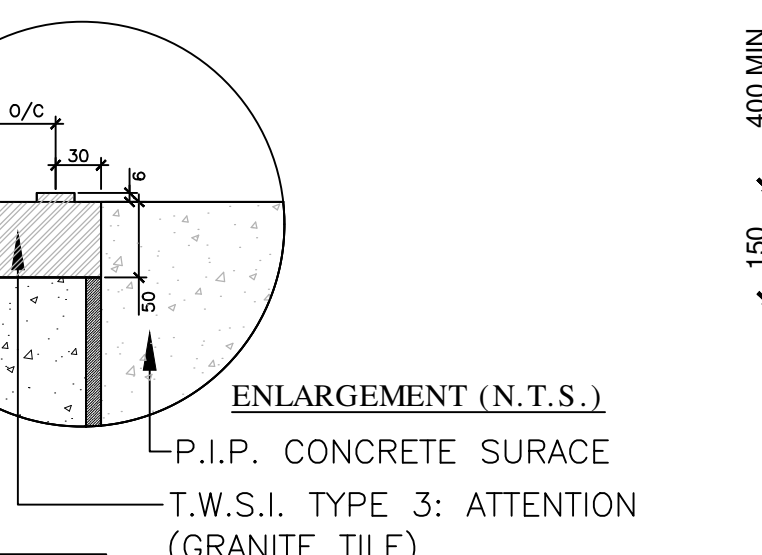

ENLARGEMENT (N.T.S.)

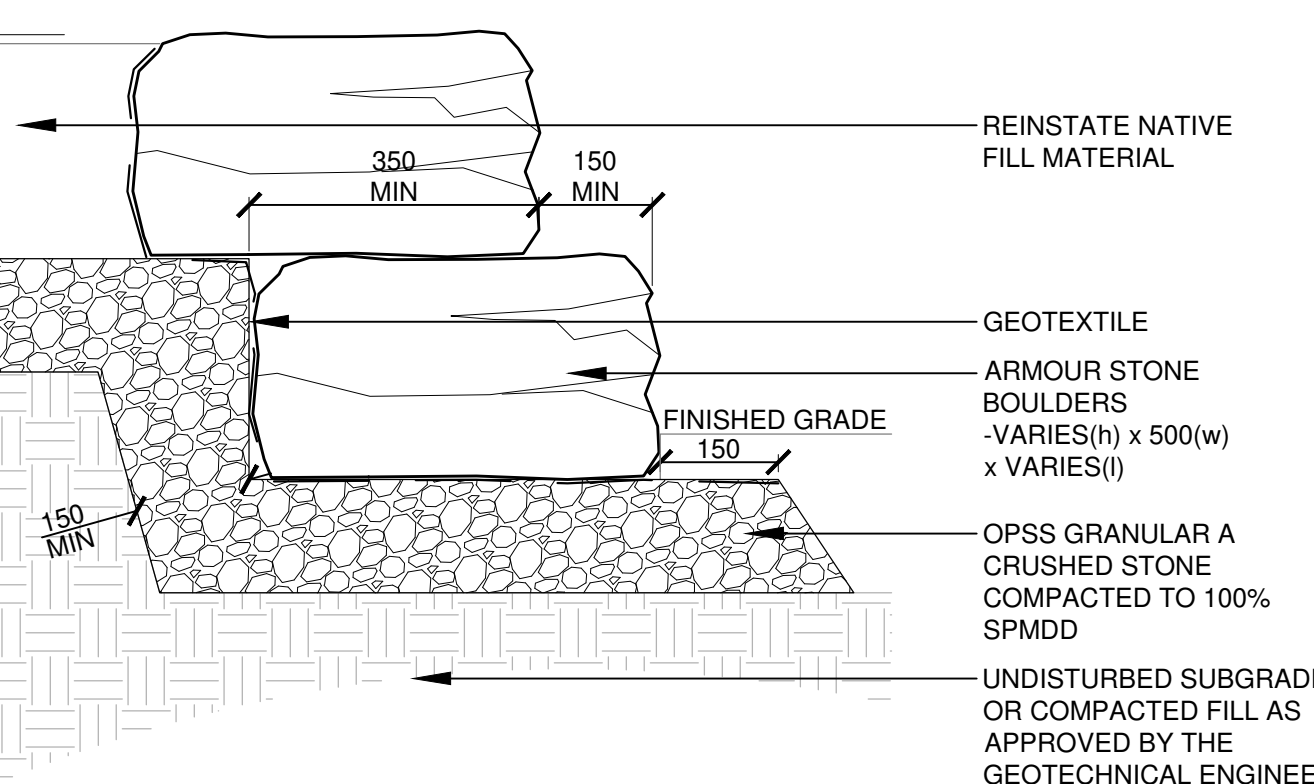

9 ARMOR STONE RETAINING WALL
3.1 SCALE - 1:10

- NOTES:
- ARMOUR STONE WALL TO STEP AS REQUIRED. REFER TO GRADING PLAN FOR ELEVATIONS
 - DO NOT SLOPE TOP OF WALL
 - ENSURE ALL EXPOSED EDGES ARE BLUNTED/EASED TO 6mm MINIMUM
 - MAXIMUM GAP BETWEEN BOULDERS IS 50mm
 - FILL GAPS WITH GEOTEXTILE AND COMPACTED GRANULAR AS REQUIRED
 - MAXIMUM EXPOSED FACE/STEP IS 550mm (TYPICAL)
 - EXCAVATION AND SUBGRADE CONDITION TO BE REVIEWED BY GEOTECHNICAL ENGINEER
 - FOR WALLS OVER 1000 MM - REFER TO STRUCTURAL/GEOTECH (STAMP DRAWING)

1	ISSUED FOR PRE-CONSULTATION	31 MAY, 2024
No.	Revision	Date

North:

Stamp:

CSW

Landscape Architecture
Urban Design
Site Planning
Recreation and Park Planning
Project Management

319 McRae Avenue, Suite 502, Ottawa, Ontario, K1Z 0B9
Tel: (613) 729-4536

- All measurements in millimeters unless specified otherwise. Do not scale drawing. All drawings to be read in conjunction with written specifications.
- Copyright reserved. This drawing is the exclusive property of CSW Landscape Architects Ltd. and shall not be used without the consent thereof.
- This Drawing may not be used for construction until signed by the landscape architect. It is the responsibility of the contractor to:
 - check and verify all dimensions on site;
 - report all errors and/or omissions to the landscape architect;
 - comply with all pertinent codes and by-laws;
 - check and verify locations of all underground services with all local utilities prior to any digging.

Project:

LANSDOWNE EVENT CENTRE

OTTAWA, ONTARIO

Drawing:

LANDSCAPE DETAILS PROPOSED DEVELOPMENT

SHEET 3 OF 6

Scale:	Date:
AS SHOWN	MAY 2024
Design By:	Drawn By:
SE	SE
Project Number:	Sheet Number:
1766-12	L 3.1

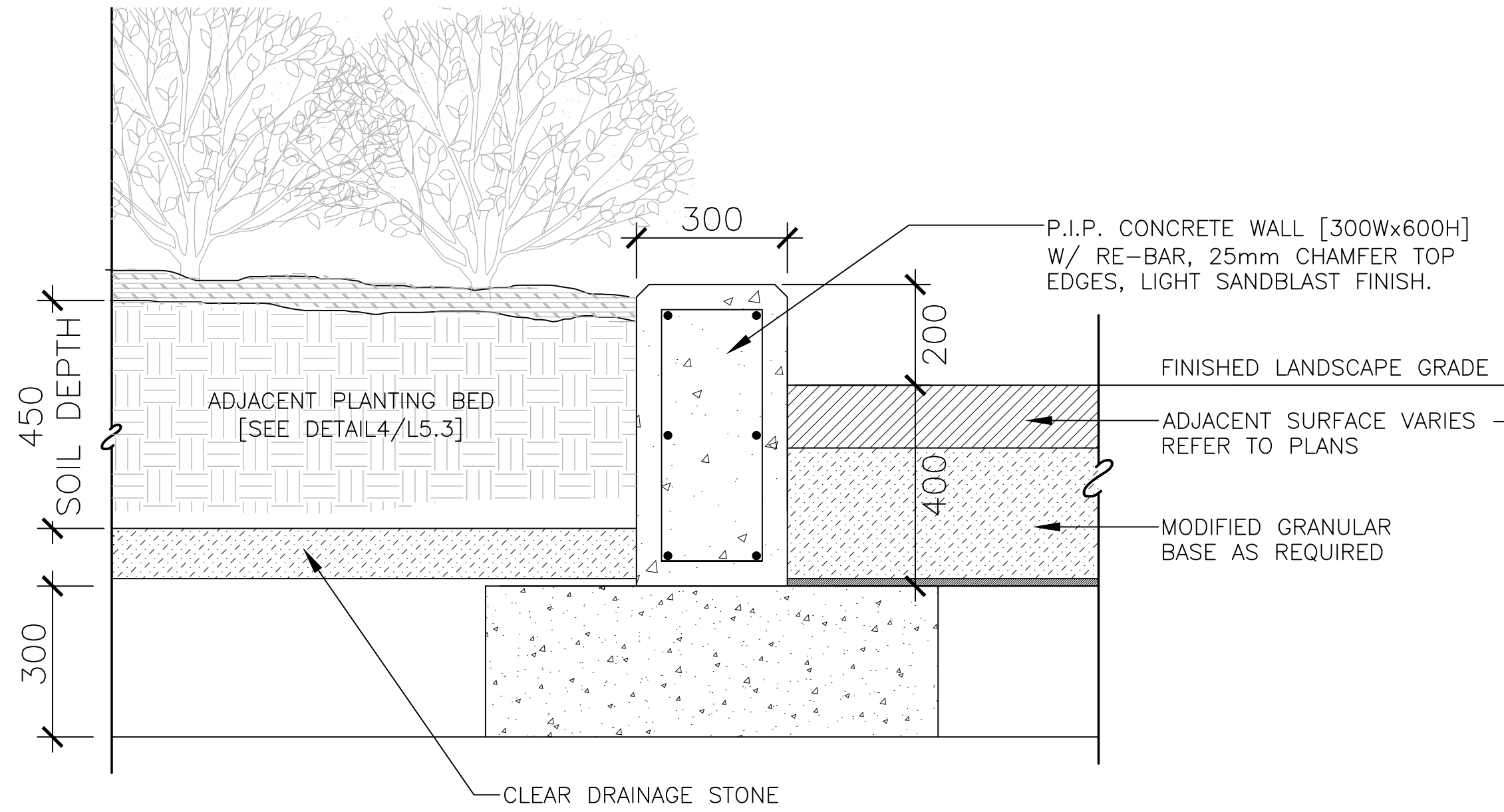

1
3.2 PLANTER CURB - ROAD SIDE

SCALE - 1:10

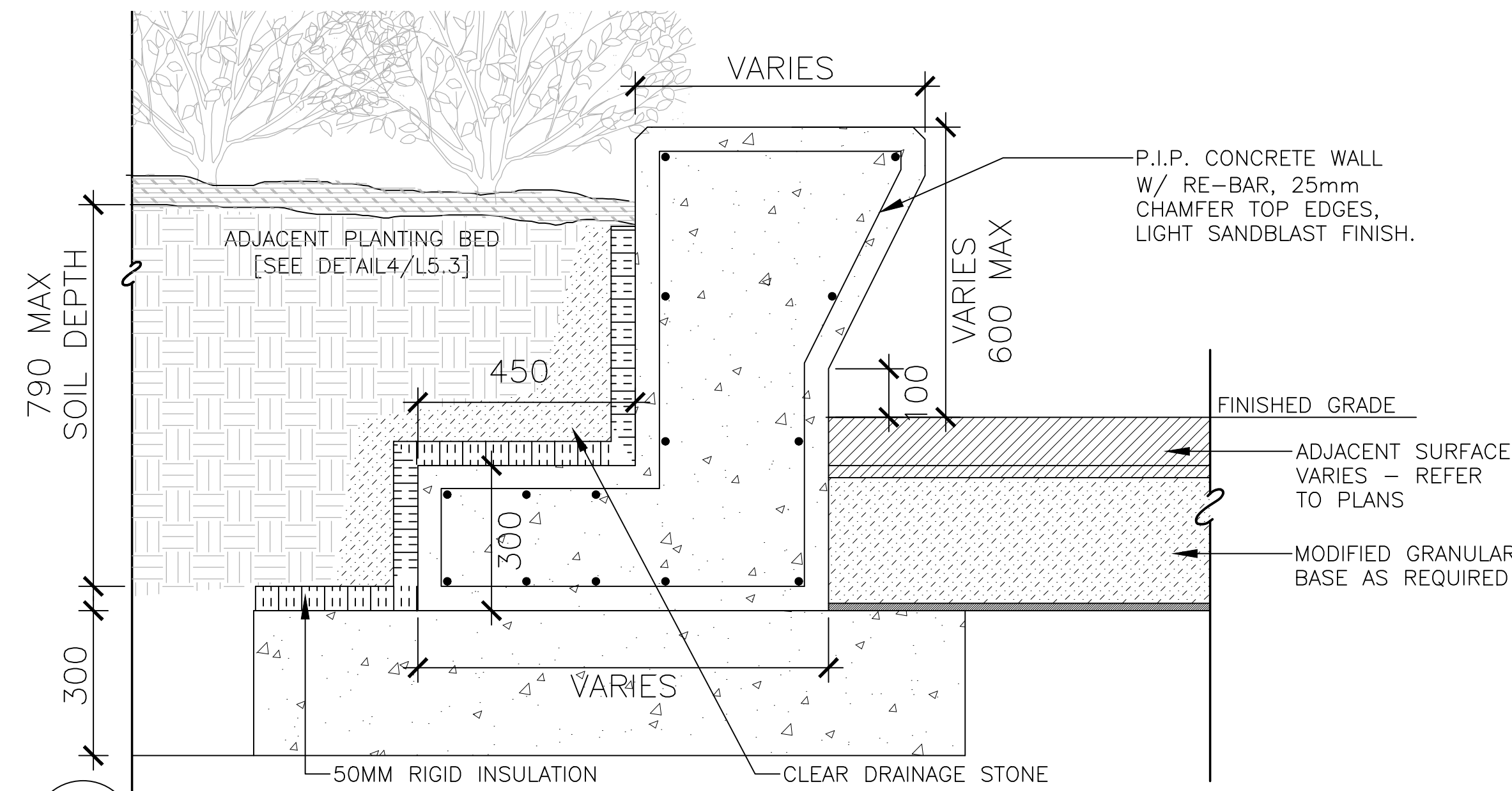

2
3.2 RAISED PLANTER WALL - RAISED PODIUM

SCALE - 1:10

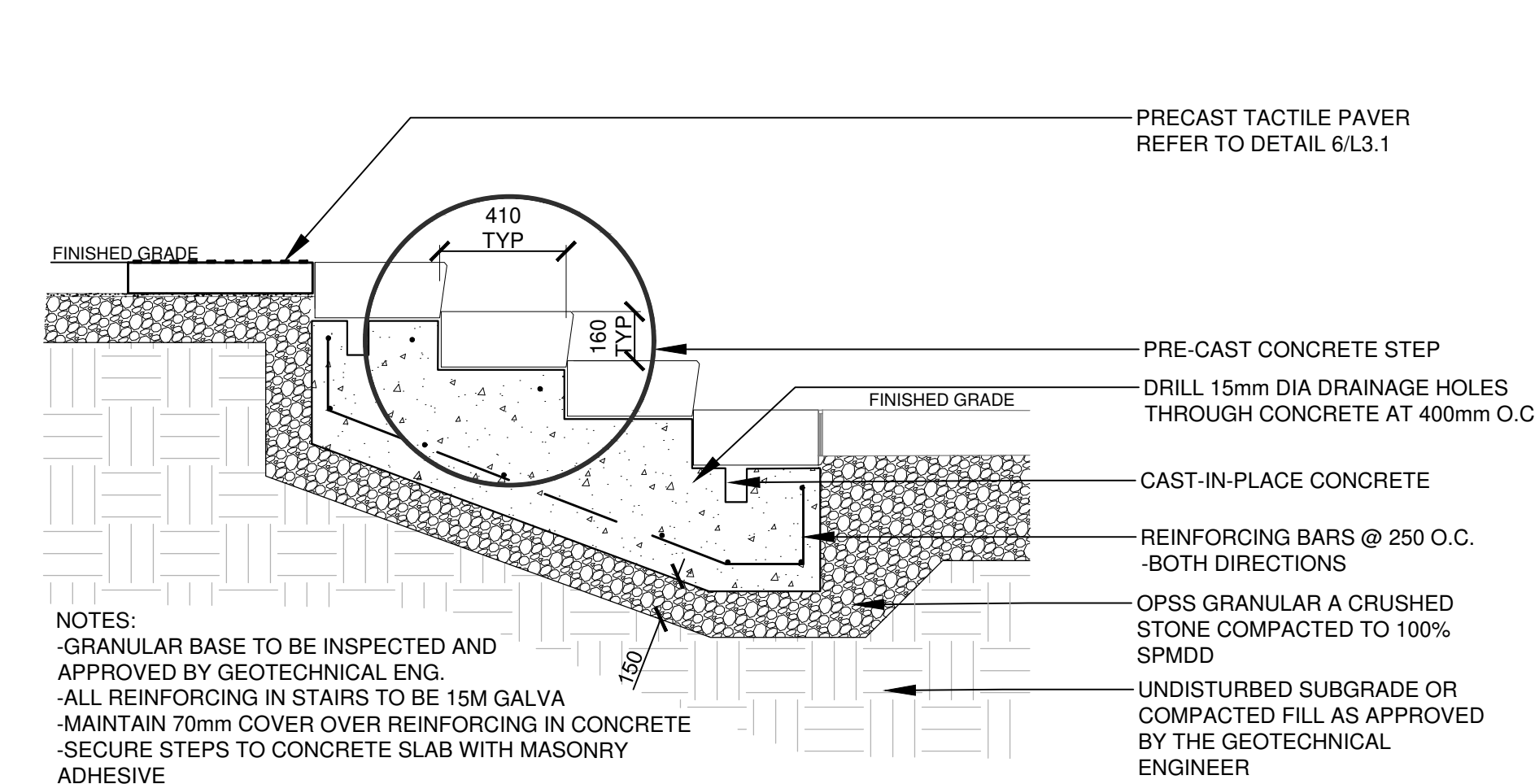

3
3.2 PRECAST CONCRETE STEPS ON C.I.P. FOOTING

SCALE - 1:20

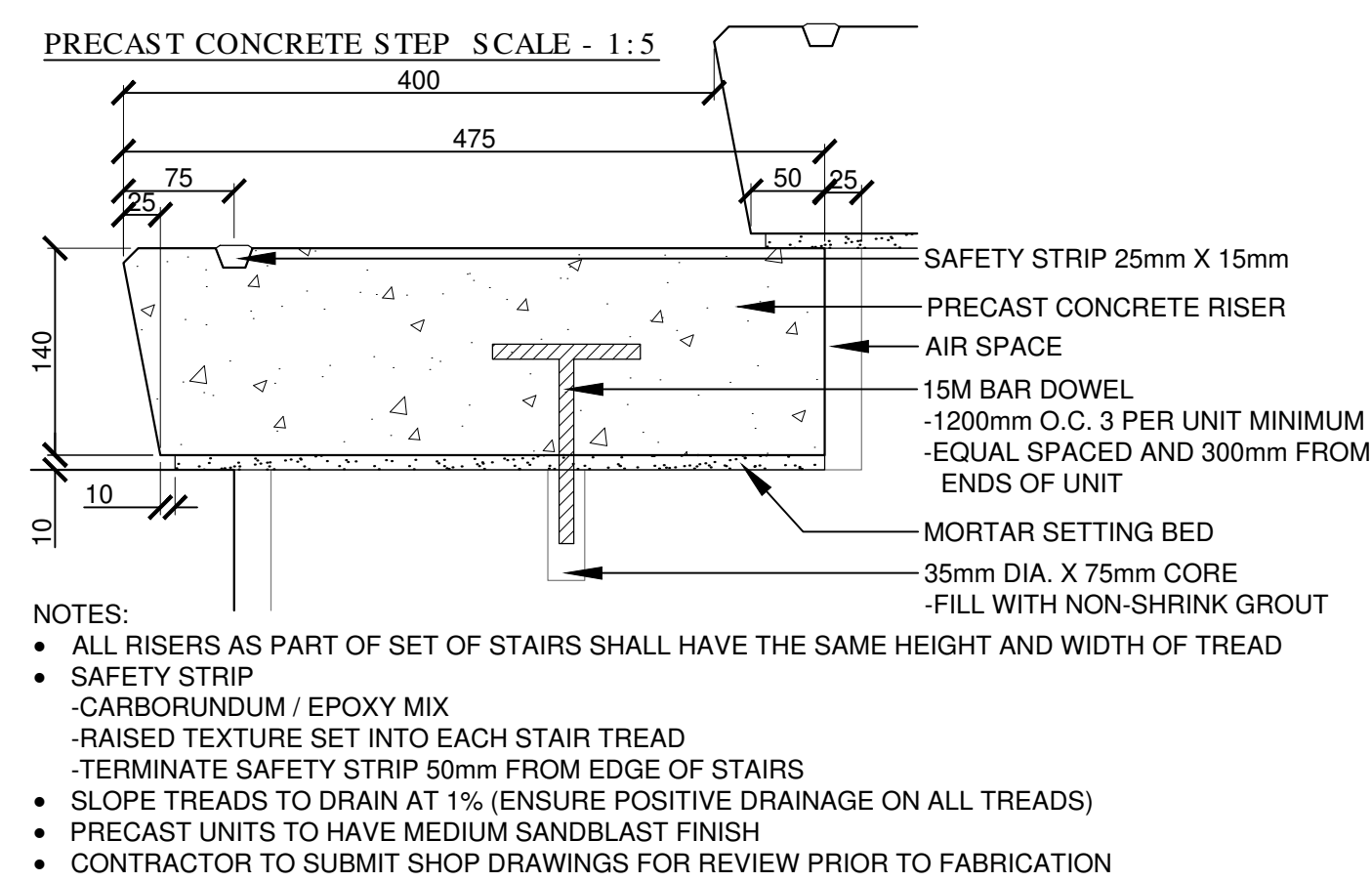

- NOTES:
- ALL RISERS AS PART OF SET OF STAIRS SHALL HAVE THE SAME HEIGHT AND WIDTH OF TREAD
 - SAFETY STRIP
 - CARBORUNDUM / EPOXY MIX
 - RAISED TEXTURE SET INTO EACH STAIR TREAD
 - TERMINATE SAFETY STRIP 50mm FROM EDGE OF STAIRS
 - SLOPE TREADS TO DRAIN AT 1% (ENSURE POSITIVE DRAINAGE ON ALL TREADS)
 - PRECAST UNITS TO HAVE MEDIUM SANDBLAST FINISH
 - CONTRACTOR TO SUBMIT SHOP DRAWINGS FOR REVIEW PRIOR TO FABRICATION

1	ISSUED FOR PRE-CONSULTATION	31 MAY, 2024
No.	Revision	Date

North:

Stamp:

Landscape Architecture
Urban Design
Site Planning
Recreation and Park Planning
Project Management

319 McRae Avenue, Suite 502, Ottawa, Ontario, K1Z 0B9
Tel: (613) 729-4536

1. All measurements in millimeters unless specified otherwise. Do not scale drawing. All drawings to be read in conjunction with written specifications.
2. Copyright reserved. This drawing is the exclusive property of CSW Landscape Architects Ltd. and shall not be used without the consent thereof.
3. This Drawing may not be used for construction until signed by the landscape architect. It is the responsibility of the contractor to:
 - check and verify all dimensions on site;
 - report all errors and/or omissions to the landscape architect;
 - comply with all pertinent codes and by-laws;
 - check and verify locations of all underground services with all local utilities prior to any digging.

Project:

**LANSDOWNE
EVENT CENTRE**

OTTAWA, ONTARIO

Drawing:

**LANDSCAPE DETAILS
PROPOSED DEVELOPMENT**

SHEET 4 OF 6

Scale:	Date:
AS SHOWN	MAY 2024
Design By:	Drawn By:
SE	SE
Project Number:	Sheet Number:
1766-12	L 3.2

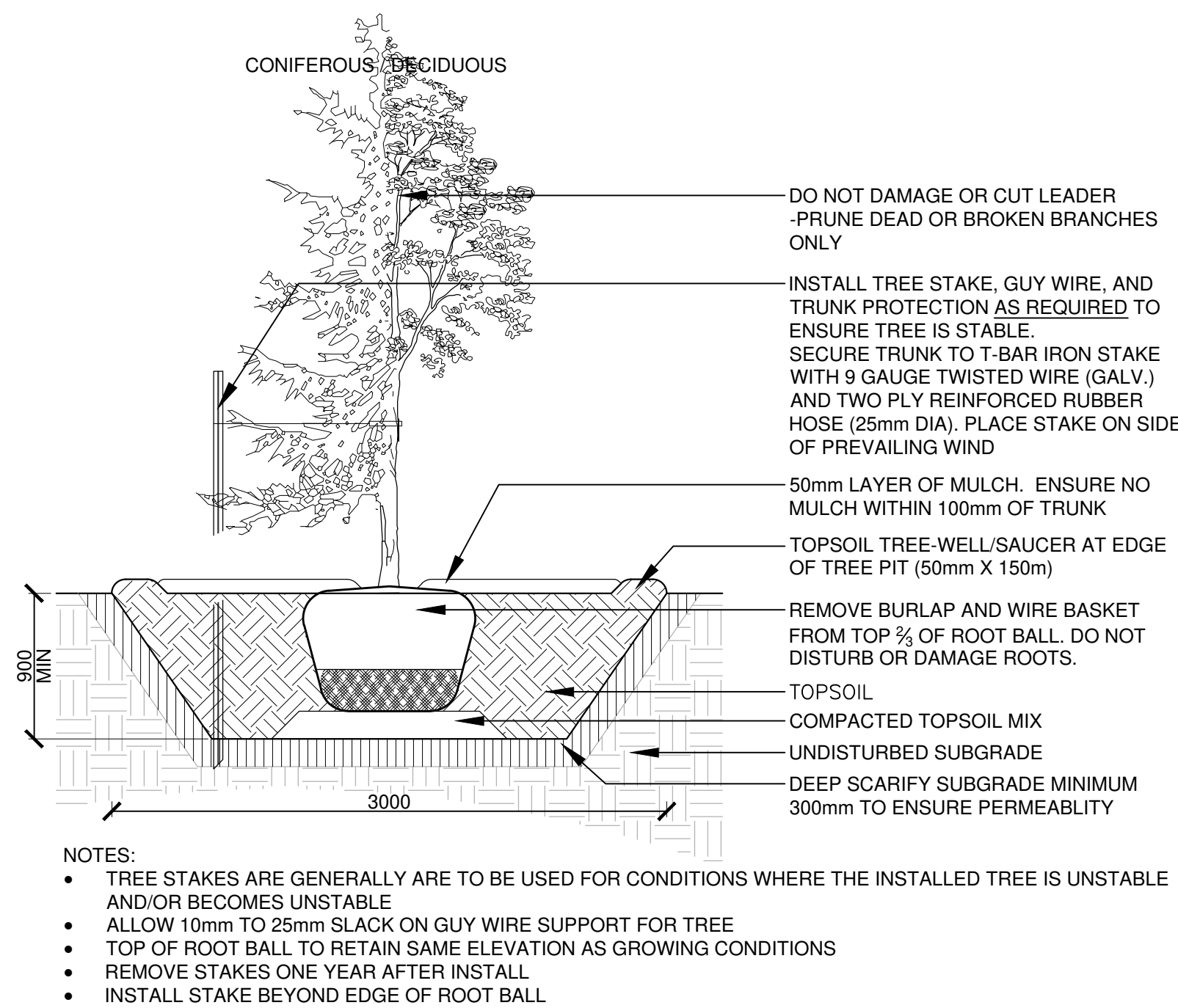

- NOTES:
- TREE STAKES ARE GENERALLY ARE TO BE USED FOR CONDITIONS WHERE THE INSTALLED TREE IS UNSTABLE AND/OR BECOMES UNSTABLE
 - ALLOW 10mm TO 25mm SLACK ON GUY WIRE SUPPORT FOR TREE
 - TOP OF ROOT BALL TO RETAIN SAME ELEVATION AS GROWING CONDITIONS
 - REMOVE STAKES ONE YEAR AFTER INSTALL
 - INSTALL STAKE BEYOND EDGE OF ROOT BALL

1 TREE PLANTING
3.3 SCALE - N.T.S.

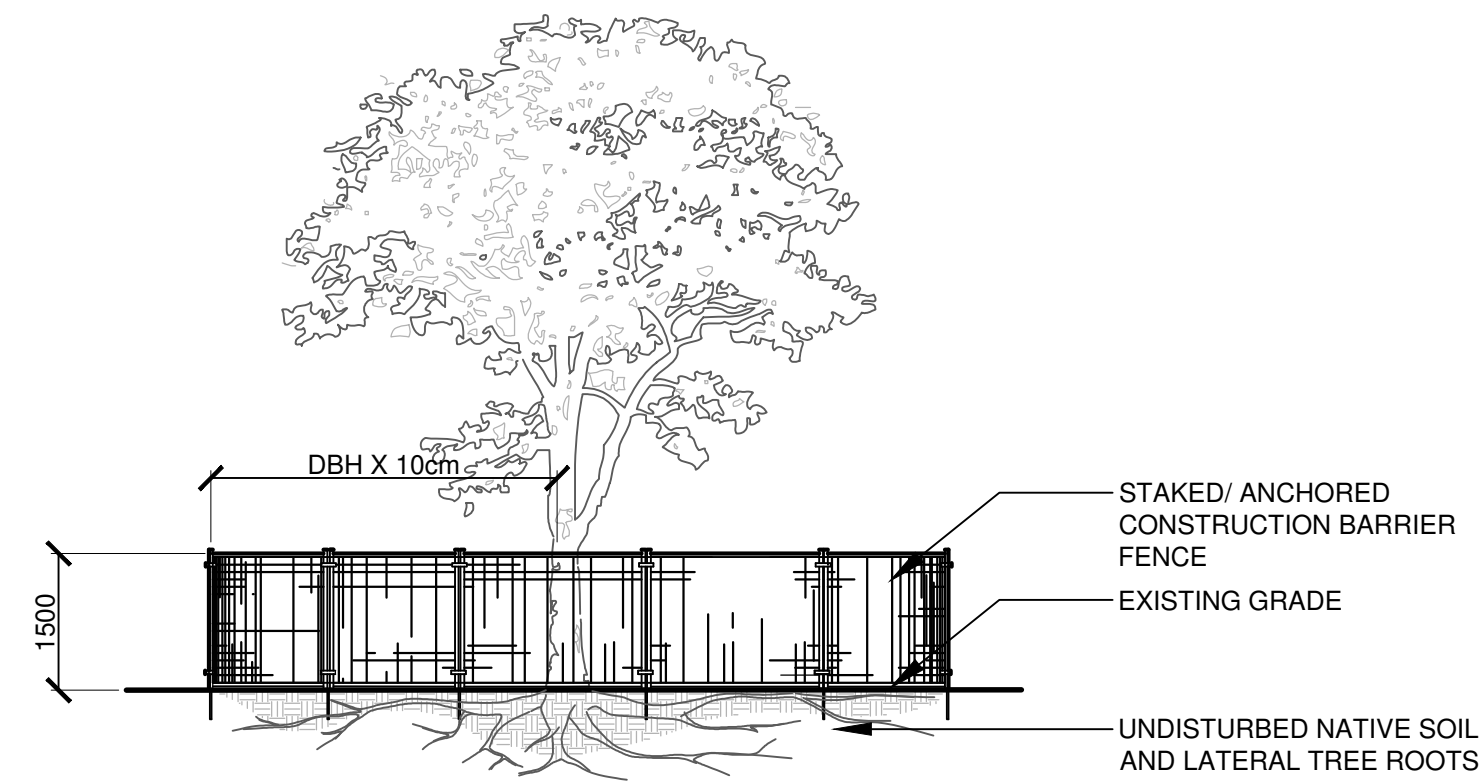

- NOTES:
- THE FOLLOWING PROTECTION MEASURES MUST BE IMPLEMENTED FOR RETAINED TREES, BOTH ON SITE AND ADJACENT SITES, PRIOR TO ANY TREE REMOVAL OR SITE WORKS AND MAINTAINED FOR THE DURATION OF CONSTRUCTION ON SITE.
- UNDER THE GUIDANCE OF AN ARBORIST, ERECT A FENCE AT THE CRITICAL ROOT ZONE (CRZ) OF TREES WHERE THE CRZ IS ESTABLISHED AS BEING 10 CENTIMETERS FROM THE TRUNK FOR EVERY CENTIMETER OF TRUNK DIAMETER AT BREAST HEIGHT. THE CRZ IS CALCULATED AS DBH X 10cm.
 - DO NOT PLACE ANY MATERIAL OR EQUIPMENT WITHIN THE CRZ OF THE TREE
 - DO NOT ATTACH ANY SIGNS, NOTICES OR POSTERS TO ANY TREE
 - DO NOT RAISE OR LOWER THE GRADE WITHIN THE CRZ WITHOUT APPROVAL
 - TUNNEL OR BORE WHEN DIGGING WITHIN THE CRZ OF A TREE
 - DO NOT DAMAGE THE ROOT SYSTEM, TRUNK, OR BRANCHES OR ANY TREE
 - ENSURE THAT EXHAUST FUMES FROM ALL EQUIPMENT ARE NOT DIRECTED TOWARDS ANY TREE CANOPY

4 TREE PROTECTION FENCE
3.3 SCALE - N.T.S.

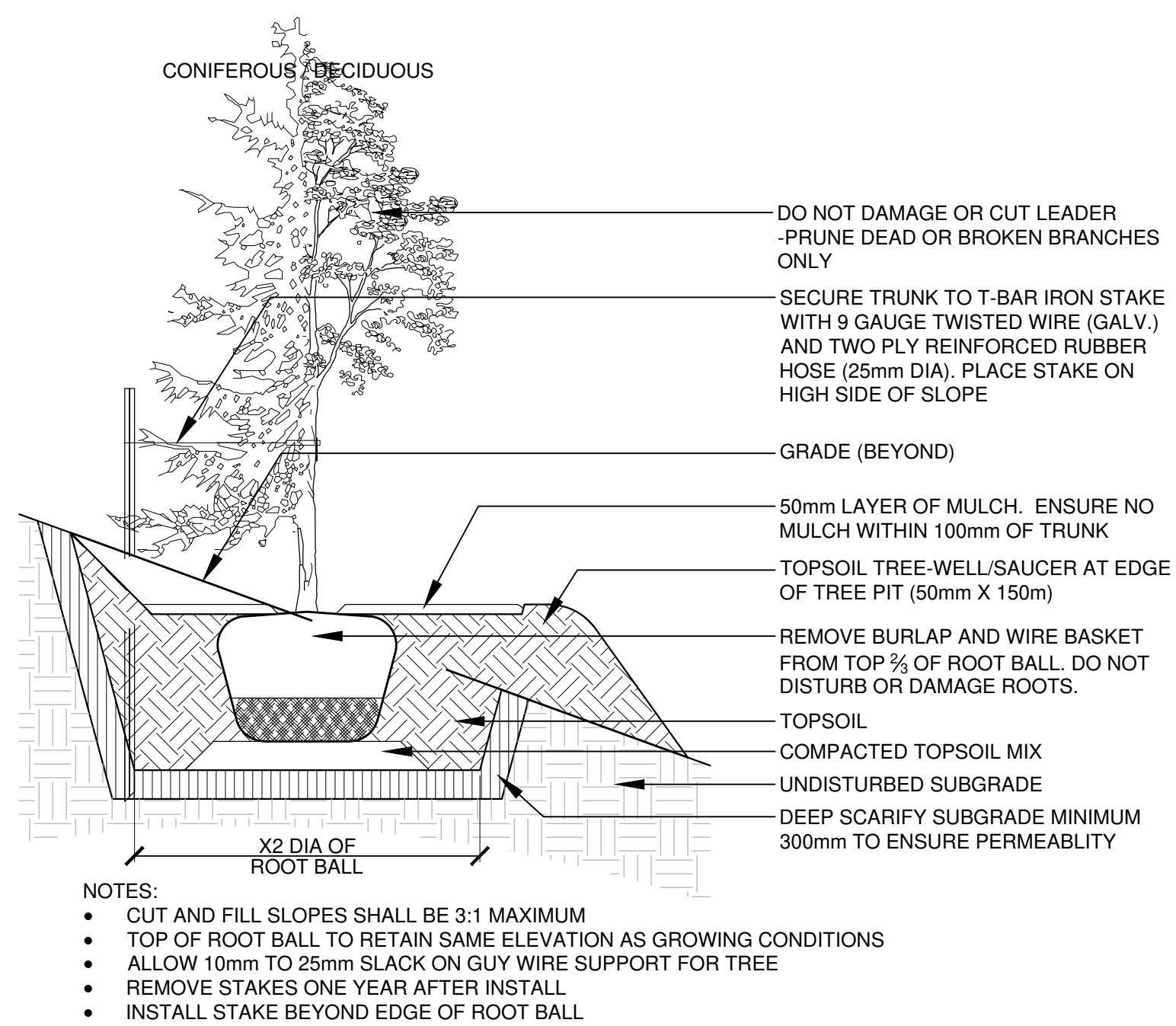

- NOTES:
- CUT AND FILL SLOPES SHALL BE 3:1 MAXIMUM
 - TOP OF ROOT BALL TO RETAIN SAME ELEVATION AS GROWING CONDITIONS
 - ALLOW 10mm TO 25mm SLACK ON GUY WIRE SUPPORT FOR TREE
 - REMOVE STAKES ONE YEAR AFTER INSTALL
 - INSTALL STAKE BEYOND EDGE OF ROOT BALL

2 TREE PLANTING ON SLOPE
3.3 SCALE - N.T.S.

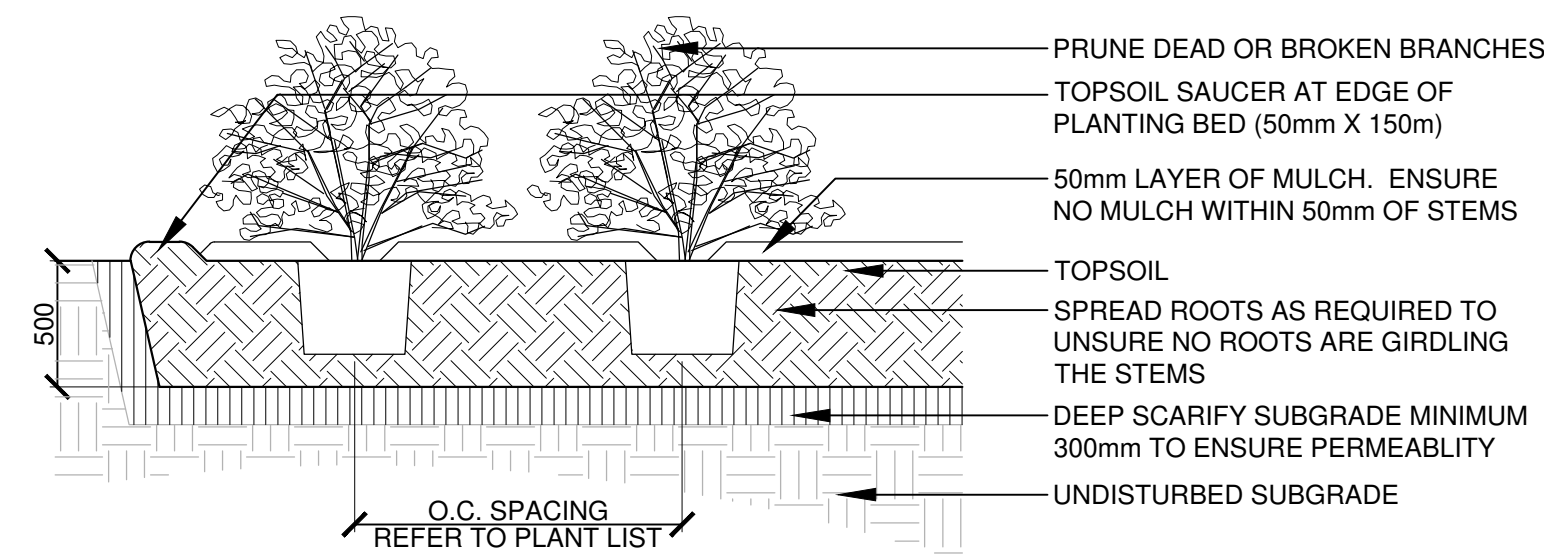

- NOTES:
- TOP OF ROOT BALL TO RETAIN SAME ELEVATION AS GROWING CONDITIONS

3 SHRUB / PERENNIAL PLANTING
3.3 SCALE - N.T.S.

CLIENT PARTNERSHIP



OTTAWA, ONTARIO CANADA

No.	Revision	Date
1	ISSUED FOR PRE-CONSULTATION	31 MAY, 2024

North:	Stamp:

CSW Landscape Architecture
Urban Design
Site Planning
Recreation and Park Planning
Project Management

319 McRae Avenue, Suite 502, Ottawa, Ontario, K1Z 0B9
Tel: (613) 729-4536

- All measurements in millimeters unless specified otherwise. Do not scale drawing. All drawings to be read in conjunction with written specifications.
- Copyright reserved. This drawing is the exclusive property of CSW Landscape Architects Ltd. and shall not be used without the consent thereof.
- This Drawing may not be used for construction until signed by the landscape architect. It is the responsibility of the contractor to:
 - check and verify all dimensions on site;
 - report all errors and/or omissions to the landscape architect;
 - comply with all pertinent codes and by-laws;
 - check and verify locations of all underground services with all local utilities prior to any digging.

Project:
**LANSDOWNE
EVENT CENTRE**

OTTAWA, ONTARIO

Drawing:
**LANDSCAPE DETAILS
PROPOSED DEVELOPMENT
SHEET 5 OF 6**

Scale: AS SHOWN	Date: MAY 2024
Design By: SE	Drawn By: SE
Project Number: 1766-12	Sheet Number: L 3.3

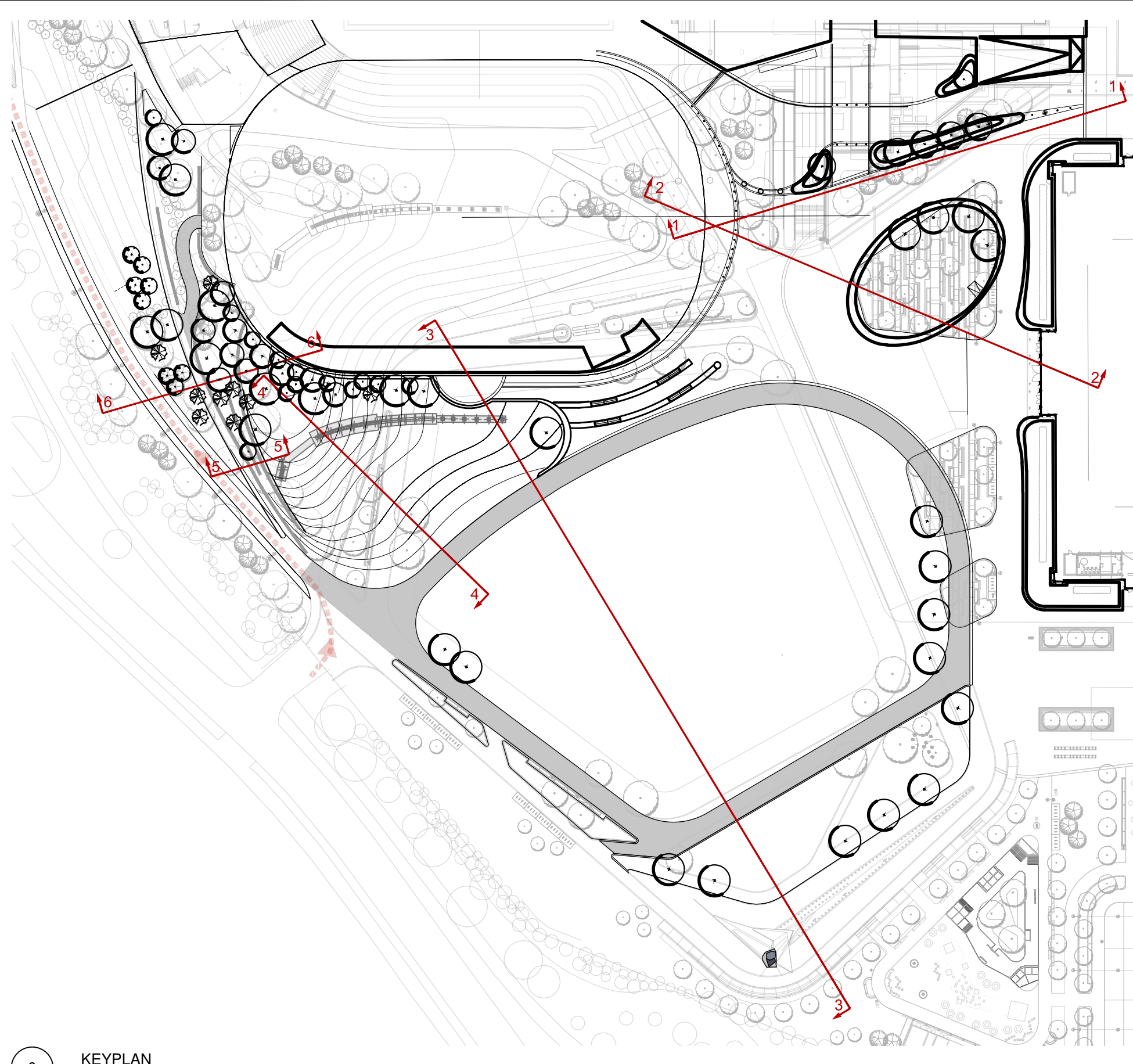

0 KEYPLAN Scale: 1:1000

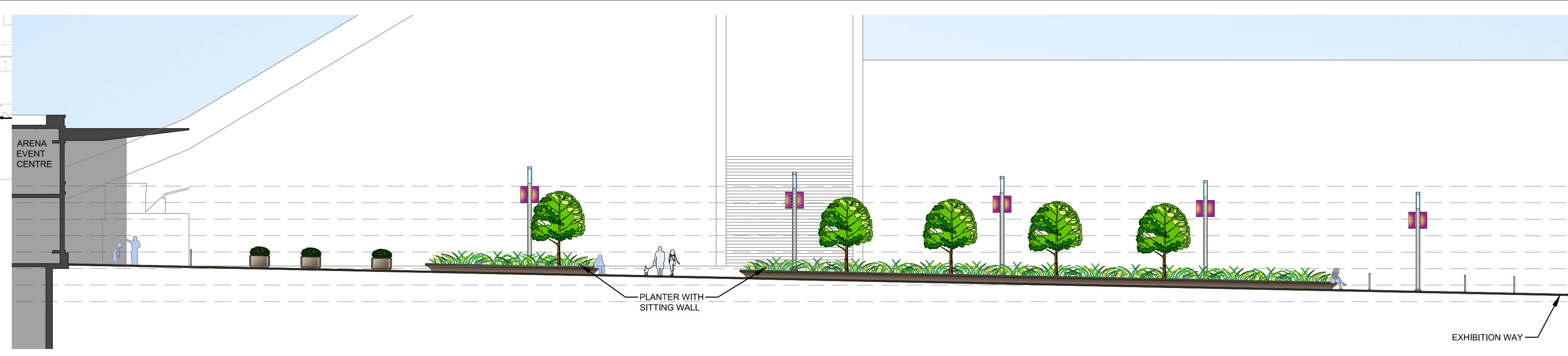

1 SECTION 1-1 Scale: 1:200

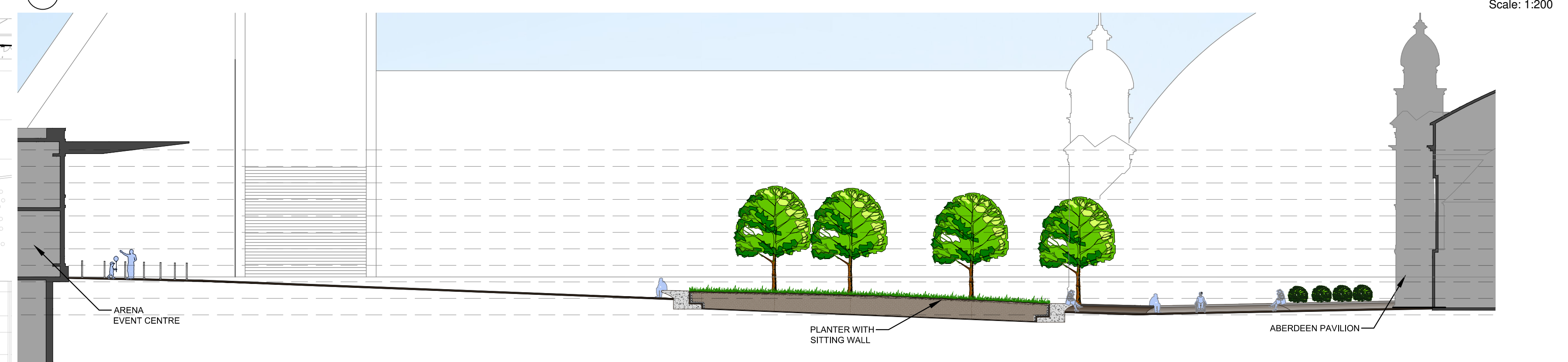

2 SECTION 2-2 Scale: 1:200



3 SECTION 3-3 Scale: 1:200

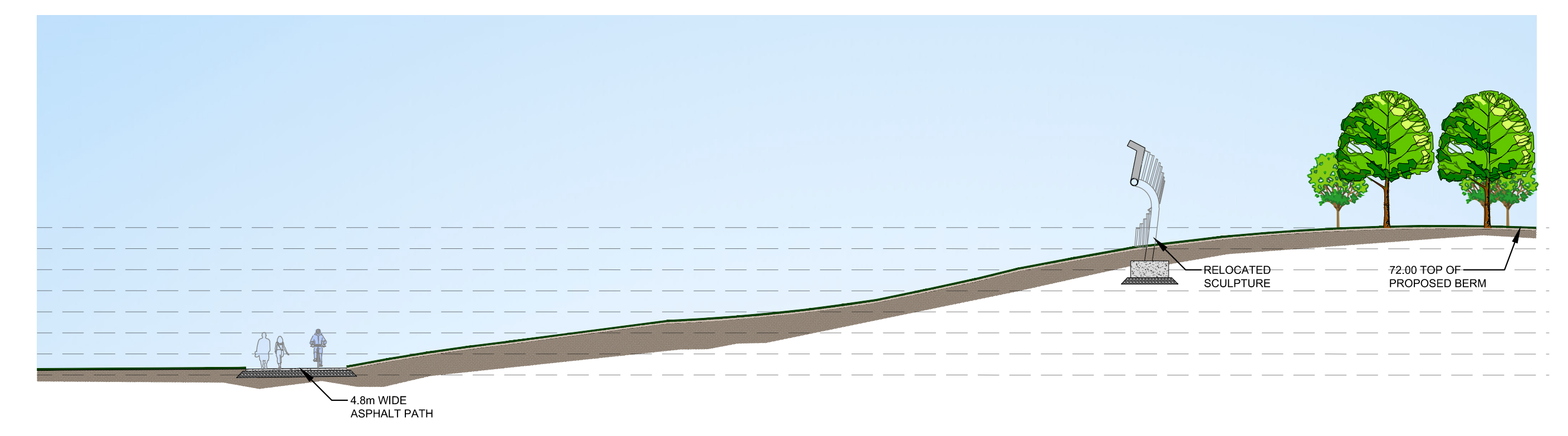

4 SECTION 4-4 Scale: 1:200

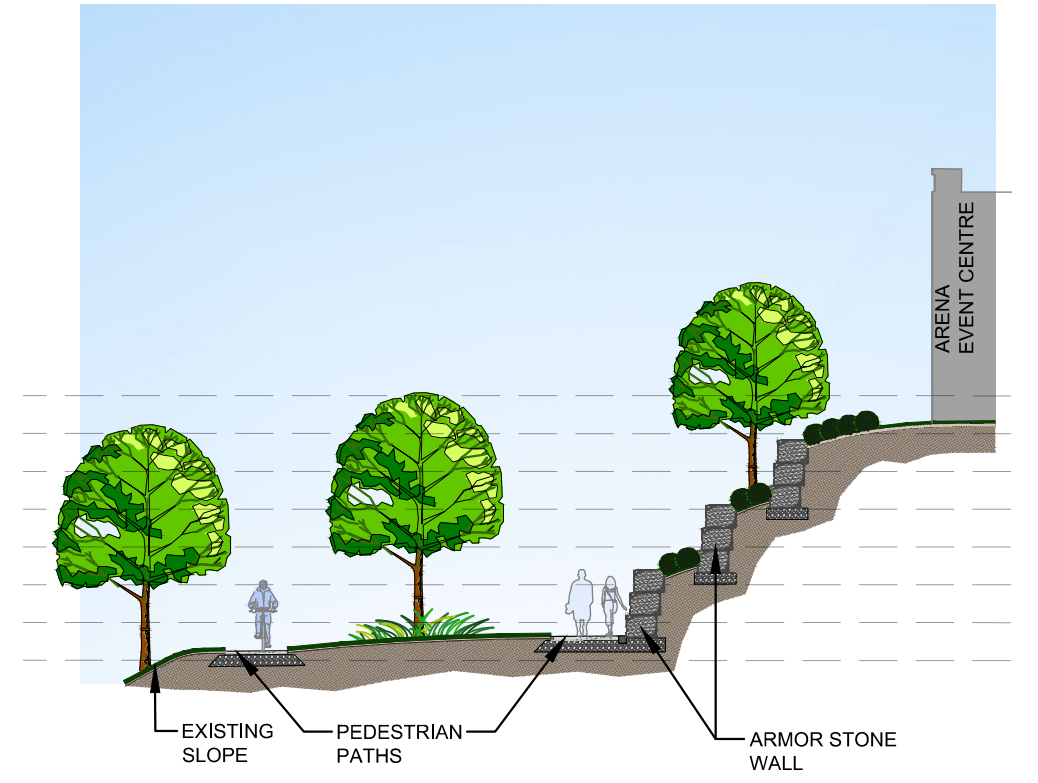

5 SECTION 5-5 Scale: 1:200

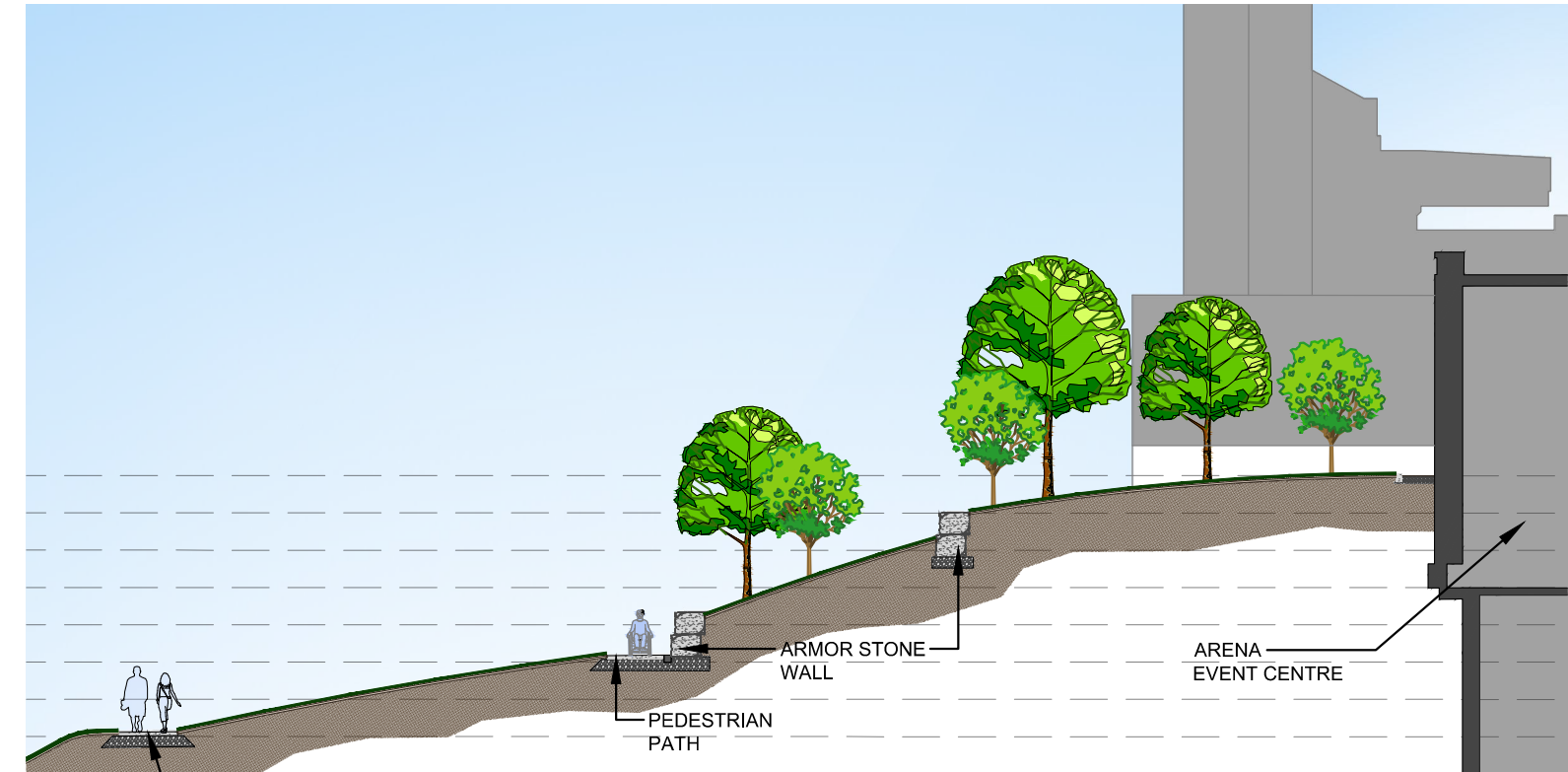

6 SECTION 6-6 Scale: 1:200

CLIENT PARTNERSHIP

OTTAWA, ONTARIO CANADA

1	ISSUED FOR PRE-CONSULTATION	31 MAY, 2024
No.	Revision	Date

North:

Stamp:

CSW Landscape Architecture
 Urban Design
 Site Planning
 Recreation and Park Planning
 Project Management

319 McRae Avenue, Suite 502, Ottawa, Ontario, K1Z 0B9
 Tel: (613) 729-4536

- All measurements in millimeters unless specified otherwise. Do not scale drawing. All drawings to be read in conjunction with written specifications.
- Copyright reserved. This drawing is the exclusive property of CSW Landscape Architects Ltd. and shall not be used without the consent thereof.
- This Drawing may not be used for construction until signed by the landscape architect. It is the responsibility of the contractor to:
 - check and verify all dimensions on site;
 - report all errors and/or omissions to the landscape architect;
 - comply with all pertinent codes and by-laws;
 - check and verify locations of all underground services with all local utilities prior to any digging.

Project: **LANSDOWNE EVENT CENTRE**
 OTTAWA., ONTARIO

Drawing: **CROSS - SECTIONS**
 SHEET 6 OF 6

Scale:	Date:
Design By: SE	Drawn By: SE
Project Number: 1766-12	Sheet Number: L4.0

Last Save: 6/7/2024 11:48:34 AM
 File Location: Z:\Projects\1766-12 Lansdowne Arena Park Redevelopment\Drawings\SPA\1766-12 Lansdowne Event Centre_SPA1_LandscapeSections\B1.dwg

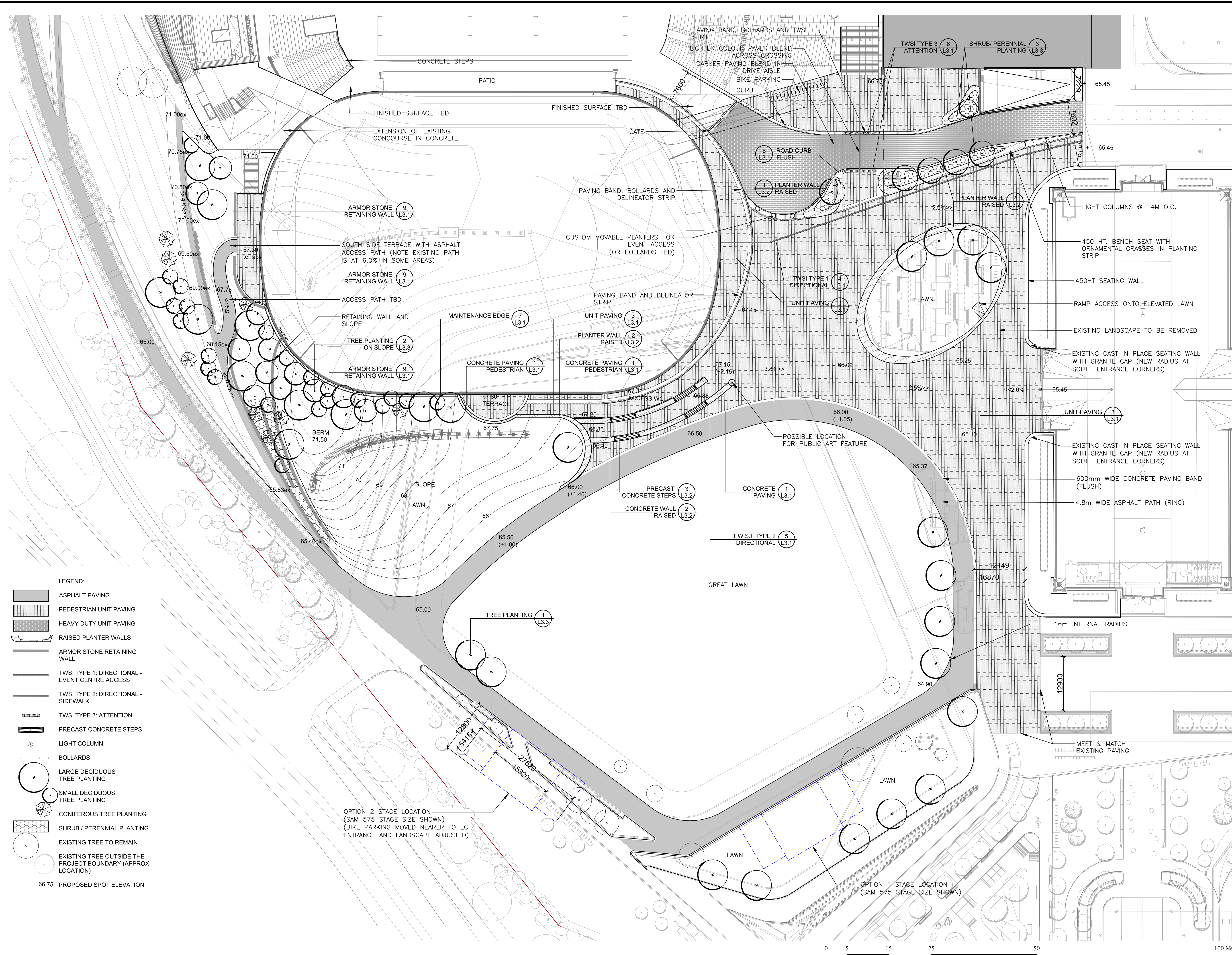

- LEGEND:**
- ASPHALT PAVING
 - PEDESTRIAN UNIT PAVING
 - HEAVY DUTY UNIT PAVING
 - RAISED PLANTER WALLS
 - ARMOR STONE RETAINING WALL
 - TWSI TYPE 1: DIRECTIONAL - EVENT CENTRE ACCESS
 - TWSI TYPE 2: DIRECTIONAL - SIDEWALK
 - TWSI TYPE 3: ATTENTION
 - PRECAST CONCRETE STEPS
 - LIGHT COLUMN
 - BOLLARDS
 - LARGE DECIDUOUS TREE PLANTING
 - SMALL DECIDUOUS TREE PLANTING
 - CONIFEROUS TREE PLANTING
 - SHRUB / PERENNIAL PLANTING
 - EXISTING TREE TO REMAIN
 - EXISTING TREE OUTSIDE THE PROJECT BOUNDARY (APPROX. LOCATION)
- 66.75 PROPOSED SPOT ELEVATION

1	ISSUED FOR PRE-CONSULTATION	31 MAY, 2024
No.	Revision	Date

North:

Stamp:

CSW Landscape Architecture
Urban Design
Site Planning
Recreation and Park Planning
Project Management

319 McRae Avenue, Suite 502, Ottawa, Ontario, K1Z 0B9
Tel: (613) 729-4536

- All measurements in millimeters unless specified otherwise. Do not scale drawing. All drawings to be read in conjunction with written specifications.
- Copyright reserved. This drawing is the exclusive property of CSW Landscape Architects Ltd. and shall not be used without the consent thereof.
- This Drawing may not be used for construction until signed by the landscape architect. It is the responsibility of the contractor to:
 - check and verify all dimensions on site;
 - report all errors and/or omissions to the landscape architect;
 - comply with all pertinent codes and by-laws;
 - check and verify locations of all underground services with all local utilities prior to any digging.

Project: **LANSDOWNE EVENT CENTRE**

OTTAWA, ONTARIO

Drawing: **LANDSCAPE LAYOUT PLAN**

SHEET 1 OF 6

Scale: 1:400	Date: MAR 2024
Design By: SE	Drawn By: JA
Project Number: 1766-12	Sheet Number: L1.0



HOLMWOOD AVENUE

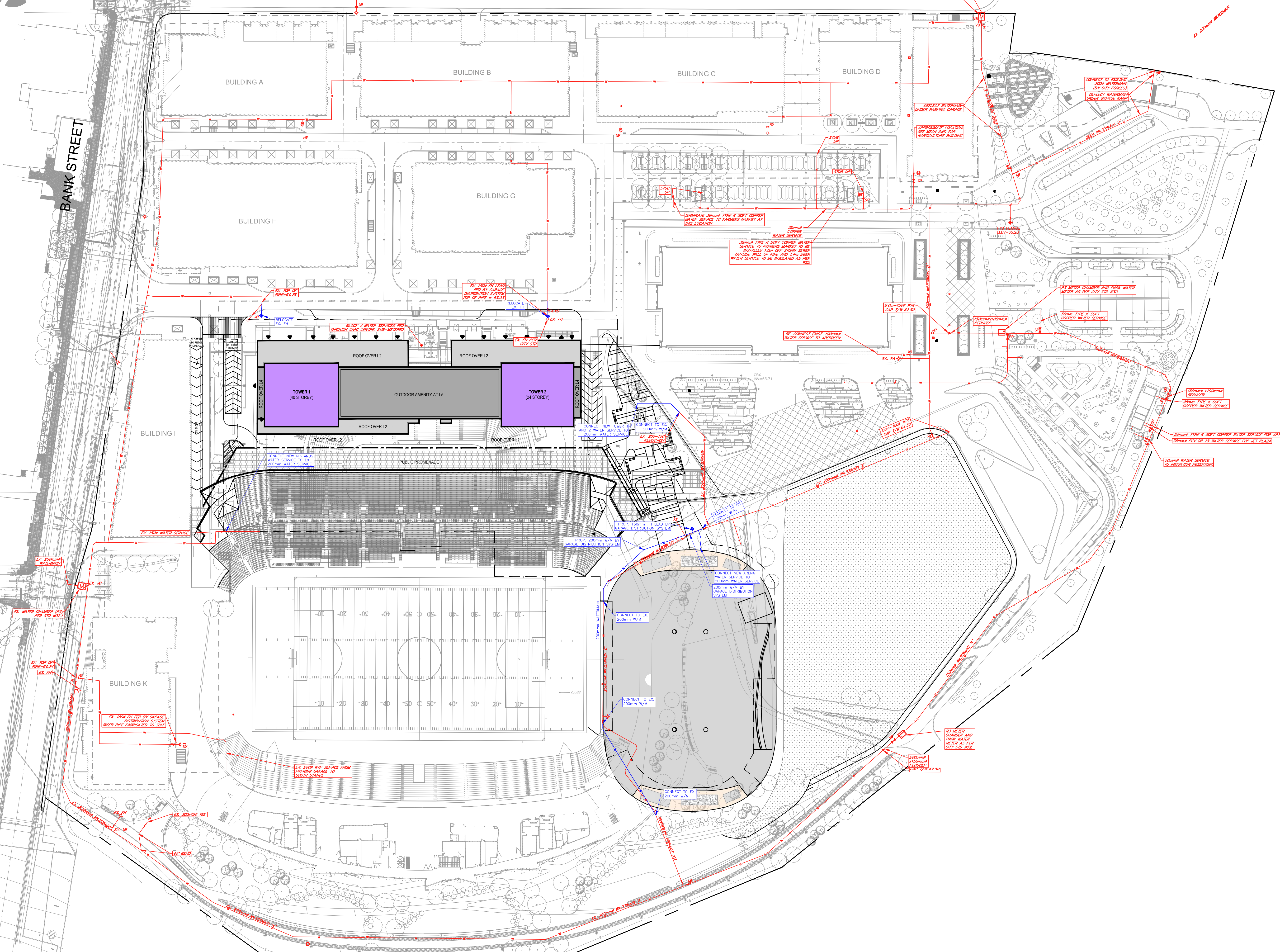

CLIENT REF. #

wsp

WSP CANADA INC.
2611 QUEENSWAY DR #300,
OTTAWA, ONTARIO
CANADA K0B 8K2
PHONE: 613-829-2800
WWW.WSP.COM

PROJECT NUMBER: CA0000286.1662

CONSULTANT TEAM:

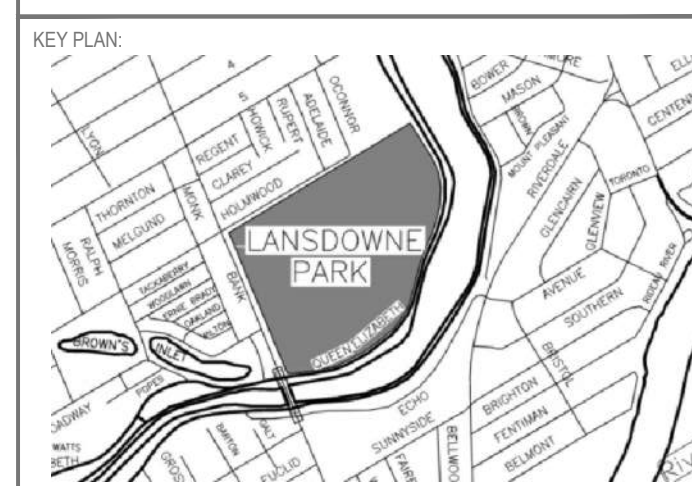

DISCLAIMER: THIS DRAWING AND DESIGN IS COPYRIGHT PROTECTED WHICH SHALL NOT BE USED, REPRODUCED OR REVISED WITHOUT WRITTEN PERMISSION BY WSP. THE CONTRACTOR SHALL CHECK AND VERIFY ALL DIMENSIONS AND UTILITY LOCATIONS AND REPORT ALL ERRORS AND OMISSIONS PRIOR TO COMMENCING WORK.

REVISION:

REV	DATE	DESCRIPTION	BY
2	2023-09-22	ISSUED FOR CITY REVIEW	DY
1	2023-05-25	ISSUED FOR CITY REVIEW	DY

ORIGINAL SCALE: 1:750 DATE: 2023-09-22

DRAWN BY: JT

CHECKED BY: DY

APPROVED BY: DY

IF THIS BAR IS NOT 25mm LONG, ADJUST YOUR PLOTTING SCALE.

CA0000286.1662

DISCIPLINE:

CIVIL

TITLE:

CONCEPTUAL
WATER SERVICING

PROJECT:
LANDSDOWN PARK
REDEVELOPMENT
EXHIBITION WAY
OTTAWA, ONTARIO

DRAWING NUMBER: F1 REV. 0A

C:\Users\jtopson\OneDrive\Desktop\2458.mxd
 FILE: \\110-13.mxd 2023-09-22 1:52 PM
 PLOTTED: 2023-09-22 1:52 PM
 FILE: \\110-13.mxd 2023-09-22 1:52 PM
 PLOTTED: 2023-09-22 1:52 PM



HOLMWOOD AVENUE

BUILDING A

BUILDING B

BUILDING C

BUILDING D

BUILDING G

BUILDING H

BUILDING I

TOWER 1 (40 STOREY)

OUTDOOR AMENITY AT L5

TOWER 2 (24 STOREY)

PUBLIC PROMENADE

BUILDING K



CLIENT REF. #



WSP CANADA INC.
2611 QUEENSVIEW DR #300,
OTTAWA, ONTARIO
CANADA K3B 9K2
PHONE: 613-829-2800
WWW.WSP.COM

PROJECT NUMBER: CA0000286.1662

CONSULTANT TEAM

KEY PLAN:



DISCLAIMER: THIS DRAWING AND DESIGN IS COPYRIGHT PROTECTED WHICH SHALL NOT BE USED, REPRODUCED OR REVISED WITHOUT WRITTEN PERMISSION BY WSP. THE CONTRACTOR SHALL CHECK AND VERIFY ALL DIMENSIONS AND UTILITY LOCATIONS AND REPORT ALL ERRORS AND OMISSIONS PRIOR TO COMMENCING WORK.

REVISION:

2	2023-09-22	ISSUED FOR CITY REVIEW	DY
1	2023-05-25	ISSUED FOR CITY REVIEW	DY

ORIGINAL SCALE: 1:750 DATE: 2023-09-22

DRAWN BY: JT
CHECKED BY: DY
APPROVED BY: DY

IF THIS BAR IS NOT 25mm LONG, ADJUST YOUR PLOTTING SCALE.



CA0000286.1662

DISCIPLINE:

CIVIL

TITLE:

CONCEPTUAL
SANITARY SERVICING

PROJECT:

LANDSDOWN PARK
REDEVELOPMENT
EXHIBITION WAY
OTTAWA, ONTARIO

DRAWING NUMBER:

F2

REV.

0A

FILE: \\10-13.mv.2023.projects\ca0000286.1662.landsdowne.2.01.1.0.1.mv.dwg and revision\1.0.1.civil.dwg
PLOTTED: 2023-09-22 1:58 PM
C:\Users\jtopson\OneDrive\Documents\2023-09-22 1:58 PM



HOLMWOOD AVENUE



CLIENT REF. #



WSP CANADA INC.
2611 QUEENSVIEW DR #300,
OTTAWA, ONTARIO
CANADA K2B 9K2
PHONE: 613-829-2800
WWW.WSP.COM

PROJECT NUMBER: CA000286.1662

CONSULTANT TEAM:

KEY PLAN:



DISCLAIMER: THIS DRAWING AND DESIGN IS COPYRIGHT PROTECTED WHICH SHALL NOT BE USED, REPRODUCED OR REVISED WITHOUT WRITTEN PERMISSION BY WSP. THE CONTRACTOR SHALL CHECK AND VERIFY ALL DIMENSIONS AND UTILITY LOCATIONS AND REPORT ALL ERRORS AND OMISSIONS PRIOR TO COMMENCING WORK.

REVISION:

REV	DATE	DESCRIPTION	BY
2	2023-09-22	ISSUED FOR CITY REVIEW	DY
1	2023-05-25	ISSUED FOR CITY REVIEW	DY

ORIGINAL SCALE:	DATE: 2023-09-22
1:750	

DRAWN BY:	JT
CHECKED BY:	DY
APPROVED BY:	DY

IF THIS BAR IS NOT 25mm LONG, ADJUST YOUR PLOTTING SCALE.

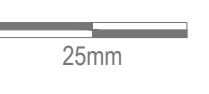

CA000286.1662

DISCIPLINE:

CIVIL

TITLE:

CONCEPTUAL STORM SERVICING

PROJECT:

LANDSDOWN PARK
REDEVELOPMENT
EXHIBITION WAY
OTTAWA, ONTARIO

DRAWING NUMBER:

F3

REV.

0A

FILE: \\10-13.mv.2023.projects\ca000286.1662.landsdown.2.01.4.0.tsd_and_services\1.60_civil3.dwg
PLOT: 2023-09-22 2:02 PM

CA000286.1662.landsdown.2.01.4.0.tsd_and_services\1.60_civil3.dwg

2023-09-22 2:02 PM

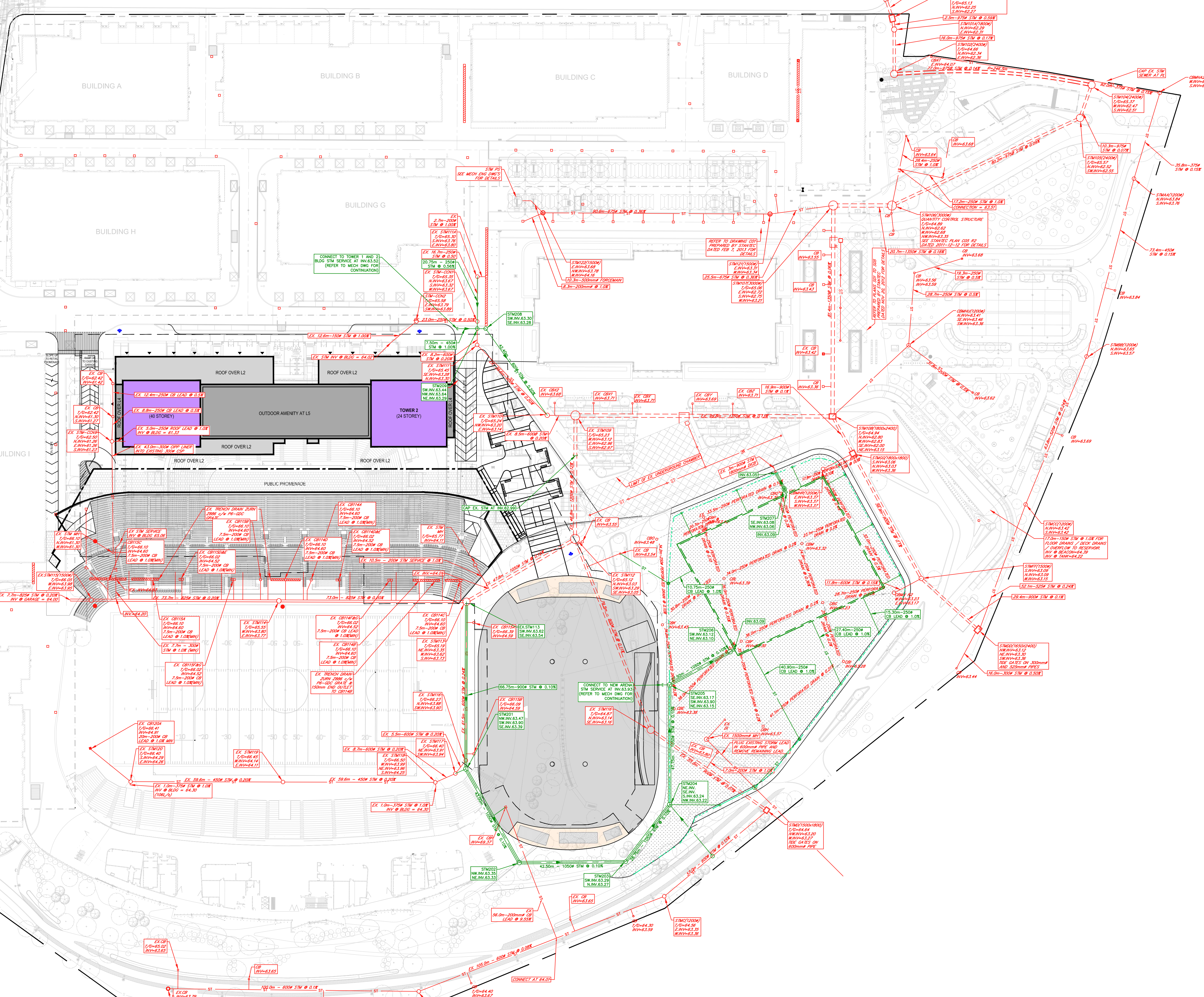

SITE LEGEND

- 1 EXISTING NORTH STANDS
- 2 SOUTH STANDS
- 3 GREAT LAWN
- 4 ABERDEEN PAVILION

SHADOW LEGEND

- PROPOSED SHADOW LINE
- PROPOSED DEVELOPMENT
- NEW NET SHADOW

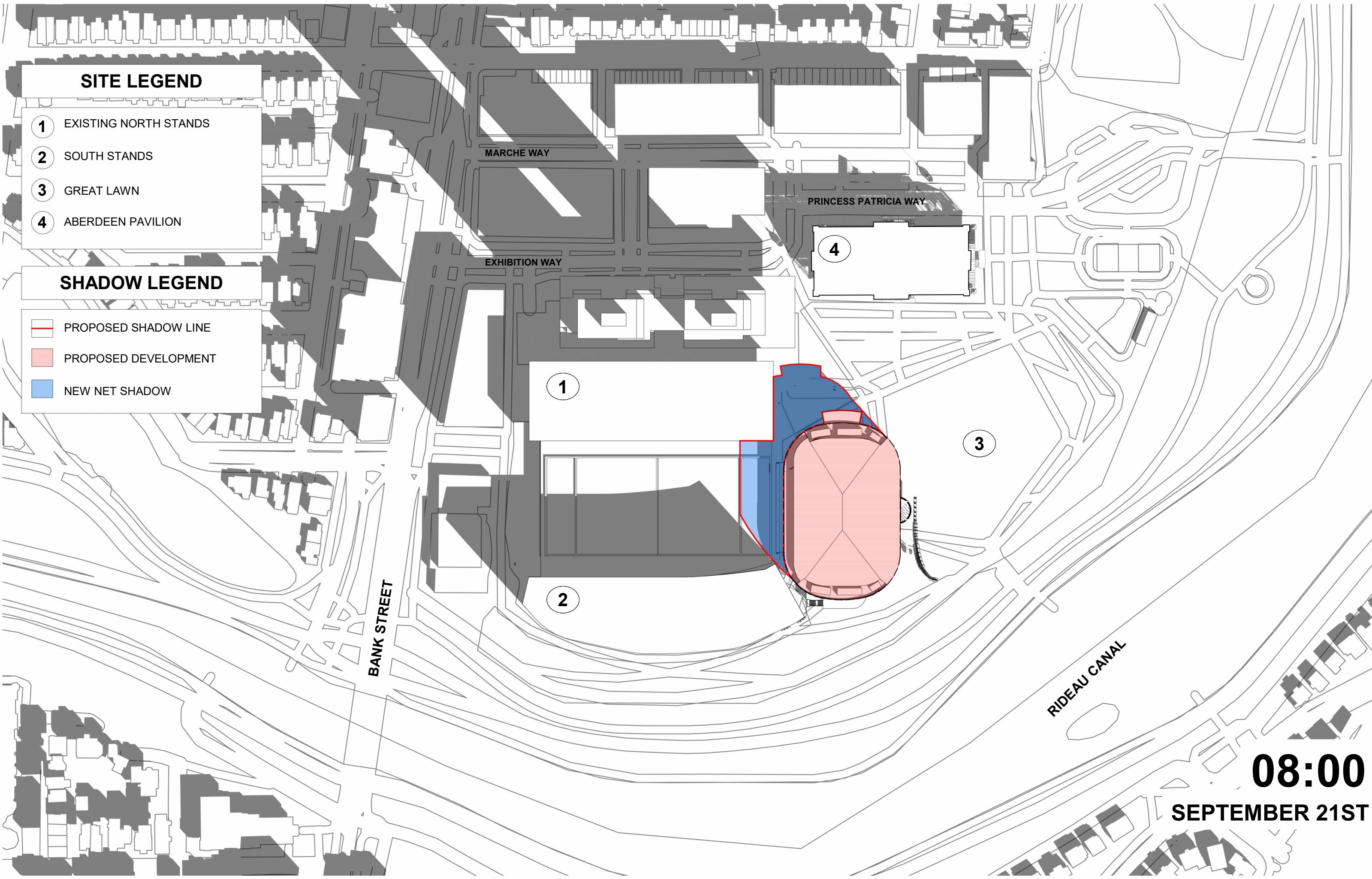

08:00
SEPTEMBER 21ST

SITE LEGEND

- 1 EXISTING NORTH STANDS
- 2 SOUTH STANDS
- 3 GREAT LAWN
- 4 ABERDEEN PAVILION

SHADOW LEGEND

- PROPOSED SHADOW LINE
- PROPOSED DEVELOPMENT
- NEW NET SHADOW

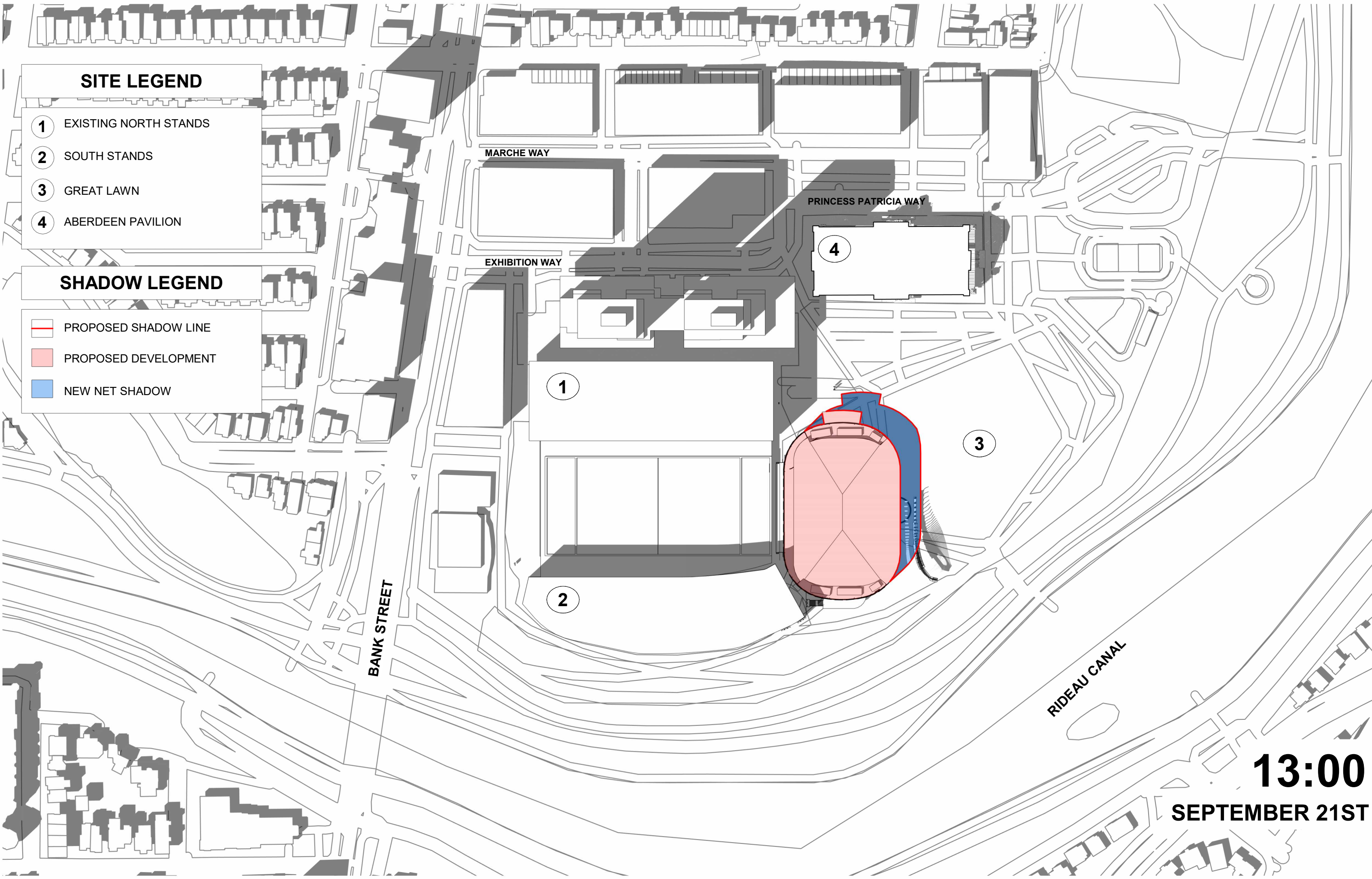

13:00
SEPTEMBER 21ST

SITE LEGEND

- 1 EXISTING NORTH STANDS
- 2 SOUTH STANDS
- 3 GREAT LAWN
- 4 ABERDEEN PAVILION

SHADOW LEGEND

- PROPOSED SHADOW LINE
- PROPOSED DEVELOPMENT
- NEW NET SHADOW



18:00
SEPTEMBER 21ST

SITE LEGEND

- 1 EXISTING NORTH STANDS
- 2 SOUTH STANDS
- 3 GREAT LAWN
- 4 ABERDEEN PAVILION

SHADOW LEGEND

- PROPOSED SHADOW LINE
- PROPOSED DEVELOPMENT
- NEW NET SHADOW

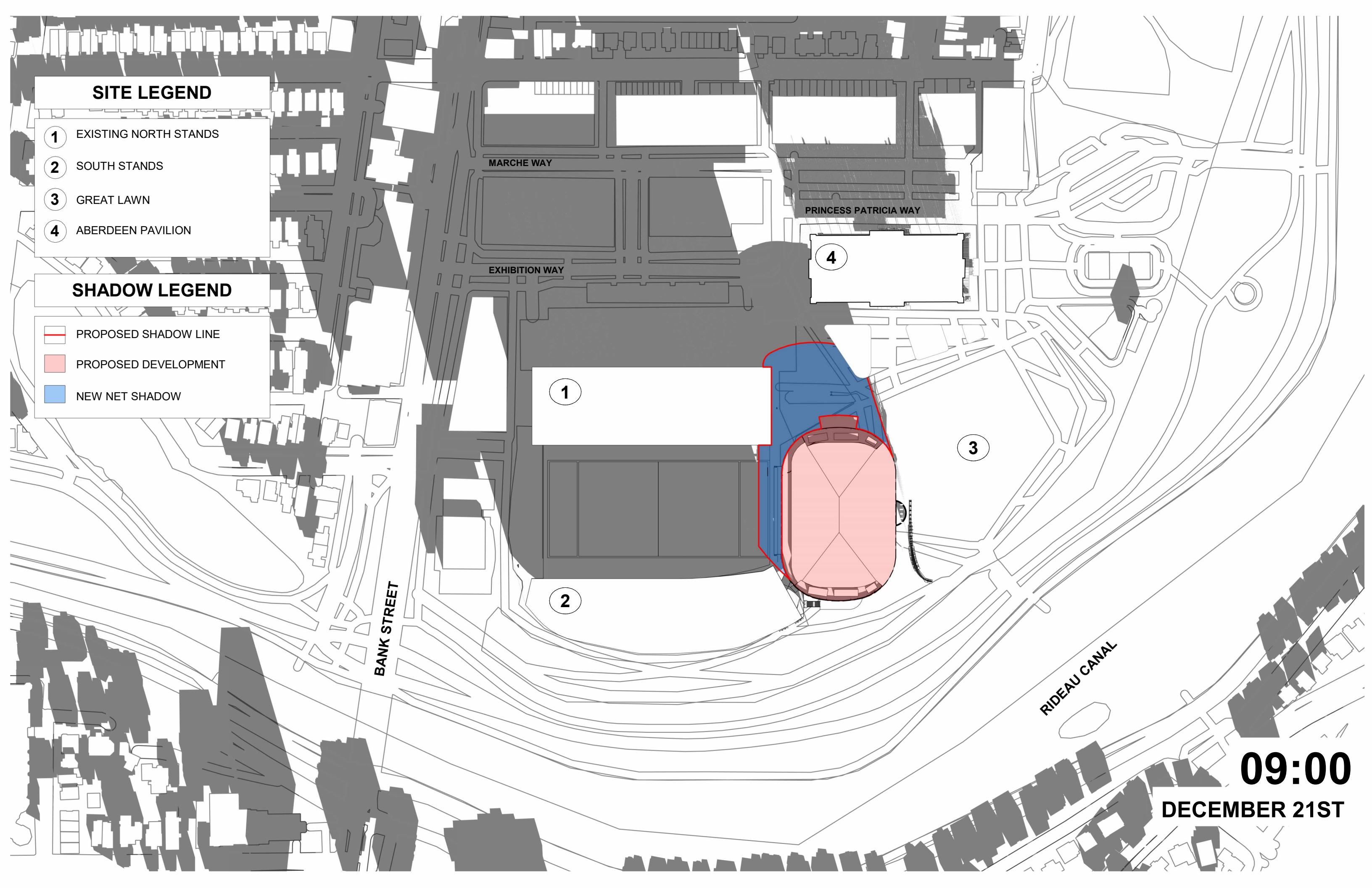

09:00
DECEMBER 21ST

SITE LEGEND

- 1 EXISTING NORTH STANDS
- 2 SOUTH STANDS
- 3 GREAT LAWN
- 4 ABERDEEN PAVILION

SHADOW LEGEND

- PROPOSED SHADOW LINE
- PROPOSED DEVELOPMENT
- NEW NET SHADOW

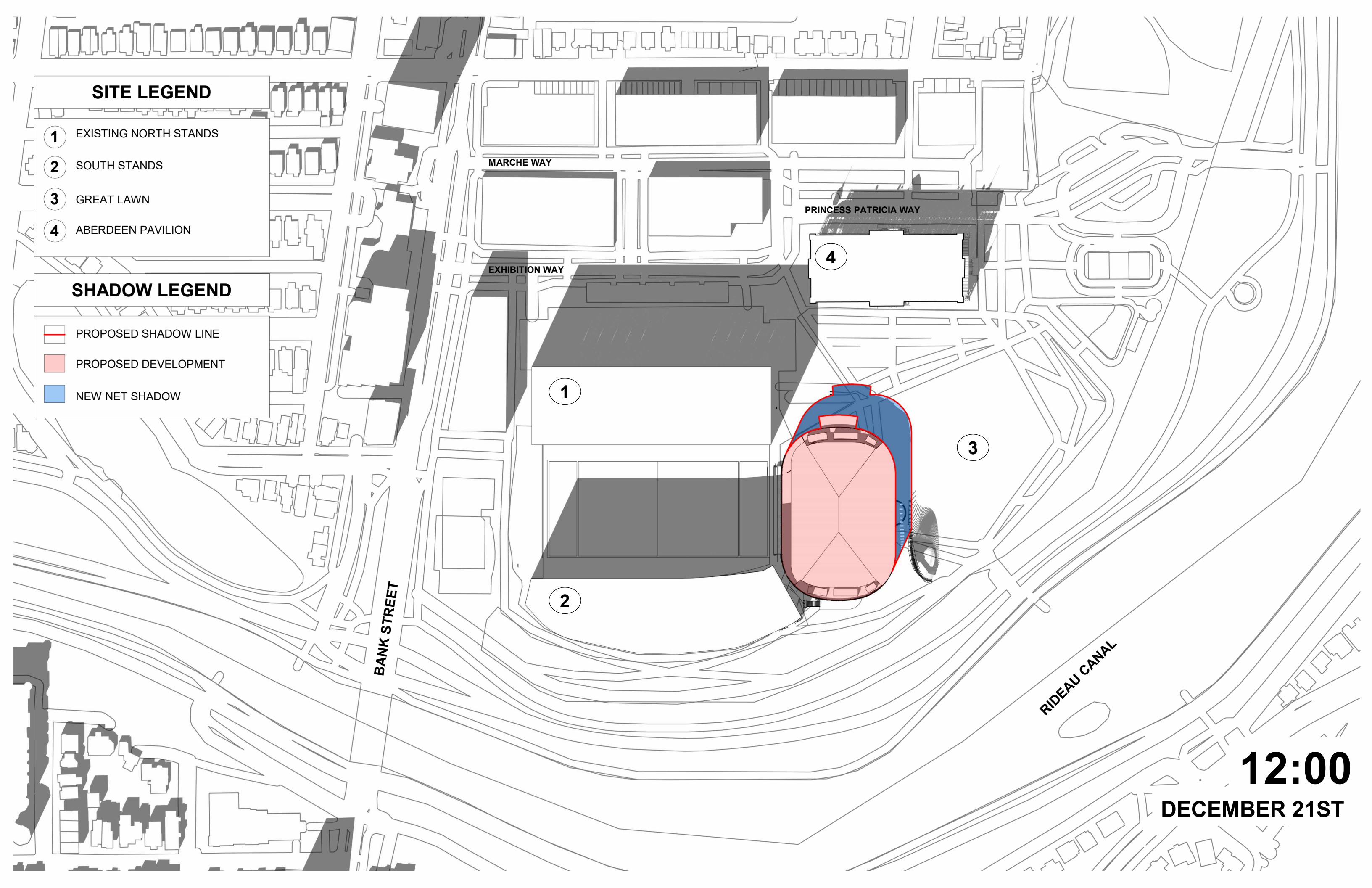

12:00
DECEMBER 21ST

SITE LEGEND

- 1 EXISTING NORTH STANDS
- 2 SOUTH STANDS
- 3 GREAT LAWN
- 4 ABERDEEN PAVILION

SHADOW LEGEND

- PROPOSED SHADOW LINE
- PROPOSED DEVELOPMENT
- NEW NET SHADOW

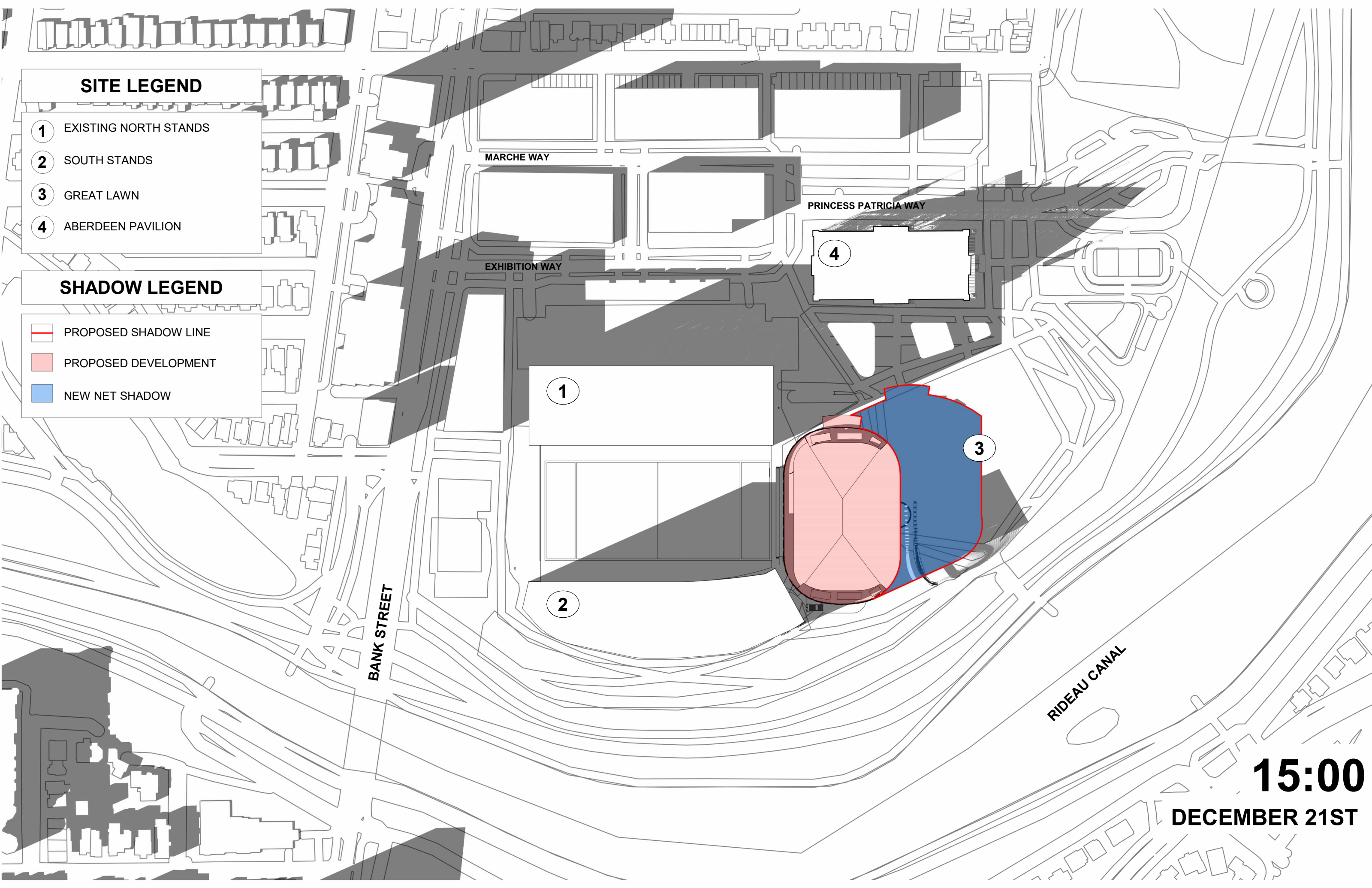

15:00
DECEMBER 21ST

SITE LEGEND

- 1 EXISTING NORTH STANDS
- 2 SOUTH STANDS
- 3 GREAT LAWN
- 4 ABERDEEN PAVILION

SHADOW LEGEND

- PROPOSED SHADOW LINE
- PROPOSED DEVELOPMENT
- NEW NET SHADOW

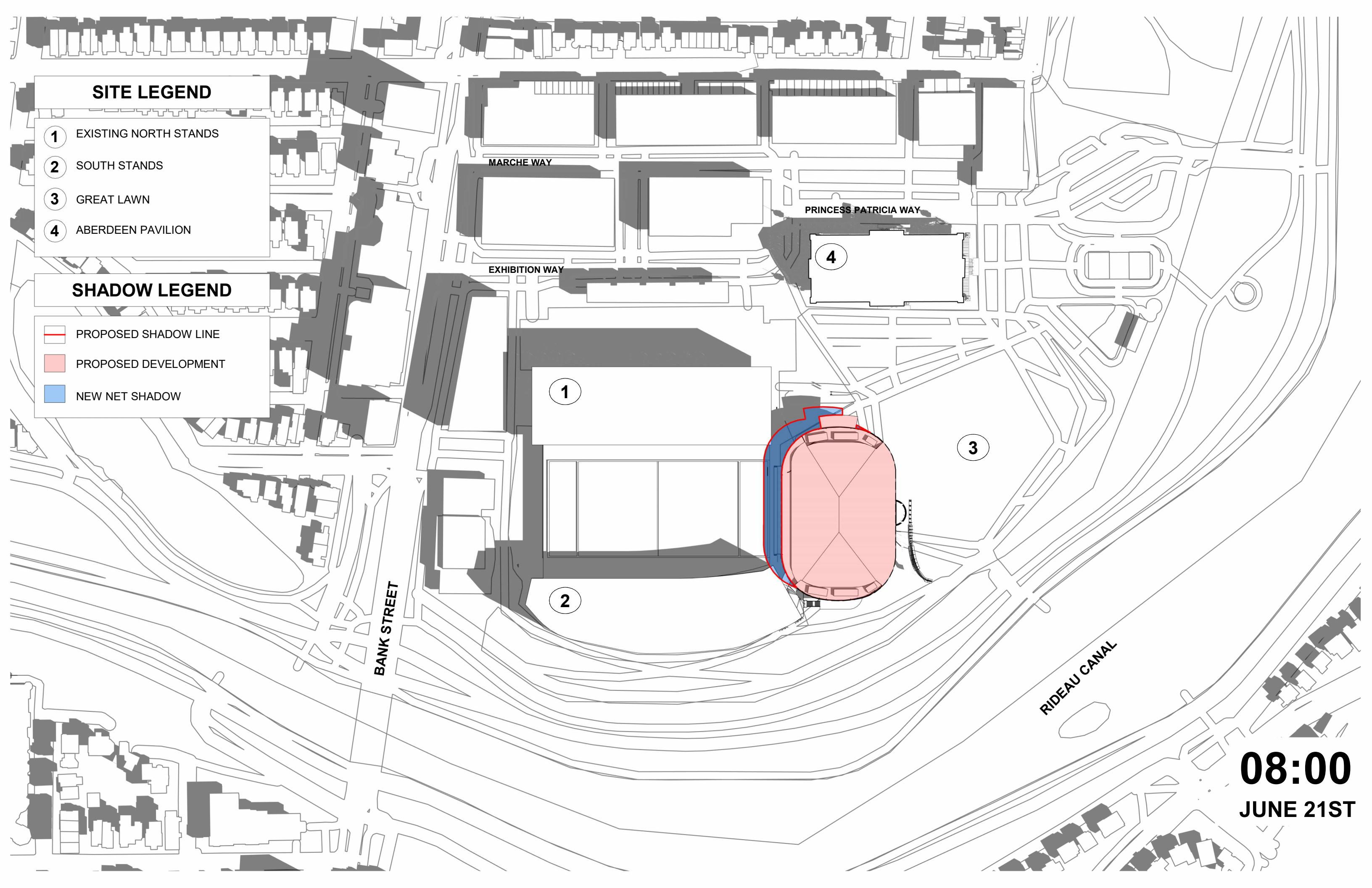

08:00
JUNE 21ST

SITE LEGEND

- 1 EXISTING NORTH STANDS
- 2 SOUTH STANDS
- 3 GREAT LAWN
- 4 ABERDEEN PAVILION

SHADOW LEGEND

- PROPOSED SHADOW LINE
- PROPOSED DEVELOPMENT
- NEW NET SHADOW

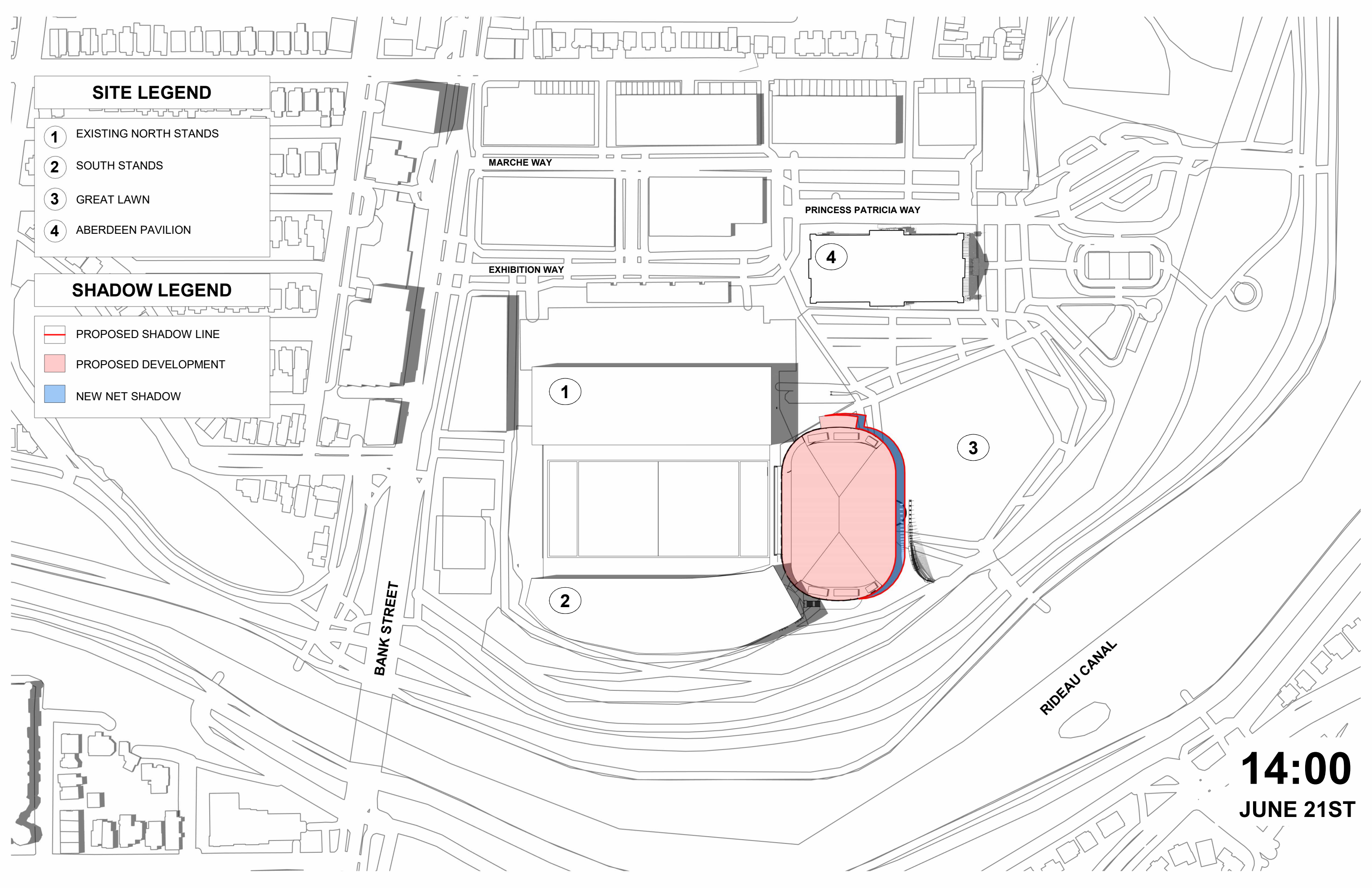

14:00
JUNE 21ST

SITE LEGEND

- 1 EXISTING NORTH STANDS
- 2 SOUTH STANDS
- 3 GREAT LAWN
- 4 ABERDEEN PAVILION

SHADOW LEGEND

- PROPOSED SHADOW LINE
- PROPOSED DEVELOPMENT
- NEW NET SHADOW



20:00
JUNE 21ST

JUNE 21ST

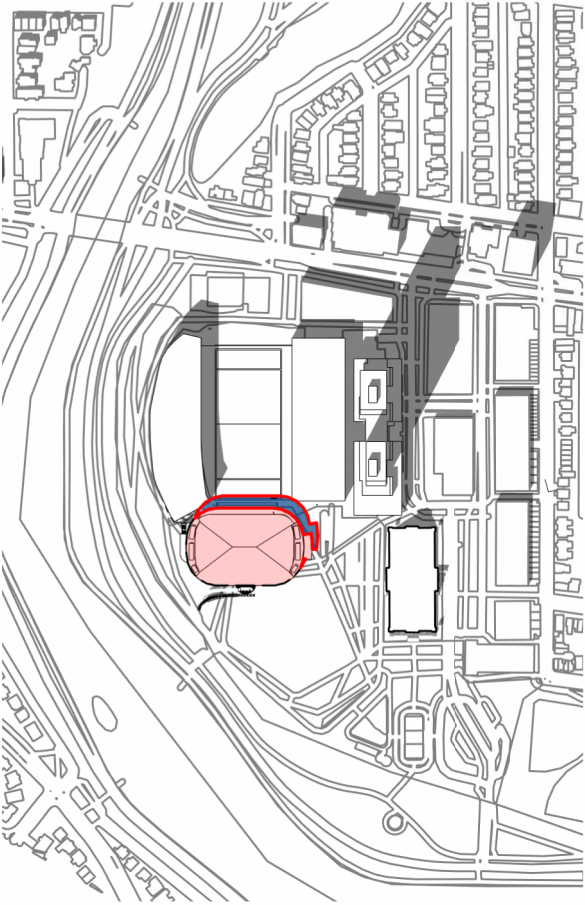

08:00

DEC 21ST



09:00

SEPT 21ST

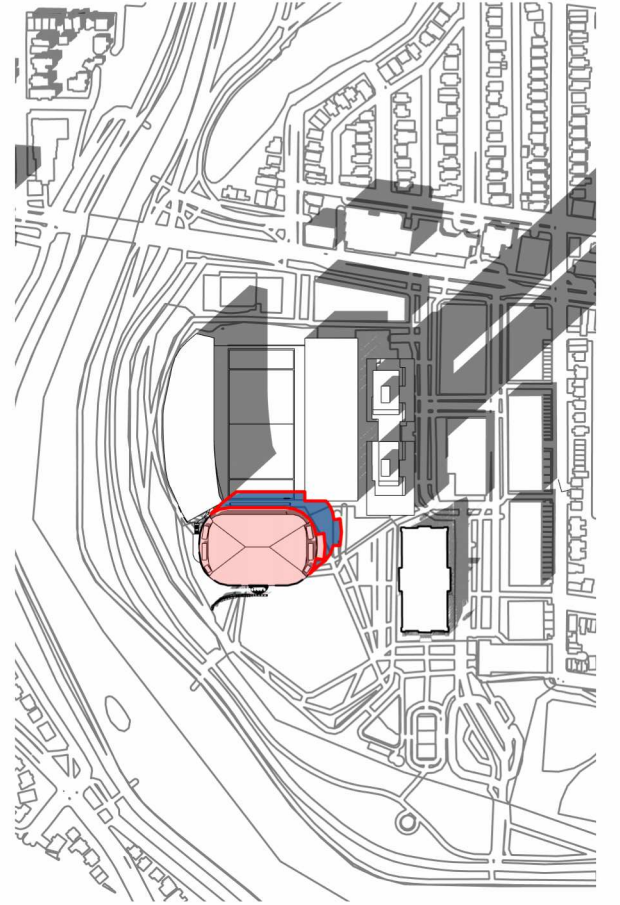

08:00

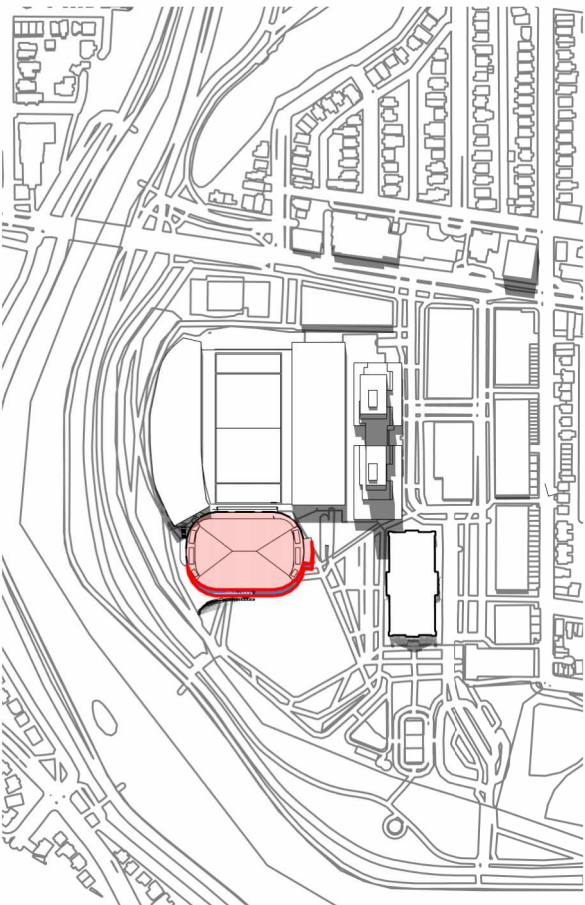

14:00

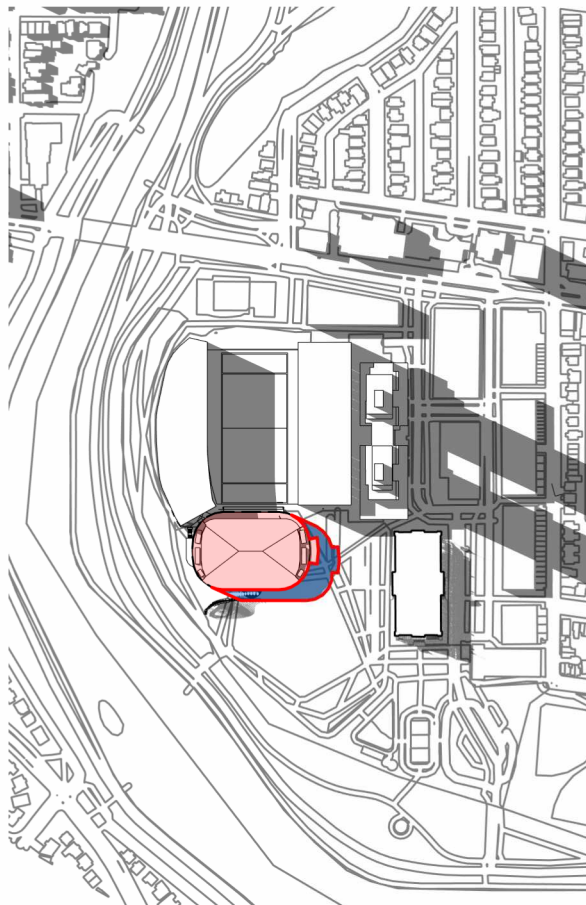

12:00

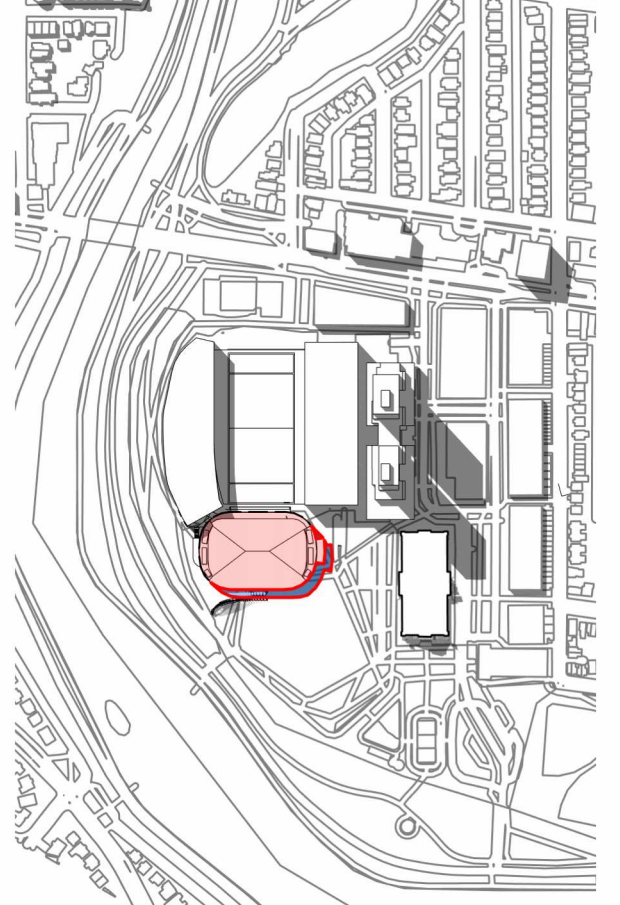

13:00



20:00

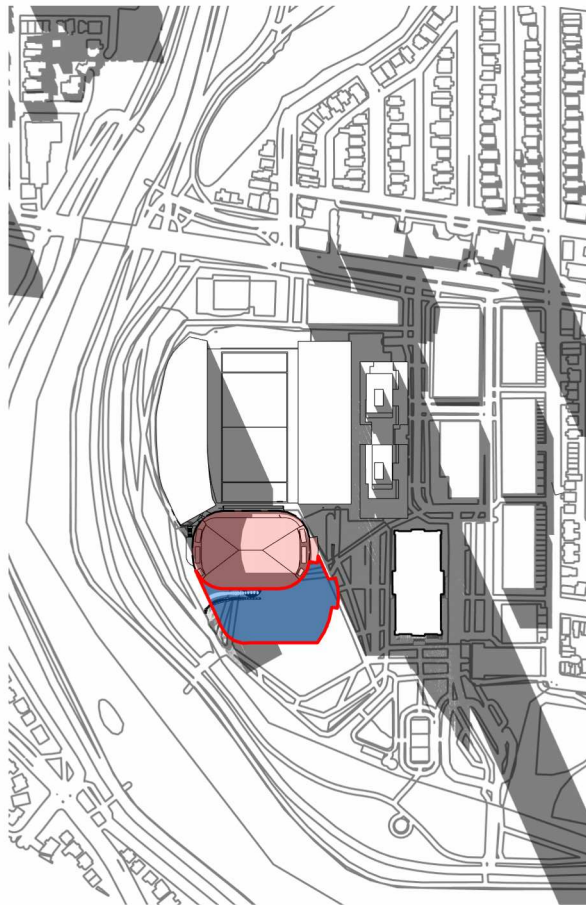

15:00



18:00

**PEDESTRIAN LEVEL
WIND STUDY**

Lansdowne 2.0
Ottawa, Ontario

Report: 23-053-PLW Two Tower Design



September 13, 2023

PREPARED FOR
City of Ottawa
110 Laurier Avenue West
Ottawa, ON K1P 1J1

PREPARED BY
David Huitema, M.Eng., Wind Scientist
Justin Ferraro, P.Eng., Principal

EXECUTIVE SUMMARY

This report describes a pedestrian level wind (PLW) study undertaken to satisfy Zoning By-law Amendment application requirements for the second redevelopment phase of Lansdowne Park, known as Lansdowne 2.0, in Ottawa, Ontario (hereinafter referred to as “subject site” or “proposed development”). Our mandate within this study is to investigate pedestrian wind conditions within and surrounding the subject site, and to identify areas where conditions may interfere with certain pedestrian activities so that mitigation measures may be considered, where required.

The study involves simulation of wind speeds for selected wind directions in a three-dimensional (3D) computer model using the computational fluid dynamics (CFD) technique, combined with meteorological data integration, to assess pedestrian wind comfort and safety within and surrounding the subject site according to City of Ottawa wind comfort and safety criteria. The results and recommendations derived from these considerations are detailed in the main body of the report (Section 5), illustrated in Figures 3A-11D, and summarized as follows:

- 1) Wind conditions in the vicinity of the building access points serving the proposed development and over all grade-level public sidewalks, surface parking, walkways, drop-off areas, the East Court, the Great Lawn, and the walking and bike pathways within Lansdowne Park within and surrounding the subject site are considerable acceptable for the intended pedestrian uses throughout the year.
- 2) Following the introduction of the proposed development, conditions over Aberdeen Square are predicted to be suitable for sitting during the spring, summer, and autumn, becoming suitable for a mix of sitting and standing during the winter. Conditions over the stadium field and the South Court are predicted to be suitable for sitting during the summer, becoming suitable for a mix of sitting and standing throughout the three colder months, while conditions over the existing patios along Exhibition Way are predicted to be suitable for a mix of sitting and standing during the summer and autumn, becoming suitable for standing during the spring and winter with conditions suitable for sitting along the building façades and strolling at the southeast corner of the patios.



- a. Notably, landscaping elements that could not be implemented in the simulation model (such as trees, wooden barriers, or fences) are expected to improve pedestrian comfort around seating areas within the South Court and over the existing patios along Exhibition Way during the colder seasons.
- 3) Wind conditions over the potential patio spaces along the north elevation of the proposed development are predicted to be suitable for sitting during the summer, becoming suitable for standing throughout the remainder of the year, while conditions over the seating areas along the walkway to the new Event Centre along the east elevation of Tower 2 are predicted to be suitable for standing, or better, during the spring, summer, and autumn, and strolling, or better, during the winter.
- a. Targeted wind barriers, which could take the form of wind screens, clusters of coniferous plantings in dense arrangements, or a combination of both options, in combination with canopies above designated seating areas may be implemented to extend sitting conditions over the noted walkway seating areas, as well as over the potential patio spaces if these areas are included by the future retail tenants.
- 4) Areas to the north and at the southeast corner of the new Event Centre are predicted to be suitable for mostly sitting during the summer and autumn, becoming suitable for a mix of sitting and standing during the spring and winter. Conditions over the public promenade are predicted to be suitable for suitable for a mix of sitting and standing during the summer, becoming suitable for strolling, or better, throughout the colder months with a region of conditions suitable for walking to the south of Tower 1 during the winter.
- a. The noted conditions within the public promenade and to the north and southeast of the new Event Centre may be considered acceptable depending on programming. Specifically, if the windier areas within these spaces will not accommodate seating or more sedentary activities, then the noted conditions would be considered acceptable.
 - b. If required by programming, comfort levels around seating areas within the noted windier areas may be improved with the implementation of targeted wind barriers around sensitive areas, which could take the form of wind screens, clusters of coniferous

plantings in dense arrangements, or a combination of both options, in combination with taller perimeter guards in place of standard height guards along perimeters of the promenade.

- c. The extent of the mitigation measures is dependent on the programming of the noted areas. If required by programming, an appropriate mitigation strategy will be developed in collaboration with the building and landscape architects as the design of the development progresses. This work is expected to support the future Site Plan Control application.
- 5) The foregoing statements and conclusions apply to common weather systems, during which no dangerous wind conditions, as defined in Section 4.4, are expected anywhere over the subject site. During extreme weather events, (for example, thunderstorms, tornadoes, and downbursts), pedestrian safety is the main concern. However, these events are generally short-lived and infrequent and there is often sufficient warning for pedestrians to take appropriate cover.

TABLE OF CONTENTS

1. INTRODUCTION 1

2. TERMS OF REFERENCE 1

3. OBJECTIVES 4

4. METHODOLOGY..... 4

4.1 Computer-Based Context Modelling5

4.2 Wind Speed Measurements.....5

4.3 Historical Wind Speed and Direction Data6

4.4 Pedestrian Wind Comfort and Safety Criteria – City of Ottawa.....8

5. RESULTS AND DISCUSSION 10

5.1 Wind Comfort Conditions – Grade Level.....11

5.2 Wind Safety16

5.3 Applicability of Results16

6. CONCLUSIONS AND RECOMMENDATIONS 17

FIGURES

APPENDICES

Appendix A – Simulation of the Atmospheric Boundary Layer



1. INTRODUCTION

Gradient Wind Engineering Inc. (Gradient Wind) was retained by the City of Ottawa to undertake a pedestrian level wind (PLW) study to satisfy Zoning By-Law Amendment (ZBLA) application requirements for the second phase of redevelopment of Lansdowne Park, known as Lansdowne 2.0, in Ottawa, Ontario (hereinafter referred to as “subject site” or “proposed development”). A PLW study considering the previous three-tower design of the Lansdowne 2.0 development was performed in June of 2022¹. Our mandate within this study is to investigate pedestrian wind conditions within and surrounding the subject site, and to identify areas where conditions may interfere with certain pedestrian activities so that mitigation measures may be considered, where required.

Our work is based on industry standard computer simulations using the computational fluid dynamics (CFD) technique and data analysis procedures, City of Ottawa wind comfort and safety criteria, architectural drawings prepared by Hobin Architecture in August 2023, surrounding street layouts and existing and approved future building massing information obtained from the City of Ottawa, as well as recent satellite imagery.

2. TERMS OF REFERENCE

As a result of comments received through public consultant efforts, and City Staff review, as well as an internal evaluation of the development program, the proposed development has been amended as detailed below.

The proposed concept, as outlined in the June 2023 submission, has been revised to remove the third residential tower located closest to the Aberdeen Pavilion, resulting in a two-tower concept of 40 and 25 storeys in height. In addition to the removal of one residential tower, the proposed floorplate sizes of the remaining two towers have been reduced from approximately 900 square metres to approximately 800 square metres.

These two major revisions to the plan have resulted in a decrease in residential unit yield from 1,200 units to approximately 770 units (distributed between the two towers and potential residential podium). The revised design has also allowed for additional tower separation, with an opportunity to now provide

¹ Gradient Wind Engineering Inc., ‘Lansdowne 2.0 – Pedestrian Level Wind Study’, [June 15, 2023]



spacing between towers ranging from 40 to 60 metres, exceeding the distance required in the Zoning By-law and the Urban Design Guidelines for High Rise Buildings. Associated parking for the residential towers has also been reduced from the June 2023 proposal by almost half, decreasing from 739 spaces to 386 spaces. Of the 386 spaces proposed, approximately 35 spaces are allocated to non-residential uses. The remaining parking spaces will be allocated to the two residential towers. No visitor or commercial parking will be provided in the proposed new parking garage, as the existing 1,089 paid underground spaces (including the 230 nested Whole Foods / LCBO spaces) are expected to accommodate those vehicles. A bicycle parking count ratio of one space per unit continues to be proposed.

The retail podium is proposed to be developed as a two-storey built form, consistent with the June 2023 submission. As in the previous submission, the residential portion of the podium will be stepped back from the edge of the retail podium, providing a terrace for the residents of the building. The revised design also results in the podium decreasing in size from approximately 10,003 square metres to approximately 4,611 square metres. This decrease is a result of the removal of the music hall and one upper-level of retail space, which has been replaced by residential amenity area on the second floor of the podium. The reduction in the retail space still allows for an active ground floor that contributes to the year-round activation of Lansdowne.

The removal of the third residential tower adjacent to Aberdeen Pavilion has created an opportunity for the introduction of a new public realm space approximately 1,858 square metres in size. This new public realm space provides an opportunity for activation between the Aberdeen Pavilion and the new Event Centre. Key elements of the proposal such as the ceremonial stairs and raised promenade, as well as views to protected heritage assets are retained in the revised design.

The subject site is bordered by Exhibition Way to the north, the South Court and the Great Lawn to the east, the existing stadium field and the south side stands to the south, and the Rideau at Lansdowne condo development and the existing commercial building at 979 Bank Street to the west. The proposed development comprises the redevelopment of the north side stands (NSS), a new re-designed Event Centre, and two new residential towers, Towers 1 and 2, which rise to 40- and 25-storeys at the west and east, respectively, above a shared four-storey podium along the north elevation of the site. A public promenade is situated to the south of the two towers at Level 2 which provides access to the main concourse of the NSS and is accessed from the grade-level via an outdoor staircase and passageway

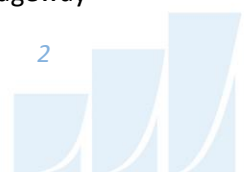

between Towers 1 and 2. A new Event Centre is situated to the east of the stadium field, with an elevated pathway along the west elevation of the Event Centre connecting the NSS to the south side stands. Access to underground parking and loading areas is provided at the east and west elevations of the proposed development. The NSS includes a potential roof over the upper seating levels.

Above an underground parking level, the ground floor of Towers 1 and 2 comprises retail frontage along Exhibition Way, with shared building support spaces along the rear elevation adjoining covered bike parking and loading areas. The residential lobby for Tower 1 is situated to the west, while the residential lobby serving Tower 2 is situated to the east. A ramp down to a truck parking facility is situated to the east of Tower 2. The second level of Towers 1 and 2 comprises commercial space and a residential amenity, respectively, and an outdoor amenity space is situated to the south of Tower 2 at this level. At Level 3, Towers 1 and 2 step back from their north and south elevations, and Levels 3 and 4 of both towers comprises residential units. An outdoor amenity is situated atop the podium between the two towers at Level 5, and the two towers rise above the shared podium with rectangular planforms. Levels 5 and 6 of Tower 1 comprise indoor amenities, while the remaining levels of Tower 1 and Levels 5-25 of Tower 2 comprise residential occupancy. Towers 1 and 2 step back from the west and east elevations at Level 5 and each tower is topped with a mechanical penthouse (MPH).

Level 1 of the NSS includes building operations areas, team spaces, a lower concourse to the west, viewing patios, and an office space to the north. Level 2 of the NSS comprises the main concourse. The NSS stands further include an upper concourse with fan decks overlooking the field, and two upper fan decks to the east and west that overlook the field.

The lower level of the proposed Event Centre comprises building operation and mechanical spaces, building support spaces, and team areas. The main level comprises the concourse level, while the second level includes a sports bar, media spaces, the Loge Club, Stageview Club, and other club spaces and suites.

The near-field surroundings, defined as an area within 200-metres (m) of the subject site include the TD Place field to the south and southeast followed by the existing south side stands, the Rideau at Lansdowne high-rise condo development to the south-southwest and a commercial mid-rise building to the immediate west-southwest followed by a mix of mostly low- and mid-rise massing from the southwest clockwise to the west, low-rise commercial buildings from the west clockwise to the north-northeast, and

the Aberdeen Pavilion and Lansdowne Park from the northeast clockwise to the south-southwest. Beyond Lansdowne Park, the Rideau Canal is situated from the south clockwise to the northeast. The far-field surroundings, defined as an area beyond the near-field but within a 2-kilometre (km) radius of the subject site, are characterized by mostly low-rise massing with clusters of taller mid- and high-rise buildings in all directions, and the southern extent of the urban massing of the downtown core from the north-northeast clockwise to the north. Notably, Carleton University is situated approximately 1.3 km to the southwest and Dow's Lake, the Dominion Arboretum, and the Fletcher Wildlife Garden are located at the west-southwest extent of the far-field.

A site plan for the proposed massing scenario is illustrated in Figure 1A, while the existing massing scenario is illustrated in Figure 1B. Figures 2A-2H illustrate the computational models used to conduct the study. The existing massing scenario includes the existing massing and any future developments approved by the City of Ottawa.

3. OBJECTIVES

The principal objectives of this study are to (i) determine pedestrian level wind conditions at key areas within and surrounding the development site; (ii) identify areas where wind conditions may interfere with the intended uses of outdoor spaces; and (iii) recommend suitable mitigation measures, where required.

4. METHODOLOGY

The approach followed to quantify pedestrian wind conditions over the site is based on CFD simulations of wind speeds across the study site within a virtual environment, meteorological analysis of the Ottawa area wind climate, and synthesis of computational data with City of Ottawa wind comfort and safety criteria². The following sections describe the analysis procedures, including a discussion of the noted pedestrian wind criteria.

² City of Ottawa Terms of References: Wind Analysis
https://documents.ottawa.ca/sites/default/files/torwindanalysis_en.pdf

4.1 Computer-Based Context Modelling

A computer based PLW study was performed to determine the influence of the wind environment on pedestrian comfort over the proposed development site. Pedestrian comfort predictions, based on the mechanical effects of wind, were determined by combining measured wind speed data from CFD simulations with statistical weather data obtained from Ottawa Macdonald-Cartier International Airport. The general concept and approach to CFD modelling is to represent building and topographic details in the immediate vicinity of the study site on the surrounding model, and to create suitable atmospheric wind profiles at the model boundary. The wind profiles are designed to have similar mean and turbulent wind properties consistent with actual site exposures.

An industry standard practice is to omit trees, vegetation, and other existing and planned landscape elements from the model due to the difficulty of providing accurate seasonal representation of vegetation. The omission of trees and other landscaping elements produces slightly stronger wind speeds.

4.2 Wind Speed Measurements

The PLW analysis was performed by simulating wind flows and gathering velocity data over a CFD model of the site for 12 wind directions. The CFD simulation model was centered on the study building, complete with surrounding massing within a radius of 640 m. The process was performed for two context massing scenarios, as noted in Section 2.

Mean and peak wind speed data obtained over the study site for each wind direction were interpolated to 36 wind directions at 10° intervals, representing the full compass azimuth. Measured wind speeds approximately 1.5 m above local grade and the public promenade were referenced to the wind speed at gradient height to generate mean and peak velocity ratios, which were used to calculate full-scale values. Gradient height represents the theoretical depth of the boundary layer of the earth's atmosphere, above which the mean wind speed remains constant. Further details of the wind flow simulation technique are presented in Appendix A.

4.3 Historical Wind Speed and Direction Data

A statistical model for winds in Ottawa was developed from approximately 40 years of hourly meteorological wind data recorded at Ottawa Macdonald-Cartier International Airport and obtained from Environment and Climate Change Canada. Wind speed and direction data were analyzed for each month of the year to determine the statistically prominent wind directions and corresponding speeds, and to characterize similarities between monthly weather patterns.

The statistical model of the Ottawa area wind climate, which indicates the directional character of local winds on a seasonal basis, is illustrated on the following page. The plots illustrate seasonal distribution of measured wind speeds and directions in kilometers per hour (km/h). Probabilities of occurrence of different wind speeds are represented as stacked polar bars in sixteen azimuth divisions. The radial direction represents the percentage of time for various wind speed ranges per wind direction during the measurement period. The prominent wind speeds and directions can be identified by the longer length of the bars. For Ottawa, the most common winds occur for westerly wind directions, followed by those from the east, while the most common wind speeds are below 36 km/h. The directional prominence and relative magnitude of wind speed changes somewhat from season to season.

SEASONAL DISTRIBUTION OF WIND OTTAWA MACDONALD-CARTIER INTERNATIONAL AIRPORT

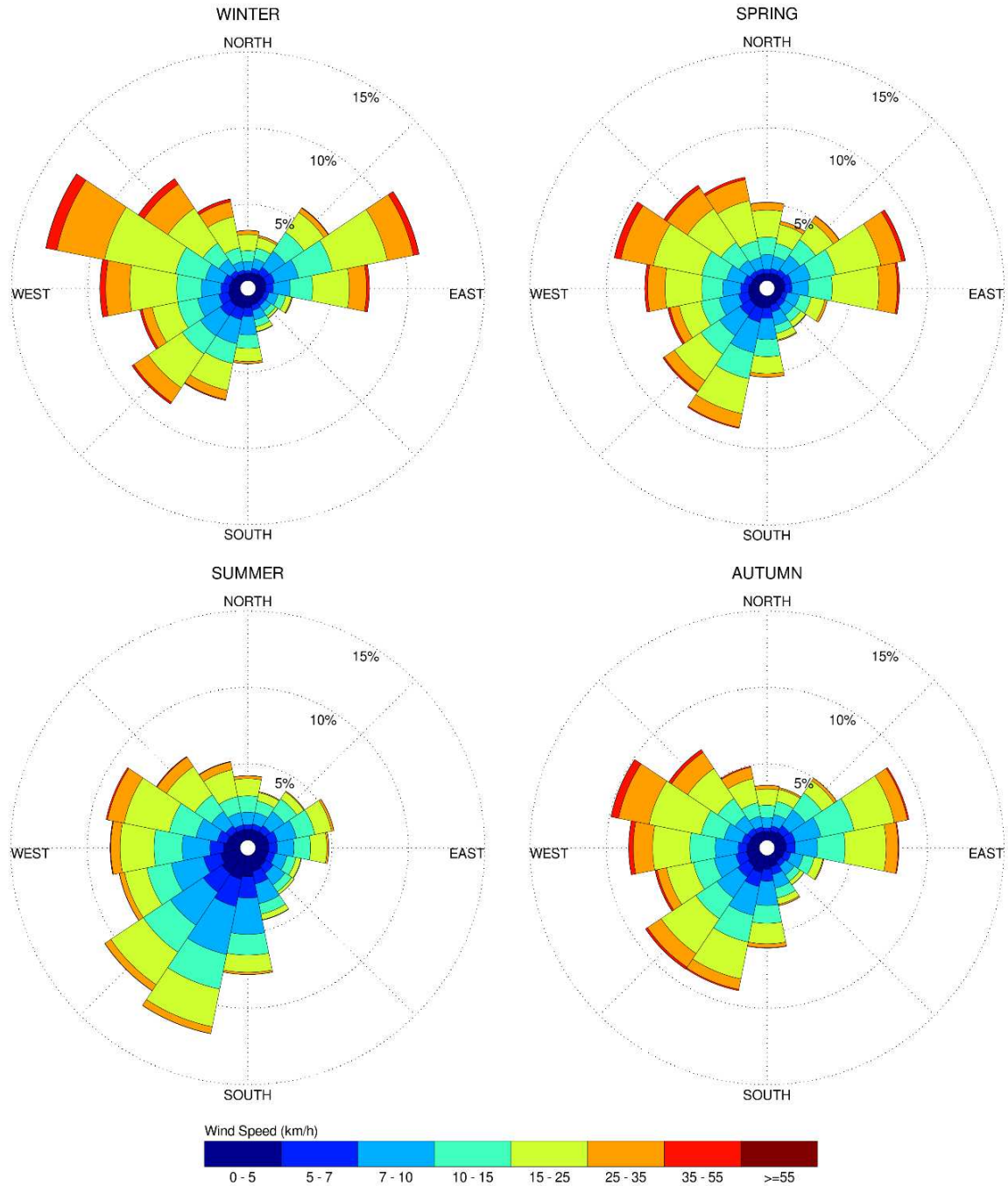





Notes:

1. Radial distances indicate percentage of time of wind events.
2. Wind speeds are mean hourly in km/h, measured at 10 m above the ground.

4.4 Pedestrian Wind Comfort and Safety Criteria – City of Ottawa

Pedestrian wind comfort and safety criteria are based on the mechanical effects of wind without consideration of other meteorological conditions (that is, temperature and relative humidity). The comfort criteria assume that pedestrians are appropriately dressed for a specified outdoor activity during any given season. Five pedestrian comfort classes based on 20% non-exceedance mean wind speed ranges are used to assess pedestrian comfort: (1) Sitting; (2) Standing; (3) Strolling; (4) Walking; and (5) Uncomfortable. The gust speeds, and equivalent mean speeds, are selected based on the Beaufort scale, which describes the effects of forces produced by varying wind speed levels on objects. Wind conditions suitable for sitting are represented by the colour blue, standing by green, strolling by yellow, and walking by orange; uncomfortable conditions are represented by the colour magenta. Specifically, the comfort classes, associated wind speed ranges, and limiting criteria are summarized as follows:

PEDESTRIAN WIND COMFORT CLASS DEFINITIONS

Wind Comfort Class	Mean Speed (km/h)	Description
 Sitting	≤ 10	Mean wind speeds no greater than 10 km/h occurring at least 80% of the time. The equivalent gust wind speed is approximately 16 km/h.
 Standing	≤ 14	Mean wind speeds no greater than 14 km/h occurring at least 80% of the time. The equivalent gust wind speed is approximately 22 km/h.
 Strolling	≤ 17	Mean wind speeds no greater than 17 km/h occurring at least 80% of the time. The equivalent gust wind speed is approximately 27 km/h.
 Walking	≤ 20	Mean wind speeds no greater than 20 km/h occurring at least 80% of the time. The equivalent gust wind speed is approximately 32 km/h.
 Uncomfortable	> 20	Uncomfortable conditions are characterized by predicted values that fall below the 80% target for walking. Brisk walking and exercise, such as jogging, would be acceptable for moderate excesses of this criterion.

Regarding wind safety, the pedestrian safety wind speed criterion is based on the approximate threshold that would cause a vulnerable member of the population to fall. A 0.1% exceedance gust wind speed of 90 km/h is classified as dangerous. From calculations of stability, it can be shown that gust wind speeds of 90 km/h would be the approximate threshold wind speed that would cause an average elderly person in good health to fall. Notably, pedestrians tend to be more sensitive to wind gusts than to steady winds for lower wind speed ranges. For strong winds approaching dangerous levels, this effect is less important because the mean wind can also create problems for pedestrians.

Experience and research on people's perception of mechanical wind effects has shown that if the wind speed levels are exceeded for more than 20% of the time, the activity level would be judged to be uncomfortable by most people. For instance, if a mean wind speed of 10 km/h (equivalent gust wind speed of approximately 16 km/h) were exceeded for more than 20% of the time most pedestrians would judge that location to be too windy for sitting. Similarly, if mean wind speed of 20 km/h (equivalent gust wind speed of approximately 32 km/h) at a location were exceeded for more than 20% of the time, walking or less vigorous activities would be considered uncomfortable. As these criteria are based on subjective reactions of a population to wind forces, their application is partly based on experience and judgment.

Once the pedestrian wind speed predictions have been established throughout the subject site, the assessment of pedestrian comfort involves determining the suitability of the predicted wind conditions for discrete regions within and surrounding the subject site. This step involves comparing the predicted comfort classes to the target comfort classes, which are dictated by the location type for each region (that is, a sidewalk, building entrance, amenity space, or other). An overview of common pedestrian location types and their typical windiest target comfort classes are summarized on the following page. Depending on the programming of a space, the desired comfort class may differ from this table.

TARGET PEDESTRIAN COMFORT CLASSES FOR VARIOUS LOCATION TYPES

Location Types	Comfort Classes
Primary Building Entrance	Standing
Secondary Building Access Point	Walking
Public Sidewalk / Bicycle Path	Walking
Outdoor Amenity Space	Sitting / Standing
Café / Patio / Bench / Garden	Sitting / Standing
Transit Stop (Without Shelter)	Standing
Transit Stop (With Shelter)	Walking
Public Park / Plaza	Sitting / Standing
Garage / Service Entrance	Walking
Parking Lot	Walking
Vehicular Drop-Off Zone	Walking

5. RESULTS AND DISCUSSION

The following discussion of the predicted pedestrian wind conditions for the subject site is accompanied by Figures 3A-10C, illustrating wind conditions at grade level for the proposed and existing massing scenarios, and by Figures 11A-11D, which illustrate wind conditions over the public promenade. Conditions are presented as continuous contours of wind comfort throughout the subject site and correspond to the comfort classes presented in Section 4.4. The details of these conditions are summarized in the following pages for each area of interest.

5.1 Wind Comfort Conditions – Grade Level

Sidewalks along Frank Clair Lane: Following the introduction of the proposed development, wind comfort conditions over the nearby sidewalks along Frank Clair Lane are predicted to be suitable for a mix of sitting and standing during the summer, becoming suitable for strolling, or better, throughout the remainder of the year. The windiest conditions are located along the parking and pedestrian ramps at the west elevation, and near the scoreboard during the winter. The noted conditions are considered acceptable for public sidewalks and walkways.

Conditions along Frank Clair Lane with the existing massing are predicted to be suitable for mostly sitting during the summer, becoming suitable for standing, or better, throughout the remainder of the year, with strolling conditions during the spring and winter predicted beneath the scoreboard. While the introduction of the proposed development is predicted to produce windier conditions along Frank Clair Lane in comparison to existing conditions, wind conditions with the proposed development are nevertheless considered acceptable for the intended pedestrian uses.

West Elevation of the Stadium Field: Following the introduction of the proposed development, wind conditions at the west elevation of the field are predicted to be suitable for sitting during the summer, becoming suitable for a mix of sitting and standing during the spring, autumn, and winter. Conditions over the noted area with the existing massing are predicted to be suitable for sitting during the summer, becoming suitable for sitting to the south and standing to the northwest during the three colder seasons.

Sidewalks, Drop-Off Areas, and Existing Patios along Exhibition Way: Following the introduction of the proposed development, conditions over the public sidewalks and drop-off areas along Exhibition Way are predicted to be suitable for a mix of sitting and standing during the summer, becoming suitable for mostly standing during the autumn, and suitable for a mix of standing and strolling during the spring and winter. The noted conditions are considered acceptable for public sidewalks and drop-off areas.

Wind conditions over the existing restaurant patios along Exhibition way with the proposed massing are predicted to be suitable for a mix of sitting and standing during the summer and autumn. During the spring and winter, conditions over the noted patios are predicted to be suitable for mostly standing with conditions suitable for sitting along the building façades and conditions suitable for strolling at the southeast corner of the patio areas along Exhibition Way. Notably, during the summer season, when



pedestrian usage of public and private seating areas is expected to be the most frequent and when pedestrians may linger in the area, conditions with the proposed development over the noted areas are mostly suitable for sitting, with limited standing conditions along Exhibition Way that are mostly located over the adjoining sidewalks and roadway. Additionally, the noted moderately windier conditions suitable for strolling during the spring and winter are mostly limited to over the nearby roadways and public sidewalks. Landscaping elements that could not be implemented into the wind model (such as trees and wooden barriers or fences), as described in Section 4.1, are expected to somewhat improve pedestrian comfort over the noted patios or seating areas.

Conditions along Exhibition Way with the existing massing are predicted to be mostly suitable for sitting during the spring, summer, and autumn, becoming suitable for standing, or better, during the winter season, while conditions over the noted existing patios are predicted to be suitable for sitting throughout the year.

Potential Patio Spaces: Wind conditions over the potential patio spaces along the north elevation of the proposed development are predicted to be suitable for sitting during the summer, becoming suitable for standing throughout the remainder of the year. If these patio spaces are included by the future retail tenants of the Lansdowne 2.0 development, comfort levels may be improved with the implementation of targeted wind barriers around seating areas, which could take the form of wind screens, clusters of coniferous plantings in dense arrangements, or a combination of both options, in combination with canopies above designated seating areas.

Sidewalks along Paul Askin Way: Following the introduction of the proposed development, conditions over the public sidewalks along Paul Askin Way are predicted to be suitable for sitting during the summer, becoming suitable for a mix of sitting and standing during the remaining seasons. The noted conditions are considered acceptable.

Conditions over the sidewalks along Paul Askin Way with the existing massing are predicted to be mostly suitable for sitting throughout the year. While the introduction of the proposed development is predicted to produce windier conditions along Paul Askin Way in comparison to existing conditions, wind conditions with the proposed development are nevertheless considered acceptable for the intended pedestrian uses.



Aberdeen Square: Following the introduction of the proposed development, wind comfort conditions within Aberdeen Square are predicted to be suitable for sitting during the spring, summer, and autumn, becoming suitable for a mix of sitting and standing and during the winter. Wind conditions over Aberdeen Square with the existing massing are predicted to be suitable for sitting throughout the year.

South Court: Following the introduction of the proposed development, wind conditions over the South Court are predicted to be suitable for mostly sitting during the summer, becoming suitable for a mix of mostly sitting and standing throughout the remainder of the year. With the existing massing, wind conditions over the South Court are predicted to be suitable for sitting during the summer, suitable for sitting during the autumn with standing conditions to the east of the South Court, and suitable for standing to the east and west and sitting elsewhere within the court during the spring and winter. Notably, landscaping elements that could not be implemented in the simulation model (that is, dense plantings and trees), as described in Section 4.1, are expected to improve pedestrian comfort around seating areas within the South Court during the colder seasons.

East Court: Prior to the introduction of the proposed development, wind conditions over the East Court are predicted to be calm and suitable for mostly sitting throughout the year. These conditions remain mostly unchanged following the introduction of the proposed development and are considered acceptable.

Walkway North of the New Event Centre: Wind conditions over the proposed walkway to the east of Tower 2 that connects the Aberdeen Pavilion to the proposed Event Centre are predicted to be suitable for a mix of sitting and standing during the spring, summer, and autumn, becoming suitable for a mix of sitting, standing, and strolling during the winter. The noted conditions are considered acceptable for public walkways and pathways.

Wind conditions over the seating areas along the noted walkways are predicted to be suitable for mostly sitting during the summer, becoming suitable for standing, or better, during the spring and autumn, and strolling, or better, during the winter. If required by programming, sitting conditions may be extended over the noted areas by implementing targeted wind barriers in the form of wind screens and coniferous plantings around designated seating areas.



New Event Centre Public Areas: Wind conditions to the north and at the southeast corner of the proposed Event Centre are predicted to be suitable for mostly sitting during the summer and autumn, becoming suitable for a mix of sitting and standing during the spring and winter. Where conditions are suitable for standing, they are also suitable for sitting for at least 75% of the time during the spring and at least 70% of the time during the winter, where the target is 80% to achieve the sitting comfort class.

Depending on the programming of these areas, conditions within the noted areas may be considered acceptable. Specifically, if the windier areas within the noted spaces will not accommodate seating or more sedentary activities, then the conditions would be considered acceptable. If required by programming, comfort levels may be improved with the implementation of targeted wind barriers around sensitive areas, which could take the form of wind screens, clusters of coniferous trees in dense arrangements, or a combination of both options.

Great Lawn: Following the introduction of the proposed development, conditions during the summer over the Great Lawn are predicted to be suitable for sitting, becoming suitable for a mix of sitting and standing during the autumn. Conditions are predicted to be suitable for mostly standing during the spring and winter. Prior to the introduction of the proposed development, wind conditions over the Great Lawn are predicted to be suitable for sitting during the summer, becoming suitable for standing to the east and sitting to the west during the spring, autumn, and winter. While the introduction of the proposed development produces windier conditions over the Great Lawn, wind conditions with the proposed development remain mostly similar to those under the existing massing during the primary use seasons of spring, summer, and autumn, and furthermore, the Great Lawn has limited seating areas. As such, conditions over the Great Lawn with the proposed development are considered acceptable.

Nearby Lansdowne Park Pathways to the South and East of the New Event Centre: Prior to the introduction of the proposed development, wind comfort conditions over the nearby existing pathways within Lansdowne Park to the south and east of the new Event Centre are predicted to be suitable for sitting during the summer, becoming suitable for standing, or better, throughout the remainder of the year. Wind conditions following the introduction of the proposed development are predicted to be similar over the noted pathways. The noted conditions are considered acceptable for public pathways and bicycle paths.

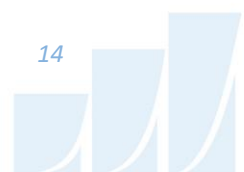

Stadium Field: Under the existing massing, wind conditions over the stadium field are predicted to be suitable for sitting during the summer and autumn. During the spring, the east end of the field is predicted to have conditions suitable for standing, while the remainder of the field is suitable for sitting, and during the winter season when the use of the field is limited, the standing conditions extend to the middle of the field. With the proposed development, conditions over the field are predicted to be suitable for sitting during the summer, becoming suitable for a mix of sitting and standing during the three colder seasons. The majority of the field is predicted to be suitable for standing during the spring and winter, with sitting conditions predicted at the west end of the field and over the eastern portion of the east end zone.

Laneway, Bike Storage, and Loading Areas to the South of Towers 1 and 2: Wind conditions over the covered bike storage and loading areas beneath the public promenade and over the laneway along the west elevation of Tower 1 are predicted suitable for standing, or better, during the summer, becoming suitable for strolling, or better, during the remainder of the year. The noted conditions are considered acceptable.

Public Promenade and Ceremonial Stair: As illustrated in Figures 11A-11D, wind comfort conditions over the ceremonial stair and passageway leading to the public promenade are predicted to be suitable for sitting during the summer, becoming suitable for standing, or better, during the spring, autumn, and winter. The noted conditions are considered acceptable for public walkways.

Conditions over the public promenade during the summer are predicted to be suitable for a mix of sitting and standing during the summer, becoming suitable for strolling, or better, during the spring, autumn, and winter, with an area of conditions suitable for walking during the winter to the west of the public promenade.

The noted conditions within the public promenade may be considered acceptable depending on programming. Specifically, if the windier areas of the promenade will not accommodate seating or more sedentary activities, then the noted conditions would be considered acceptable. If required by programming, comfort levels around sensitive areas may be improved by implementing taller perimeter guards in place of standard height guards along the perimeters of the promenade, in combination with wind barriers or canopies located around sensitive areas.

The extent of the mitigation measures is dependent on the programming of the promenade. If required by programming, an appropriate mitigation strategy will be developed in collaboration with the building and landscape architects as the design of the development progresses. This work is expected to support the future Site Plan Control application.

Building Access Points: Owing to the protection of the building façades, conditions in the vicinity of the building access points serving the proposed development are predicted to be suitable for standing, or better, throughout the year. The noted conditions are considered acceptable.

5.2 Wind Safety

Within the context of typical weather patterns, which exclude anomalous localized storm events such as tornadoes and downbursts, no pedestrian areas within or surrounding the subject site are expected to experience conditions that could be considered dangerous, as defined in Section 4.4.

5.3 Applicability of Results

Pedestrian wind comfort and safety have been quantified for the specific configuration of existing and foreseeable construction around the subject site. Future changes (that is, construction or demolition) of these surroundings may cause changes to the wind effects in two ways, namely: (i) changes beyond the immediate vicinity of the subject site would alter the wind profile approaching the subject site; and (ii) development in proximity to the subject site would cause changes to local flow patterns.

6. CONCLUSIONS AND RECOMMENDATIONS

A complete summary of the predicted wind conditions is provided in Section 5 and illustrated in Figures 3A-11D. Based on computer simulations using the CFD technique, meteorological data analysis of the Ottawa wind climate, City of Ottawa wind comfort and safety criteria, and experience with numerous similar developments, the study concludes the following:

- 1) Wind conditions in the vicinity of the building access points serving the proposed development and over all grade-level public sidewalks, surface parking, walkways, drop-off areas, the East Court, the Great Lawn, and the walking and bike pathways within Lansdowne Park within and surrounding the subject site are considerable acceptable for the intended pedestrian uses throughout the year.
- 2) Following the introduction of the proposed development, conditions over Aberdeen Square are predicted to be suitable for sitting during the spring, summer, and autumn, becoming suitable for a mix of sitting and standing during the winter. Conditions over the stadium field and the South Court are predicted to be suitable for sitting during the summer, becoming suitable for a mix of sitting and standing throughout the three colder months, while conditions over the existing patios along Exhibition Way are predicted to be suitable for a mix of sitting and standing during the summer and autumn, becoming suitable for standing during the spring and winter with conditions suitable for sitting along the building façades and strolling at the southeast corner of the patios.
 - a. Notably, landscaping elements that could not be implemented in the simulation model (such as trees, wooden barriers, or fences) are expected to improve pedestrian comfort around seating areas within the South Court and over the existing patios along Exhibition Way during the colder seasons.
- 3) Wind conditions over the potential patio spaces along the north elevation of the proposed development are predicted to be suitable for sitting during the summer, becoming suitable for standing throughout the remainder of the year, while conditions over the seating areas along the walkway to the new Event Centre along the east elevation of Tower 2 are predicted to be suitable for standing, or better, during the spring, summer, and autumn, and strolling, or better, during the winter.

- a. Targeted wind barriers, which could take the form of wind screens, clusters of coniferous plantings in dense arrangements, or a combination of both options, in combination with canopies above designated seating areas may be implemented to extend sitting conditions over the noted walkway seating areas, as well as over the potential patio spaces if these areas are included by the future retail tenants.
- 4) Areas to the north and at the southeast corner of the new Event Centre are predicted to be suitable for mostly sitting during the summer and autumn, becoming suitable for a mix of sitting and standing during the spring and winter. Conditions over the public promenade are predicted to be suitable for suitable for a mix of sitting and standing during the summer, becoming suitable for strolling, or better, throughout the colder months with a region of conditions suitable for walking to the south of Tower 1 during the winter.
- a. The noted conditions within the public promenade and to the north and southeast of the new Event Centre may be considered acceptable depending on programming. Specifically, if the windier areas within these spaces will not accommodate seating or more sedentary activities, then the noted conditions would be considered acceptable.
 - b. If required by programming, comfort levels around seating areas within the noted windier areas may be improved with the implementation of targeted wind barriers around sensitive areas, which could take the form of wind screens, clusters of coniferous plantings in dense arrangements, or a combination of both options, in combination with taller perimeter guards in place of standard height guards along perimeters of the promenade.
 - c. The extent of the mitigation measures is dependent on the programming of the noted areas. If required by programming, an appropriate mitigation strategy will be developed in collaboration with the building and landscape architects as the design of the development progresses. This work is expected to support the future Site Plan Control application.



- 5) The foregoing statements and conclusions apply to common weather systems, during which no dangerous wind conditions, as defined in Section 4.4, are expected anywhere over the subject site. During extreme weather events, (for example, thunderstorms, tornadoes, and downbursts), pedestrian safety is the main concern. However, these events are generally short-lived and infrequent and there is often sufficient warning for pedestrians to take appropriate cover.

Sincerely,

Gradient Wind Engineering Inc.



David Huitema, M.Eng.
Wind Scientist



Justin Ferraro, P.Eng.
Principal

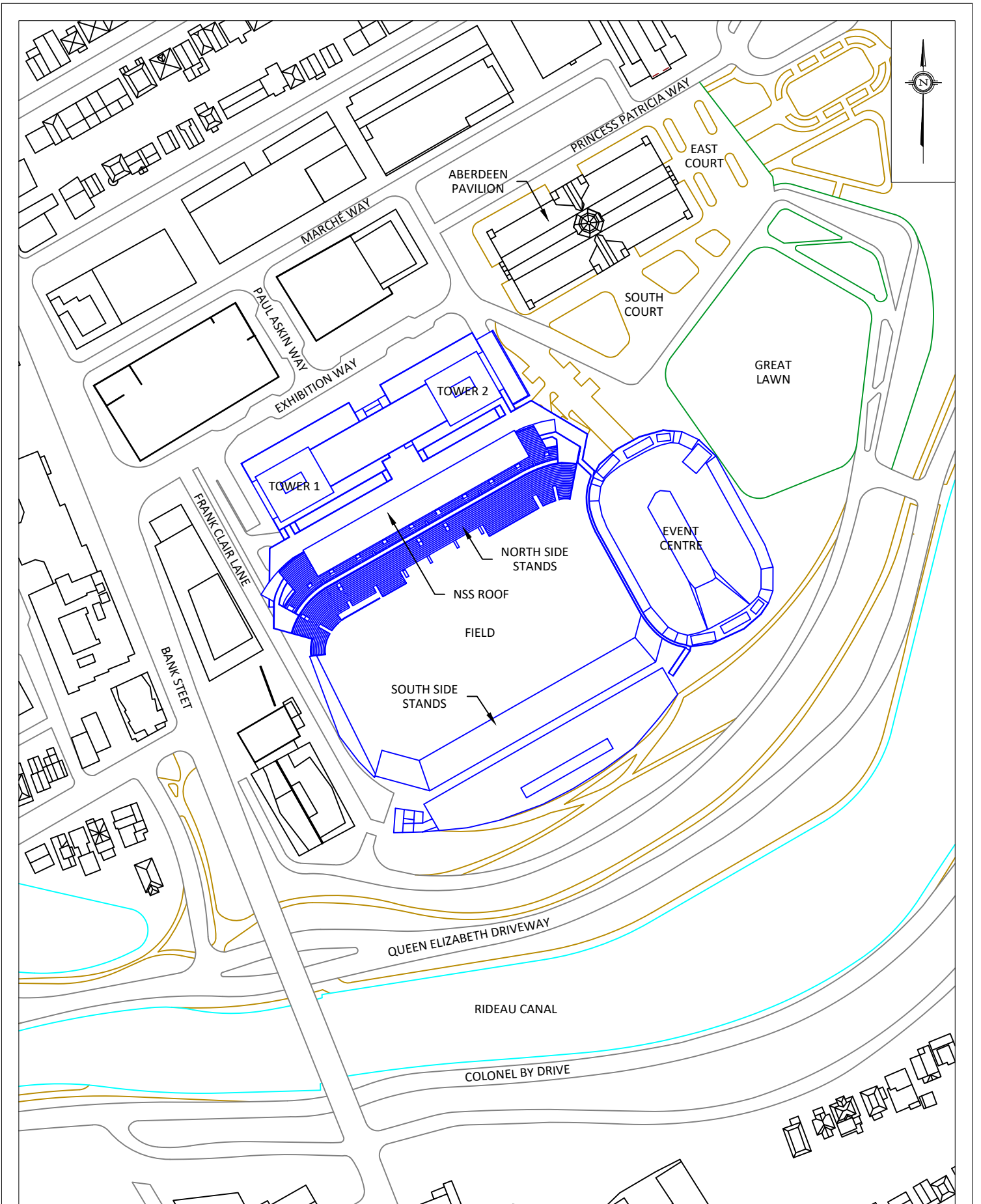

GRADIENTWIND

ENGINEERS & SCIENTISTS

127 WALGREEN ROAD, OTTAWA, ON
613 836 0934 • GRADIENTWIND.COM

PROJECT

LANSDOWNE 2.0, OTTAWA
PEDESTRIAN LEVEL WIND STUDY

SCALE

1:2000

DRAWING NO.

23-053-PLW-1A

DATE

AUGUST 31, 2023

DRAWN BY

T.K.

DESCRIPTION

FIGURE 1A:
PROPOSED SITE PLAN AND SURROUNDING CONTEXT
WITH NORTH SIDE STANDS ROOF

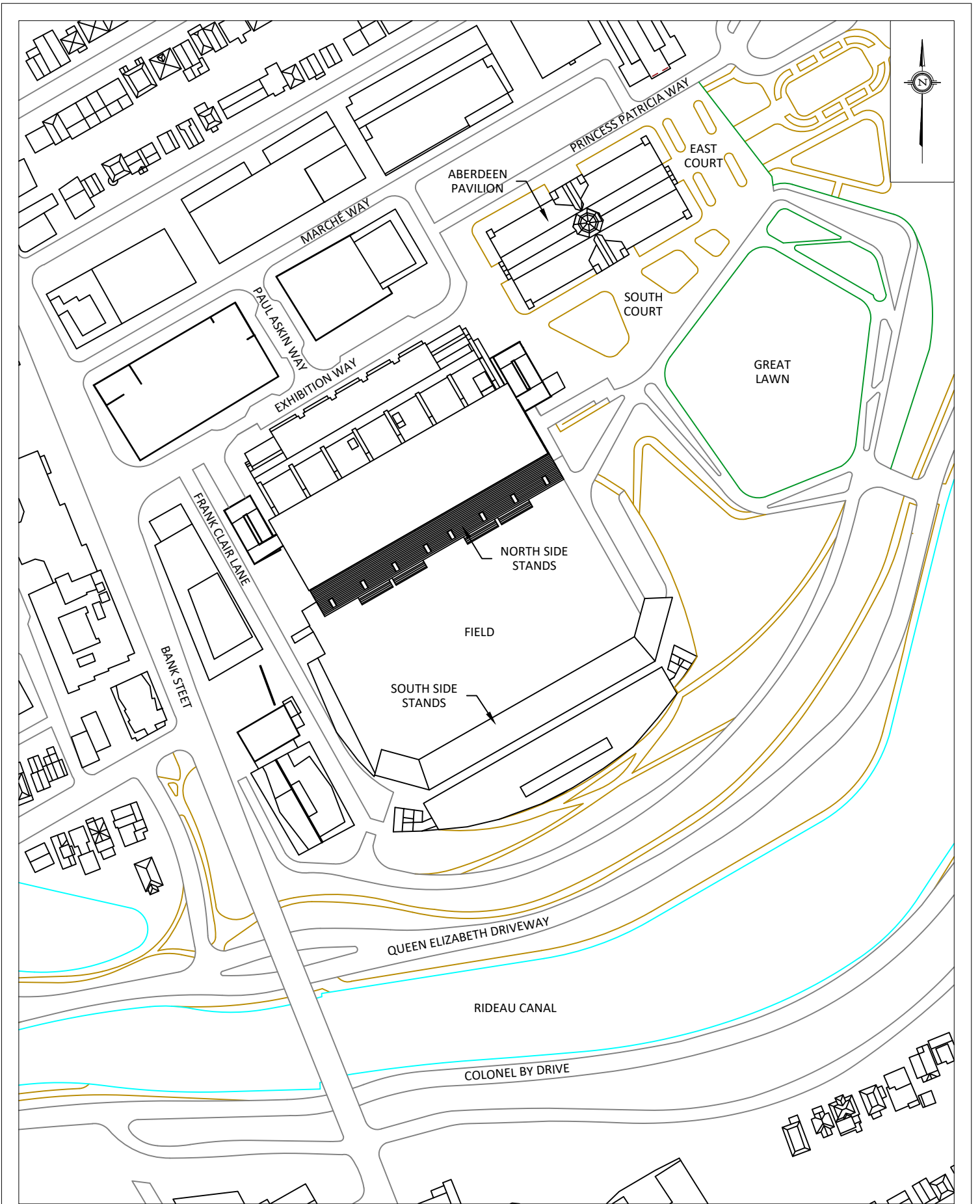

GRADIENTWIND

ENGINEERS & SCIENTISTS

127 WALGREEN ROAD, OTTAWA, ON
613 836 0934 • GRADIENTWIND.COM

PROJECT

LANSDOWNE 2.0, OTTAWA
PEDESTRIAN LEVEL WIND STUDY

SCALE

1:2000

DRAWING NO.

23-053-PLW-1B

DATE

AUGUST 31, 2023

DRAWN BY

T.K.

DESCRIPTION

FIGURE 1B:
EXISTING SITE PLAN AND SURROUNDING CONTEXT

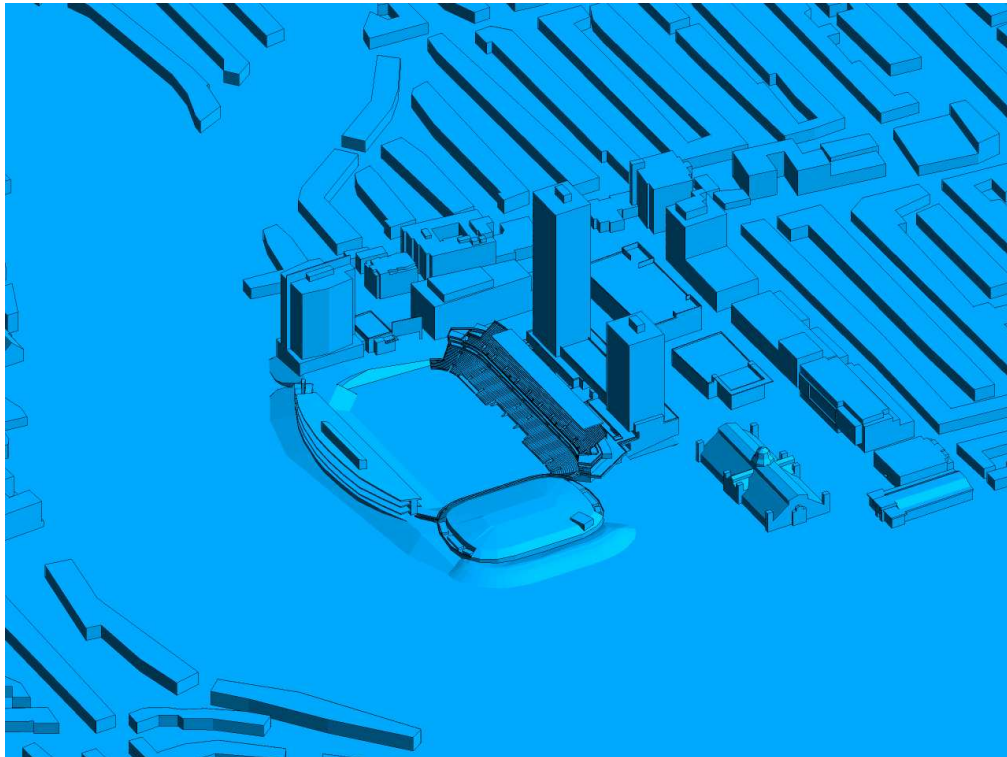

FIGURE 2A: COMPUTATIONAL MODEL, PROPOSED MASSING, EAST VIEW

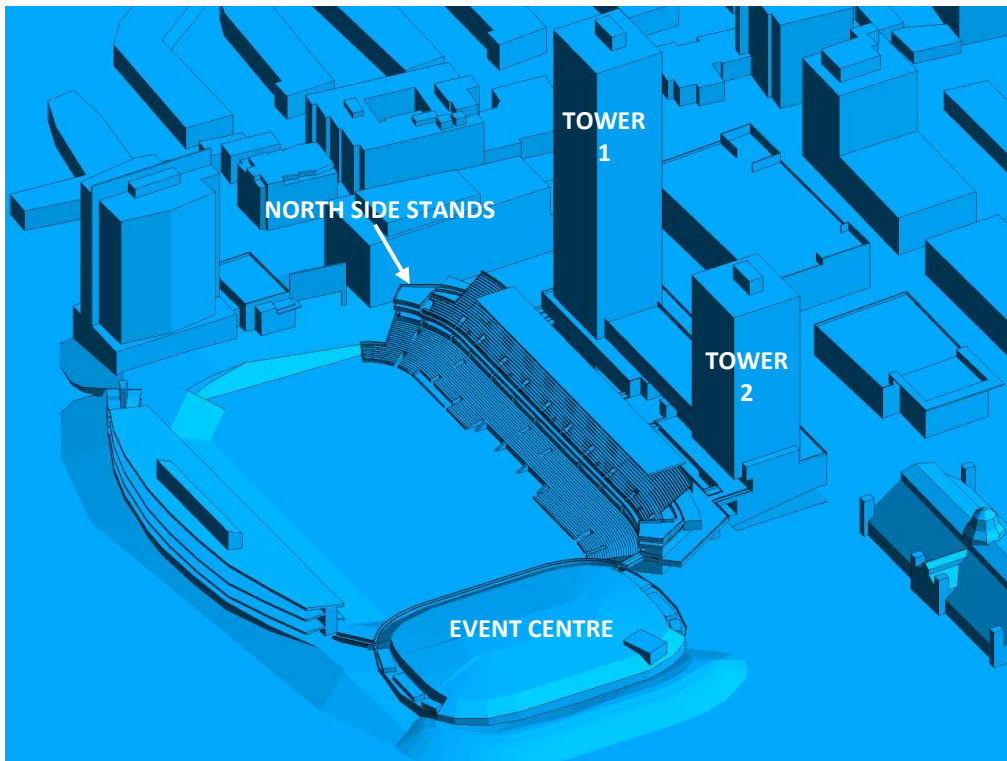

FIGURE 2B: CLOSE UP OF FIGURE 2A



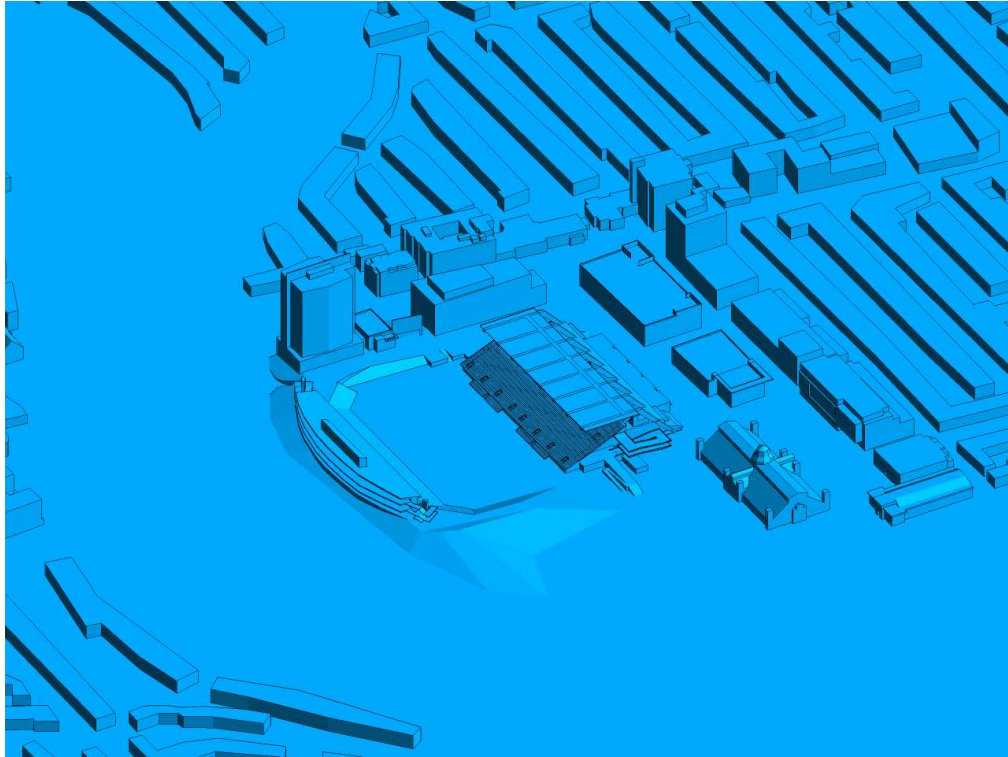

FIGURE 2C: COMPUTATIONAL MODEL, EXISTING MASSING, EAST VIEW

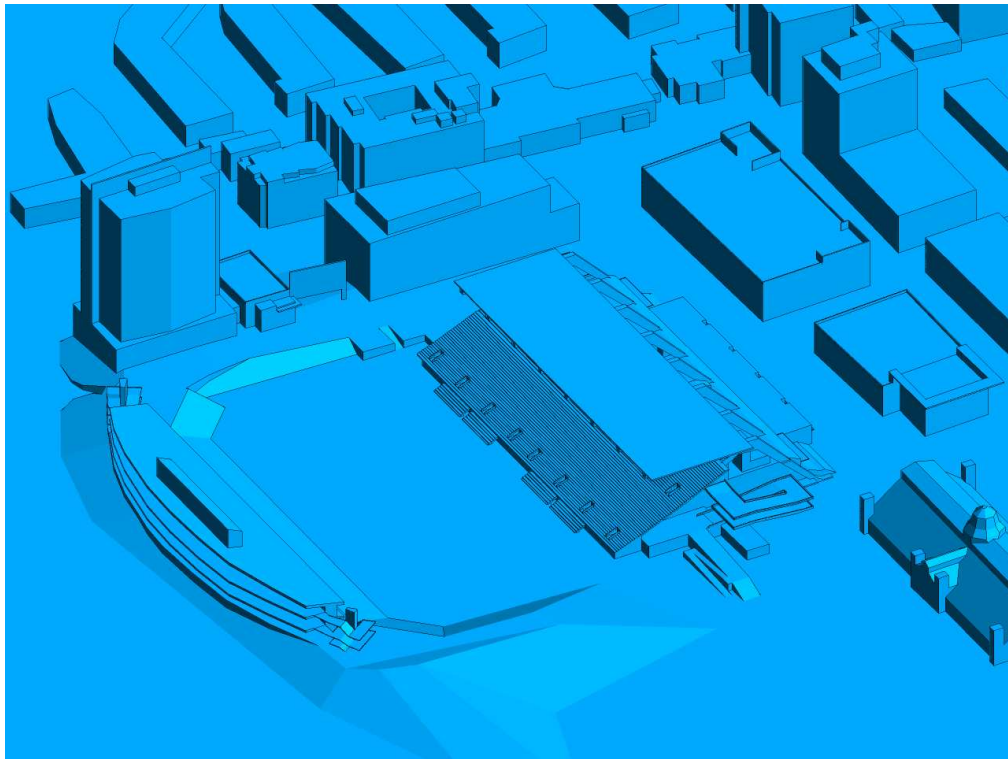

FIGURE 2D: CLOSE UP OF FIGURE 2C



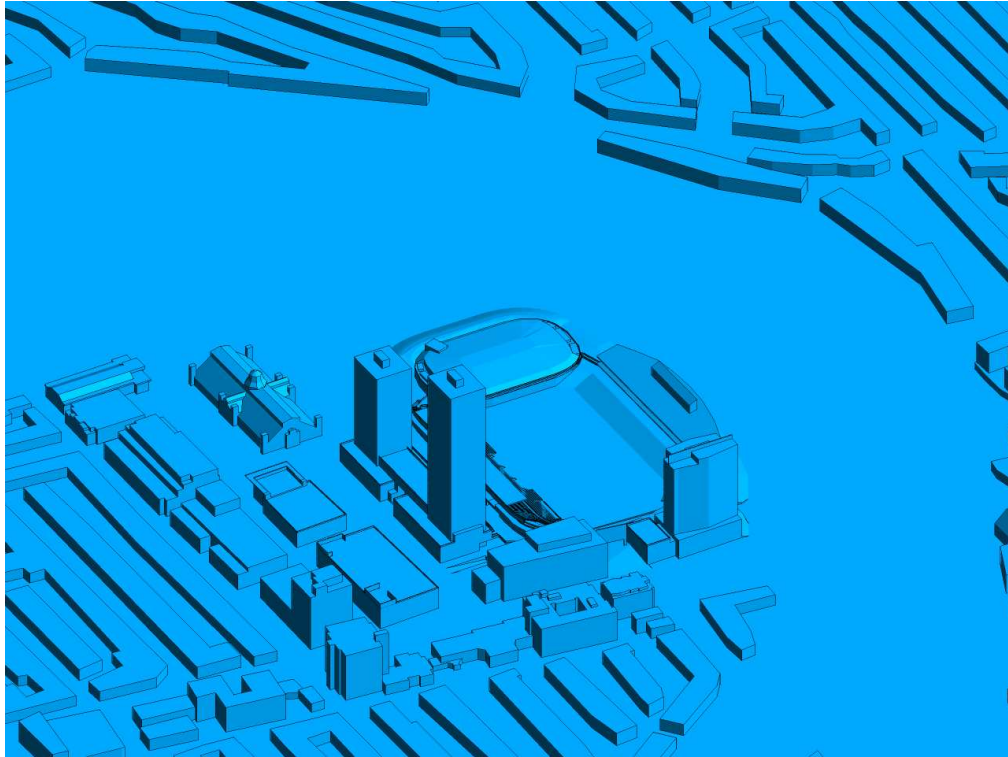

FIGURE 2E: COMPUTATIONAL MODEL, PROPOSED MASSING, WEST VIEW

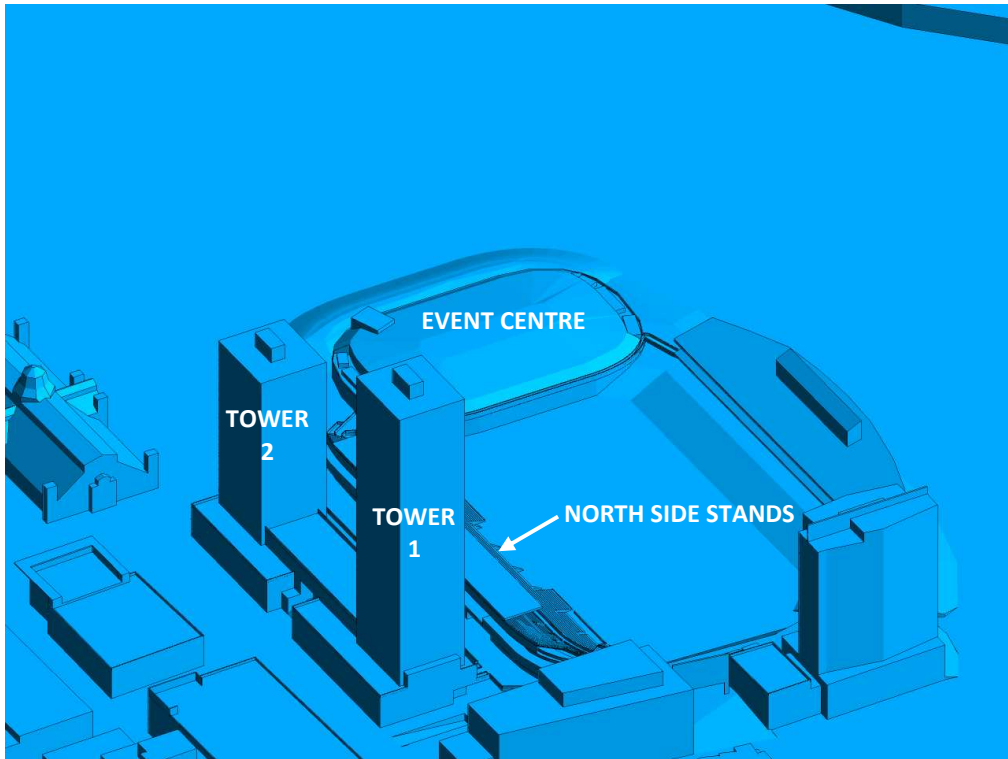

FIGURE 2F: CLOSE UP OF FIGURE 2E



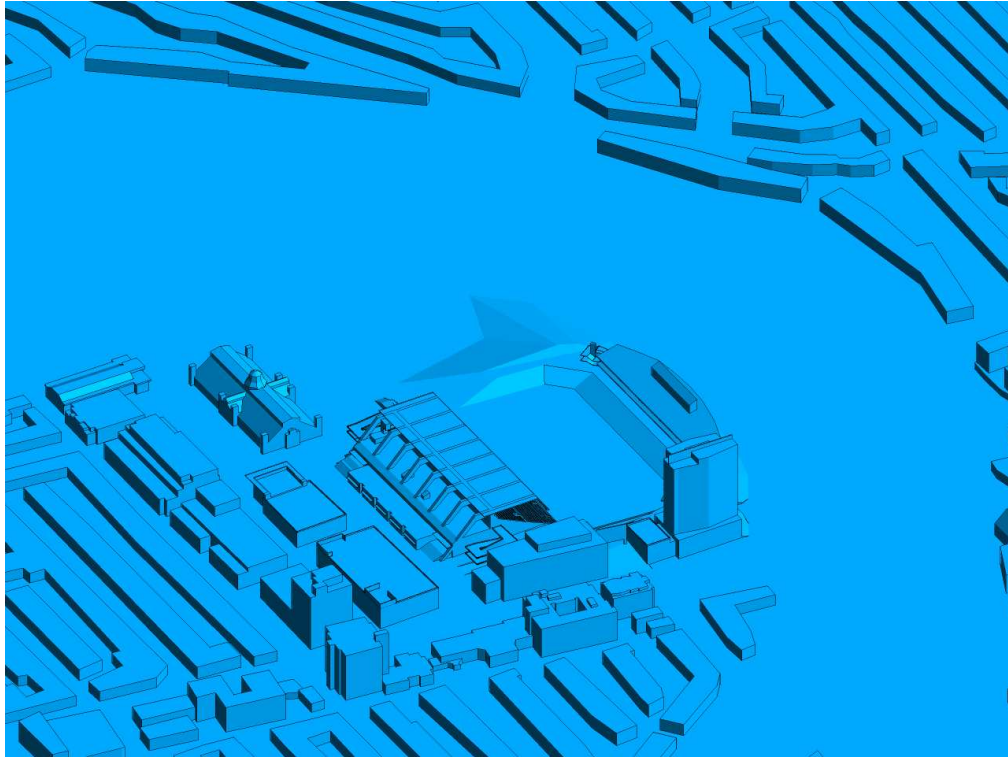

FIGURE 2G: COMPUTATIONAL MODEL, EXISTING MASSING, WEST PERSPECTIVE

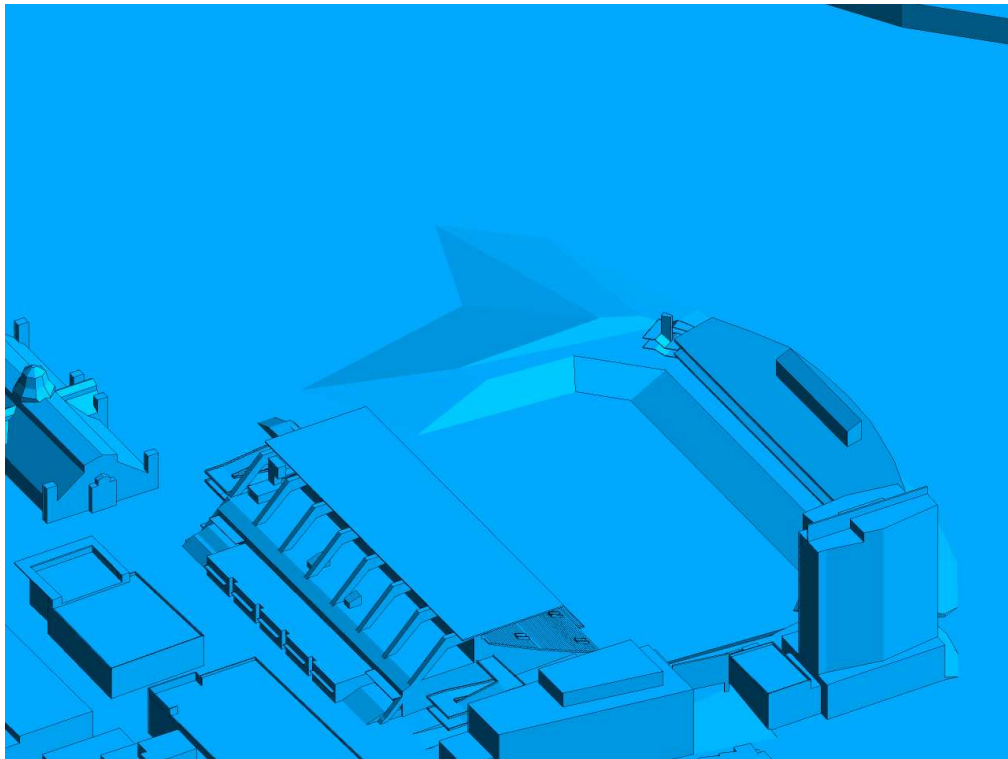

FIGURE 2H: CLOSE UP OF FIGURE 2G



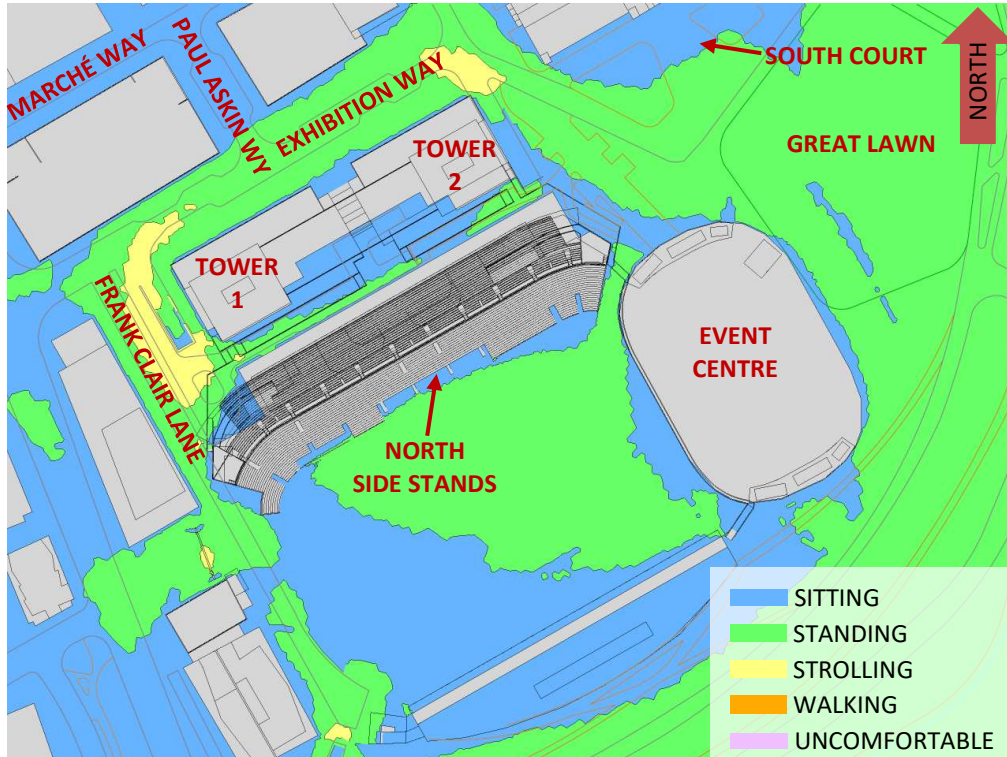

FIGURE 3A: SPRING – WIND COMFORT, TD PLACE – PROPOSED

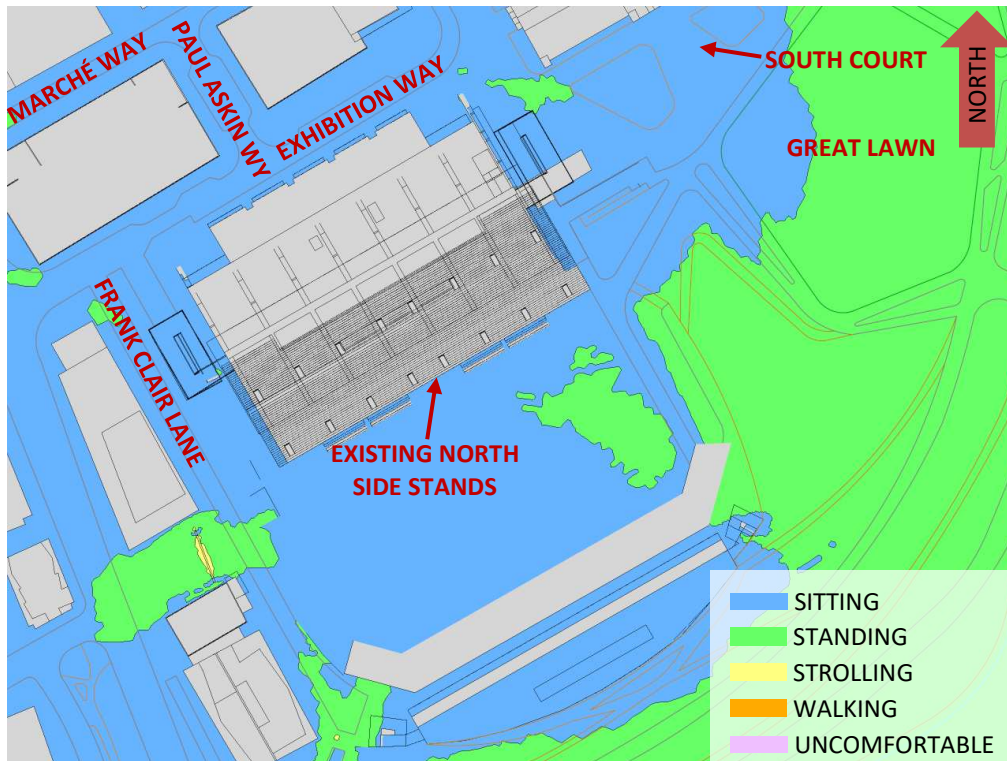

FIGURE 3B: SPRING – WIND COMFORT, TD PLACE – EXISTING



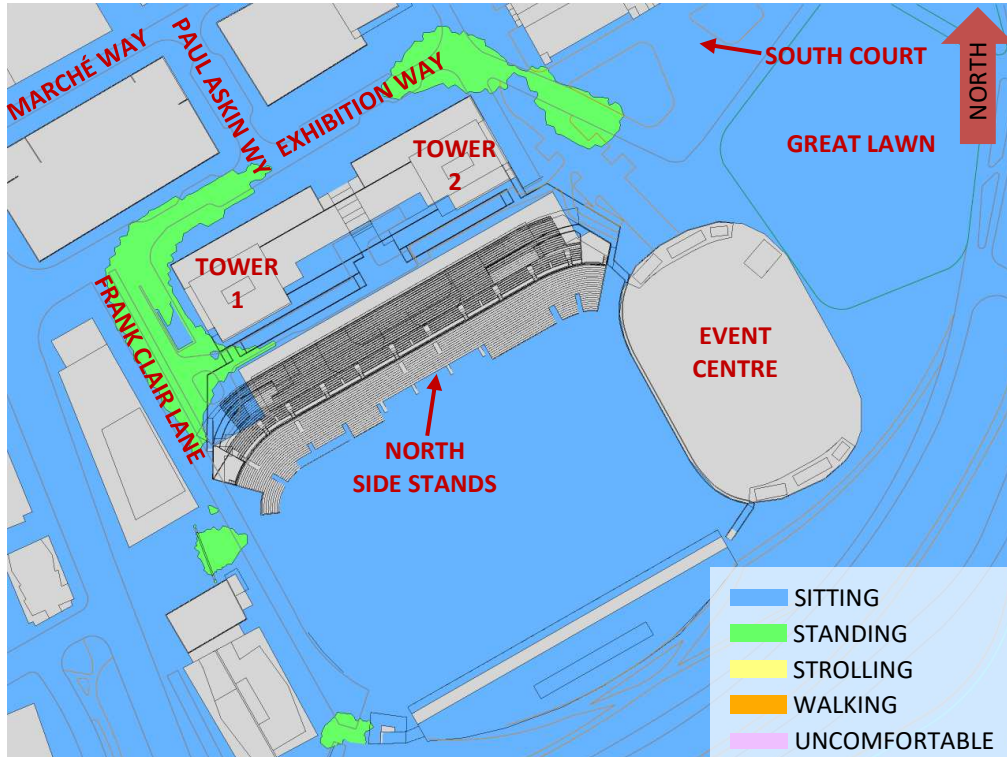

FIGURE 4A: SUMMER – WIND COMFORT, TD PLACE – PROPOSED

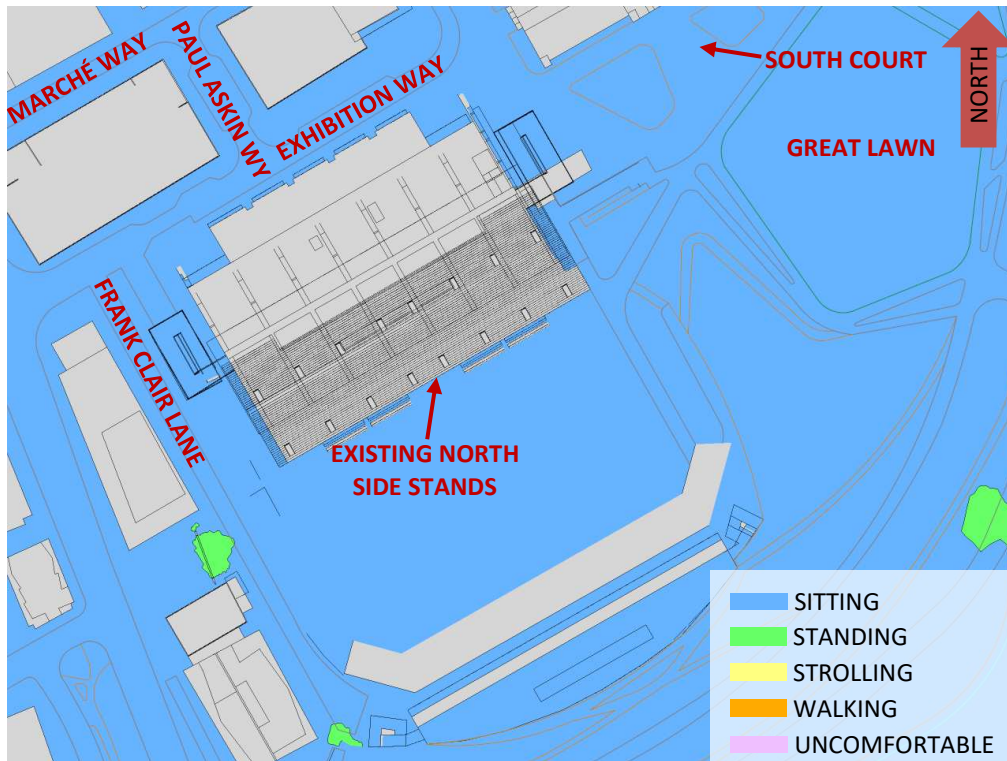

FIGURE 4B: SUMMER – WIND COMFORT, TD PLACE – EXISTING



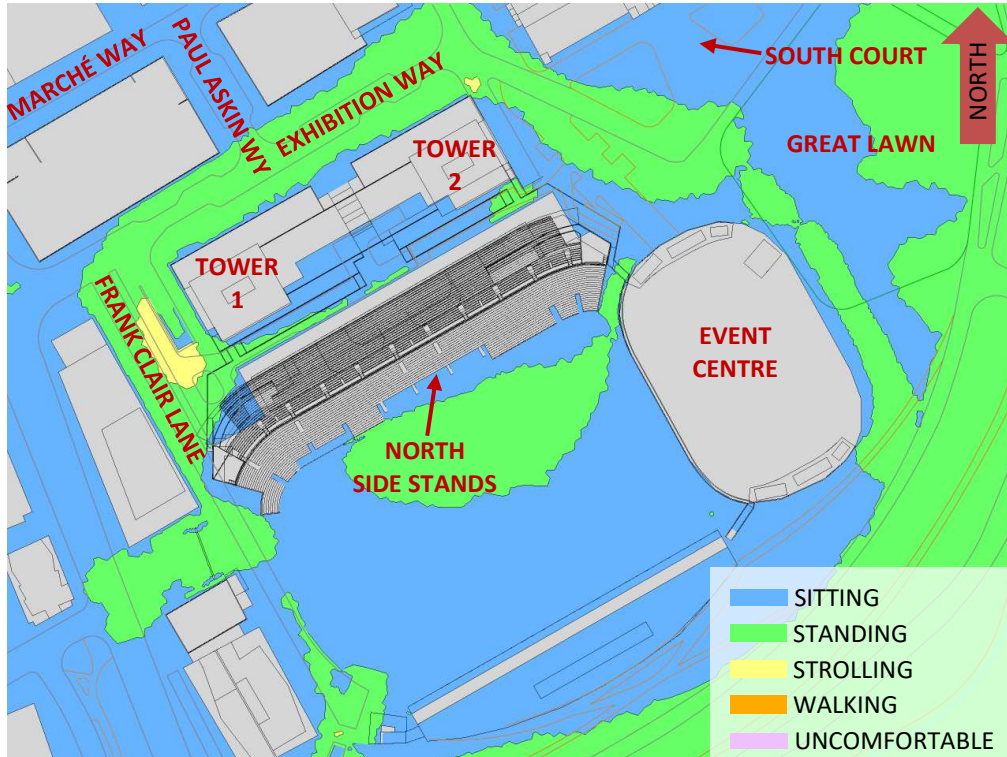

FIGURE 5A: AUTUMN – WIND COMFORT, TD PLACE – PROPOSED

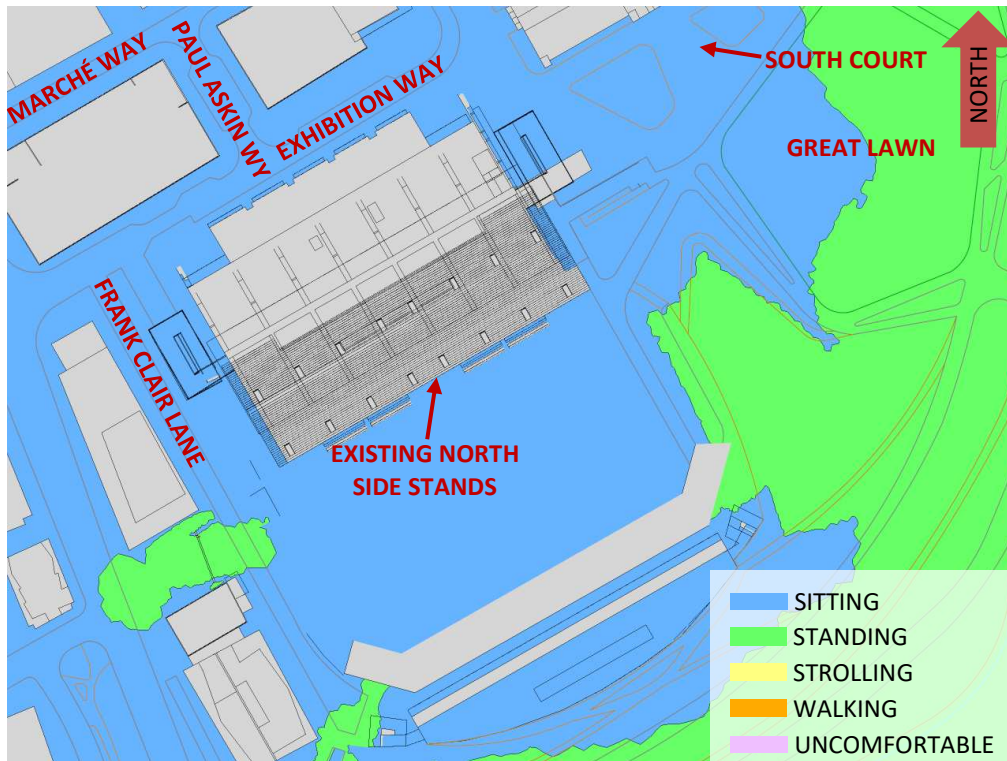

FIGURE 5B: AUTUMN – WIND COMFORT, TD PLACE – EXISTING



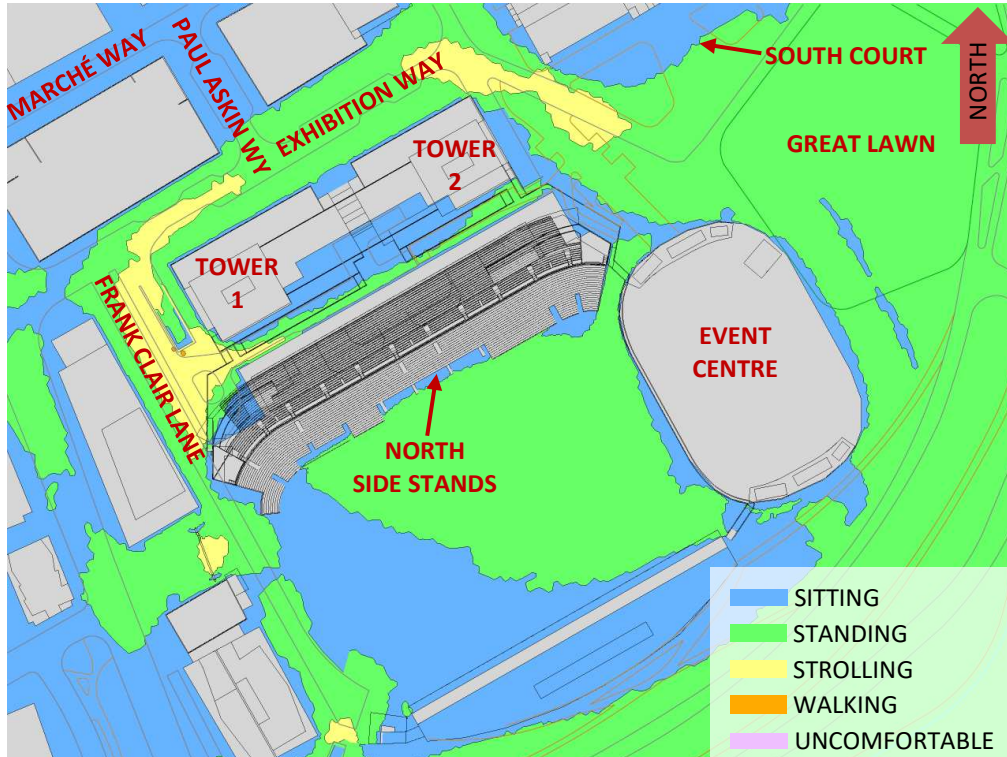

FIGURE 6A: WINTER – WIND COMFORT, TD PLACE – PROPOSED

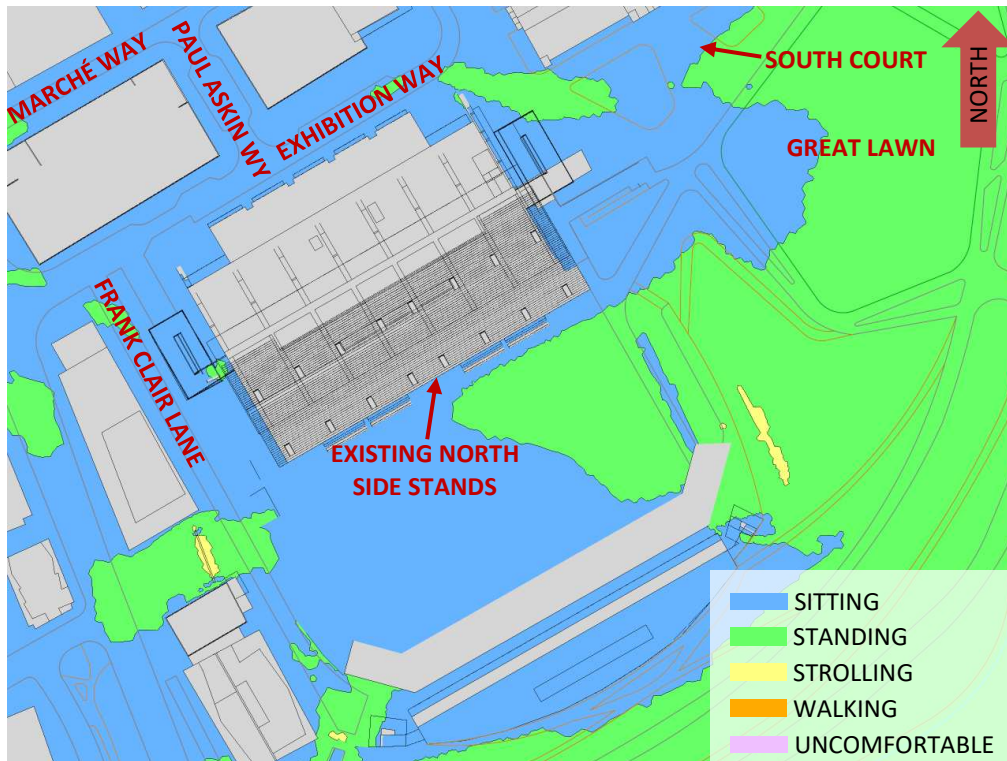

FIGURE 6B: WINTER – WIND COMFORT, TD PLACE – EXISTING



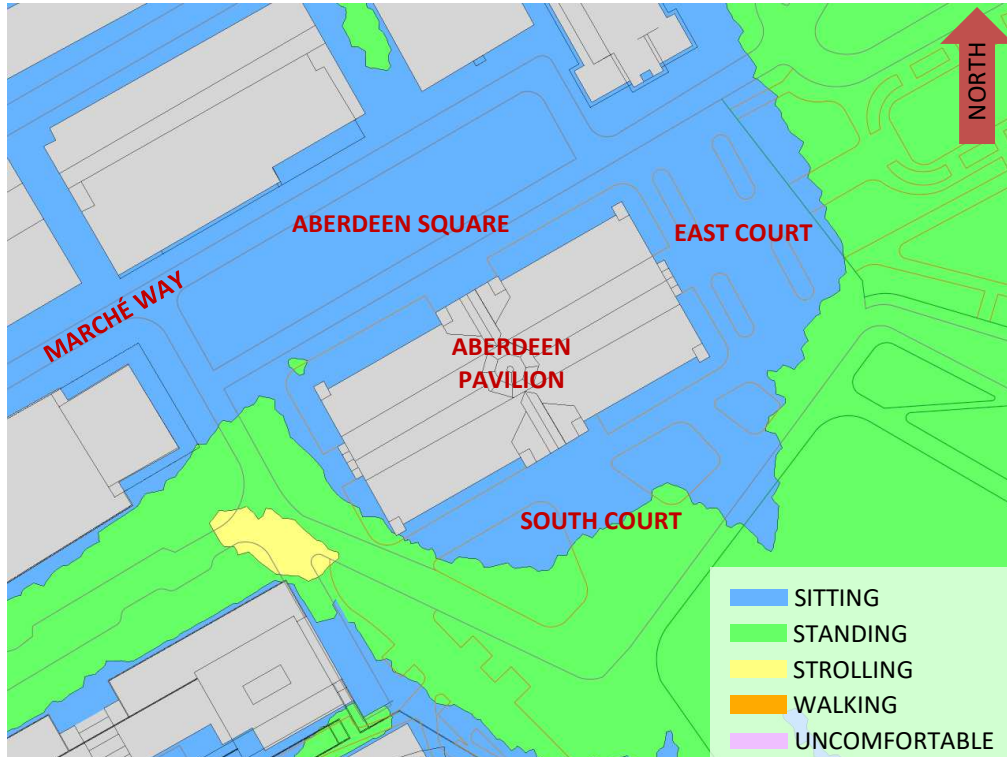

FIGURE 7A: SPRING – WIND COMFORT, ABERDEEN PAVILION – PROPOSED

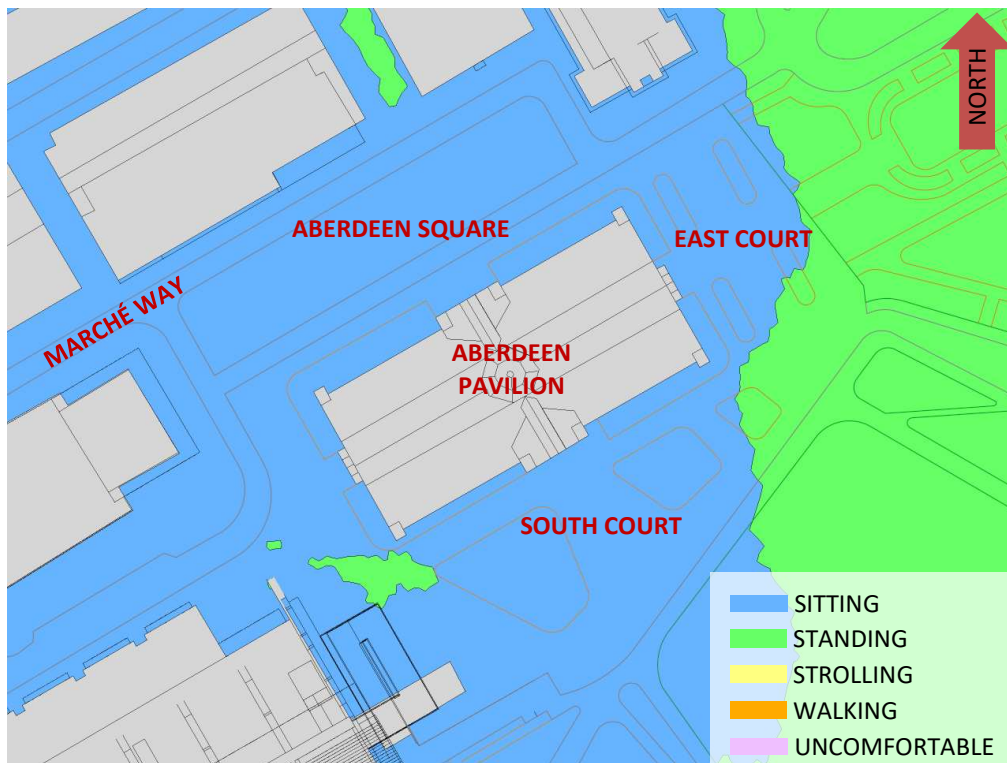

FIGURE 7B: SPRING – WIND COMFORT, ABERDEEN PAVILION – EXISTING



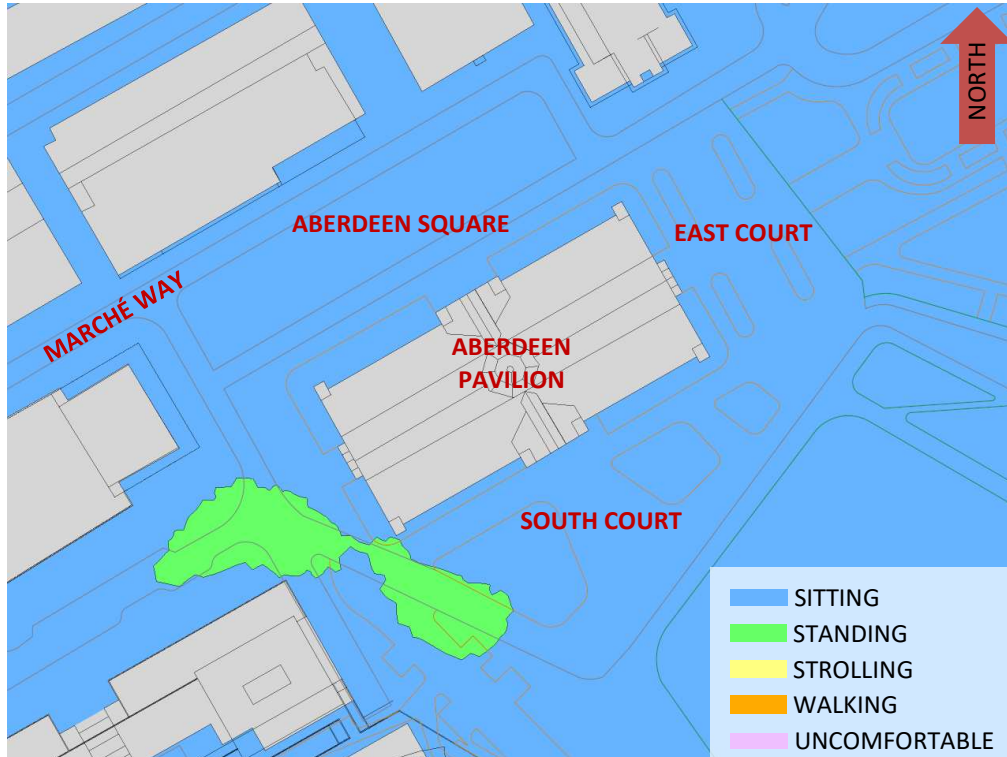

FIGURE 8A: SUMMER – WIND COMFORT, ABERDEEN PAVILION – PROPOSED

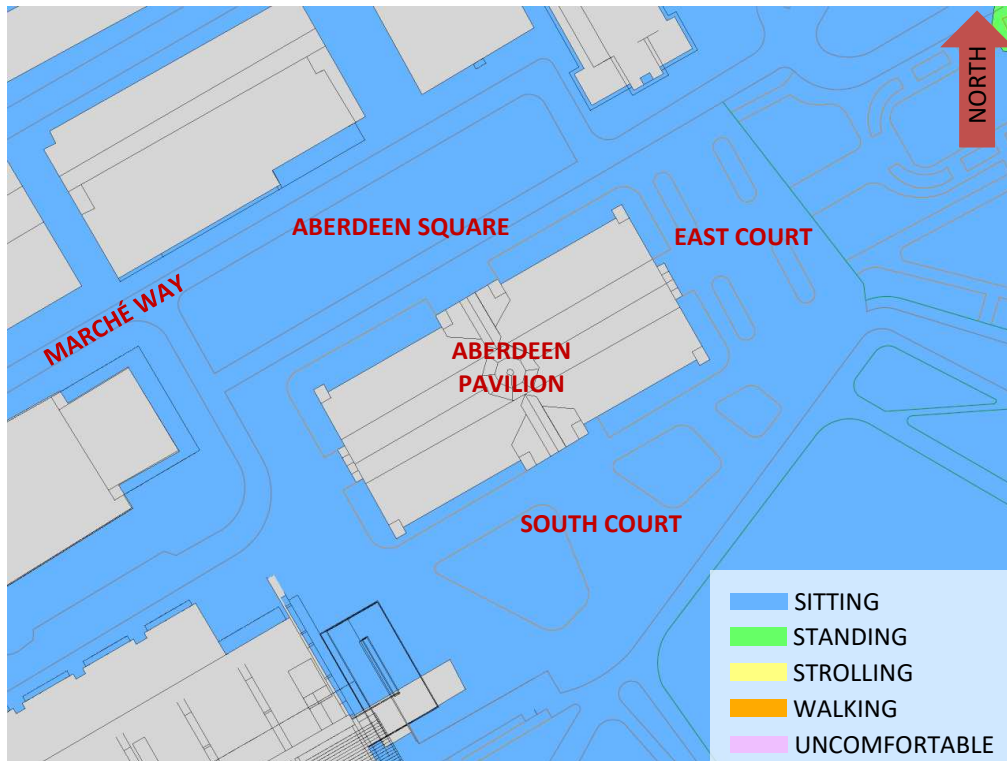

FIGURE 8B: SUMMER – WIND COMFORT, ABERDEEN PAVILION – EXISTING



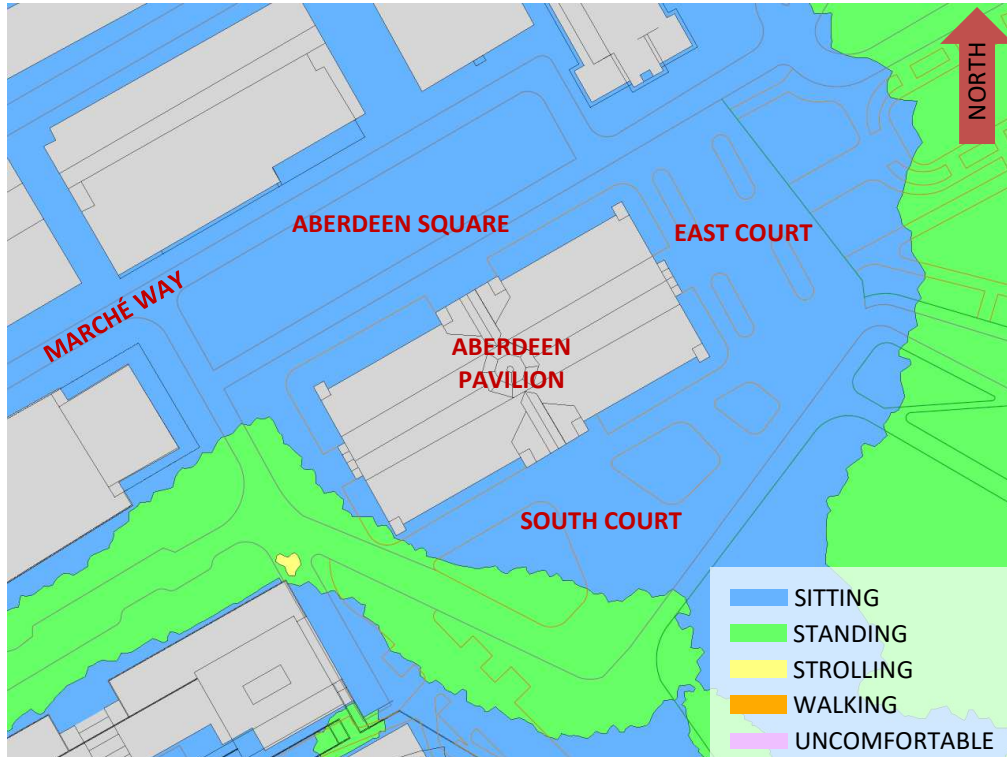

FIGURE 9A: AUTUMN – WIND COMFORT, ABERDEEN PAVILION – PROPOSED

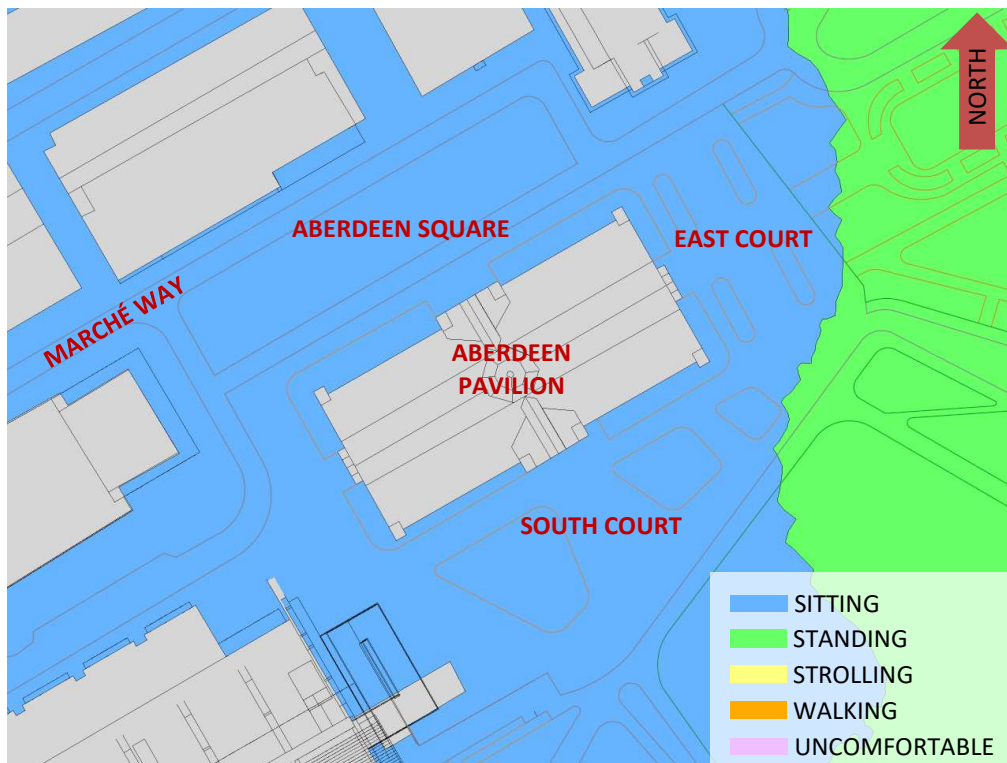

FIGURE 9B: AUTUMN – WIND COMFORT, ABERDEEN PAVILION – EXISTING



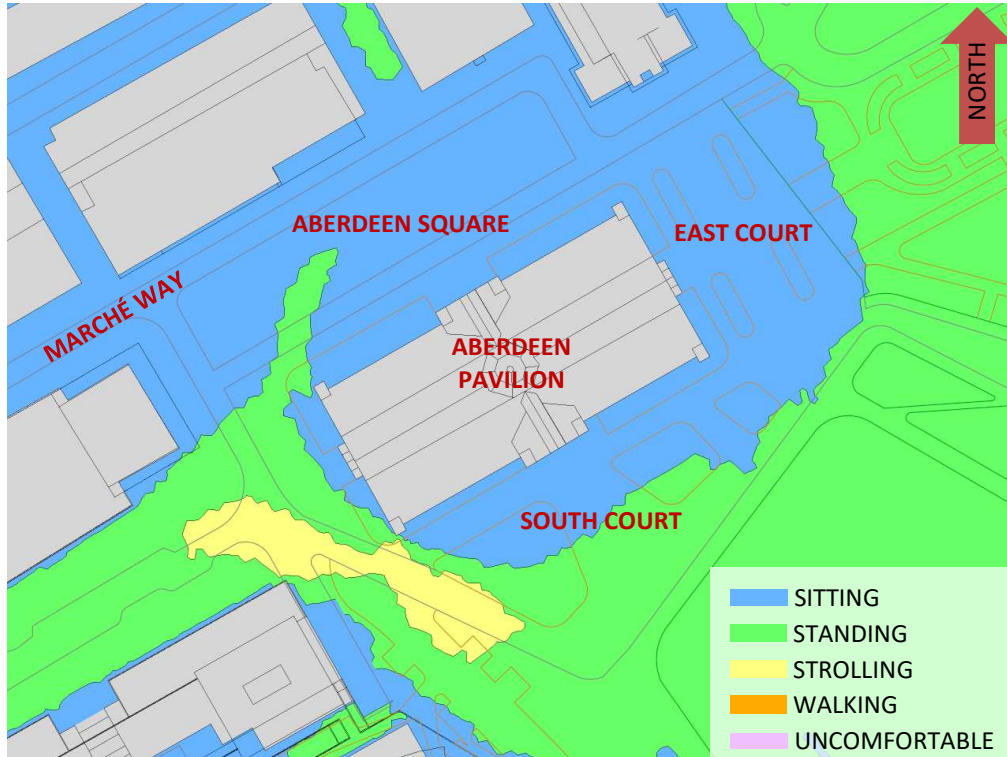

FIGURE 10A: WINTER – WIND COMFORT, ABERDEEN PAVILION – PROPOSED

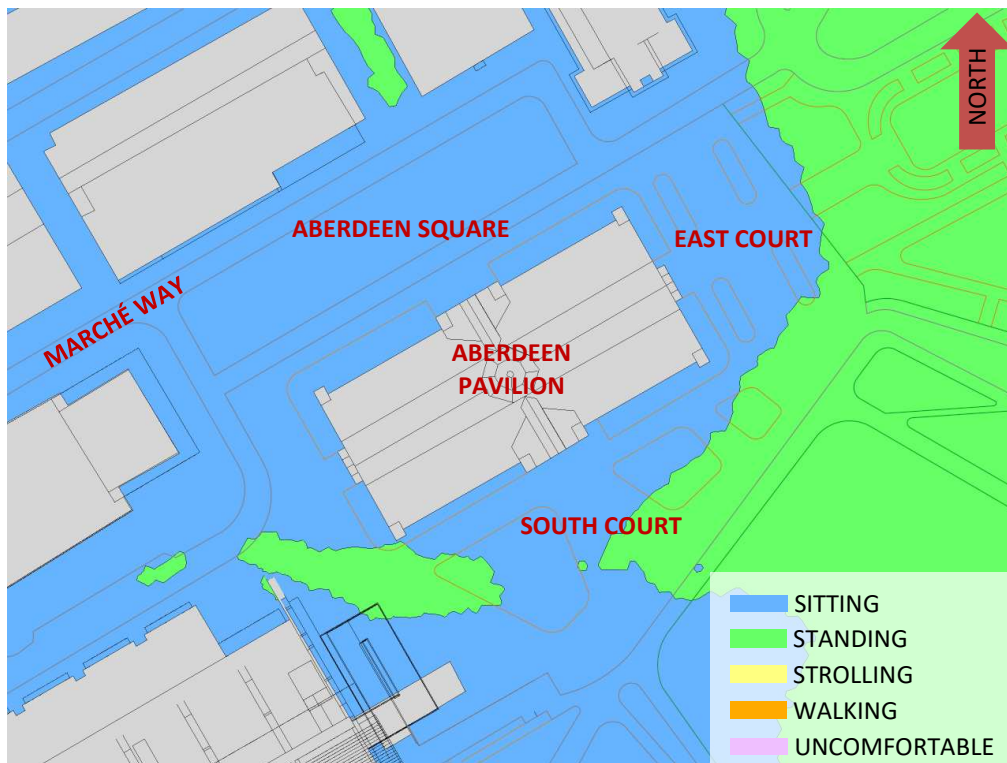

FIGURE 10B: WINTER – WIND COMFORT, ABERDEEN PAVILION – EXISTING



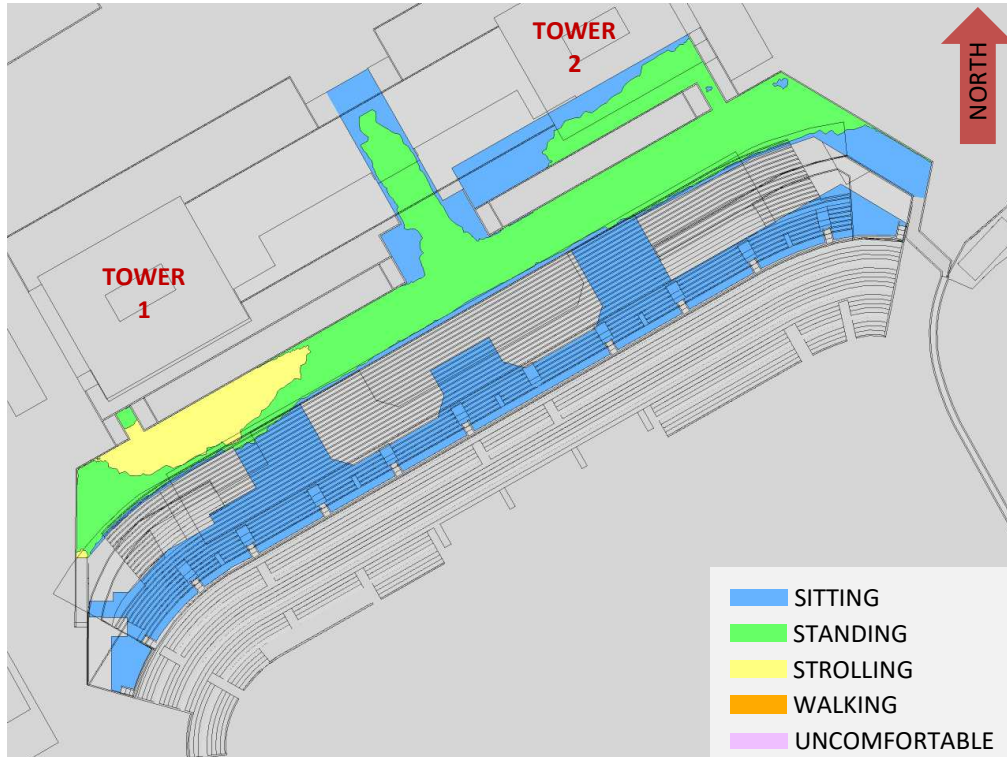

FIGURE 11A: SPRING – WIND COMFORT, PUBLIC PROMENADE

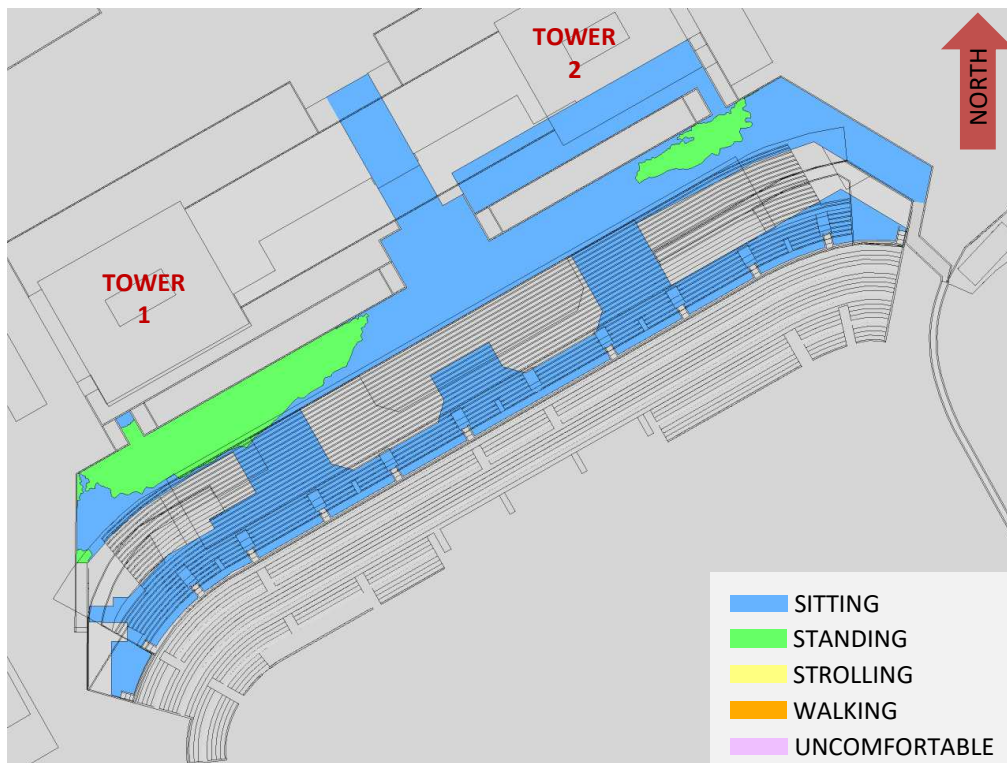

FIGURE 11B: SUMMER – WIND COMFORT, PUBLIC PROMENADE



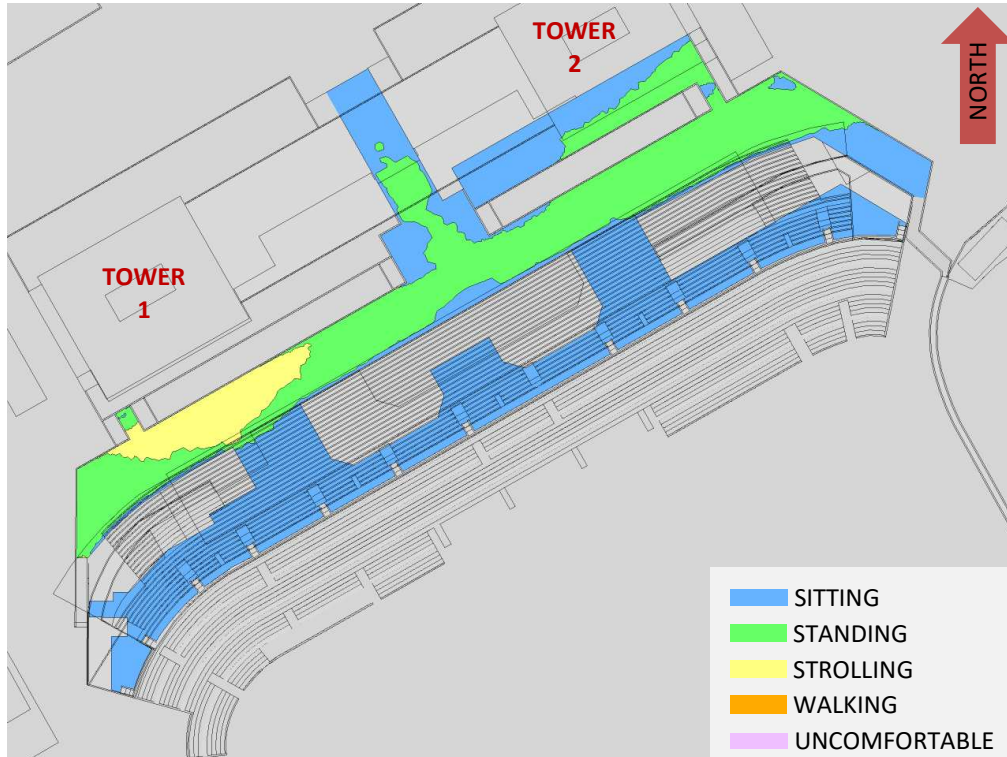

FIGURE 11C: AUTUMN – WIND COMFORT, PUBLIC PROMENADE

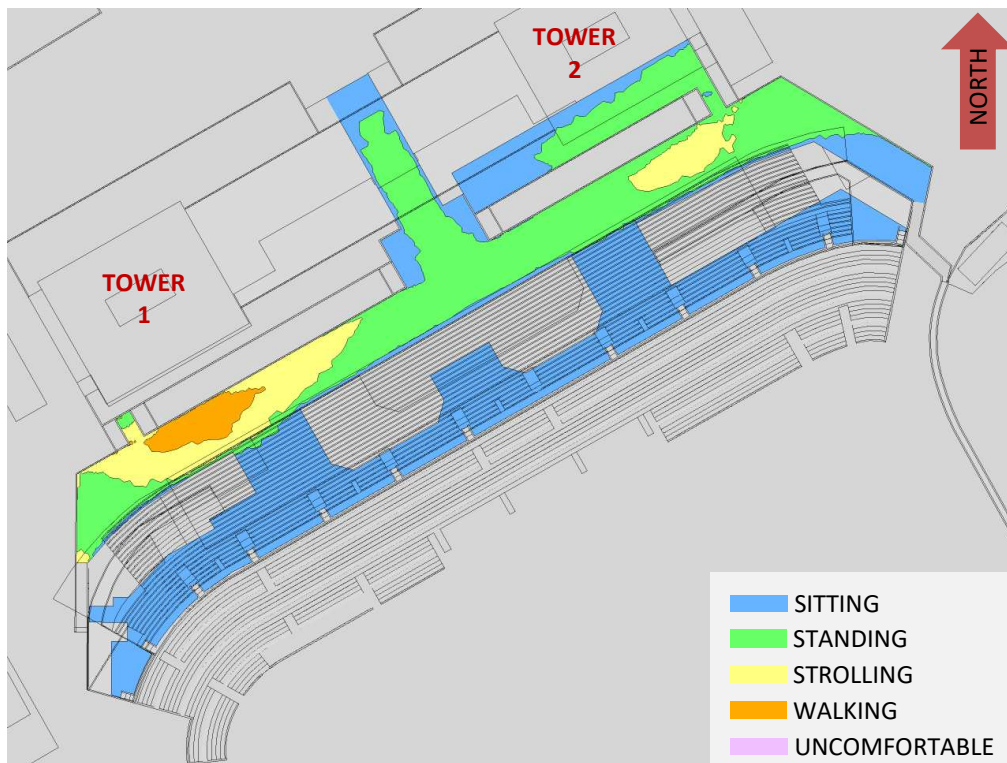
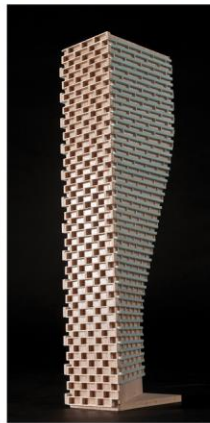

FIGURE 11D: WINTER – WIND COMFORT, PUBLIC PROMENADE



GRADIENTWIND

ENGINEERS & SCIENTISTS



APPENDIX A

SIMULATION OF THE ATMOSPHERIC BOUNDARY LAYER

SIMULATION OF THE ATMOSPHERIC BOUNDARY LAYER

The atmospheric boundary layer (ABL) is defined by the velocity and turbulence profiles according to industry standard practices. The mean wind profile can be represented, to a good approximation, by a power law relation, Equation (1), giving height above ground versus wind speed (1), (2).

$$U = U_g \left(\frac{Z}{Z_g} \right)^\alpha \quad \text{Equation (1)}$$

where, U = mean wind speed, U_g = gradient wind speed, Z = height above ground, Z_g = depth of the boundary layer (gradient height), and α is the power law exponent.

For the model, U_g is set to 6.5 metres per second, which approximately corresponds to the 60% mean wind speed for Ottawa based on historical climate data and statistical analyses. When the results are normalized by this velocity, they are relatively insensitive to the selection of gradient wind speed.

Z_g is set to 540 m. The selection of gradient height is relatively unimportant, so long as it exceeds the building heights surrounding the subject site. The value has been selected to correspond to our physical wind tunnel reference value.

α is determined based on the upstream exposure of the far-field surroundings (that is, the area that it not captured within the simulation model).

Table 1 presents the values of α used in this study, while Table 2 presents several reference values of α . When the upstream exposure of the far-field surroundings is a mixture of multiple types of terrain, the α values are a weighted average with terrain that is closer to the subject site given greater weight.

TABLE 1: UPSTREAM EXPOSURE (ALPHA VALUE) VS TRUE WIND DIRECTION

Wind Direction (Degrees True)	Alpha Value (α)
0	0.27
49	0.24
74	0.24
103	0.24
167	0.24
197	0.24
217	0.24
237	0.22
262	0.24
282	0.26
301	0.25
324	0.28

TABLE 2: DEFINITION OF UPSTREAM EXPOSURE (ALPHA VALUE)

Upstream Exposure Type	Alpha Value (α)
Open Water	0.14-0.15
Open Field	0.16-0.19
Light Suburban	0.21-0.24
Heavy Suburban	0.24-0.27
Light Urban	0.28-0.30
Heavy Urban	0.31-0.33

The turbulence model in the computational fluid dynamics (CFD) simulations is a two-equation shear-stress transport (SST) model, and thus the ABL turbulence profile requires that two parameters be defined at the inlet of the domain. The turbulence profile is defined following the recommendations of the Architectural Institute of Japan for flat terrain (3).

$$I(Z) = \begin{cases} 0.1 \left(\frac{Z}{Z_g} \right)^{-\alpha-0.05}, & Z > 10 \text{ m} \\ 0.1 \left(\frac{10}{Z_g} \right)^{-\alpha-0.05}, & Z \leq 10 \text{ m} \end{cases} \quad \text{Equation (2)}$$

$$L_t(Z) = \begin{cases} 100 \text{ m} \sqrt{\frac{Z}{30}}, & Z > 30 \text{ m} \\ 100 \text{ m}, & Z \leq 30 \text{ m} \end{cases} \quad \text{Equation (3)}$$

where, I = turbulence intensity, L_t = turbulence length scale, Z = height above ground, and α is the power law exponent used for the velocity profile in Equation (1).

Boundary conditions on all other domain boundaries are defined as follows: the ground is a no-slip surface; the side walls of the domain have a symmetry boundary condition; the top of the domain has a specified shear, which maintains a constant wind speed at gradient height; and the outlet has a static pressure boundary condition.

REFERENCES

- [1] P. Arya, "Chapter 10: Near-neutral Boundary Layers," in *Introduction to Micrometeorology*, San Diego, California, Academic Press, 2001.
- [2] S. A. Hsu, E. A. Meindl and D. B. Gilhousen, "Determining the Power-Law Wind Profile Exponent under Near-neutral Stability Conditions at Sea," vol. 33, no. 6, 1994.
- [3] Y. Tamura, H. Kawai, Y. Uematsu, K. Kondo and T. Okhuma, "Revision of AIJ Recommendations for Wind Loads on Buildings," in *The International Wind Engineering Symposium, IWES 2003*, Taiwan, 2003.

DRAFT

Lansdowne Park - Event Centre

Ottawa, ON

HERITAGE IMPACT ASSESSMENT

June 7, 2024

EBA

DRAFT

Project # 21-306-02
Prepared by PE / SI / EC / NP / AG

PREPARED FOR:

Lansdowne Park Redevelopment Project
Planning, Real Estate and Economic Development
City of Ottawa
110 Laurier Avenue West
Ottawa, ON K1P 1J1

PREPARED BY:

ERA Architects Inc.
#600-625 Church St
Toronto ON, M4Y 2G1
416-963-4497

CONTENTS

STATEMENT OF PROFESSIONAL QUALIFICATIONS	IV
EXECUTIVE SUMMARY	VI
1 OVERVIEW	8
2 CURRENT CONDITIONS	11
3 PROPOSED DEVELOPMENT	22
4 IMPACT ASSESSMENT	24
5 CONSERVATION STRATEGY & FURTHER MITIGATION	36
6 PRELIMINARY LIGHTING, SIGNAGE & INTERPRETATION CONSIDERATIONS	40
7 NEXT STEPS	44
8 CONCLUSION	45
APPENDIX A: REFERENCES	46
APPENDIX B: SCOPED TERMS OF REFERENCE	49

STATEMENT OF PROFESSIONAL QUALIFICATIONS

ERA Architects Inc. (ERA) specializes in heritage conservation, architecture, planning and landscape as they relate to historical places. This work is driven by our core interest in connecting heritage issues to wider considerations of urban design and city building, and to broader set of cultural values that provide perspective to our work at different scales.

In our 30 years of work, we've provided the highest level of professional services to our clients in both the public and private sector out of offices in Toronto, Montreal and Ottawa. We have a staff of more than 100, and our Principals and Associates are members of associations that include: the Ontario Association of Architects (OAA), the Canadian Association of Heritage Professionals (CAHP) and the Royal Architectural Institute of Canada (RAIC).

Philip Evans OAA, MRAIC, CAHP is a Principal at ERA and the founder of Culture of Outports and *small*. Over the course of 17 years working in the field of heritage conservation, he has led a wide range of conservation, adaptive reuse, design, and feasibility planning projects.

Samantha Irvine JD, CAHP is a Senior Associate with the heritage planning team at ERA, where she has overseen projects that impact culturally significant buildings, neighbourhoods and landscapes since 2015. She holds a BA in History and Sociology from McGill University (Great Distinction); MA degrees in Historical & Sustainable Architecture (NYU) and Sustainable Urbanism (Wales); and a JD from Queen's University. She is a member of the Ontario Bar Association and a former Fellow of Sustainable Urbanism with the Prince's Foundation in London, England.

Emma Cohlmeier is a Senior Project Manager with the heritage planning team at ERA. She is a Registered Professional Planner (RPP) and a Member of the Canadian Institute of Planners (MCIP). Emma completed a Bachelor of Arts Degree from the University of Guelph and a Master's Degree in Urban Planning from the University of Toronto.

Neil Phillips is a Project Manager with the heritage planning team at ERA Architects. He holds a Master of Landscape Architecture from the University of Toronto, a certificate in Urban Design from Harvard University, a Bachelor of Urban and Regional Planning from Toronto

Metropolitan University (formerly Ryerson University), and a Honours Bachelor of Public Administration from the University of Ottawa.

Anna Gutkowska is a Heritage Planner at ERA. She earned a Master of Planning in Urban Development from Toronto Metropolitan University (formerly Ryerson University) and a Bachelor of Arts (Honours) in History, also from Toronto Metropolitan University.

EXECUTIVE SUMMARY

Background

This Heritage Impact Assessment (“HIA”) has been prepared by ERA Architects Inc. (“ERA”) to accompany the Site Plan Control Application for the Event Centre (the “Site”) at Lansdowne Park, Ottawa.

Lansdowne Park is bounded by Bank Street to the west, Holmwood Avenue to the north, and Queen Elizabeth Driveway and the Rideau Canal to the east and south. Owned by the City of Ottawa, Lansdowne Park spans 40 acres and includes commercial, residential, sports, recreational, and cultural facilities.

The Site is located in the southern portion of Lansdowne Park, covering the areas that include the east edge of TD Place Stadium, the Great Porch, the Great Lawn, and the Hill/Berm.

In 2012, the City entered into a 40-year partnership with the Ottawa Sports and Entertainment Group to revitalize Lansdowne Park. Following Council’s December 2020 directive to consider options to enhance Lansdowne’s sustainability and financial viability, the Lansdowne 2.0 Concept Plan was approved. This plan includes a new standalone Event Centre, new north stadium stands, two residential mixed-use towers, new retail, and public realm enhancements.

This HIA considers only the proposed development of the Event Centre. Future stages of the Lansdowne 2.0 development, including the proposed new residential towers and north stadium stands will be detailed in forthcoming Site Plan submissions.

Cultural Heritage Resources

The Site is adjacent and near to the following built heritage resources of Lansdowne Park:

- Aberdeen Pavilion: Designated a National Historic Site in 1983 and Under Part IV of the Ontario Heritage Act (the “OHA”) in 1984.
- Horticulture Building: Designated under Part IV of the OHA in 1994.

Lansdowne Park, including the Aberdeen Pavilion and Horticulture Building, is subject to a 2012 Heritage Conservation Easement Agreement (“HCEA”) between the City of Ottawa and the Ontario Heritage Trust, which includes protected view corridors, and delineated Framing and Setting Lands.

Lansdowne Park is also subject to a 1993 Cost-Share Agreement between the City of Ottawa and Parks Canada, which includes protected vistas of the Aberdeen Pavilion.

The Site is adjacent to the following cultural heritage landscapes:

- Queen Elizabeth Driveway (recognized as a Cultural Landscape of Capital Value by the National Capital Commission);
- Rideau Canal (National Historic Site, a Canadian Heritage River, and a UNESCO World Heritage Site); and
- Colonel By Drive (recognized as a Cultural Landscape of Capital Value by the National Capital Commission).

Proposed Development

The proposed development includes a new 5,500-seat standalone Event Centre and adjoining landscape modifications to the Hill/Berm, the Great Porch and the Great Lawn. The proposal includes the reshaping of the Hill/Berm and relocation of the Moving Surfaces public art installation.

Impact of Proposed Development

The proposed development has been designed and situated to minimize impact on the protected HCEA and Cost-Share Agreement views. Some minor visual impact is anticipated on the HCEA and Cost-Share Agreement views of the Aberdeen Pavilion, as well as the dynamic views from adjacent cultural heritage landscapes. While the impact on views of the Aberdeen Pavilion is minimal, the introduction of a large structure to the Framing Lands alters the existing condition and decreases the extent of public open space.

While the encroachment of the Event Centre onto the Framing Lands presents an adverse impact on the Framing Lands, the original functions of the public areas, including the Great Lawn, Hill/Berm, and Great Porch, are maintained.

The proposed Event Centre introduces a new, significant architectural element to Lansdowne Park. While the Event Centre does not inherently isolate the Aberdeen Pavilion, the introduction of a new building in such close proximity may alter the landmark status of the Aberdeen Pavilion as the “heart of the Park.”

The proposed development does not present a direct impact on the adjacent cultural heritage resources of the Rideau Canal, including the Queen Elizabeth Driveway and the Colonel By Drive cultural landscapes.

The proposed development does not present an impact on the Horticulture Building.

Mitigation

Visual impacts on the Aberdeen Pavilion have been mitigated through the siting, placement, and relatively low height of the proposed Event Centre.

The reduction in public space has been mitigated through design measures that enhance the usability of areas within and surrounding the proposed Event Centre while retaining the original intent of key public areas.

Further mitigation is encouraged to ensure overall design cohesion throughout subsequent phases of the Lansdowne 2.0 development process.

Conclusion and Next Steps

The proposed development appropriately conserves the cultural heritage value of Lansdowne Park and its adjacent cultural heritage landscapes, while allowing for its continued evolution.

Additional detailed studies are recommended, including a Heritage Interpretation Plan, Heritage Lighting Plan, and Heritage Protection Plan.

1 OVERVIEW

1.1 Introduction

This Heritage Impact Assessment (“HIA”) has been prepared by ERA Architects Inc. (“ERA”) to accompany the Site Plan Control Application for the Event Centre at Lansdowne Park, Ottawa. While background information is provided on Lansdowne Park, as a whole, this scoped HIA focuses specifically on the proposed new Event Centre (the “Site”).

This report follows ERA’s June 2023 HIA (“June 2023 HIA”), which accompanied the Official Plan Amendment (“OPA”) and Zoning By-law Amendment (“ZBLA”) applications for the overall intensification of Lansdowne Park as outlined in the Lansdowne 2.0 Concept Plan.

1.2 Background

Lansdowne Park, owned by the City of Ottawa, is a major Ottawa destination with over a century of history as a gathering place for both residents and tourists. In 2012, City Council established a 30-year partnership with the Ottawa Sports and Entertainment Group (“OSEG”), which was later extended to 40 years, to revitalize Lansdowne Park. Lansdowne Park was reimagined to include residential, recreational and retail uses, as well as an enhanced public realm.

In December 2020, City Council directed that a working group made up of City and OSEG representatives consider options to enhance the sustainability and long-term financial viability of Lansdowne’s operations and the partnership. In July 2021, Council agreed to move forward with the recommended framework for the continued evolution of Lansdowne Park (Lansdowne 2.0).

In June 2023, the City of Ottawa submitted an Official Plan and Zoning By-law Amendment application for the Lansdowne 2.0 project. This submission was accompanied by the June 2023 Heritage Impact Assessment (HIA), which provided a comprehensive evaluation of potential impacts on existing heritage resources and outlined preliminary conservation design parameters to guide future development phases.

In November 2023, City Council granted approval to proceed to the next stage of planning for Lansdowne 2.0. The Council decision resulted in several Concept Plan approvals, including a new 5,500 seat Event Centre, new North Stadium Stands with 11,200 seats, two residential mixed-use buildings up to 40 stories in height, new retail, and public realm enhancements.

1.3 Report Scope

This HIA has been drafted in accordance with the requirements provided in the “Event Centre Site Plan: Scoped Heritage Impact Assessment” prepared and reviewed by staff from the City of Ottawa, the National Capital Commission (“NCC”), Parks Canada (the Indigenous Affairs and Cultural Heritage Directorate), and the Ontario Heritage Trust (“OHT”) (see Appendix B).

This HIA evaluates the potential impacts of the proposed Event Centre on the cultural heritage resources of Lansdowne Park, including the Aberdeen Pavilion and the Horticulture Building, as well as the adjacent resources of the Rideau Canal, Queen Elizabeth Driveway (“QED”), and Colonel By Drive cultural landscapes. Additionally, it assesses the impact on the parameters identified in the 2012 OHT Heritage Conservation Easement Agreement (“HCEA”), including protected views to and of the cultural heritage resources of Lansdowne Park, particularly the Aberdeen Pavilion, which is adjacent to the Site.

Future stages of the Lansdowne 2.0 development, including the proposed new residential tower components and north stadium stands and retail podium will be detailed in forthcoming Site Plan submissions. Consequently, the graphics and visuals in this report do not depict these additional components of the Lansdowne 2.0 development.

This report was prepared with reference to the following documents:

- The Ontario Heritage Act (R.S.O. 1990);
- Planning Act (R.S.O. 1990);
- Aberdeen Pavilion Cost-Share Agreement (1993);
- Definition and Assessment of Cultural Heritage Landscapes of Heritage Value on NCC Lands (2004);
- 2005 Rideau Canal National Historic Site of Canada Management Plan (2005);
- Standards and Guidelines for the Conservation of Historic Places in Canada (2010);
- Lansdowne Park: Statement of Cultural Values and Heritage Impact Assessment (2010);
- Lansdowne Park Heritage Brief (2010);
- Lansdowne Partnership Plan (2012);
- Lansdowne Park Heritage Conservation Easement Agreement (2012);
- The Province of Ontario’s Provincial Policy Statement (2020)

- City of Ottawa Official Plan (2021);
- National Capital Commission Heritage Inventory: Queen Elizabeth Driveway (2022);
- Lansdowne Park: Heritage Impact Assessment (2023); and
- Working with Cultural Landscapes: A Guide for the National Capital Region (2023).

1.4 Property Owner and Representative Information

Owner: City of Ottawa

Address: 110 Laurier Avenue West, Ottawa, ON K1P 1J1

Contact Name: Sean Moore

E-mail Address: Sean.Moore@ottawa.ca

2 CURRENT CONDITIONS

2.1 Site Location and Description



Location map with the Site outlined in a dashed black line (GeoOttawa, 2024; annotated by ERA).

The Site is located within Lansdowne Park. Lansdowne Park is bounded by Bank Street to the west, Holmwood Avenue to the north, and Queen Elizabeth Driveway and the Rideau Canal to the east and south. Lansdowne Park contains a mix of commercial, residential, sports, recreational, and cultural facilities.

Central to the park is the c.1898 Aberdeen Pavilion, which is surrounded by four public plazas: the East and West Courts, Aberdeen Square to the north, and the Great Porch to the south. South of the Great Porch is the Great Lawn, a large public open space. Framing the north side of the East Court and the east side of Aberdeen Square is the c.1914 Horticulture Building.

The northern and western sectors of the park house its built structures, encompassing commercial, residential, and recreational facilities. In contrast, the eastern and southern areas consist of park spaces, hardscaped and softscaped areas, basketball courts, skate park, and access to underground parking.

The Site is located in the southern portion of Lansdowne Park, covering the areas that include the east edge of TD Place Stadium, the Great Porch, the Great Lawn, and the Hill/Berm.



Aerial imagery showing the Site and its surrounding context within Lansdowne Park. The Site is outlined with a dashed white line (Google Earth; annotated by ERA).

- Public Realm
- Designated Heritage Buildings
- Commercial/Residential
- Stadium and Arena

2.2 History

The history of Lansdowne Park, including the area's pre-contact and Indigenous history, is documented in the June 2023 HIA. The history of Lansdowne Park in the context of European settlement is also documented in the Lansdowne Park: Statement of Cultural Heritage Values and Heritage Impact Assessment (2010) prepared by Commonwealth Resource Management Limited.

2.3 Heritage Context

2.3.1 Regulatory Context

Lansdowne Park contains the Aberdeen Pavilion and Horticulture Building, both of which are designated under Part IV of the Ontario Heritage Act (the “OHA”). The Aberdeen Pavilion was designated a National Historic Site (“NHS”) in 1983.

Parts of Lansdowne Park, including the Aberdeen Pavilion and Horticulture Building are subject to a 2012 HCEA between the City of Ottawa and the OHT. Though Lansdowne Park is not a Provincially-owned resource, the HCEA considers its value in the context of O. Reg 10/06: Criteria for Determining Cultural Heritage Value or Interest of Provincial Significance. The HCEA recognizes not only the Aberdeen Pavilion and Horticulture Building but also specific views of these buildings, the Setting Lands surrounding them, and the Framing Lands that provide lateral foregrounds to these view as having provincial heritage value.

Lansdowne Park is also subject to the 1993 Parks Canada and City of Ottawa Cost-Share Agreement and accompanying (1990) Aberdeen Pavilion Conservation Report, which identifies the importance of maintaining clear vistas at each of the four entries to the Aberdeen Pavilion.

Beyond these protected areas, Lansdowne Park includes spaces that have been redeveloped for various purposes, including commercial, residential, cultural, recreational, and sports and entertainment functions.

2.3.2 Adjacent and Nearby Heritage Resources

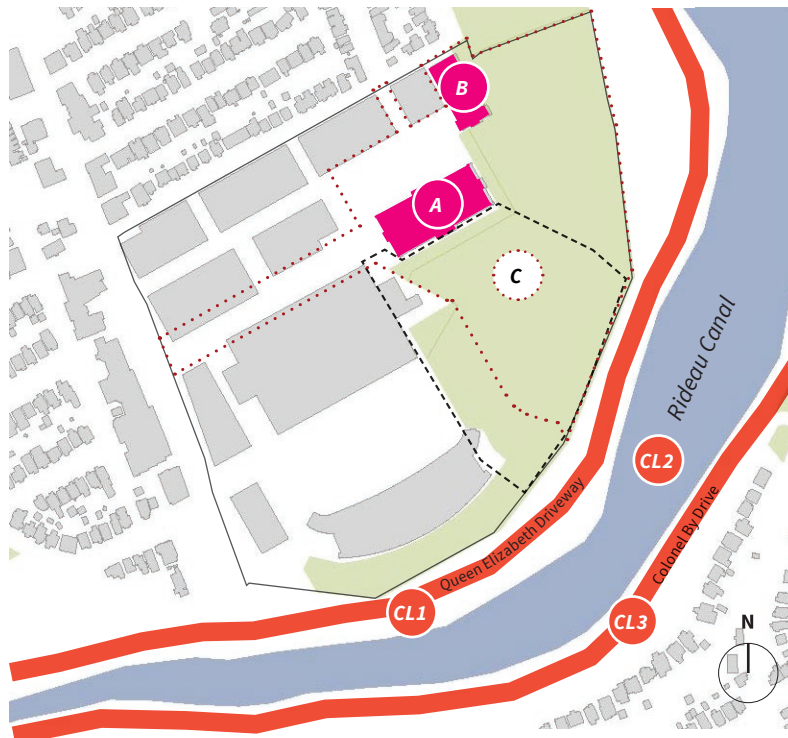

- A** Aberdeen Pavilion (Designated Part IV)
- B** Horticulture Building (Designated Part IV)
- C** Heritage Conservation Easement Agreement
- CL1** Queen Elizabeth Driveway
- CL2** Rideau Canal
- CL3** Colonel By Drive
- Site**

Context map showing adjacent and nearby heritage resources (GeoOttawa, 2023; annotated by ERA).

A *Aberdeen Pavilion (Designated Part IV and NHS)*

The Aberdeen Pavilion is an exhibition hall constructed in 1898. Designed by Moses C. Edey and the Dominion Bridge Company, the steel frame structure is clad in decorative pressed metal panels. Recognized as a NHS in 1983, it was designated in 1984 under Part IV of the OHA (By-law 22-84).



1945 Aberdeen Pavilion (formerly known as the Manufacturers Building (Heritage Ottawa).

B *Horticulture Building (Designated Part IV)*

The current Horticulture Building is an exhibition hall constructed in 1914. Designed by Francis Sullivan, the brick-clad building consists of a two-storey front section designed in the Prairie Style with a large exhibition hall featuring a clear-span roof to the rear. Designated in 1994 under Part IV of the OHA (By-law 8-94). In 2014, the building was relocated approximately 140 metres eastward from its original location.



1914 Announcement for the new Horticulture Building at Lansdowne Park (Ottawa Journal).

Heritage Conservation Easement Agreement

The 2012 HCEA for Lansdowne Park is a legal agreement between the City of Ottawa and the OHT made to ensure that the heritage value of Lansdowne Park will be preserved in perpetuity. The HCEA defines the provincial cultural heritage value of Lansdowne Park as encompassing:

- a) *The lands that surround the Buildings and create the immediate setting (the “Setting Lands”);*
- b) *The lands associated with significant views of the Aberdeen Pavilion (the “Views”);*
- c) *The lands that provide lateral foreground frames of the Views (the “Framing Lands”);*
- d) *The exteriors of the Buildings;*
- e) *The entire interior of the Aberdeen Pavilion and select interiors of the Horticulture Building; and*
- f) *The archaeological value.*

Queen Elizabeth Driveway

The QED is a 5.6 kilometre scenic parkway running along the west side of the Rideau Canal between the National Arts Centre and Preston Street. Originally known as the Rideau Canal Driveway, it formed part of Frederick Todd’s 1904 Plan for the Ottawa Improvement Commission. Recognized as a Cultural Landscape of Capital Value, it is owned by the federal government and managed by the NCC.

The NCC Heritage Inventory for the QED defines its Key Heritage Values as follows:

- *It is one of the city’s most well-known cultural landscapes and a major component of Ottawa’s identity.*
- *It was one of the first projects of the Ottawa Improvement Commission (OIC), which aimed to create a more beautiful city and develop and promote Ottawa’s identity as the capital of Canada.*
- *It provides an historic setting for a large section of the Rideau Canal National Historic Site of Canada and World Heritage Site in the central part of Ottawa.*



1927-1930 photograph aerial of Lansdowne Park and the Rideau Driveway (McRae, Lost Ottawa).



1974 photograph of QED west of Bank Street (Passfield, Parks Canada).

- For over a century, the Driveway has contributed to the aesthetic, historic, recreational, and cultural fabric of the city.
- It is the backbone of a linear park, more than six km in length, that follows the course of the Rideau Canal from the Ottawa River to Dow's Lake.
- Today, automobiles, cyclists, runners and walkers drive, race, run and stroll on or along the Driveway and its related pathways.
- It is firmly connected with the major events in the yearly cycle of the Capital – Winterlude, the ice-skating season, the Tulip Festival and the boating season.

Among the principal character-defining elements identified in the Heritage Inventory for the QED, those that are relevant to Lansdowne Park include:

- The presence of Lansdowne Park and the view of the Cattle Castle/Aberdeen Pavilion National Historic Site
- The experience of moving along the Driveway with a continuous flow of scenic vistas

CL2 Rideau Canal

The Rideau Canal is a 200 kilometre man-made waterway connecting the Ottawa River to Lake Ontario. Constructed between 1826 and 1832, it is the best preserved example of a slack-water canal system in North America. Recognized as a National Historic Site in 1925, and Canadian Heritage River in 2000, its cultural and historical value was further recognized in 2007 when it was inscribed on the World Heritage list as a UNESCO World Heritage Site. The Rideau Canal is owned by the federal government and is managed by Parks Canada.

The 2005 Rideau Canal National Historic Sites of Canada Management Plan defines the designated section of Rideau Canal as consisting:

of the lands and waters under the jurisdiction of Parks Canada including the bed of the Rideau Canal to the high water mark between the Ottawa River and the harbor in Kingston.

Along with the designated section of the Rideau Canal, the 2005 Rideau Canal World Heritage Site Management Plan includes a 30-metre buffer zone from the edge of the Rideau Canal to protect its Outstanding Universal Value. In the context of Lansdowne Park, this buffer zone falls within the NCC owned QED and Colonel By Drive rights-of-way.



1912 photograph of the Rideau Canal near Lansdowne Park (Ottawa Archives).



1913 photograph of south bank of Rideau Canal looking towards Bank Street Bridge (Library and Archives Canada).



1927 aerial of the Rideau Canal looking south towards Lansdowne Park (National Resources Canada).



1929 photograph of south bank of Rideau Canal from Bank Street bridge (Library and Archives Canada).

Colonel By Drive

Colonel By Drive is an 8.1 kilometre scenic parkway that runs along the east side of the Rideau Canal between Rideau Street and Hog's Back Road. It was constructed in the 1960s following the removal of the rail corridor along the Rideau Canal north of the Queensway. Recognized as a Cultural Landscape of Capital Value, it is owned by the federal government and managed by the NCC.

2.3.3 Significant Views

HCEA Protected Views

The 2012 HCEA identifies specific views, Setting Lands, and Framing Lands as being of cultural heritage value.

Heritage Value of the Setting Lands:

Within the Setting Lands, the visually-connected Aberdeen Pavilion and relocated Horticulture Building convey the historic use of Lansdowne Park as the grounds of the Central Canadian Exhibition. The Setting Lands consist of three significant views of the Aberdeen Pavilion and the Horticulture Building and include a view from Bank Street looking east to the west elevation (main façade) of the Aberdeen Pavilion, a view of the dome and north entrance of the Aberdeen Pavilion from Adelaide Street and a view of the west elevation of the Horticulture Building.

Heritage Value of the Views:

Significant views of the Aberdeen Pavilion include a view from the south of the Property looking north at the south elevation of the Aberdeen Pavilion, a view looking northwest towards the east and south elevations of the Aberdeen Pavilion from the southeast of the Property, a view looking west towards the east elevation of the Aberdeen Pavilion from the east of the Property, and a view looking southwest toward the east and north elevation (up to and including the Portico) of the Aberdeen Pavilion from the northeast of the Property.

Heritage Value of the Framing Lands:

The Framing Lands are visually and physically linked with the Aberdeen Pavilion and Horticulture Building; these lands provide the lateral context (i.e. built form and landscape) to the Views. The value, quality and visual impact of the Views are associated with the open space, and lack of tall buildings and large structures. The Framing Lands are also associated with the dynamic view of the upper portions of the Aberdeen Pavilion that is experienced along the southern and south-eastern edges of the Property from the scenic Queen Elizabeth Driveway. At the east and northeast side of the property the Framing Lands frame two distinct views of the Aberdeen Pavilion but are not part of the dynamic view.

Contextual Value:

The Horticulture Building, the Aberdeen Pavilion and the open space of the easement are located on the former Central Canada Exhibition

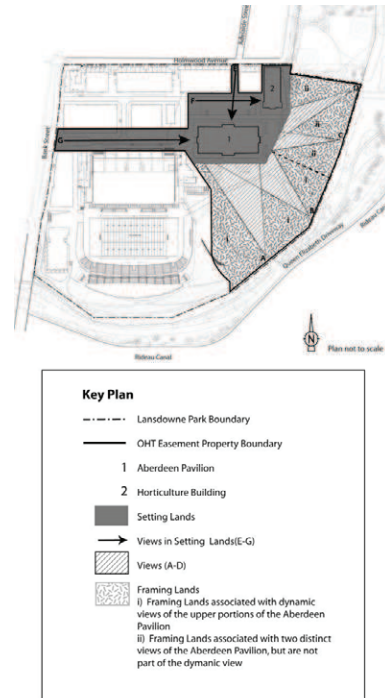

HCEA map depicting its boundaries, protected views, setting and framing lands, and locations of heritage buildings (City of Ottawa, 2012).

grounds at Lansdowne Park. Other buildings at Lansdowne Park include the Frank Clair Stadium, used as exhibition space, for sporting events and conferences. The Queen Elizabeth Driveway, which follows the edge of the Rideau Canal, is a scenic thoroughfare built by the predecessor of the National Capital Commission and wraps around the east and south of Lansdowne Park. The Rideau Canal, a UNESCO World heritage Site, was completed in 1832 and originally used for military purposes is now used as a recreational waterway. It also wraps around the south and east of the Park. The Rideau Canal is historically linked to Lansdowne Park; paddlewheel steamers dropped patrons off at wharves located at the exhibition grounds. Additionally, the exhibition grounds are located in the Glebe, This former suburb of Ottawa was annexed by the City in 1889. The Aberdeen Pavilion is a key building in the Glebe and its dome is visible from the neighbourhood - specifically from the banks of the Rideau Canal.

1993 Cost-Share Agreement

The 1993 Cost-Share Agreement between the City of Ottawa and Parks Canada identifies the importance of maintaining clear vistas at each of the four entries to the Aberdeen Pavilion, centred on the north, south, east, and west elevations. These vistas align with protected Viewpoints A, C, E, and G in the HCEA. For the purposes of this report, we have assumed the assessment of the Cost-Share Agreement views with the corresponding HCEA Viewpoints.

Summary of Additional Views for Evaluation

In addition to assessing the impacts of the proposed Event Centre on the views of the Aberdeen Pavilion defined in the 1993 Cost Share Agreement and the 2012 HCEA, the scoped Terms of Reference also directs this HIA to evaluate impacts on additional dynamic views of the Aberdeen Pavilion from adjacent cultural landscapes and roadways, including:

- Views from the Rideau Canal;
- Views from Bank Street; and
- Views from QED and Colonel By Drive, particularly the high-quality views identified in the NCC 2009 Rideau Canal Visual Assessment.

Dynamic View: A dynamic view implies an unfolding sequence of views of a subject, sometimes clearly seen, sometimes obscured for a while and revealed again later (NCC, 2007, p 45).

ERA selected various (dynamic) view points from adjacent lands along the extent of the Site boundary. The selected views capture the typical variety of experiences along the Rideau Canal.

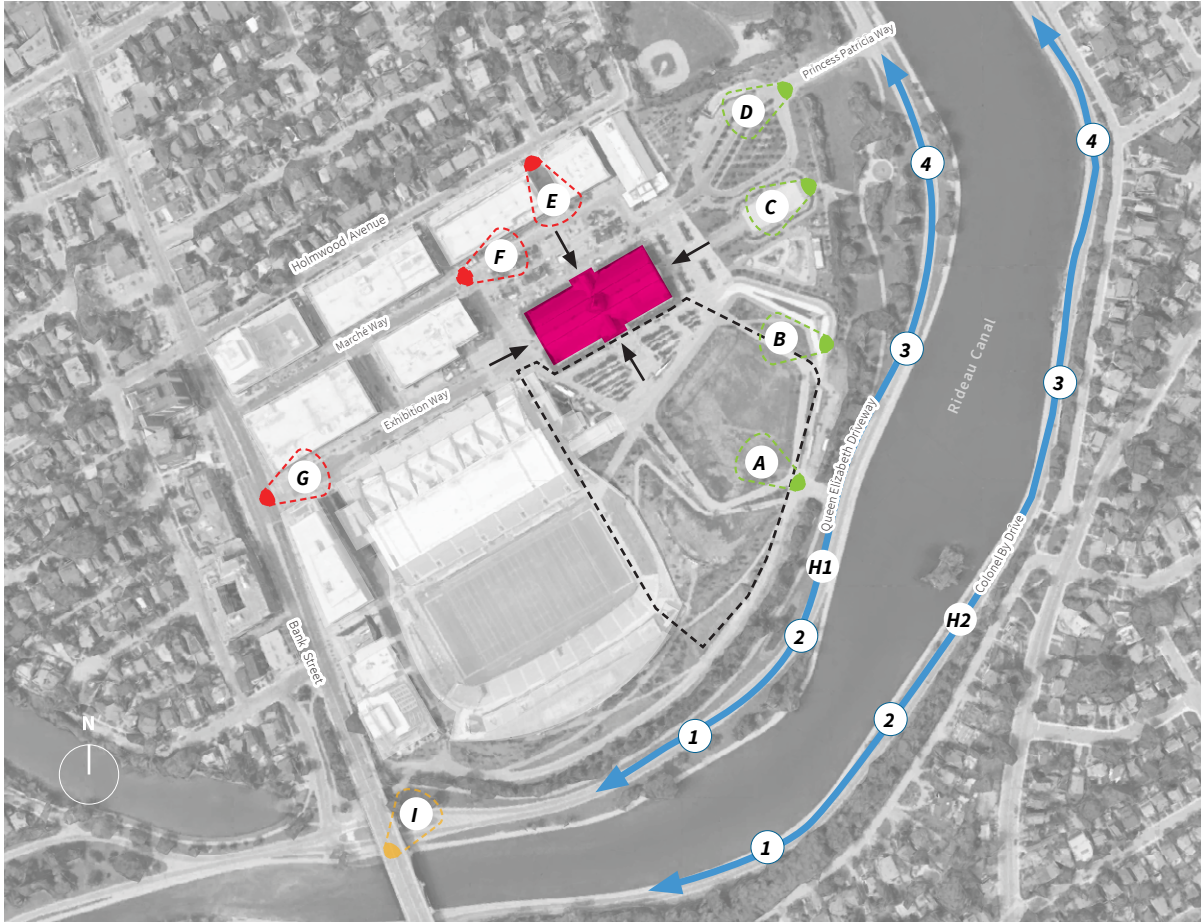

Map of considered viewpoints (Google Earth; annotated by ERA).

- Aberdeen Pavilion (Designated Part IV and NHS)
- Site
- Applicable views - These viewpoints are relevant to the scope of this HIA and are assessed in this report
- Non-applicable views - These viewpoints are positioned such that they are not impacted by the proposed Event Centre and do not require assessment
- Additional Views**
- Bank Street View
- Rideau Canal Views into Site
- Cost-Share Agreement (1993)**
- Protected Vista to Entry - These vistas align with HCEA Viewpoints A, C, E, G and have been incorporated into their assessment

3 PROPOSED DEVELOPMENT

3.1 Overview

The proposed development consists of a new, state-of-the-art, 5,500-seat Event Centre located adjacent to the eastern edge of TD Place Stadium. The Event Centre is oval-shaped, with softscaping on the south and east sides and hardscaping on the north side.

A sloped grassy berm is situated on the southeastern side of the Event Centre, with the Moving Surfaces public art installation relocated to the top of the berm. North of the berm are terraced seating walls leading up to the Event Centre.

To the east of the Event Centre, beyond the berm, the Great Lawn will be reshaped to extend closer to the Aberdeen Pavilion. The path geometry and shape of green spaces follow a curvilinear design.

NTD To be updated/coordinated for formal submission

3.2 Conservation Design Strategy

The following encapsulates ERA's perspective and understanding of the principles that should guide the redevelopment of the Site.

- 1** Protect and conserve significant views to the Aberdeen Pavilion.
- 2** Maintain the Aberdeen Pavilion as a landmark.
- 3** Ensure high-quality design for new construction that complements existing built resources.
- 4** Enhance the quality of place at Lansdowne Park with new year-round programming, activation and public amenities.
- 5** Consider opportunities for commemoration and interpretation across the Site to comprehensively highlight its cultural heritage significance and the narrative of its evolution over time.

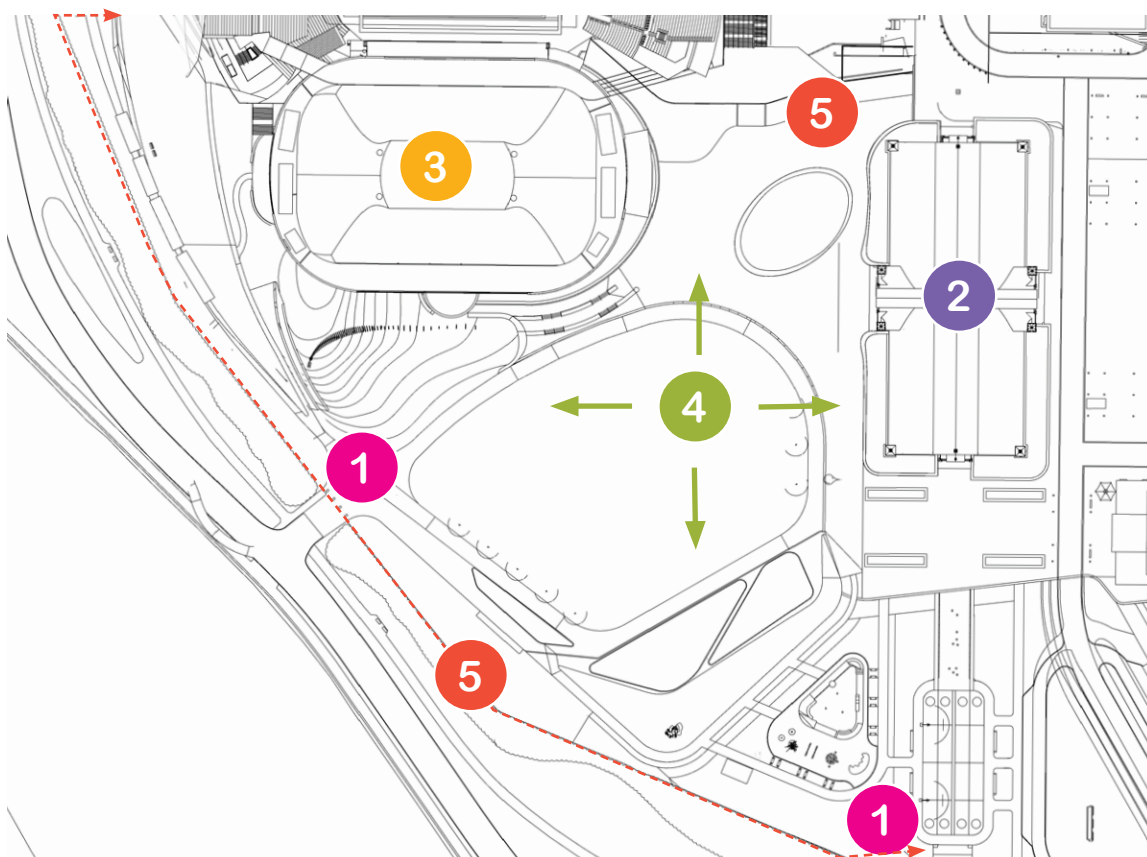

4 IMPACT ASSESSMENT

This section evaluates the impacts of the proposed Event Centre on the cultural heritage resources of and adjacent to Lansdowne Park, including the Aberdeen Pavilion and the Horticulture Building, as well as the adjacent and nearby cultural landscapes framing the Rideau Canal. It begins with an overall assessment of the proposed Event Centre on the aforementioned cultural heritage resources and, as directed by the Terms of Reference, proceeds with an in-depth assessment of the potential impact on the Aberdeen Pavilion and the surrounding public realm.

4.1 Overall Impacts Assessment

Horticulture Building

The proposed Event Centre does not present an impact on the Horticulture Building. The proposed Event Centre, located in the southwest quadrant of Lansdowne Park, and the Horticulture Building, situated in the northeast quadrant, are distinctly separated within the park. The proposed Event Centre retains the cultural heritage value of the Horticulture Building and does not impact the existing visual relationship between the Horticulture Building and the Aberdeen Pavilion.

Protected Cultural Landscapes

The proposed Event Centre does not present a direct impact on the adjacent cultural heritage resources of the Rideau Canal, QED and the Colonel By Drive cultural landscapes. The Rideau Canal and the QED are recognized by the HCEA as having a contextual relationship with Lansdowne Park and the proposed Event Centre does not present an adverse impact on this relationship. However, as the contextual value includes visibility of the Aberdeen Pavilion from the banks of the Rideau Canal, and by extension the QED and Colonel By Drive, the impact on these views is addressed in the following section.

4.2 Aberdeen Pavilion

4.2.1 Significant Views

Views from Within the Lansdowne Park

The HCEA identifies specific views (A-G), the Setting Lands, and the Framing Lands within Lansdowne Park as being of cultural heritage value. The placement of the proposed Event Centre in the southwest quadrant of Lansdowne Park ensures that there is no visual interference with Viewpoints E-G, which are located in the Setting Lands to the north, northwest and west of the Aberdeen Pavilion. Consequently, no further assessment is required for the impact on these three views.

The positioning of Viewpoints A-D, however, necessitates further assessment of impact. These views, which direct sight lines toward the Aberdeen Pavilion from the south, southeast and northeast, have the potential to capture the proposed Event Centre, and are analyzed on the following pages.

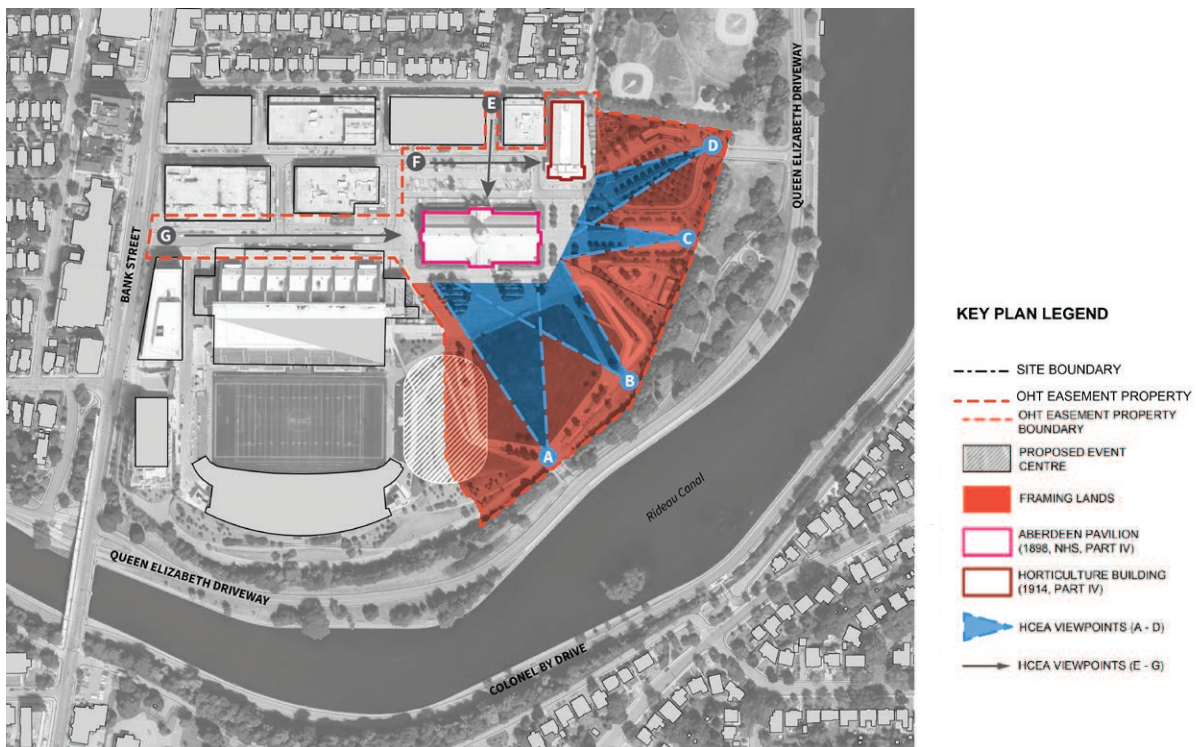

Aerial map depicting the HCEA Viewpoints (ERA, 2024).

View A: View of the Aberdeen Pavilion from Framing Lands (HCEA)



Existing condition of Viewpoint A.



Proposed condition of Viewpoint A. The visibility of the Aberdeen Pavilion is not impacted as the proposed Event Centre is situated outside the view cone, with the foreground left unobstructed. While only a small segment of the new berm and landscape, highlighted in pink, is visible on the far left (west), the overall view from the south may be impacted with the introduction of the Event Centre at the periphery.

View B: View of the Aberdeen Pavilion from Framing Lands (HCEA)



Existing condition of Viewpoint B.



Proposed condition of Viewpoint B. The condition of Viewpoint B remains unchanged: The proposed Event Centre is not visible and has no impact on the view.

View C: View of the Aberdeen Pavilion from Framing Lands (HCEA)



Existing condition of Viewpoint C.



Proposed condition of Viewpoint C. The visibility of the Aberdeen Pavilion is not impacted as the proposed Event Centre is primarily located outside the view cone. The small section that is visible (outlined in pink) appears in an area where other structures are already visible.

View D: View of the Aberdeen Pavilion from Framing Lands (HCEA)



Existing condition of Viewpoint D.



Proposed condition of Viewpoint D. The visibility of the Aberdeen Pavilion remains intact; however, the proposed Event Centre (outlined in pink) will be partially visible to the left (south) of the Pavilion, resulting in a minor adverse impact on the overall view.

The Event Centre has been strategically positioned and designed to protect the views towards the Aberdeen Pavilion, particularly from the south. As a result, only minor visual impact is anticipated, particularly from Viewpoints A and D as the Event Centre will encroach somewhat into the field of view. In Viewpoint A, while the foreground is protected and unobstructed the introduction of the Event Centre to the west will alter this perspective. In Viewpoint D, the Event Centre will be somewhat visible beyond the Aberdeen Pavilion, though its visibility will be somewhat obscured by foliage.

Dynamic Views and Bank Street View

While the HCEA viewpoints offer views from within Lansdowne Park, the scoped Terms of Reference for this report requires an assessment on additional views of the Aberdeen Pavilion from outside Lansdowne Park, including from the Rideau Canal, QED, Colonel By Drive, and Bank Street.

While there will be some adverse impact on certain contextual views of the Aberdeen Pavilion, particularly from the southern perspectives

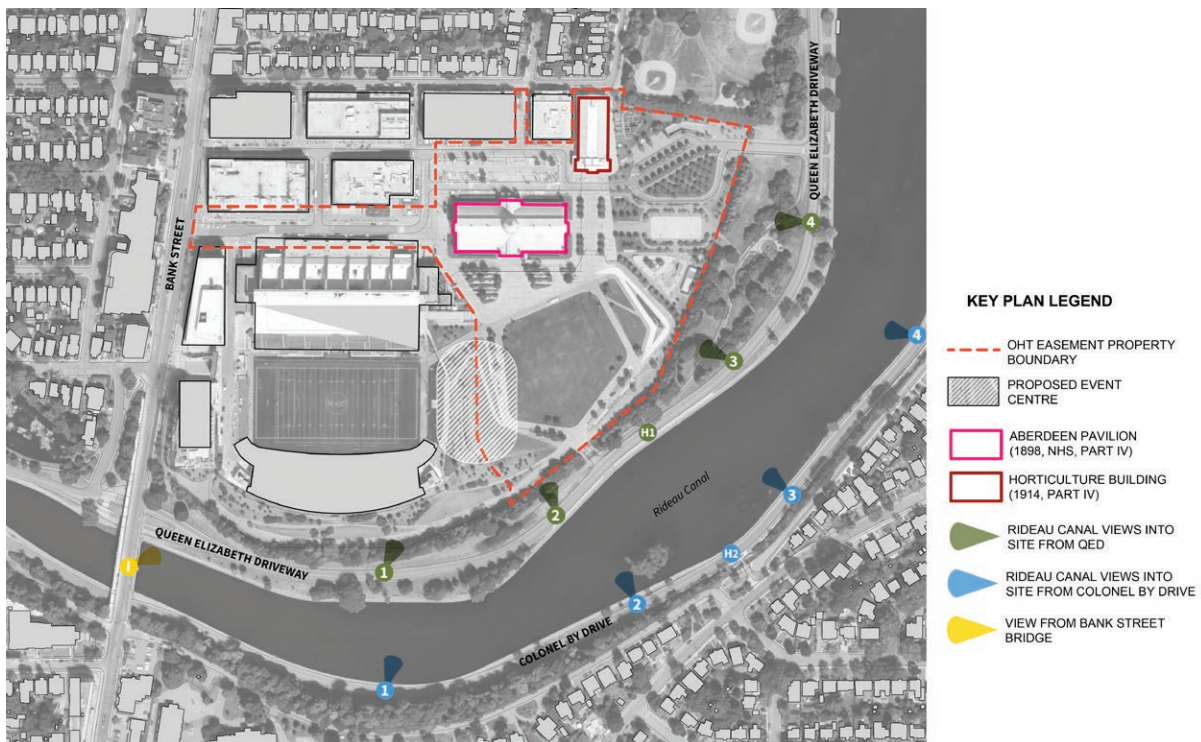

Aerial map depicting the additional considered views (ERA, 2024).

along Queen Elizabeth Driveway (Viewpoints H1.1 and H1.2), our assessment shows that the impact is minimal. The views from Queen Elizabeth Driveway and Colonel By Drive, which intermittently reveal the Aberdeen Pavilion through breaks in vegetation and at driveways, are not consistently clear, and the minimal encroachment of the Event Centre on the peripheries of these views does not present a significant impact.

Additionally, much of the foliage obstructing the views from the Canal is coniferous, meaning it obstructs views year-round, both in winter and summer. This consistent obstruction further mitigates the impact of the Event Centre on the views of the Aberdeen Pavilion.

There is no impact on the view of the Aberdeen Pavilion from Bank Street at Exhibition Way (HCEA Viewpoint G). The existing view from the Bank Street bridge towards Lansdowne Park is of the back side of TD Place and a parking lot. The Aberdeen Pavilion is not readily legible from this view, and the proposed Event Centre will not alter this condition.

View H1: View of the Aberdeen Pavilion from the Queen Elizabeth Driveway



View H1.1 existing condition.



View H1.1 proposed condition.



View H1.2 existing condition.



View H1.2 proposed condition.



View H1.3 existing condition.



View H1.3 proposed condition.



View H1.4 existing condition.



View H1.4 proposed condition.

View H2: View of the Aberdeen Pavilion from Colonel By Drive



View H2.1 existing condition.

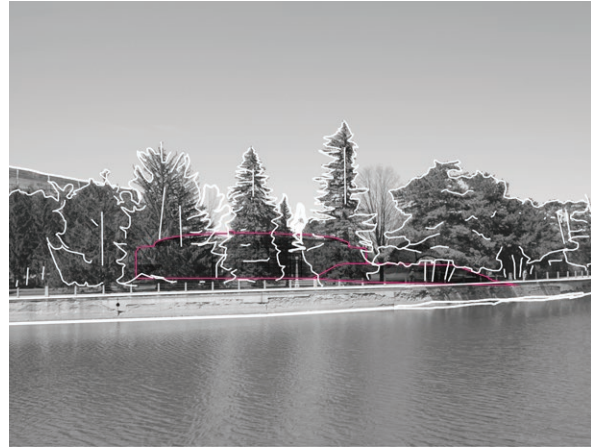

View H2.1 proposed condition.



View H2.2 existing condition.



View H2.2 proposed condition.



View H2.3 existing condition.



View H2.3 proposed condition.



View H2.4 existing condition.



View H2.4 proposed condition.

4.2.2 Public Realm

The proposed Event Centre presents four types of adverse impact on the public realm surrounding the Aberdeen Pavilion. An assessment of these impacts and their associated mitigation measures is provided below.

1. ENCROACHMENT ON FRAMING LANDS. The Framing Lands are identified in the HCEA as lands that provide the lateral context to the views of the Aberdeen Pavilion. Since the value and quality of the views are tied to open space, the Framing Lands are currently open and free of buildings and large structures. The introduction of a large structure (in the form of the proposed Event Centre) to a portion of these lands presents an adverse visual impact, altering the existing spatial and visual dynamic.

NTD Graphics to be added

Mitigation: To address the encroachment on the Framing Lands, the proposed Event Centre has been strategically sited to avoid impacting the (south) axial view of the Aberdeen Pavilion.

2. DECREASE IN OPEN PUBLIC SPACE. The shortening of the berm and the siting of the Event Centre on the Framing Lands result in a reduction of open public space in the southwest quadrant of Lansdowne Park. This represents an adverse impact on the quantity of space available. The original functions of the public areas, including the Great Lawn, Hill/Berm, and Great Porch, are maintained.

NTD Graphics to be added

Mitigation: The reduction in open public space is mitigated through design measures that enhance the opportunity for active use of areas within and surrounding the Event Centre. These measures include adding informal seating opportunities around the Event centre and integrating public restroom access. Additionally, the design retains the original intent of key public spaces such as the Great Lawn, Berm, and Great Porch, ensuring that these areas continue to serve their public recreational purposes.

3. INTRODUCTION OF A NEW DESIGN LANGUAGE. The proposed Event Centre and adjoining new landscape introduces a new curvilinear design language to the Site. The introduction of a new design language may present an adverse impact as it has the potential to affect the cohesion between the Aberdeen Pavilion and the remainder of Lansdowne Park, particularly the Framing Lands, and the Great Porch.

NTD Graphics to be added

Mitigation: The impact of this new design language can be mitigated by ensuring material continuity, including using the same or similar landscape materials, and ensuring a cohesive lighting, signage and

wayfinding program. As the proposed design moves forward and details of the subsequent development phases are defined, measures to ensure design cohesion within Lansdowne Park should be implemented.

4. LANDMARK STATUS AND ISOLATION. While the Aberdeen Pavilion maintains its role as a central feature of Lansdowne Park, the construction of the Event Centre introduces a new, significant architectural element to the Park. While the Event Centre does not inherently isolate the Aberdeen Pavilion, the introduction of a new built structure in such close proximity may alter the landmark status of the Aberdeen Pavilion as the “heart of the Park.”

Mitigation: The impact of the new building is mitigated through its positioning and relatively low height, which are intended to support the Pavilion’s status as a prominent landmark from most vantage points.

4.2.3 Construction Impacts

There is a low likelihood of construction-related impacts from the Event Centre that would cause physical damage to the Aberdeen Pavilion. Nonetheless, appropriate construction measures and safeguards should be implemented to ensure ongoing protection.

5 CONSERVATION STRATEGY & FURTHER MITIGATION

The proposed conservation strategy is rehabilitation. As part of the June 2023 HIA, ERA prepared a set of Conservation Design Parameters to help guide the design of new construction and mitigate the impacts on the existing and evolving cultural heritage value of Lansdowne Park.

The Conservation Design Parameters relevant to the Site are:

- 1) Prioritize the pedestrian experience at ground level between future development and the Aberdeen Pavilion;
- 2) Integrate new event centre, berm and public art sculpture with the Great Lawn, while protecting views to the Aberdeen Pavilion; and
- 3) Explore opportunities to enhance pedestrian access and interface of the Site and the Rideau Canal along the south-eastern edge.

An assessment of the applicable Conservation Design Parameters is provided on the following pages.

Rehabilitation: *the action or process of making possible a continuing or compatible contemporary use of an historic place, or an individual component, while protecting its heritage value.*

Restoration: *the action or process of accurately revealing, recovering or representing the state of an historic place, or of an individual component, as it appeared at a particular period in its history, while protecting its heritage value.*

Preservation: *the action or process of protecting, maintaining, and/or stabilizing the existing materials, form, and integrity of a historic place or of an individual component, while protecting its heritage value.*

Source: Standards and Guidelines for the Conservation of Historic Places in Canada (2010).

NTD: UPDATE ALL GRAPHICS, PLANS AND RENDERINGS WITH FINAL DESIGN

1 Prioritize the pedestrian experience at ground level between future development and the Aberdeen Pavilion

- Explore opportunities to improve potential vehicular and pedestrian conflict at the southwest corner of the Aberdeen Pavilion
- Consider at-grade pavement selection and pedestrian markings to clearly delineate uses and minimize congestion
- Locate loading and turning radius within the new buildings
- Ensure adequate protection of the adjacent Aberdeen Pavilion during construction

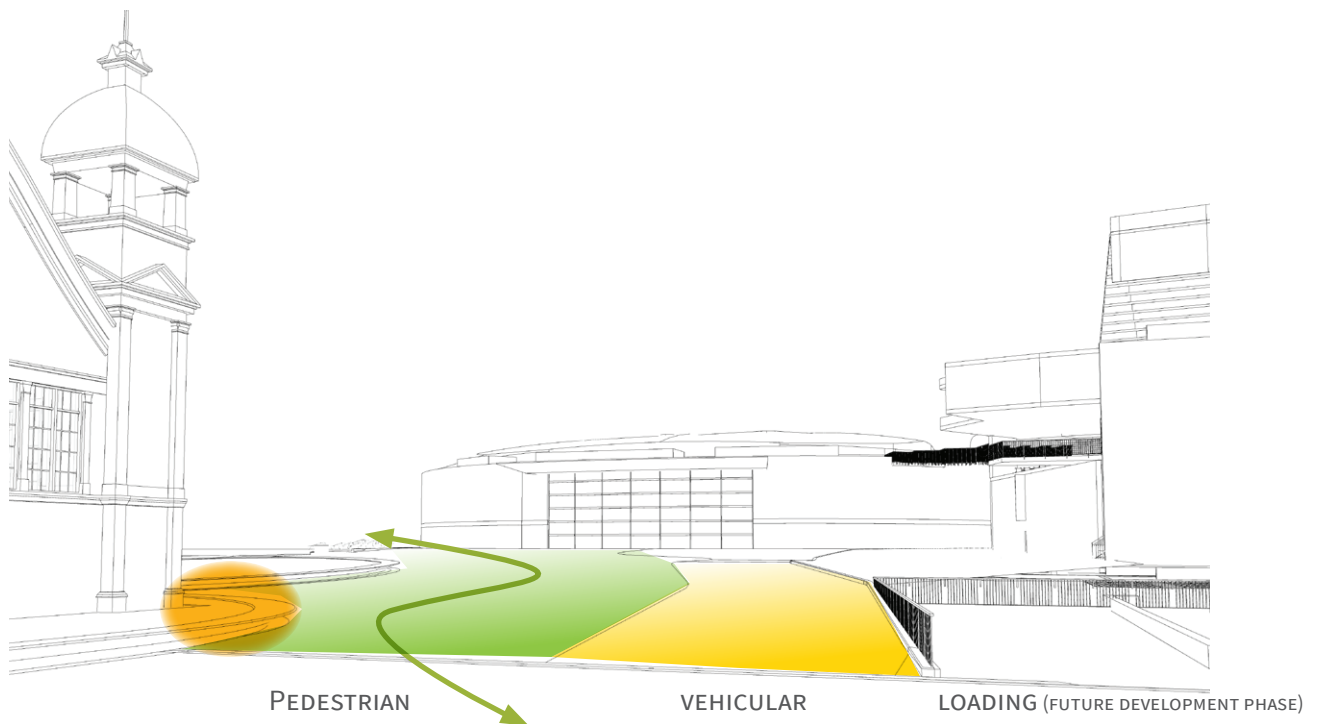

Discussion

The proposed development and adjoining landscape design effectively separates vehicular and pedestrian uses at the southwest corner of the Aberdeen Pavilion. Careful consideration has been given to ensuring the clear delineation of uses with the implementation of pedestrian markings and design measures to separate pedestrian and vehicular traffic. While a small portion of the perimeter plantings at the southwest corner of the Aberdeen Pavilion will be altered to allow for new pedestrian access, the impact is minimal.

A Protection Plan is recommended as a condition of approval to ensure the adequate protection of the adjacent Aberdeen Pavilion during construction.

NTD: UPDATE ALL GRAPHICS, PLANS AND RENDERINGS WITH FINAL DESIGN

2 Integrate new event centre, berm and public art sculpture with the Great Lawn, while protecting views to the Aberdeen Pavilion

- Design the new berm and event centre to fit in with the landscape and integrate as much public access and green planting (green roof) as possible
- Explore opportunities to align new pedestrian walkways and landscaped areas of the Great Lawn to showcase views to the Aberdeen Pavilion
- Relocate Jill Anholt’s Moving Surfaces public art sculpture near to its existing location in a position that does not compromise views to the Aberdeen Pavilion from the south

A Viewpoint A

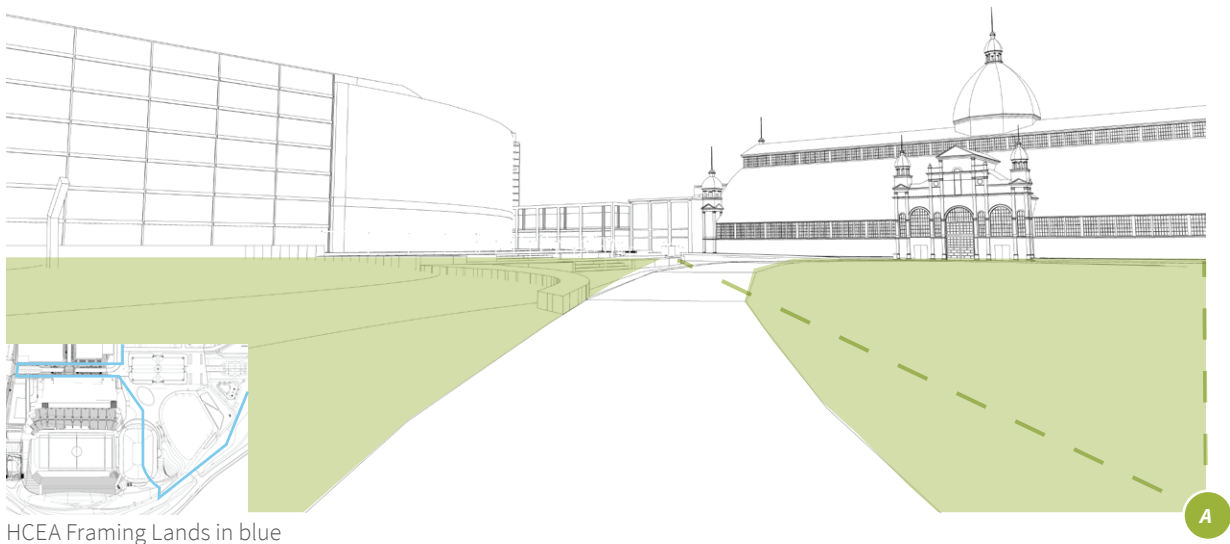

HCEA Framing Lands in blue

Discussion

The analysis of impacts of the proposed Event Centre on the views of the Aberdeen Pavilion and on the public realm are discussed in 4.2.1 and 4.2.2. The proposed relocation of the Moving Surfaces public art sculpture places it in a proximate position that does not compromise views of the Aberdeen Pavilion from the south.

Future mitigation strategies include enhancing the “greening” of the Event Centre’s interface with the Great Lawn to promote a more integrated appearance. Further consideration should also be given to ensure overall design cohesion with the existing landscape, considering elements such as pavement, signage, lighting and wayfinding to maintain aesthetic and functional continuity.

NTD: UPDATE ALL GRAPHICS, PLANS AND RENDERINGS WITH FINAL DESIGN

3 Explore opportunities to enhance pedestrian access and interface of the Site and the Rideau Canal along the southeastern edge

- Enhance the interface of the Site and the adjacent cultural landscapes along the Rideau Canal
- Create a “soft edge” with designed public access points
- Minimize signage and urban condition along the southern edge of the Site

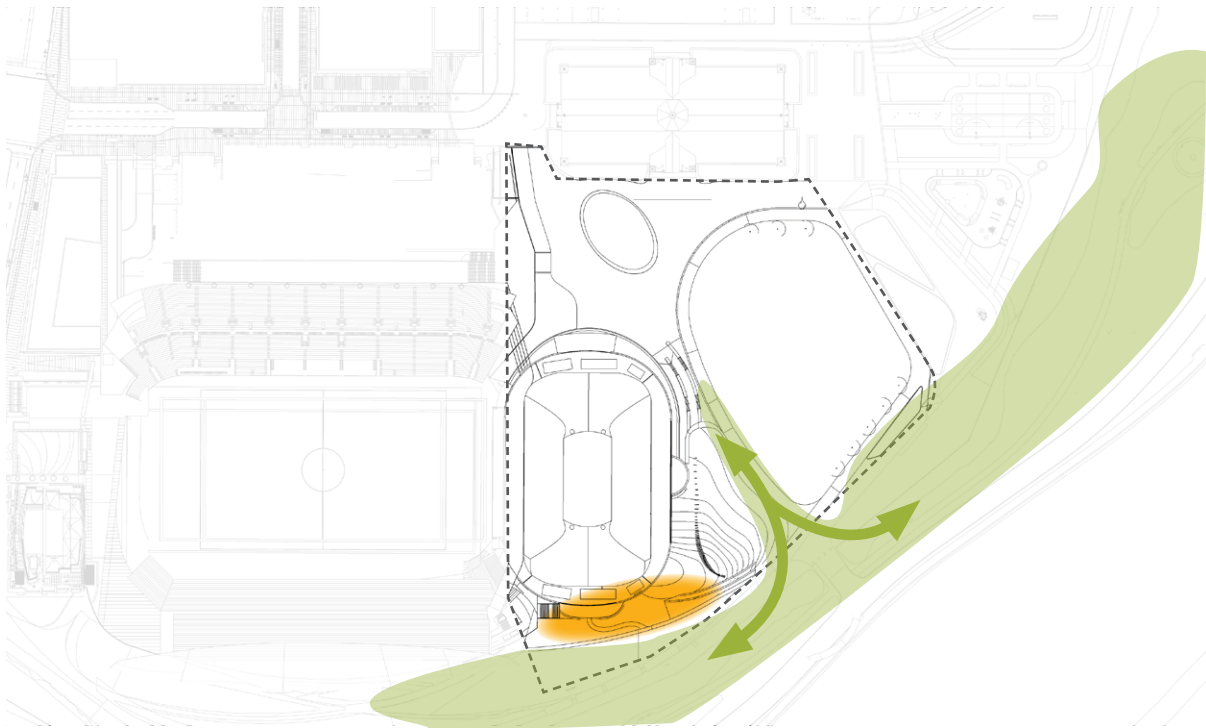

Discussion

While there is some minor visual impact from certain dynamic viewpoints along the Rideau Canal (see 4.2.1), the green edge along the southeastern edge of the Site is maintained with minimal changes proposed. A public access point has been integrated into the site plan, allowing for enhanced pedestrian access.

Recommendations for further mitigation include softening the edge at the back (south) of the Event Centre to better integrate it into the surrounding environment.

6 PRELIMINARY LIGHTING, SIGNAGE AND INTERPRETATION CONSIDERATIONS

6.1 Lighting

It is recommended that a Heritage Lighting Plan be prepared that describes general principles and guidelines for illumination of the Site, such as the hierarchy, direction, levels and locations of new lighting, in consideration of, and commensurate with, the significance of heritage resources on the Site.

At a high-level, the Lighting Plan should consider the following principles:

- Illumination of the Site should be thoughtful and strategic, and should not be continuous and uniform across space and time.
- Lighting should follow environmental best practices, with consideration given to impacts to wildlife, specifically as it relates to the use of up-lighting and contributing to ambient light pollution.
- Lighting should be well integrated with the existing site to ensure visual coherence, with careful consideration given to the location, intensity, and temperature of new lighting installations.
- New lighting should create a clear hierarchy of illumination, showcasing and reinforcing the primacy of key views and moments (such as the Aberdeen Pavilion), while reducing the primacy of subordinate site elements such as parking, servicing, etc.
- New lighting should not overwhelm illumination of views, features, places and symbols of historic significance (such as the Aberdeen Pavilion) or national importance (such as the Rideau Canal).
- Lighting should avoid, to the extent possible, contributing to ambient illumination to the adjacent Rideau Canal.
- All lighting should follow municipal and federal policy and guidelines.

6.2 Signage

It is recommended that a Heritage Signage Plan be prepared that assesses the exterior building signage requirements and provides recommendations for the site-wide implementation, design, composition and locations for the signage throughout the Site.

In general, the Signage Plan should consider the following principles:

- Signs should present information that is clear, simple, and accessible for all users to view and understand, with text information provided in both English and French languages.
- Where possible, preference should be given to conveying information through discreet design cues, such as familiar navigation symbols and icons imprinted or etched on surfaces.
- Signage installations should be kept to a minimum, as required for the site context, with information consolidated to the fewest instances, where appropriate, to reduce visual clutter.
- Signage should be integrated with existing site signage to ensure that together, they form a clear and cohesive system with a common look and feel.
- Signage should not impede, distract from, or clutter key views, such as those of the Aberdeen Pavilion.
- Signage should be installed in strategic locations where they are easily visible to users while not obstructing or impeding movement through or around the site.
- Signage should be constructed of high-quality materials and finishes, while also minimizing the need for maintenance or replacement.
- Signage design should reinforce the character and sense of place through the thoughtful selection of content, location, and materiality.
- Signage, especially where visible from the south and east perimeter of the Site, adjacent to the Rideau Canal, should not include any internal illumination, such as “lightbox”, “cabinet” or “front lit-channel” signs.

6.3 Interpretation

It is recommended that a Heritage Interpretation Plan be prepared that describes strategies to interpret and commemorate the significance of heritage resources on the Site. The report should provide recommendations for the implementation, strategies, and methods of presentation and potential locations for the interpretation of the Site.

In general, the Interpretation Plan should consider the following principles:

- Interpretive elements should consider the unique and diverse historic values of the Site, and commemorate lost features or attributes of significance.
- Key themes, narratives, or other interpretive content should be considered and identified prior to the development of interpretive design elements to ensure that together, they form a compelling and complete composition, rather than disparate and disconnected messaging.
- Themes for interpretation of the Site should build on the existing *Lansdowne Heritage and Algonquin Interpretation and Public Art Implementation Plan (2012)* and the Council-endorsed *Lansdowne Partnership Sustainability Plan and Implementation Report (2022)*.
- Interpretation of the site values should be considered as part of the design process, identifying opportunities to convey interpretative themes and narratives, whether explicit, abstracted, or referential, throughout the proposed design. This may include using materiality that references the Site's history, interpretive plaques or panels that encourage users to learn about the Site, or integration of public art or symbols connected to the area's rich and diverse history.
- Interpretive panels, plaques, or other installations should be integrated with the look and feel of existing interpretative elements installed at the Site. This includes the location, the design of interpretive elements, and composition of narratives, themes, and information.

- Large-scale elevations, or other blank or predominantly unadorned surfaces, visible from the public realm (such as the east elevation of proposed event centre), should be considered for featuring interpretive art.

7 NEXT STEPS

The following reports are recommended as the development process moves forward. Additional heritage studies may be requested by City staff.

Heritage Interpretation Plan

A Heritage Interpretation Plan identifies an approach and strategy for communicating key heritage themes in the context of redevelopment. The recommendations for interpretation of the Site should build on the existing Lansdowne Heritage and Algonquin Interpretation and Public Art Implementation Plan (2012) and the Council endorsed Lansdowne Partnership Sustainability Plan and Implementation Report (2022).

Heritage Lighting Plan

A Heritage Lighting Plan establishes a strategy for site illumination that respects and enhances the significance of on-site and adjacent heritage resources. The recommendations for lighting should be based on the guidelines detailed in Section 6.1, ensuring that each lighting solution enhances the visual and historical integrity of the Site.

Heritage Signage Plan

A Heritage Signage Plan establishes a strategy for exterior site signage. The recommendations for signage should be based on the guidelines detailed in Section 6.1, ensuring that each signage solution enhances the visual and historical integrity of the Site.

Heritage Protection Plan

A Heritage Protection Plan ensures the appropriate conservation of on-site and adjacent heritage buildings during construction work. The Protection Plan should include a detailed plan for protection and mitigation of risk of the Aberdeen Pavilion during construction. The Protection Plan should include:

- Pre-construction building condition survey and documentation;
- Vibration and crack monitoring;
- Implementation of physical protection for the designated building;
- Management of construction dust, debris etc.; and
- Post-construction building condition survey and documentation.

8 CONCLUSION

The proposal conserves the cultural heritage value of the Site by maintaining views to its significant buildings, preserving the setting of the Aberdeen Pavilion, and appropriately mitigating potential impacts on its heritage value. The proposal also allows for the evolution of the Site to accommodate a new standalone Event Centre.

The proposed Event Centre has been designed and situated to minimize impact on the protected HCEA and Parks Canada Cost-Share Agreement views, the Setting and Framing Lands, the Aberdeen Pavilion, and the Horticulture Building. While the impact on views of the Aberdeen Pavilion is minimal, the introduction of a large structure to the Framing Lands alters the existing condition and decreases the extent and alters the character of the public open space at the southwest quadrant of the Site.

The proposed Event Centre introduces a new, significant architectural element to Lansdowne Park. While the Event Centre does not inherently isolate the Aberdeen Pavilion, the introduction of a new built structure in such close proximity may alter the landmark status of the Aberdeen Pavilion as the “heart of the Park.”

Mitigation measures to minimize the adverse impacts include the siting, placement, and relatively low height of the proposed Event Centre, and design measures that enhance the usability of areas within and surrounding the proposed building while retaining the original intent of key public spaces.

Further mitigation is encouraged to ensure overall design cohesion throughout subsequent phases of the Lansdowne 2.0 development process. Additional detailed studies are recommended, including a Heritage Interpretation Plan, Heritage Lighting Plan, and Heritage Protection Plan.

DRAFT

APPENDIX A: REFERENCES

APPENDIX A: REFERENCES

- City of Ottawa. 1984. By-law Number 22-84 [Aberdeen Pavilion heritage designation].
- City of Ottawa. 1994. By-Law 8-94 [Horticultural Building heritage designation].
- City of Ottawa. 2012. Heritage Conservation Easement Agreement [Lansdowne Park]. Ottawa; City of Ottawa.
- City of Ottawa. 2012. Lansdowne Heritage and Algonquin Interpretation and Public Art Implementation Plan.
- City of Ottawa. 2012. Lansdowne Partnership Plan, 2012.
- City of Ottawa. 2021. City of Ottawa Official Plan. <<https://ottawa.ca/en/planning-development-and-construction/official-plan-and-master-plans>>
- City of Ottawa. 2022. Lansdowne Partnership Sustainability Plan and Implementation Report.
- City of Ottawa Archives, n.d. <<https://ottawa.ca/en/arts-heritage-and-events/city-ottawa-archives>>
- Commonwealth Historic Resource Management Limited. 2012. Lansdowne Park: Statement of Cultural Values and Heritage Impact Assessment.
- Department of Canadian Heritage. 1993. [Aberdeen Pavilion Cost Share Agreement]. Ottawa: Canadian Heritage.
- Dillon Consulting Limited. 2012. Rideau Corridor Landscape Strategy. Gatineau: Parks Canada.
- ERA. 2023. Lansdowne Park: Heritage Impact Assessment.
- Heritage Ottawa, n.d. <<https://heritageottawa.org/>>
- National Capital Commission. 2007. Canada's Capital Views Protection: Protecting the Visual Integrity and Symbolic Primacy of Our National Symbols. Ottawa: National Capital Commission.
- National Capital Commission. 2009. Urban Lands Master Plan Rideau Canal Corridor Visual Assessment 2009. Ottawa: National Capital Commission.
- National Capital Commission. 2017. The Plan for Canada's Capital, 2017–2067. ISBN 978-0-660-08220-2 (PDF). Ottawa: National Capital Commission.
- National Capital Commission. 2020. Draft NCC Parkways Policy. Ottawa: National Capital Commission.
- National Capital Commission. 2022. Heritage Inventory: Queen Elizabeth Driveway. Ottawa: National Capital Commission.

- National Capital Commission. 2023. Working with Cultural Landscapes: A Guide for the National Capital Region. Ottawa: National Capital Commission.
- Ontario Ports and Entertainment Group. 2022. Lansdowne 2.0: Proposal to the Finance and Economic Development Committee.
- Parks Canada. 2005. Canadian Register of Historic Places: Aberdeen Pavilion National History Site of Canada. <<https://www.historicplaces.ca/en/rep-reg/place-lieu.aspx?id=4114>>
- Parks Canada. 2005. Rideau Canal World Heritage Site Management Plan. Gatineau: Parks Canada.
- Parks Canada. 2005. Rideau Canal National Historic Site of Canada Management Plan. Gatineau: Parks Canada. <<https://www.historicplaces.ca/en/rep-reg/place-lieu.aspx?id=4114>>
- Parks Canada. 2007. Canadian Register of Historic Places: Rideau Canal National Historic Site of Canada. <<https://www.historicplaces.ca/en/rep-reg/place-lieu.aspx?id=5727>>
- Parks Canada. 2008. Canadian Register of Historic Places: The Horticulture Building, 957, Bank Street, Ottawa. <<https://www.historicplaces.ca/en/rep-reg/place-lieu.aspx?id=8445&pid=0>>
- Parks Canada. 2010. Standards and Guidelines for the Conservation of Historic Places in Canada, ISBN 978-1-100-15953-9. Gatineau: Parks Canada.
- Parks Canada. 2010. Parks Canada's Guiding Principles for the Redevelopment of Lansdowne Park (Ottawa, Ontario): Protecting Heritage Values, Promoting Public Understanding, and Creating Opportunities for Visitor Experience. Gatineau: Parks Canada.
- UNESCO World Heritage Centre, n.d. Rideau Canal. <https://whc.unesco.org/en/list/1221/>

DRAFT

APPENDIX B: SCOPED TERMS OF REFERENCE

Lansdowne 2.0 - Re-Zoning - March 2024

Event Centre Site Plan: Scoped Heritage Impact Assessment

Prepared by: Anne Fitzpatrick (City of Ottawa), Heather Thomson (NCC), Jennifer Drew (Indigenous Affairs and Cultural Heritage Directorate, Parks Canada), Jamie Joudrey (Ontario Heritage Trust), Graham Forster (Ontario Heritage Trust)

1.0 Summary

This Heritage Impact Assessment (HIA) will focus on the Site Plan for the Event Centre at Lansdowne Park. The HIA will be considered jointly by the City, the National Capital Commission (NCC) and the Ontario Heritage Trust (OHT) and Parks Canada in their review of the proposal.

The HIA should be prepared according to the City of Ottawa's ["A Guide to Preparing Heritage Impact Assessments"](#)

2.0 Event Centre Background and Planning Permissions

Background

In November 2023, City Council granted approval to proceed to the next stage of planning for Lansdowne 2.0 through the approval of the report entitled *2023 Lansdowne Partnership Plan – Authorization to Proceed to the Next Steps in the Redevelopment Report* ([ACS2023-PIE-GEN-0009](#)). The Council decision resulted in the following *Concept Plan* approvals:

1. A new, state-of-the-art, 5,500 seat Event Centre;
2. New North Stadium Stands with 11,200 seats;
3. Two residential, mixed-use buildings, up to 40 stories in height along the south side of Exhibition Way within the City's air and subterranean property rights parcel;
4. New retail of up to 49,000 square feet within the podium of the air rights parcel; and
5. City-public realm enhancements.

Planning Permissions

The Event Centre required a Zoning By-law (ZBLA) and Official Plan Amendment (OPA) to permit the use and location. The City Staff report to Council was approved on November 9th (but subsequently appealed to the Ontario Land Tribunal (OLT)). In brief, the ZBLA and OPA approvals included the following approvals:

As it pertains to the amendment to the City's Official Plan:

- Permit the Event Centre within the established areas of greenspace and public space within the Lansdowne Special District (basically allowing the Event Centre's proposed location); and
- Permit an Event Centre within the Lansdowne Special District (being the Policy designation in our Official Plan)

As it pertains to the amendment to the City's Zoning By-law:

- The application was to also to permit the land-use of the new Event Centre within the new location for this building; to permit a 15.5 metre height permission for the Event Centre; to establish a 138 metre height permission (40 storeys) for the residential towers; and other details pertaining to zoning performances and standards.
- A holding provision was proposed until such time as further Heritage analysis was conducted on the design of the Event Centre as it relates to the Aberdeen Pavilion in consultation with the Ontario Heritage Trust

3.0 Event Centre Site Plan Application

City Staff will proceed with internal development of the site plan application and its supporting plans and studies to advance the pre-submission development of matters including, but not limited to:

- Design of the interface of the Event Centre and Great Lawn, including public engagement on these public realm areas
- Design of the public plaza entrance to the Event Centre adjacent to Exhibition Way and the Aberdeen Pavilion
- Reinstatement and relocation of the art installation 'Moving Surfaces'
- Heritage and design considerations related to the design of the Event Centre and the Aberdeen Pavilion.
- Agency consultation with the National Capital Commission, Ontario Heritage

Trust, and Parks Canada

- Internal review of the supporting plans and studies
- Pre-consultation with the City's Urban Design Review Panel (UDRP)
- Review by the City's Accessibility Advisory Committee (AAC)

The site plan application will be formally submitted for review and approval following an OLT decision on the ZBLA and OPA and should that decision permit the new Event Centre. A part of the site, which includes the Aberdeen Pavilion and Horticulture Building, is subject to a 2012 Heritage Conservation Easement Agreement between the City of Ottawa and the Ontario Heritage Trust, with the purpose of conservation of cultural heritage resources on the site. The Easement Agreement includes protected view corridors, and delineated framing and setting lands.

The proposed event centre and the relocated berm will encroach into the framing lands, which will require permission from the Ontario Heritage Trust through an Alteration Request to be submitted with the Site Plan Control Application.

Any archaeological investigations and/or monitoring will be in accordance with Ministry of Citizenship and Multi-culturalism guidelines and will also require permission from the Ontario Heritage Trust.

4.0 Existing Heritage Context

Lansdowne Park is the former Central Canada Exhibition Association (CCEA) fairground (1888 – 2009). The Park is bounded by Bank Street to the west, Holmwood Avenue to the north, and the Queen Elizabeth Driveway (QED) and the Rideau Canal National Historic Site of Canada, Canadian Heritage River and UNESCO World Heritage Site to the east and south. The site features the following cultural heritage resources:

- The Aberdeen Pavilion was constructed in 1898 and was designed by Moses C. Edey and the Dominion Bridge Company. It was designated a National Historic Site in 1983, designated municipally (By-law 22-84) in 1984 under Part IV of the Ontario Heritage Act (OHA), and is subject to an easement agreement under Section 22 of the OHA (2012) between the City of Ottawa and the Ontario Heritage Trust (OHT)
- The Horticulture Building was constructed in 1914 and designed by Francis Sullivan. Designated municipally (By-law 8-94) in 1994 under Part IV of the OHA.

This building is also subject to the OHT easement, including portions of the interior.

- Frank Clair Stadium/Civic Centre was constructed in 1966-67 and designed by Gerald Hamilton & Associates and the Dominion Bridge Company. The south bleachers constructed in 1975 have been demolished.

Cultural heritage features adjacent to the site include:

- The Rideau Canal, which is the only canal dating from the great North American canal-building era of the early 19th century that remains operational along its original line with most of its original structures intact. It is distinguished as a UNESCO World Heritage Site, a national historic site of Canada, and a Canadian Heritage River.
- Queen Elizabeth Driveway is a cultural landscape of Capital value. Originally called the Rideau Canal Driveway, it was one of the first projects of the Ottawa Improvement Commission (OIC), today the NCC, which aimed to create a more beautiful city and develop and promote Ottawa's identity as the capital of Canada. It also provides an historic setting for a large section of the Rideau Canal National Historic Site of Canada and World Heritage Site in the central part of Ottawa. For over a century, the Driveway has contributed to the aesthetic, historic, recreational, and cultural fabric of the city.
- Colonel By Drive, a scenic parkway on the east side of the Rideau Canal, was developed by the National Capital Commission in the 1960s following removal of the rail lines. Like the Queen Elizabeth Driveway, it is a cultural landscape of Capital value, contributes to the aesthetic and recreational values of the Rideau Canal, and acts as a scenic entry to the Capital Core. It features significant views toward Lansdowne Park.

5.0 Heritage Impact Assessment

The Event Centre component of Lansdowne 2.0 has the potential to impact the cultural heritage value of Lansdowne Park. The following items should be considered and addressed as part of the HIA:

- An overall assessment of the impacts of the event centre on the cultural heritage resources of Lansdowne Park. This includes the Aberdeen Pavilion, the Horticulture Building and the adjacent resources of the Rideau Canal and the Queen Elizabeth Driveway, and Colonel By Drive cultural landscapes.

- Assessment of potential impacts of the event centre on the Aberdeen Pavilion including but not limited to:
 - Obstruction or diminishment of significant views of the Aberdeen Pavilion
 - Impacts on the public realm surrounding the Aberdeen Pavilion, which frame the site
 - Isolation of the Aberdeen Pavilion from its surrounding environment in ways that would affect the access to or user/visitor experience of the site
 - Potential construction impacts that could cause physical damage to the buildings
 - Potential impact on the Aberdeen Pavilion as a defining landmark of the site
 - Identify mitigative measures for the design to reduce any identified impacts
- Assessment of the impact of the event centre on the views of the Aberdeen Pavilion. Consideration should be given to the views:
 - Defined in the Ontario Heritage Trust Easement
 - Defined in the Aberdeen Pavilion Cost-Share Agreement, 1993
 - From the Rideau Canal
 - From Bank Street
 - From Queen Elizabeth Driveway and Colonel By Drive, especially impacts to high quality views identified in the NCC 2009 Rideau Canal Visual Assessment.
- Application of the *Standards and Guidelines for the Conservation of Historic Places in Canada*, including Chapter 4.0 Cultural Landscapes.
- Development of a Mitigation Strategy
 - Identify key mitigative measures that should be implemented;
 - Identify preferred options from massing models that are provided;
 - Identify opportunities to enhance cultural heritage resources on the site;
 - Identify potential public realm enhancements that might enhance the heritage resources;
- Consider the Conservation Design Parameters identified in the Lansdowne 2.0 Heritage Impact Assessment, which included:
 - Integrate new event centre, berm and public art sculpture with the Great Lawn, while protecting views to the Aberdeen Pavilion

- Explore opportunities to enhance pedestrian access and interface of the Site and the Rideau Canal along the southeastern edge
- Identify interpretations opportunities for the event centre to enhance and promote the cultural heritage value of Lansdowne Park through the public realm design, landscape plan, interpretation plan, and lighting plan.

6.0 Supporting Material

- Statement of Cultural Heritage Values and Heritage Impact Assessment: Lansdowne Park, Commonwealth Historic Resource Management Limited.
- Ontario Heritage Trust Easement: 2012
- Statement of Cultural Heritage Value, Designating By-Laws. Aberdeen Pavilion and Horticulture Building
- Lansdowne 2.0 Materials: Massing models, renderings, site plan, transportation studies, wind studies
- Condition Assessments of the Aberdeen Pavilion, Stantec 2020
- Aberdeen Pavilion Cost-Share Agreement, 1993 and its Appendix A Conservation Report (On-Site Investigation Report, 1988, Blood, Hughes, Marshall Architects; Aberdeen Pavilion Conservation Report, 1990, Thomas E. Blood, Architect; Supplementary Report, 1992, Julian Smith)
- Parks Canada's Guiding Principles for the Redevelopment of Lansdowne Park (Ottawa, Ontario): Protecting Heritage Values, Promoting Public Understanding, and Creating Opportunities for Visitor Experience, February 10, 2010
- Parks Canada Rideau Canal National Historic Site Management Plan? (newly tabled)
- Rideau Canal World Heritage Site Management Plan, UNESCO World Heritage Site, Parks Canada, 2005. Online at: <https://www.pc.gc.ca/en/lhn-nhs/on/rideau/histoire-history/pm-we>.
- National Capital Commission Heritage Inventory Sheets:
 - Rideau Waterway
 - Queen Elizabeth Driveway
 - Colonel By Drive
- Edwinna von Baeyer, "The Cultural Landscape of the Queen Elizabeth Driveway, Ottawa, from 1826 to 2002," Report for the NCC, 2002.
- Rideau Canal Visual Assessment 2009, NCC.
- *Working with Cultural Landscapes – A Guide for the National Capital Region* (NCC, Jan 2023)

- Rideau Canal, UNESCO World Heritage Convention. Online at <https://whc.unesco.org/en/list/1221/>, assessed 5 August 2022.
- Rideau Canal National Historic Site of Canada, Directory of Federal Heritage Designations, Parks Canada. Online at https://www.pc.gc.ca/apps/dfhd/page_nhs_eng.aspx?id=503, assessed 5 August 2022. 3.
- Rideau Waterway, Canadian Heritage Rivers System. Online at <https://chrs.ca/en/rivers/rideau-waterway>, assessed 5 August 2022.
- *The Standards and Guidelines for the Conservation of Historic Places in Canada* (Parks Canada, 2012)
- National Capital Commission Parkways Policy

DRAFT